

CM450111C

全自动意式浓缩咖啡机
Fully Automatic Espresso Machine

zh 使用说明书

使用产品前请仔细阅读本使用说明书，并请妥善保管

目录

主要用途	3	日常维护和清洁	23
重要安全信息	3	日常维护	23
环境保护	4	清洁奶泡系统	24
节能	4	清洁萃取单元	25
环保处理	4	保养程序	26
充分了解您的电器	5	清洁	26
供货清单	5	除钙	27
配置与组件	6	清洁和除垢	27
显示屏和操作控件	7	清空程序	28
功能选择旋钮位置	7	简单故障排除	29
符号	7	技术参数	31
颜色和显示	8		
自动开门	8		
附加信息 i 和 i [®]	8		
附件	8		
开启并关闭电器	9	更多产品、附件、更换部件以及服务信息请参见	
主开关	9	www.gaggenau.com 以及在线商店	
休眠模式	9	www.gaggenau.com/zz/store	
启用电器	9	嘉格纳售后服务热线: 400 828 0099	
启动电器	10	服务邮箱: careline.china@bshg.com	
首次设置	10		
设置水硬度	10		
净水滤芯	11		
带或不带过滤器使用电器	11		
插入滤水器	11		
请加水 and 加入咖啡豆	12		
制备饮料	13		
饮料选项	13		
使用咖啡豆制作咖啡	14		
同时制备两杯	14		
使用咖啡粉制作咖啡	15		
制备添加牛奶的咖啡饮料	15		
制备奶泡和热牛奶	16		
制备热水	16		
调整研磨度	17		
更换咖啡豆种类	17		
个性化饮品	18		
儿童锁	19		
启用儿童锁	19		
停用儿童锁	19		
出厂设置	20		
设置牛奶盒重量	22		
信息	22		

主要用途

拆开包装后请检查电器是否有损坏。如果电器在运输过程中损坏，请勿连接电器。

本电器仅供家庭使用。

仅限在室温及海拔 2000 米以下的室内使用本电器。

防止本电器结霜，否则其将可能受到损坏。

⚠ 重要安全信息

请仔细阅读使用说明书，遵照所述正确使用，并妥善保管。在将本电器移交他人使用时，应将使用说明书一并附上。

凡年满 8 岁或以上的儿童；身体、感官或智力有缺陷的人士以及缺乏相关经验和知识的人士，应在负责安全使用电器人员的监督或指导下，了解使用电器可能带来的危险后，方能使用本电器。请勿让 8 岁以下的儿童靠近本电器和电源线，且不得让儿童操作本电器。严禁儿童将本电器用于嬉戏。年满 8 岁的儿童必须在监督下，方能对本电器进行清洁或保养。

⚠ 警告 – 电击危险！

- 本电器只能通过正确安装的接地插座连接到交流电源。确保将电源插头连接到已正确安装接地保护的插座上。
- 务必按照铭牌上的技术规范连接和操作本电器。如果电器的电源线损坏，必须由客户服务人员进行更换。
- 若本电器或电源线遭到损坏，请勿强行使用。发生故障时，请立即拔除电源插头或关闭电源电压。
- 为杜绝意外发生，仅限由我们的客户服务人员进行维修。
- 切勿将本电器或电源线浸入水中。

⚠ 警告 – 磁性引起的危险！

本电器含有永久磁铁，会对心脏起搏器或胰岛素泵等电子植入物造成影响。请本身载有电子植入物的人距本电器和下列部件：奶罐、奶泡系统、水箱和萃取单元至少保持 10 厘米以上的距离。

⚠ 警告 – 有窒息危险！

严禁儿童玩耍包装材料。请妥善保管小零件，以避免儿童吞食。

⚠ 警告 – 有灼伤危险！

奶泡系统在使用后会变得很烫。应先待其冷却后再触摸。

⚠ 警告 – 有受伤危险！

- 电器不当操作可能导致受伤。
- 请勿将手伸入研磨器内。
- 关闭门时，请注意手指。

环境保护

节能

- 电器不使用时，请关闭电源。
- 设置自动关机的最短时间间隔数值。
- 尽量不要中断咖啡或奶泡分配的过程。提前中断某个程序，会增加能源的消耗，同时接水盘会更快装满。
- 定期为电器除垢，以免水垢蓄积。水垢的蓄积会增加能源消耗。

环保处理

按照环保要求处理包装材料。



本电器已经根据欧盟有关废弃电气和电子设备的法令 2012/19/EU (waste electrical and electronic equipment - WEEE) 进行了标记。该指令是在全欧盟范围内关于废弃设备回收处理和再生利用的有效法律依据。

请咨询经销商，了解现行处置方法。

充分了解您的电器

您可以在这里了解您的新电器。我们将向您说明控制面板和各个控件。此外，您还将获得有关附件的信息。

关于电器更多的信息，例如如何改变电器门打开角度等问题，请参见随附的安装说明书。

供货清单

(消费者专用)

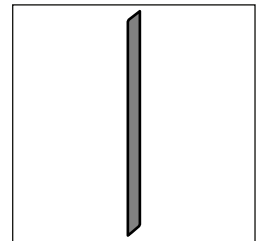
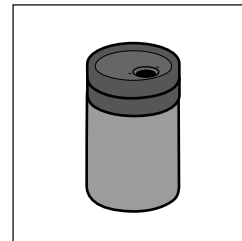
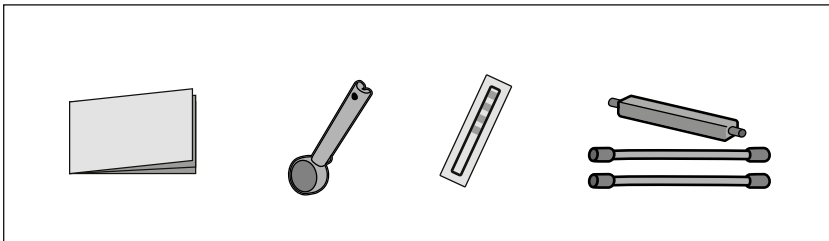
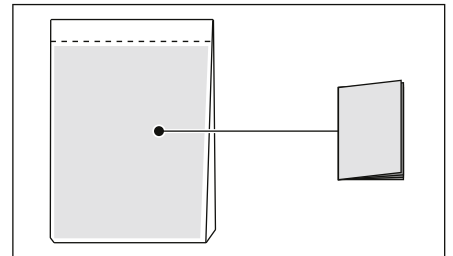
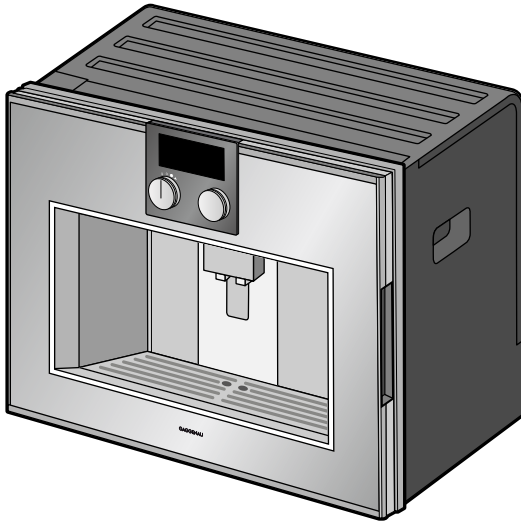

配置与组件

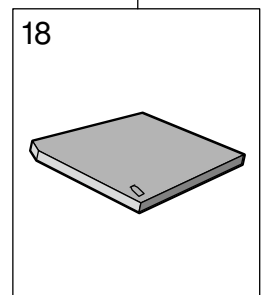
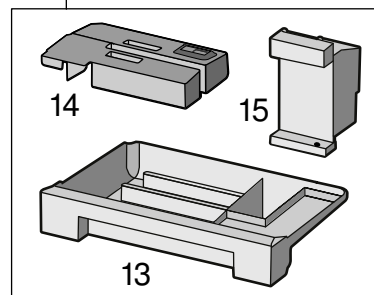
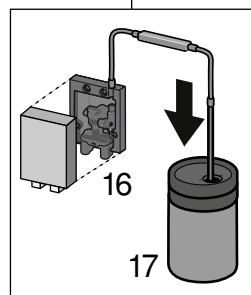
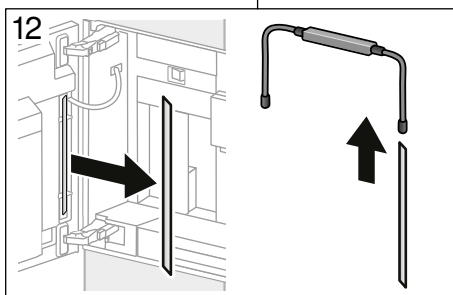
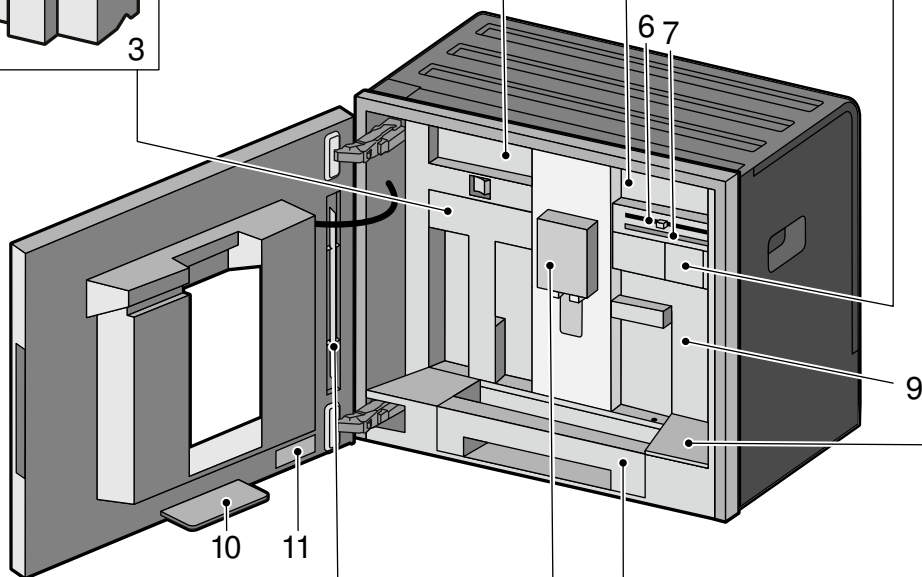
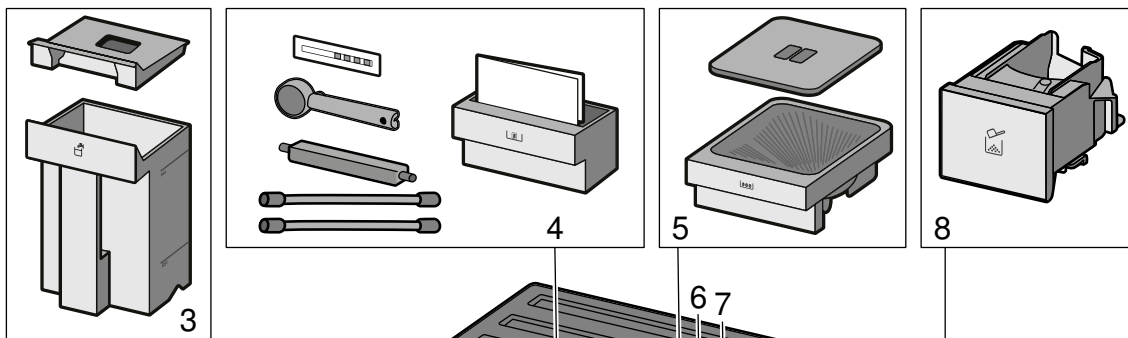
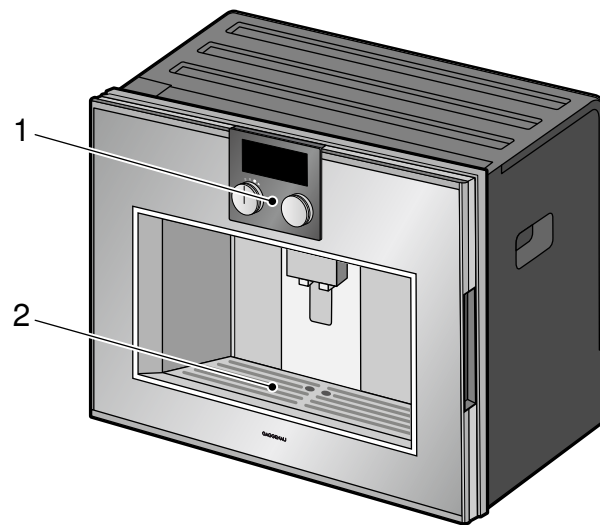

1	显示屏和控制件
2	用于杯子的搁放区
3	水箱 (含盖子)
4	附件收放处 (用于快速指南和附件)
5	豆箱
6	设置研磨度
7	磁架 (用于牛奶软管连接件)
8	咖啡粉盒
9	保护盖 (用于酿造单元)
10	水滴托盘
11	规格铭牌
12	固定件 (用于导奶管)
13	接水盘
14	接水盘盖
15	咖啡渣盒
16	饮料出口和奶泡装置, 高度可调
17	牛奶盒
18	牛奶盒搁放区 (秤重器), 可取下

显示屏和操作控件



1	控制面板	这些区域采用触摸式操作。触摸某个符号选择相应的功能。
2	显示	例如, 显示屏可显示当前的设置和选项。
3	旋钮	通过旋钮选择所需的饮料并执行其他设置。
4	功能选择旋钮	通过功能选择旋钮可以调用饮料或您所保存偏爱的饮料。

功能选择旋钮位置

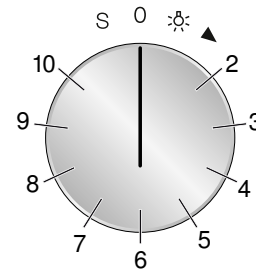

位置	功能
0	关闭位置
☀	灯光
2	饮料选项
3 - 10	个人化饮料的保存位置
S	保养程序 / 基本设置

符号

您可用于下列一览表查看操作电器时最常出现的符号。

符号	功能
▶	启动
■	停止
x	取消
✓	确认 / 保存设置
>	选择箭头
🔒	打开门
i	调用附加信息
🗨	调用额外提示
✎	编辑设置
📁	保存个人化饮料
🗑	容量快速选择
2份	2份饮料
🔒	儿童锁

颜色和显示

颜色

不同的颜色在各个相应的设定情况中作为用户指南。

橘色	首次设置 主功能、信息
蓝色	基本设置 清洁
白色	可设定值

图示

根据不同的情况，符号、数值和显示的图示将更动。

标准	刚刚所选的数值和符号将放大显示。
简洁的显示屏	一段时间后，显示屏显示将变得简洁，并仅显示最重要的信息。基本设置中的此功能在出厂默认设置下可启用和禁用。

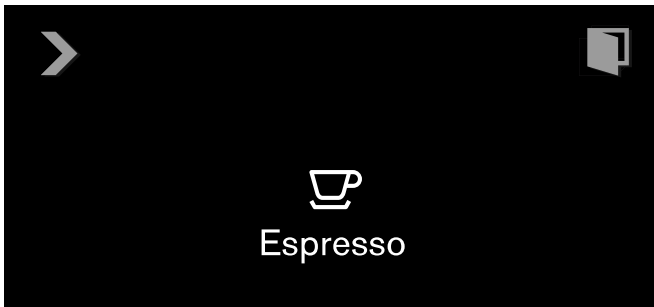

自动开门

当触摸  符号后，电器门将弹开，然后可抓住门上的嵌入式把手完全打开电器门。

如果开启了儿童锁或发生断电，自动开门功能将不起作用。可抓住门上的嵌入式把手将门打开。

附加信息 i 和 i^①

通过触按符号 i 可以调用额外的信息。

在操作过程中，您将获得先前冲泡饮料数量的信息。

将功能选择旋扭转到 S 的位置时，您将获得本电器何时必须进行除垢或清洁或者何时必须更换滤水器的信息。这些信息可用于选择待处理的保养程序。

有重要行动要求将显示符号 i^①。新的信息将额外显示在显示屏上持续几秒钟。这些信息将在数秒钟后自动熄灭或必须通过  进行确认。信息列表可以通过触按符号 i^① 显示。若所需的动作已被执行，该相应的信息旋即熄灭。

附件

全自动意式咖啡机有一个抽屉，可将快速指南或咖啡勺等附件放在电器内。打开门后，您可以使用磁架和各个部件夹（如牛奶软管组）。在电器门的内侧有导奶管的固定件。

本电器配备有以下一系列的附件：



咖啡勺
用于加入研磨咖啡。

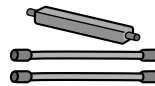

牛奶软管组
用于连接牛奶盒。



导奶管
用于插入牛奶盒、利乐包和牛奶瓶中或执行保养程序。



牛奶盒
容量为 0.5 升。
该牛奶盒是为了与此台全自动咖啡机一起使用而研发。仅供家用，可将牛奶存放在冰箱里。

以下附件可在之后向客户服务订购：

- 清洁片剂（订购号：00311769）
- 除垢片剂（订购号：00311819）
- 不锈钢牛奶盒（订购号：11005967）
- 开角度 92° 的限制件（订购号：00636455）
- 豆箱（含盖子）（订购号：11015223）

开启并关闭电器

主开关

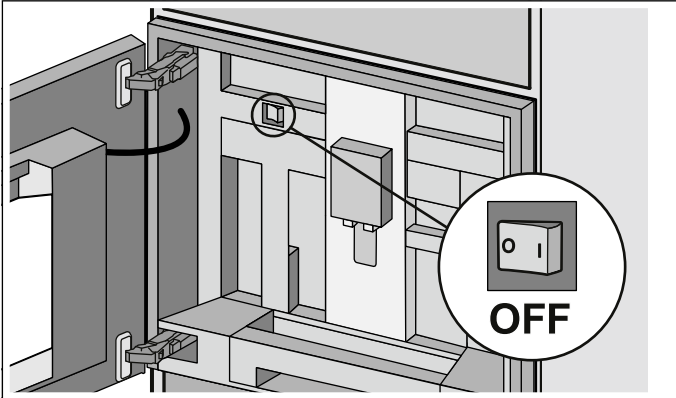

通过主开关开启并关闭本电器。

若本电器的主开关已关闭，电源即被关断。

本电器可进行编程，使其在 30 分钟后自动进入待机模式。此时间间隔可以更改。→ "出厂设置" 第 20 页

若本电器在主开关上被开启，其将自动进行清洗。例外：本电器已在几分钟前被关闭。

提示

- 请勿在操作期间按下主开关。您需要手动关机时，首先将功能选择旋转到 **0** 的位置，从而使本电器自动清洗。然后通过主开关关机。
- 本电器配备有传感器。电器上有牛奶盒时，将在切换为节能模式时（功能选择旋钮位在 **0** 的位置）在显示屏上出现相应的显示。若有牛奶在牛奶盒中，请将其放入冰箱保存。

休眠模式

若您将功能选择旋转到 **0** 的位置或启用儿童锁，本电器将进入休眠模式。

显示屏在休眠模式下的亮度将在头一分钟内降低。



然后显示屏将自行关闭。

提示

- 在基本设置中，您可以设置是否在休眠模式下显示嘉格纳标志。→ "出厂设置" 第 20 页
- 显示屏的亮度依垂直视角而定。您可以通过在基本设置中的 "亮度" 设置调整显示屏的亮度。

启用电器

如需退出休眠模式或启用关闭的显示屏，请转动功能选择旋钮。

这时您可以设置所需的功能。有关如何设置功能的信息，请参见相应的章节。

提示：未插入接水盘时，本电器无法开启，且不会有水从咖啡水嘴流出。

显示屏将显示 "请装上接水盘" 的信息。

启动电器

提示：仅限在无霜冻的地区使用该电器。如果在低于 0°C 的温度运输或存放此电器，必须等待至少 3 小时再使用电器。

本电器必须根据随附的安装说明书正确安装并连接，然后才能开机及操作。

首次设置

提示

- 电源接通后，将于首次开机时自动显示查询。
- 您可以随时更改设置。→ "出厂设置" 第 20 页

- 1 在主开关上开启电器。
显示屏将显示预设的语言。

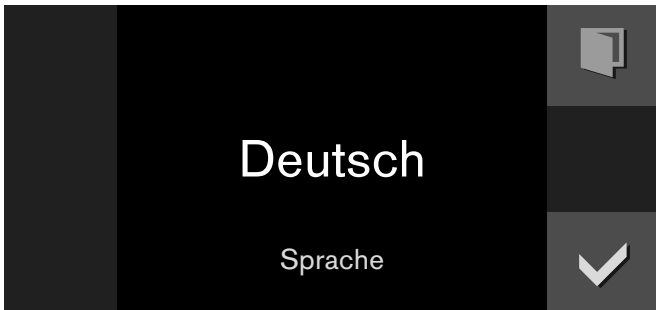

- 2 通过旋钮选择所需显示的语言。
- 3 通过 ✓ 确认。
显示屏将显示温度单位。
- 4 通过旋钮选择所需的温度单位。
- 5 通过 ✓ 确认。
显示屏将显示预设的容量单位。
- 6 通过旋钮选择所需的容量单位。
- 7 通过 ✓ 确认。
显示屏将显示预设的重量单位。
- 8 通过旋钮选择所需的重量单位。
- 9 通过 ✓ 确认。

显示屏将显示“完成初始设置”。通过 ✓ 确认。本电器已准备投入使用。

提示：切换语言时，系统将重新启动，这个过程需要几秒钟的时间。

设置水硬度

正确设置水硬度非常重要，这样电器才能适时显示何时应进行除垢程序。预设的水硬度级别是 4，若家中有安装软水装置，请设置“软水装置”。您可以使用随机附送的试纸测试水的硬度或咨询当地的供水单位。

- 1 将随附的试纸快速浸入饮用水一下，抖落水珠，一分钟后试验结果将显示出来。
- 2 将功能选择钮转到 **S** 的位置。
- 3 通过旋钮选择“基本设置”并触按符号 ✓。
- 4 通过旋钮选择“水硬度”。
- 5 触按符号 _。
- 6 通过旋钮设置测量后的水硬度。
- 7 通过 ✓ 确认。

电器已保存最新的设定值。触按 **X** 退出基本设置。

净水滤芯

带或不带过滤器使用电器

您可以在带有或不带滤水器的情况下使用本电器。为使本电器的除垢显示正常运作，您必须在基本设置中设置是否需要使用滤水器。

- 1 将功能选择旋钮转到 **S** 的位置。
- 2 通过旋钮选择“基本设置”。
- 3 触按符号 ✓。
- 4 通过旋钮选择“滤水器”。
- 5 触按符号 _。
- 6 通过旋钮选择“可用”（带有滤水器）或“不可用”（不带滤水器”。
- 7 通过 ✓ 确认。
在“可用”的设置时，冲洗程序将启动，请根据显示屏的说明进行。
- 8 触按符号 × 以退出基本设置菜单。

插入滤水器

新的滤水器在插入后务必清洗。

- 1 将功能选择旋钮转到 **S** 的位置。
- 2 通过旋钮选择“更换滤芯”。
- 3 触按符号 ✓。
- 4 将滤水器插入水箱，并向水箱中加入水至“max”（最高）标记处。

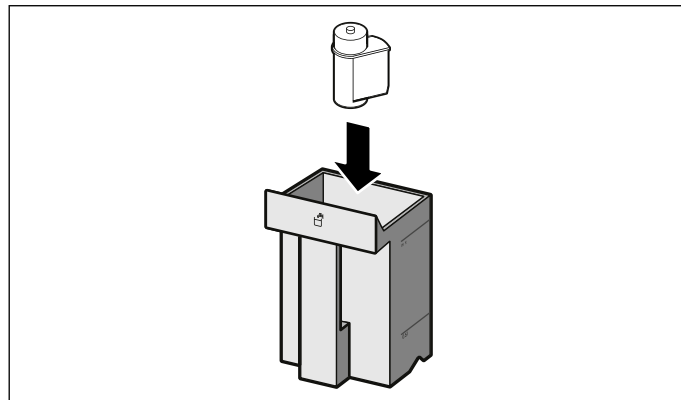

- 5 从牛奶盒拉出牛奶软管，并关上门。
- 6 将一个 0.5 升容量的容器放在咖啡水嘴的下方。
- 7 触按符号 ✓。

水先流经滤水器并对其进行清洗，然后流入容器内。清洗过程结束后，将通过 ✓ 确认，清空容器，本电器可再次投入使用。

清洗滤水器的同时会启用“更换滤水器”显示的设置。出现“请更换滤水器”的信息时或最迟两个月后，滤水器的作用便会耗尽。出于卫生考量，请更换滤水器，以防止电器出现水垢沉积（这可能损坏电器）。

新滤芯可向客户服务购得。→ “附件”第 8 页

提示：若本电器已有很长的一段时间未使用（例如外出度假），在使用前应先清洗使用中的滤水器。方法是冲制一杯热水即可。

请加水 and 加入咖啡豆

您可以使用您的电器制备来自新鲜现磨咖啡豆或咖啡粉的咖啡。请务必在饮料制备前才添加咖啡粉。→ "使用咖啡粉制作咖啡" 第 15 页

- 1 打开门。
- 2 取出水箱，并加入干净不含碳酸的冷水。重新插入水箱。

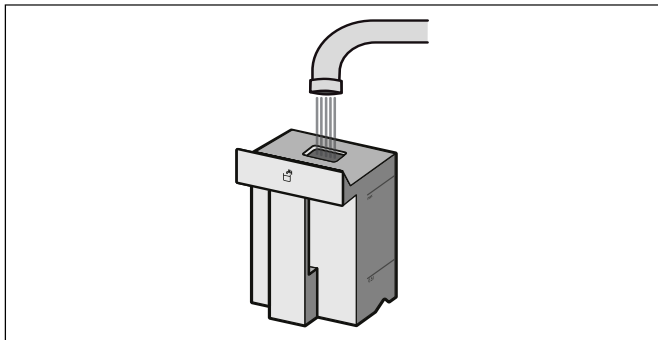

- 3 拉出豆箱，取下盖子并加入咖啡豆。将盖子盖回并重新插入豆箱。

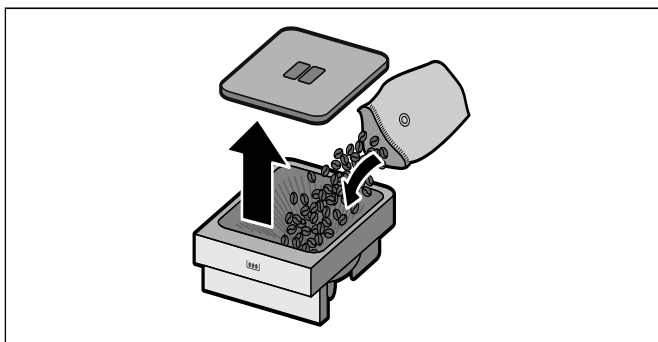

提示：请勿使用非常油、上了焦糖或加了含糖添加物的咖啡豆，因为这类咖啡豆容易堵塞酿造单元。仅限使用纯意式浓缩咖啡豆或全自动咖啡机使用的混合咖啡豆。

- 4 关上门。

制备饮料





饮料选项

提示

- 每次冲泡饮料时，内置风扇会自动开启，数分钟之后又自动关闭。
- 本电器于第一次使用、执行保养程序后或者长时间未使用再次使用时，第一杯咖啡完全不具香味，请勿饮用。
- 本电器的各项出厂默认设置均为呈现最佳性能而设计。
- 首次启动本电器后，将在冲泡数杯之后才会有厚实而稳定的“咖啡油脂”。

	意式超浓咖啡	浓缩咖啡。最好使用厚壁的小杯盛装。使用热水预热。
	意式浓缩咖啡	浓缩咖啡。最好使用厚壁小杯盛装。预先以热水预热杯子。
	咖啡	咖啡
	美式咖啡	1/3 意式浓缩咖啡，并加入 2/3 热水。
	热水	用于制备热饮（如茶）或预热杯子。
	奶泡	制备专属的白咖啡。
	热牛奶	作为饮料或加入至专属的咖啡饮料当中。
	白咖啡	1/2 咖啡 + 1/2 牛奶；最好使用厚壁小杯盛装。
	拿铁玛琪朵咖啡	特别盛在一个玻璃杯里，并且由三层组成：底层为热牛奶、中层为意式浓缩咖啡、上层为奶泡。
	浓缩白咖啡	意式浓缩咖啡加入奶泡。
	卡布奇诺咖啡	1/3 意式浓缩咖啡 + 1/3 牛奶 + 1/3 奶泡；最好以一只杯子盛装。
	浓缩玛琪朵咖啡	意式浓缩咖啡，加上一些奶泡点缀。

根据饮料可以选择其他选项：

	大小	小杯 - 中杯 - 大杯 - 超大杯
	浓度	非常淡 - 淡 - 中等 - 浓 - 较浓 - 特浓等，不适用于奶泡、热牛奶和热水
	温度	温热 - 烫 - 很烫，不适用于奶泡和热牛奶。选择热水时，可选择各种不同的温度。
	混合比例	设置牛奶比例，仅限加入牛奶的咖啡饮料。

“特浓”加倍香浓功能

咖啡酿造的时间越长，释放出的苦味和杂味越多。咖啡的味道和帮助消化的成分都因此受到影响。您的电器对于冲泡浓度非常强的咖啡因此使用了专门的加倍香浓功能。在咖啡制备一半份量时，重新将咖啡进行研磨并酿造，才能释放出宜人的、帮助消化的香浓成分。

特浓 3 ☉ 2 份的“特浓”加倍香浓功能仅限在一些设置上使用。在此设置中，咖啡将分两步骤进行制备。请等待冲泡程序完全结束。

使用咖啡豆制作咖啡

本电器必须开启。必须向水箱加水并加入咖啡豆。

1 将功能选择旋钮转到 2 的位置。

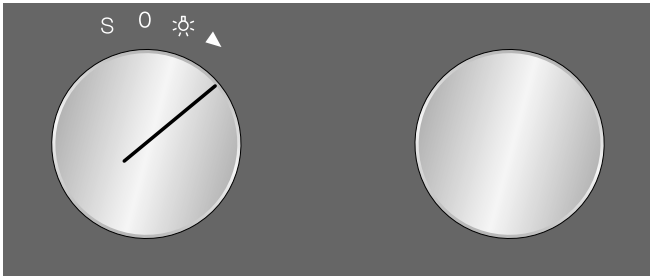

2 通过旋钮选择所需的饮料（如咖啡）。



3 将杯子放在咖啡水嘴下方。

4 触按符号 >。

5 通过旋钮设置大小。



6 触按符号 >。

7 通过旋钮设置浓度。



8 触按符号 >。

9 通过旋钮设置温度。



10 通过 ✓ 确认设置。

11 通过 ▶ 启动。

饮料已酿造好后随即流入杯内。

提示

- 冲制期间，符号 ■ 将显示。触按此符号以停止制备。
- 您可以通过符号 ↘ 保存当前的饮料：触按符号 ↘，将功能选择旋钮转到一个空的保存位置进行输入。
→ "个性化饮品" 第 18 页

同时制备两杯

您可以同时冲泡两杯饮料：

1 选择饮料，若有需要，通过旋钮进行温度设置。

2 触按符号 2 份。

3 在饮料出口下方放置两只杯子。

4 通过 ▶ 启动。

所选择饮料酿造好后随即流入杯内。

提示：咖啡将分两步骤进行制备。请等待冲泡程序完全结束。

使用咖啡粉制作咖啡



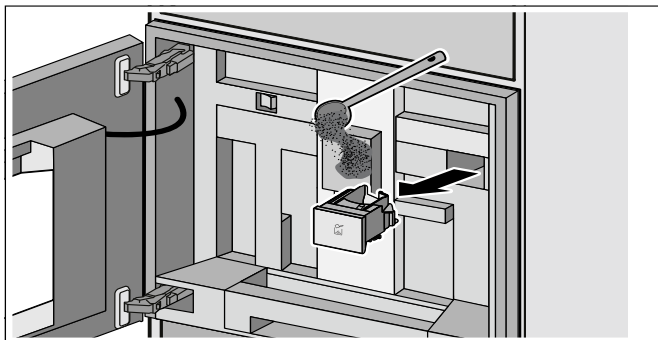

本电器必须开启，并向水箱中加入水。

重要： 请将杯子或玻璃杯移开，才能打开门，否则可能会倾倒。

- 1 将功能选择旋转到 2 的位置。
- 2 打开门。
- 3 最多将两平匙的咖啡粉倒入咖啡粉盒。关上咖啡粉盒。



提示： 请勿加入咖啡豆或即溶咖啡。

- 4 关上门。
- 5 通过旋钮选择所需的饮料（通过符号  标来自咖啡粉的饮料）。
- 6 将杯子放在咖啡水嘴下方。
- 7 触按符号 。
- 8 通过旋钮设置大小。
- 9 触按符号 。
- 10 通过旋钮设置温度。
- 11 通过  确认设置。
- 12 通过  启动。

饮料酿造好后随即流入杯内。如需另一杯咖啡，请重新加入咖啡粉，并重复这个过程。

提示

- 冲制期间，符号  将显示。触按此符号以停止制备。
- 若在 90 秒内没有冲泡咖啡的动作，酿造单元将自动排空，以免加注过量。
- 制备咖啡粉的咖啡时，加倍香浓功能以及同时制备两杯不可用。

制备添加牛奶的咖啡饮料

⚠ 警告 – 有灼伤危险！

奶泡系统在使用后会变得很烫。应先待其冷却后再触摸。

您可以将牛奶加入随附的牛奶盒或牛奶罐中，或者直接从利乐包中吸出牛奶。→ " 设置牛奶盒重量 " 第 22 页

重要： 请将杯子或玻璃杯移开，才能打开门，否则可能会倾倒。

使用牛奶盒：

- 打开门。
- 将饮料出口整个推至底部。
- 向前取下饮料出口的防尘盖。
- 将奶泡装置的牛奶软管固定在饮料出口上，并穿过上方开口向外。
- 将奶泡装置连接件固定在磁架（电器内部）上。
- 装有牛奶的牛奶盒将被放在靠近咖啡水嘴的右侧。将导奶管插入牛奶软管上，且将导奶管放入牛奶盒中。导奶管的端部必须浸在牛奶中。

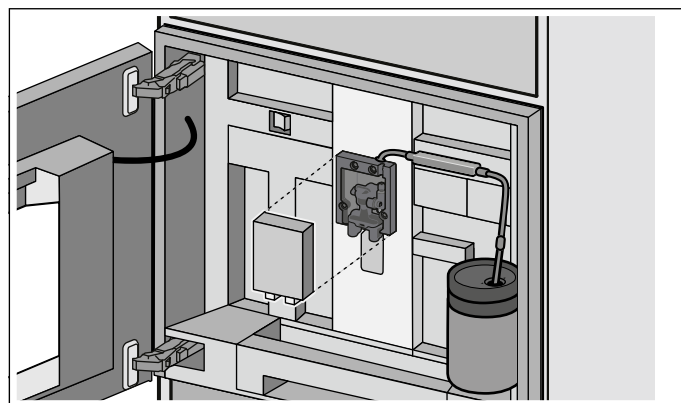

- 关上门。

利乐包或其他容器的使用方法如下：

- 打开门。
- 将饮料出口整个推至底部。
- 向前取下饮料出口的防尘盖。
- 将奶泡装置的牛奶软管穿过上方开口向外。
- 将磁架固定在电器上。
- 装有牛奶的利乐包将被放在靠近咖啡水嘴的右侧。将导奶管插入牛奶软管上，且将导奶管放入利乐包中。导奶管的端部必须浸在牛奶中。
- 关上门。

制备饮料：

本电器必须开启。必须向水箱加水并加入咖啡豆。

- 1 将功能选择旋转到 2 的位置。
- 2 通过旋钮选择加入牛奶的咖啡饮料。如需选择一杯来自咖啡粉的饮料，首先应将咖啡粉加入咖啡粉盒内。
- 3 将杯子或玻璃杯放置在咖啡水嘴下方。
- 4 通过 ▶ 启动。
- 或者 -
事先触按符号 >，通过旋钮设置大小或浓度并通过 ✓ 确认。

先吸出并制备牛奶，再酿造咖啡。

提示

- 冲制期间，符号 ■ 将显示。触按此符号以停止制备。
- 您可以通过符号 ↵ 保存当前的饮料：触按符号 ↵，将功能选择旋转到一个空的保存位置进行输入。
→ "个性化饮品" 第 18 页
- 干燥凝固后的牛奶残渣非常难清除，因此务必在每次使用后清洁奶泡装置。→ "清洁奶泡系统" 第 24 页

制备奶泡和热牛奶

⚠ 警告 – 有灼伤危险！

奶泡系统在使用后会变得很烫。应先待其冷却后再触摸。

制备饮料：

本电器必须开启。

- 1 将功能选择旋转到 2 的位置。
- 2 连接牛奶软管。→ "制备添加牛奶的咖啡饮料" 第 15 页
- 3 通过旋钮选择“奶泡”或“热牛奶”。
- 4 将杯子或玻璃杯放在咖啡水嘴下方。
- 5 触按符号 >。
- 6 通过旋钮设置份量。
- 7 通过 ✓ 确认设置。
- 8 通过 ▶ 启动。

牛奶将被吸出，然后再流入杯子或玻璃杯内。

提示

- 冲制期间，符号 ■ 将显示。触按此符号以停止制备。
- 您可以通过符号 ↵ 保存当前的饮料：触按符号 ↵，将功能选择旋转到一个空的保存位置进行输入。
→ "个性化饮品" 第 18 页
- 干燥凝固后的牛奶残渣非常难清除，因此务必在每次使用后清洁奶泡装置。→ "清洁奶泡系统" 第 24 页

制备热水

⚠ 警告 – 有灼伤危险！

奶泡系统在使用后会变得很烫。应先待其冷却后再触摸。

本电器必须开启，并向水箱中加入水。

- 1 从牛奶盒拉出牛奶软管。
- 2 将功能选择旋转到 2 的位置。
- 3 通过旋钮选择“热水”。
- 4 将杯子或玻璃杯放置在咖啡水嘴下方。
- 5 触按符号 >。
- 6 通过旋钮设置大小。
- 7 触按符号 >。
- 8 通过旋钮设置温度。
- 9 通过 ✓ 确认。
- 10 通过 ▶ 启动。

将水加热，然后流入杯子或玻璃杯内。

提示

- 冲制期间，符号 ■ 将显示。触按此符号以停止制备。
- 您可以通过符号 ↵ 保存当前的饮料：触按符号 ↵，将功能选择旋转到一个空的保存位置进行输入。
→ "个性化饮品" 第 18 页

调整研磨度

⚠ 警告 – 有受伤危险！

请勿将手伸入研磨器内。

通过研磨度滑块设置所需的咖啡粉细度，可在细研磨度（左）和粗研磨度之间（右）进行设置。

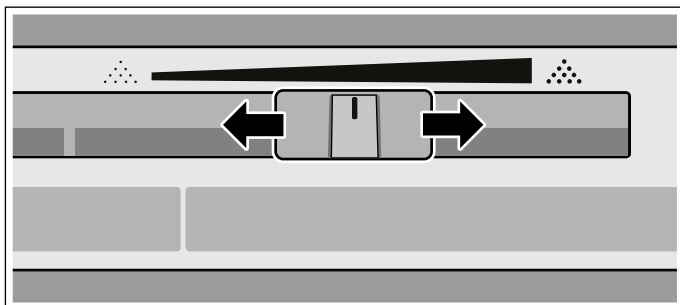

提示

- 新的设置在第二份咖啡后才会变得明显。
- 深色烘焙的咖啡豆适合磨细一点，浅色烘焙的咖啡豆才适合较粗的研磨度。
- 显示屏显示“将研磨度设置为粗磨”的信息，表示咖啡的研磨度太细。设置较粗的研磨度，因此应将滑块往右移。
- 研磨度的设置仅需小幅度更改。

更换咖啡豆种类

加入新的咖啡豆种类时，您可以使用清空研磨功能来清空放入了先前咖啡豆种类研磨机。

本电器必须开启。

- 1 取下豆箱并将咖啡豆清空。
- 2 加入新咖啡豆并重新插回豆箱。
显示屏将显示“豆箱内有新的咖啡豆种类”。
- 3 通过 ✓ 确认。

研磨机通过两次研磨过程将之前咖啡豆种类清空。

提示：若豆箱已插入，该信息将一直显示。若研磨机未被清空，只有在重新加入咖啡豆时，才能通过 ✕ 确认该信息。

个性化饮品

您可以设置并保存 8 个个人化饮料。

1 将功能选择按钮转到 8 个保存的位置。

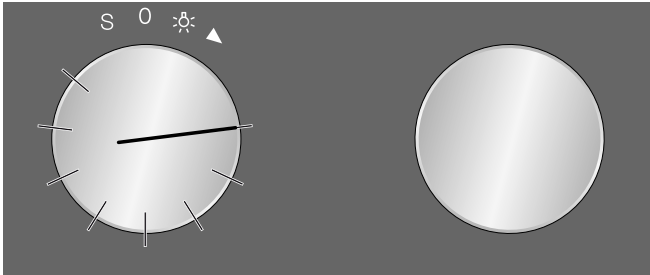

2 通过符号 > 先后选择所需的饮料、容量、浓度、温度和咖啡牛奶的比例，并通过旋钮进行设置。



3 在“ABC”下输入饮料名称。

旋钮	选择字母 新字开头的字母请务必大写。
>A [^]	按一下：将光标右移 按住：切换到变元音 按两下：插入新的一行
>Ä	按一下：将光标右移 按住：切换到正常字符 按两下：插入新的一行
⊗	删除字母



4 通过 ✓ 保存或通过 ✕ 中断并退出菜单。

5 通过 ▶ 启动。

咖啡豆将根据饮料的选择先进行研磨，然后制备牛奶，再酿造咖啡。

提示

- 冲制期间，符号 ■ 将显示。触按此符号以停止制备。
- 输入名称时，拉丁字母、某些特殊字符以及数字可用。
- 如需更改当前的保存位置，请触按符号 _ 进行新的设置。
- 选择一个已被占用的保存位置时，该设置将被覆写。

儿童锁

本电器配备了儿童锁，以防止儿童意外开启本电器。

提示

- 您必须在基本设置中将儿童锁设为“可用”，才可使用儿童锁。→“出厂设置”第 20 页
- 启用中的儿童锁遇到停电时，在恢复电力后儿童锁将被停用。

启用儿童锁

前提条件:

将功能选择旋钮转到 **0** 的位置。

触按符号  至少持续 6 秒钟。



儿童锁已被激活。符号  将在显示屏上方显示。

停用儿童锁

前提条件:

将功能选择旋钮转到 **0** 的位置。

触按符号  持续至少 6 秒钟。



儿童锁已停用。您可以一如往常设置本电器。

出厂设置

您的电器可在基本设置中单独调整。

- 1 将功能选择钮旋转至 **S** 位置。
- 2 用旋转选择钮选择“基本设置”。
- 3 触摸 ✓ 符号。
- 4 转动旋转选择钮，选择所需基本设置。
- 5 触摸 _ 符号。
- 6 使用旋转选择钮设定基本设置。
- 7 使用 ✓ 保存，或使用 ✕ 取消，退出当前基本设置。
- 8 将功能选择钮设置为 **0**，退出基本设置菜单。
更改被保存。

	基本设置	允许设置	说明
	亮度	级别 1、2、3、4、5*、6、7、8	设置显示亮度
	休眠模式	带有标志 * / 不带标志	带有或不带嘉格纳标志的休眠模式显示
	显示	简洁 * / 标准	如果选择了“简洁”设置，不久之后将仅显示最重要的信息。
	触控区颜色	灰色 * / 白色	为触控区的符号选择颜色
	触控区音调	音调 1* / 音调 2 / 关	选择触摸触控区时发出的声音
	触控区音量	级别 1、2、3、4、5*、6、7、8	设置触控区音调音量
	信号音音量	级别 1、2、3、4、5*、6、7、8	设置信号音的音量
	灯光模式	照明选项 1*-7	<ul style="list-style-type: none"> ○ 灯光关闭 ● 灯光开启 ▲ 灯光只有在冲泡饮料时才会打开。 通过触按符号 _ 打开其他设置选项。
	待机时间	5 分钟 - 12 小时	设置本电器在多久时间后自动刷新，并进入“待机模式”。
	水硬度	1-4*，软水装置	将随附的试纸快速浸入饮用水一下，抖落水珠，一分钟后试验结果将显示出来。设置测量后的水硬度。
	滤水器	可用 / 不可用 *	可用：操作带有滤水器的电器。 不可用：操作不带滤水器的电器。
	温度格式	°C* / °F	设置温度单位
	容量单位	ml* / fl.oz.	设置容量单位
	容量	+ / 5 ml 至 60 ml (0.2 fl.oz. 至 2 fl.oz.)	将容量匹配个性化杯子大小。首先选择饮料，然后设置容量。
	重量单位	g* / oz	设置重量单位
	牛奶盒重量	标准 * / 个性化设置	重量侦测设置。→ " 设置牛奶盒重量 " 第 22 页

	语言	German* / French / Italian / Spanish / Portuguese / Dutch / Danish / Swedish / Norwegian / Finnish / Greek / Turkish / Russian / Polish / Czech / Slovenian / Slovakian / Arabic / Hebrew / Japanese / Korean / Thai / 中文 / English US / English	选择文本显示语言 提示： 如果语言已更改，系统将会重新启动。这需要几秒钟的时间。同时关闭基本设置菜单。
	出厂设置	将电器重置到出厂设置	提问：“是否删除所有设置并恢复为出厂设置？”通过 <input checked="" type="checkbox"/> 确认或通过 <input type="checkbox"/> 取消。 提示： 重置到出厂设置时也会将个性化饮料删除。 重置到出厂设置后，您将进入“首次设置”菜单。
	演示模式	开 / 关 *	仅限用于演示目的。必须在正常操作下启用“关”的设置。该设置仅限在开机后头 3 分钟内才可进行。
	牛奶盒提示	30* 分钟 - 6 小时	设置在多久时间之后显示该提示。
	儿童锁	不可用 * / 可用	可用：儿童锁可被启用。→ “儿童锁”第 19 页







* 出厂设置

设置牛奶盒重量

为了在冲制拿铁玛奇朵咖啡时一直有足够的牛奶可供使用，本电器将依照重量侦测牛奶盒内的牛奶量。牛奶盒的牛奶过少时，将显示相应的信息。

随附空牛奶盒和空利乐包（约 30 克）的重量已经保存在“标准”下。本电器会自动侦测是否有使用牛奶盒或利乐包。您也可以在“个人化设置”的基本设置中保存自己的牛奶盒或利乐包的重量（若这与标准重量有差异）。

提示：牛奶盒内最多不得加入超过 2 公斤的牛奶重量。

- 1 将功能选择旋钮转到 **S** 的位置。
- 2 通过旋钮选择“基本设置”。
- 3 触按符号 .
- 4 通过旋钮选择“牛奶盒重量”。
- 5 触按符号 .
- 6 通过旋钮选择“标准”（预设牛奶盒重量）或“个人化设置”（自行输入牛奶盒重量）。
- 7 通过  确认。
- 8 在“标准”的设置时，本电器将自动退回到“基本设置”的选择级别
或者
在“个人化设置”的设置时，可以在此时对个人化牛奶盒称重，且其重量将被保存。
- 9 检查电器门后的牛奶盒区域是否清空，通过  确认。
- 10 在该区域放置一个空的容器（如牛奶罐），通过  确认。
- 11 关上门。
将对容器的重量进行称重并显示。
- 12 通过  确认。
更改已保存。
- 13 触按符号  退出“基本设置”菜单。

信息

根据在“基本设置”或冲泡加入牛奶饮料时的设置，显示屏可以显示不同的提示或信息：

“提示：牛奶是否还新鲜？”	将在设置时间后显示。 → “出厂设置”第 20 页 请检查牛奶盒内的牛奶是否新鲜。
“提示：将牛奶放入冰箱”	将在关机时显示。
“牛奶盒是否已连接好？”	信息将在选择加入牛奶的饮料后显示，请检查并确认。
“所选的饮料奶量不足”	若牛奶盒内未有足够的牛奶，将显示信息。

日常维护和清洁

日常维护

本电器将在每次开机或转到 **0** 的位置时自动清洗。例外：本电器已在刚刚几分钟前被关闭或在转到 **0** 的位置前未冲泡任何咖啡饮料。

警告 – 有电击危险！

请在清洁本电器前，关闭主开关。请勿将本电器浸泡在水中。请勿使用蒸汽清洁器。

注意！

表面损坏！

- 请勿使用任何含酒精或苯的清洁剂。
- 请勿使用摩擦型的布或清洁剂。
- 请立即去除水垢、咖啡、牛奶和除垢液残留物。这些残留物会导致腐蚀。
- 新的海绵抹布可能粘附有盐。盐会导致不锈钢产生锈膜，所以在使用海绵前请彻底清洗。

提示

- 请每天清空并清洁接水盘和咖啡渣盒，以防止污垢堆积。
 - 请立即清除搁放区的残留物，以防止污渍。
 - 电器已有很长一段时间（例如外出度假）未使用，请事先完全彻底清洁电器，包括奶泡装置、咖啡粉盒以及酿造单元。
- 1 请使用湿软布擦拭外壳。
 - 2 取下搁放区、打开门并将接水盘往前取下。
 - 3 取下盘盖、接水盘和咖啡渣盒。
 - 4 请清空、清洁以及晾干零部件。
 - 5 请以干净清洁的水冲洗水箱。
 - 6 取出咖啡粉盒，并用水冲洗，然后妥善晾干。
 - 7 请擦拭并晾干电器内部（接水盘和咖啡粉盒）以及水滴托盘。
 - 8 插入所有晾干部件（如咖啡粉盒）。

注意！

并非所有本电器的部件均可放入洗碗机洗涤。

不适合洗碗机洗涤的部件：



搁放区
附件抽屉
水箱（含盖子）
饮料出口防尘盖。
金属连接件
豆箱（含盖子）
咖啡粉盒
酿造单元的保护盖
酿造单元
牛奶盒

适合洗碗机洗涤的部件：



水温最高
60°C

水滴托盘
接水盘
接水盘盖
咖啡渣盒
牛奶软管
导奶管
饮料出口零部件
咖啡勺
牛奶盒盖子的零部件。
牛奶盒搁放区

清洁奶泡系统

制备加入牛奶的饮料后，将用短暂的空喷蒸汽自动清洁奶泡装置。

重要：奶泡装置应每周进行清洁，必要时也可以经常清洁。

⚠ 警告 - 灼伤危险！

饮料出口很烫。使用后应先让其冷却，然后才能触摸。

自动清洁奶泡装置

- 1 将功能选择旋转到 **S** 的位置。
- 2 通过旋钮选择“清洁奶泡装置”。
- 3 触按符号 ✓。
启动保养程序时，显示屏上的说明将引导您完成整个程序。
- 4 打开门。
- 5 从牛奶盒中取出并擦拭导奶管，并将导奶管的一端插入咖啡渣盒孔。

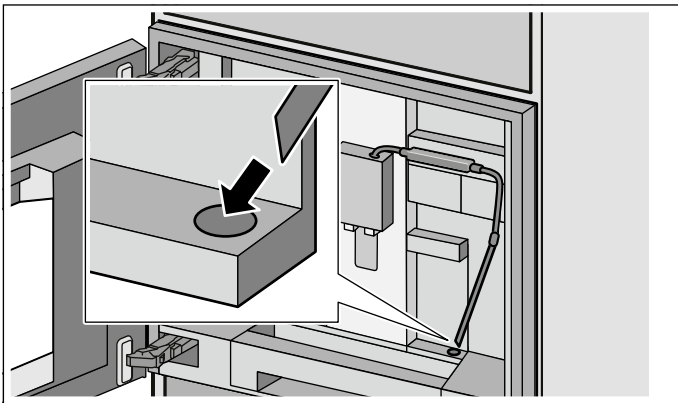

- 6 关上门。
- 7 请将 0.5 升容量的容器放置在饮料出口的下方。
- 8 触按符号 ▽。
该程序将运行约 1 分钟。
然后清空容器。
- 9 触按符号 ✓。
该程序已结束。

手动清洁奶泡装置

将奶泡装置拆卸清洁：

- 1 将饮料出口整个推至底部，然后将防尘盖向前取下。
- 2 按下饮料出口左侧的锁杆，便可将饮料出口向前拉出。

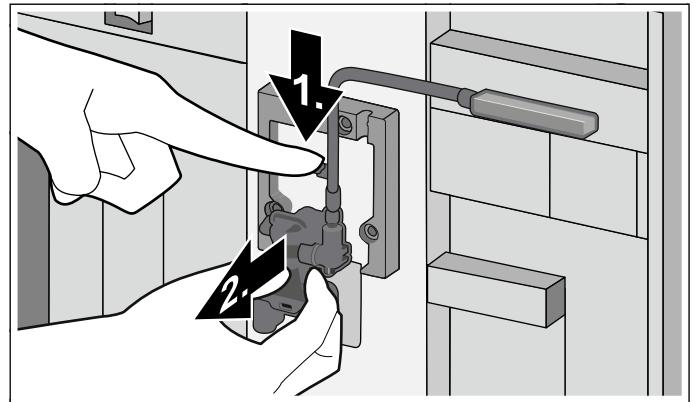

- 3 拉出牛奶软管 拆卸饮料出口的上下部件。

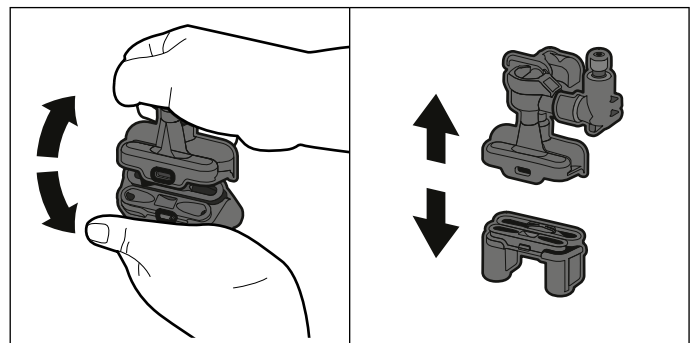

- 4 拆开牛奶软管、连接件以及导奶管。

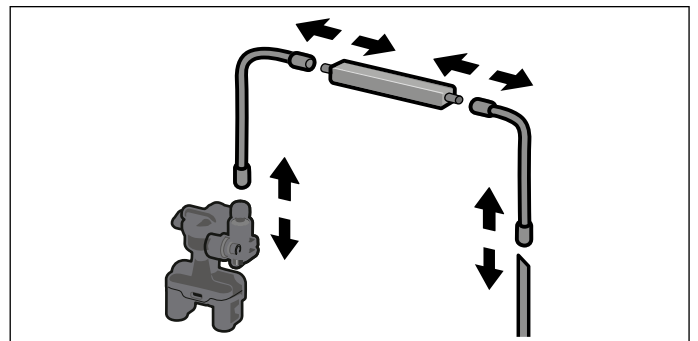

- 5 可使用洗涤液和软布清洁零部件。
- 6 将所有的部件用清水洗净并晾干。
- 7 将各部件重新组装起来（另参见快速指南）。

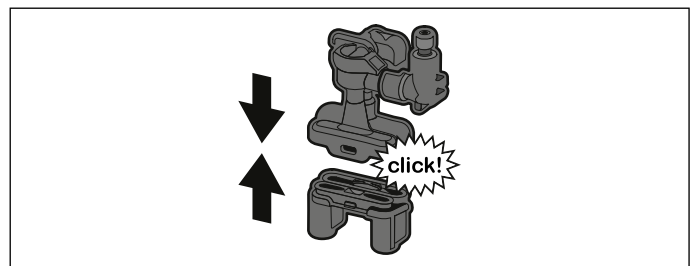

- 8 饮料出口直接从前面装回至三个接口固定。
- 9 重新装上防尘盖。

清洁牛奶盒

出于卫生考量，应定期清洁牛奶盒。只有盖子零部件适合放入洗碗机洗涤。请用手以温和的清洁剂清洗不锈钢牛奶盒。

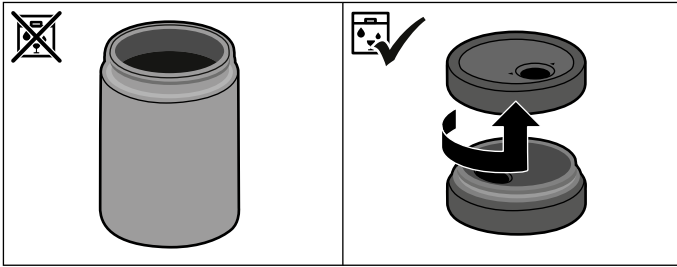

清洁萃取单元

(另见快速指南)

提示

- 除了使用自动清洁程序外，也应定期将酿造单元取出手动清洁。
- 请勿使用洗碗精或其他清洁剂清洁酿造单元，也不得放入洗碗机洗涤。

- 1 将功能选择旋转到 **0** 的位置。
- 2 打开门。
- 3 通过主开关关闭电器。
- 4 将保护盖从酿造单元上取下。
- 5 取出咖啡渣盒。
- 6 将酿造单元上的红色装置锁整个向左推至 **0** 的位置。
- 7 将弹出控制杆整个往下压。酿造单元将松开。
- 8 抓紧酿造单元的隐藏式把手并小心取下。
- 9 用水彻底清洁酿造单元。

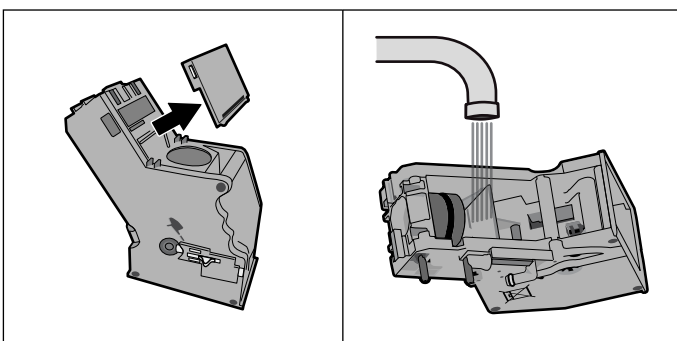

- 10 取下保护盖并在水龙头下清洁滤网。

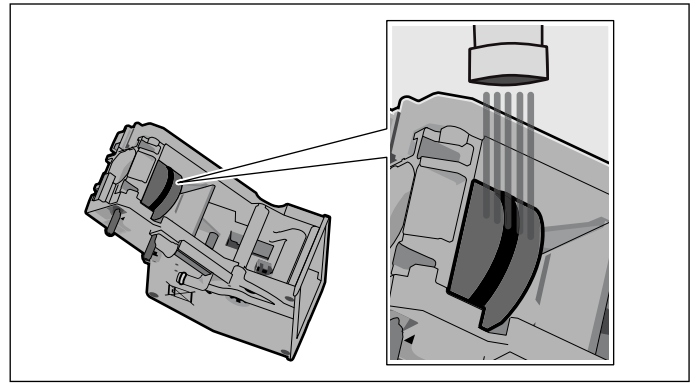

- 11 请彻底清洁酿造单元的连接销。

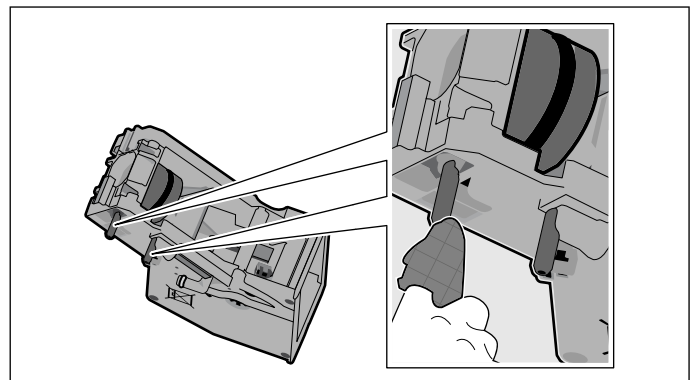

- 12 请彻底清洁电器内部，必要时清除当前的咖啡残留物。
- 13 让酿造单元和电器内部晾干。
- 14 重新装回保护盖。
- 15 将酿造单元推回本电器内，并按中央部位直至其卡紧为止。
重要：红色装置锁应在插入前整个推到最左边 **0** 的位置。
- 16 将弹出控制杆整个向上推，将红色装置锁整个向右推至 **0**。
- 17 装上咖啡渣盒。
- 18 重新盖上保护盖。
- 19 关上门。

保养程序

(另见快速指南)

根据水硬度和电器的使用情况，显示屏上将取代咖啡选择而定期出现以下的显示：

- 请更换滤水器
- 请清洁
- 请除垢
- 请除垢和清洁

紧接着将亮起警示符号 i° 。

随后应立即采取相应的程序，更换滤水器或以相应的程序对电器进行清洁或除垢。否则本电器将受到损坏。

此保养程序也可在没有显示屏的要求下随时启动。将功能选择旋转到 **S** 的位置，选择并执行所需的程序。

提示

- **注意！** 请勿饮用清洁液或除垢液。避免清洁液或除垢液与皮肤接触。清洁片剂和除垢片剂可能引起中毒，请将其保存在儿童接触不到的地方。
- **重要：** 本电器除垢不正确时，将显示“电器已被锁定需要紧急执行除垢”。请在出现提示后立即执行除垢程序。若本电器被锁定，只能在完成除垢程序后重新操作。
- **注意！** 每次使用保养程序的除垢和清洁片剂时，请依照说明书上的指示使用并注意（相应）的安全注意事项。
- 请勿饮用任何程序所产生的液体。
- 切勿使用醋、含醋、柠檬酸或含柠檬酸的产品为您的电器除垢。
- 如需除垢和清洁，仅限使用合适的片剂。它们专为本电器所研发，可向客户服务购买。→“附件”第 8 页
- 请勿将除垢片剂或其他片剂放入咖啡粉盒内。
- 切勿中断保养程序。
- 启动保养程序前，请取出、清洁并重新插回酿造单元。清洗奶泡装置。
- 在完成每个保养程序后，请立即用柔软的湿布擦去除垢液的残留物。这些残留物会导致腐蚀。
- 新的海绵抹布可能粘附有盐。盐会导致不锈钢产生锈膜，所以在使用海绵前请彻底清洗。
- 保养程序其中之一发生中断（如通过电源故障）时，请按以下的步骤进行操作：
 - 1 冲洗水箱。
 - 2 加入并确认干净不含碳酸的水，直到“max”（最高）标记处。
该程序将启动并清洗本电器。所需时间约 2 分钟。
 - 3 请清空、清洁并重新插入接水盘。
- **注意！** 请勿饮用除垢液。

清洁

所需时间：约 5 分钟

启动保养程序前，应清洁酿造单元。→“清洁萃取单元”第 25 页

- 1 将功能选择旋转到 **S** 的位置。
- 2 通过旋钮选择“清洁程序”。
- 3 触按符号 \checkmark 。
启动保养程序时，显示屏上的说明将引导您完成整个程序。
- 4 请清空并重新插入接水盘和咖啡渣盒。
- 5 将清洁片剂放入咖啡粉盒，并关回抽屉。
- 6 关上门。
- 7 请将 0.5 升容量的容器放置在饮料出口的下方。
- 8 触按符号 \blacktriangleright 。
该程序将运行约 5 分钟。
- 9 请清空并重新插入接水盘。
- 10 触按符号 \checkmark 。

清洁程序已结束。

除钙

所需时间：约 21 分钟

- 1 将功能选择旋钮转到 **S** 的位置。
- 2 通过旋钮选择“除垢程序”。
- 3 触按符号 ✓。
启动除垢程序时，显示屏上的说明将引导您完成整个程序。
- 4 请清空并重新插入接水盘和咖啡渣盒。
- 5 取下滤水器（必要时）并触按符号 ✓。
- 6 请在空水箱中加入微温水至“calc”标记处（0.5 升），然后将一片除垢片剂溶解在水中。
- 7 从牛奶盒中取出并擦拭导奶管，并将导奶管的一端插入咖啡渣盒孔。

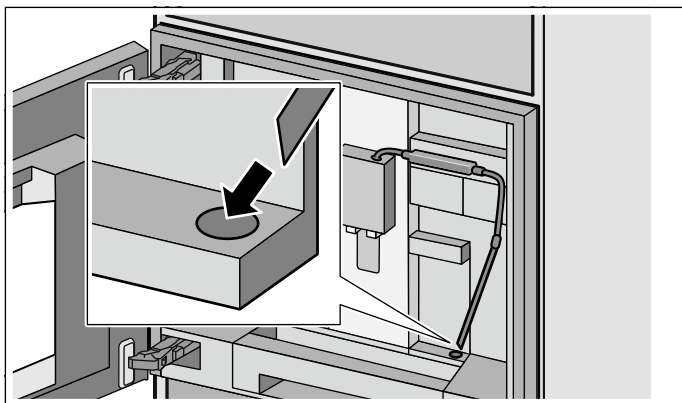

- 8 关上门。
- 9 请将 0.5 升容量的容器放置在饮料出口的下方。
- 10 触按符号 ▶。
此程序将运行约 19 分钟。
提示：水箱内的除垢液过少时，将显示“向水箱中加水 and 除垢剂”的信息。请在空水箱中加入微温水至“calc”标记处（0.5 升），然后将一片除垢片剂溶解在水中。通过 ✓ 确认。此程序将继续进行。
- 11 根据显示屏上的提示冲洗水箱，并加入干净的水至“max”（最高）标记处。若正使用一个滤水器，请在此时将其重新插入。
- 12 触按符号 ▶。
此程序将运行约 2 分钟并清洗本电器。
- 13 请清空并重新插入接水盘。
- 14 触按符号 ✓。
该程序已结束。
- 15 触按符号 ✓。
本电器已准备投入使用。

清洁和除垢

所需时间：约 26 分钟

清洁和除垢程序是将清洁和除垢的单一功能结合在一起。若两个功能的运行时间彼此皆很接近，本台全自动意式咖啡机将自动建议采用此保养程序。

启动保养程序前，应先清洁酿造单元。→“清洁萃取单元”第 25 页

- 1 将功能选择旋钮转到 **S** 的位置。
- 2 通过旋钮选择“清洁除垢程序”。
- 3 触按符号 ✓。
启动清洁除垢程序时，显示屏上的说明将引导您完成整个程序。
- 4 请清空并重新插入接水盘和咖啡渣盒。
- 5 请将一个清洁片剂投入咖啡粉盒内，并关回抽屉。
- 6 取下滤水器（必要时）并触按符号 ✓。
- 7 请在空水箱中加入微温水至“calc”标记处（0.5 升），然后将一片除垢片剂溶解在水中。
- 8 从牛奶盒中取出并擦拭导奶管，并将导奶管的一端插入咖啡渣盒孔。

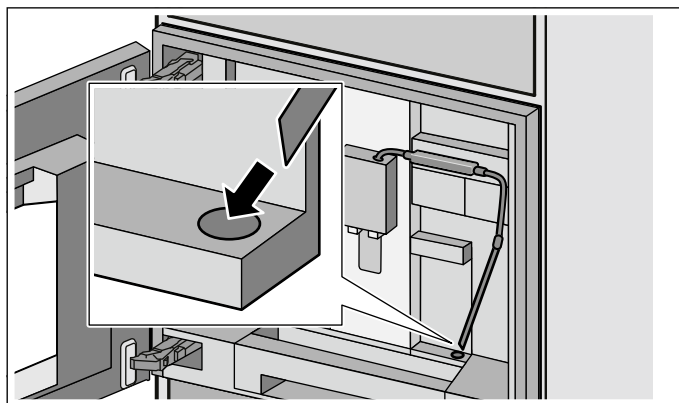

- 9 关上门。
- 10 请将 0.5 升容量的容器放置在饮料出口的下方。
- 11 触按符号 ▶。
此程序将运行约 19 分钟。
提示：水箱内的除垢液过少时，将显示“向水箱中加水 and 除垢剂”的信息。请在空水箱中加入微温水至“calc”标记处（0.5 升），然后将一片除垢片剂溶解在水中。通过 ✓ 确认。此程序将继续进行。
- 12 根据显示屏上的提示冲洗水箱，并加入干净的水至“max”（最高）标记处。若正使用一个滤水器，请在此时将其重新插入。
- 13 触按符号 ▶。
此程序将运行约 7 分钟并清洗本电器。
- 14 请清空并重新插入接水盘。
- 15 触按符号 ✓。
该程序已结束。
- 16 触按符号 ✓。
本电器已准备投入使用。

清空程序

清空程序是一种清除咖啡豆渣并避免运输或收纳时电器遭受霜冻损坏的保养程序。本电器必须开启。

- 1 将功能选择旋钮转到 **S** 的位置。
- 2 通过旋钮选择“清空程序”。
- 3 触按符号 ✓。
- 4 清空并重新插回豆箱。
- 5 必要时取下牛奶盒，然后关上门。
- 6 关上门。
该清空程序将运行约 2 分钟。
- 7 清空并重新插入水箱。
- 8 关上门。
该清空程序将运行约 2 分钟。
- 9 请取下并彻底清洁酿造单元。
- 10 触按符号 ✓。
- 11 请彻底清洁并重新插入接水盘、咖啡渣盒、奶泡装置和牛奶软管组。
- 12 关上门。

该清空程序已结束。

简单故障排除

问题	原因	故障排除
未达到个人设置的容量，咖啡流速成滴状或完全停流。	研磨度设置得太细。咖啡粉太细。	将研磨度设置为粗磨。使用较粗的咖啡粉。
	本电器结垢严重。	请按照说明书对电器进行除垢。→ " 保养程序 " 第 26 页
	酿造单元变脏。	清洁酿造单元。→ " 清洁萃取单元 " 第 25 页
热水尝起来有牛奶或咖啡的味道。	牛奶软管尚未取下。	从牛奶盒拉出牛奶软管。
	饮料出口有牛奶或咖啡的残渣。	清洁饮料出口。
煮出的咖啡无 " 咖啡油脂 "。	使用不适当的咖啡豆种类。	改用罗布斯塔含量较高的咖啡豆。
	咖啡豆不新鲜。	使用新鲜的咖啡豆。
	研磨度与咖啡豆不相配。	将研磨度设置为细磨。
咖啡太 " 酸 "。	研磨度设置得太粗。咖啡粉太粗。	将研磨度设置为细磨。使用较细的咖啡粉。
	使用不适当的咖啡豆种类。	请更换咖啡豆种类。
咖啡太 " 苦 "。	研磨度设置得太细。咖啡粉太细。	将研磨度设置为粗磨。使用较粗的咖啡粉。
	使用不适当的咖啡豆种类。	请更换咖啡豆种类。
咖啡尝起来有 " 焦味 "。	酿造温度太高。	降低温度。→ " 制备饮料 " 第 13 页
	研磨度设置得太细。咖啡粉太细。	将研磨度设置为粗磨。使用较粗的咖啡粉。
	使用不适当的咖啡豆种类。	请更换咖啡豆种类。
咖啡太淡。	选择的咖啡浓度太低。	提高咖啡浓度。→ " 制备饮料 " 第 13 页
	咖啡粉盒的咖啡粉堆积在一起。	取出咖啡粉盒，清洁并彻底晾干。
咖啡粉仍留在咖啡粉盒内。	咖啡粉粘在一起。	请勿在咖啡粉盒内将咖啡粉往下压。
	咖啡粉盒潮湿。	取出咖啡粉盒，清洁并彻底晾干。
水箱中的滤水器未固定到位。	滤水器安装不正确。	将滤水器垂直向下用力压入水箱接口。
豆箱在插入时卡住。	咖啡豆在外壳中。	取出咖啡豆。
咖啡渣未压实且过于潮湿。	研磨度设置得过细或过粗或使用的咖啡粉太少。	将研磨度设置为粗磨或细磨，或使用两平匙的咖啡粉。
研磨调整装置运行不平顺。	研磨机里太多咖啡豆。	冲泡一杯来自咖啡豆的饮料。更改研磨度，仅限较小幅度的调整。
酿造单元无法插入。	酿造单元的位置不正确。	请按说明书将酿造单元插入。→ " 清洁萃取单元 " 第 25 页
	酿造单元已锁定。	将酿造单元解锁。→ " 清洁萃取单元 " 第 25 页
酿造单元的保护盖无法正确安装。	酿造单元无法锁定。	锁定酿造单元。→ " 清洁萃取单元 " 第 25 页
接水盘底部有水，	有可能是冷凝水。	请勿插入没有装上盘盖的接水盘。
显示屏显示 " 牛奶盒是否已连接好？ " 虽然已连接牛奶盒。	牛奶盒不在传感器的侦测范围内。	请将牛奶盒放置在电器的右侧。
	未侦测到物料，如利乐包。	触按 " 是 " 确定显示屏的询问或使用随附的牛奶盒。
尽管已将牛奶加入至牛奶盒，但未冲泡牛奶。	导奶管插入牛奶盒的深度不够深。	请将导奶管插至牛奶盒的底部。
牛奶盒是空的，但未显示任何信息。	牛奶盒的搁放区 (秤重器) 变脏。	取下搁放区。请彻底清洁搁放区及其范围底部的面积。
显示屏显示 " 电压过大或不足 "。	电压过大或不足。	请与电力供应商或电力运营商联系。由受过训练的专业人员检查电源电压。
显示屏显示 " 请让电器冷却 "。	电器过热。	关闭电源 30 分钟。

问题	原因	故障排除
显示屏显示“故障: E0510”。	本电器出现故障。	请根据显示屏显示进行操作。
显示屏显示“请加入咖啡豆”。尽管已在豆箱加入咖啡豆, 但本电器未研磨任何咖啡豆。	咖啡豆没有掉入研磨机内(咖啡豆过油, 可能在豆箱内粘在一起)。	轻轻拍打豆箱。必要时, 请更换咖啡豆种类。用干布将空豆箱擦干净。
显示屏显示“取下酿造单元并清洗”。	酿造单元不干净。	清洁酿造单元。
	酿造单元内有过多的咖啡粉。	清洁酿造单元。最多倒入两平匙的咖啡粉。
	酿造单元的机件运行不平顺。	清洁酿造单元。→“清洁萃取单元”第 25 页
显示屏显示“重新加注不含碳酸的水或拆下滤水器”。	水箱插入错误。	请正确插入水箱。
	水箱内有含碳酸的水。	请将新鲜的自来水注入水箱内。
	浮球在水箱被卡住。	请取下水箱, 然后彻底清洁。
	若不遵循说明书清洗新的滤水器, 可能导致滤水器的耗损。	请根据说明书清洗滤水器并投入使用, 或重新使用新的滤水器。
	滤水器有气泡。	请将滤水器浸泡在水中一段时间, 直到无气泡逸出, 再将滤水器重新插入。
显示屏显示“清洗接水盘并更换”。	接水盘又脏又湿。	请将接水盘和滤网彻底清洁并晾干。
	关机时, 电器未侦测到已清空。	开机时, 请将接水盘取出并重新插入。
尽管已插好接水盘, 但显示屏上仍显示“请装上接水盘”。	电器内部(接水盘)不干净。	清洁电器内部。
	咖啡渣盒未完全插入卡紧。	请将咖啡渣盒插入卡紧。
取出接水盘后, 水滴在机器内的底部。	接水盘过早取下。	最后一次冲泡饮料后, 请等待数秒, 再将接水盘取下。
显示屏显示“关闭电器”	电器过热。	让电器冷却。
	酿造单元不干净。	请清洁酿造单元。
显示屏显示“联系售后服务”。	本电器出现故障。	请拨打热线电话。
若有任何问题, 请务必拨打热线电话!		

原产地: 斯洛文尼亚

总经销商:

博西家用电器(中国)有限公司

南京市中山路 129 号中南国际大厦 20、21 楼

执行标准:

GB 4706.1-2005

家用和类似用途电器的安全 第 1 部分: 通用要求

GB 4706.19-2008

家用和类似用途电器的安全 液体加热器的特殊要求

GB 4706.30-2008

家用和类似用途电器的安全 厨房机械的特殊要求

技术参数

电气连接 (电压 - 频率)	220-240 V ~, 50 / 60 Hz
电力负载:	1600 W
最大泵压 (静态)	19 bar
水箱的最大容量 (无滤水器)	2,4 l
豆箱的最大容量	500 g
电源线的长度	1,7 m
尺寸 (高 x 宽 x 深)	455 x 590 x 444 mm
重量, 空机	21-22 kg
研磨机的种类	陶瓷

产品中有害物质的名称及含量

部件名称	有害物质					
	铅 (Pb)	汞 (Hg)	镉 (Cd)	六价铬 (Cr(VI))	多溴联苯 (PBB)	多溴二苯醚 (PBDE)
印制电路组件	×	○	○	○	○	○
显示单元	×	○	○	○	○	○
电源线及连接线	×	○	○	○	○	○
电机、驱动部件及水泵	×	○	○	○	○	○
外壳	○	○	○	○	○	○
容器	○	○	○	○	○	○
食品加工部件	○	○	○	○	○	○
水加热系统	○	○	○	○	○	○
冲泡系统	○	○	○	○	○	○

本表格依据 SJ/T 11364 的规定编制。

○:表示该有害物质在该部件所有均质材料中的含量均在 GB/T 26572 规定的限量要求以下。

×:表示该有害物质至少在该部件的某一均质材料中的含量超出 GB/T 26572 规定的限量要求。

注意：上表包含了本公司生产的此类产品的全部部件，本产品的部件以实际配置为准。如您对此有任何疑问，请拨打本产品所提供的公司客服电话。

产品环保信息提示性说明

请按照产品说明书的要求使用和维护本产品，不当利用或处置本产品可能会对环境和人类健康造成影响。

依照国家《废弃电器电子产品回收处理条例》的有关规定，当您计划将此产品废弃时，请将其交给具有废弃电器电子产品处理资格的处理企业进行处理。产品中有毒有害物质含量信息参照上表。

Table of contents

Intended use	34
Important safety information	34
Environmental protection	35
Saving energy	35
Environmentally-friendly disposal	35
Familiarising yourself with your appliance	36
Included in delivery	36
Assembly and components	37
Display and operating controls	38
Function selector positions	38
Symbols	38
Colours and display	38
Automatic door opening	39
Additional information i and i [®]	39
Accessories	39
Switching the appliance on and off	40
Main switch	40
Hibernate mode	40
Activating the appliance	40
Setting up the appliance	41
Initial settings	41
Setting the water hardness	41
Water filter	42
Operation with or without a water filter	42
Inserting the water filter	42
Filling the water tank and bean container	43
Preparing beverages	44
Beverage selection	44
Preparing coffee using freshly ground beans	45
Preparing two cups at the same time	45
Preparing coffee using ground coffee	46
Preparing a coffee with milk	46
Preparing milk froth and warm milk	47
Preparing hot water	47
Setting the grinding level	48
Changing bean type	48
Individual beverages	48
Child lock	49
Activating the child lock	49
Deactivating the child lock	49
Basic settings	50
Setting the milk container weight	52
Messages	52

Daily care and cleaning	53
Daily maintenance	53
Cleaning the milk system	54
Cleaning the brewing unit	55
Service programmes	56
Cleaning	56
Descaling	57
Cleaning and descaling	57
Emptying programme	58
Simple troubleshooting	59
Technical data	61

Additional information on products, accessories, replacement parts and services can be found at www.gaggenau.com and in the online shop www.gaggenau.com/zz/store

Careline: 400-828-0099
Service E-mail: careline.china@bshg.com

Intended use

Check the appliance for damage after unpacking it. Do not connect the appliance if it has been damaged in transport.

This appliance is intended for domestic use only.

Only use the appliance indoors at room temperature and up to 2000 m above sea level.

Protect the appliance from frost, otherwise it will become damaged.

Important safety information

Please read carefully, follow and retain the operating instructions. When passing on the appliance, enclose these instructions.

This appliance can be used by children aged from 8 years and above and by persons with reduced physical, sensory or mental capabilities or lack of experience and knowledge if they have been given supervision or instruction concerning use of the appliance in a safe way and if they understand the hazards involved. Keep children under 8 years of age away from the appliance and connecting cable and do not allow them to use the appliance. Children shall not play with the appliance. Cleaning and user maintenance shall not be made by children unless they are older than 8 years and supervised.

Warning – Danger of electric shock!

- The appliance may only be connected to a power supply with alternating current via a correctly installed socket with earthing. Ensure that the protective conductor system of the domestic electricity supply has been correctly installed.
- Connect and operate the appliance only in accordance with the specifications on the rating plate. If the power cord of this appliance is damaged, it must be replaced by customer service.
- Do not use if the power cable or appliance is damaged. If a fault occurs, pull the mains plug or switch off the mains voltage immediately.
- To prevent hazards, the appliance may be repaired by our customer service only.
- Never immerse the appliance or mains cord in water.

⚠ Warning – Hazard due to magnetism!

The appliance contains permanent magnets which may affect electronic implants, e.g. heart pacemakers or insulin pumps. Persons wearing electronic implants must maintain a minimum distance of 10 cm from the appliance and from the following parts upon removal: milk container, milk system, water tank and brewing unit.

⚠ Warning – Risk of suffocation!

Do not let children play with packaging material. Store small parts safely as they can be easily swallowed.

⚠ Warning – Risk of burns!

The milk system becomes very hot. After use, allow it to cool down first before touching it.

⚠ Warning – Risk of injury!

- Improper use of this appliance may result in injury.
- Do not reach into the grinding unit.
- Be careful not to jam your fingers when closing the door.

Environmental protection**Saving energy**

- If the appliance is not being used, switch it off.
- Set the interval for automatic switch-off to the smallest value.
- If possible, do not interrupt coffee or milk froth dispensing. Stopping a process prematurely results in higher energy consumption and the drip tray fills up more quickly.
- Descale the appliance regularly to avoid a build-up of limescale. Limescale residue results in higher energy consumption.

Environmentally-friendly disposal

Dispose of packaging in an environmentally-friendly manner.



This appliance is labelled in accordance with European Directive 2012/19/EU concerning used electrical and electronic appliances (waste electrical and electronic equipment - WEEE). The guideline determines the framework for the return and recycling of used appliances as applicable throughout the EU.

Please ask your dealer about current disposal routes.

Familiarising yourself with your appliance

Use this section to familiarise yourself with your new appliance. The control panel and the individual operating controls are explained. You will also be informed about the accessories.

Further information about the appliance, such as how to change the opening angle of the door, can be found in the enclosed installation instructions.

Included in delivery

(For use)

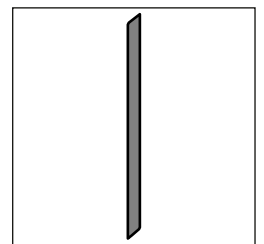
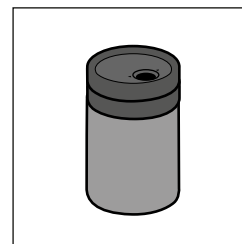
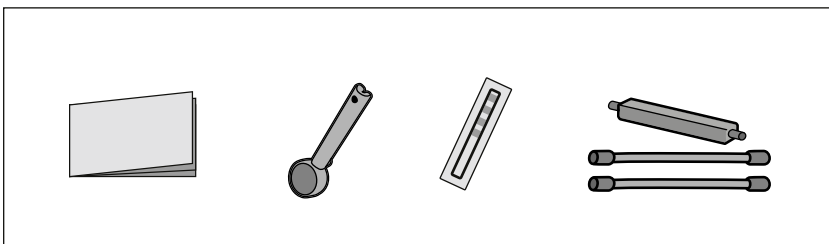
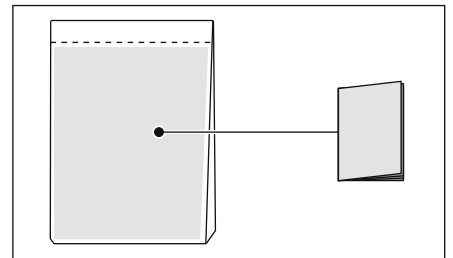
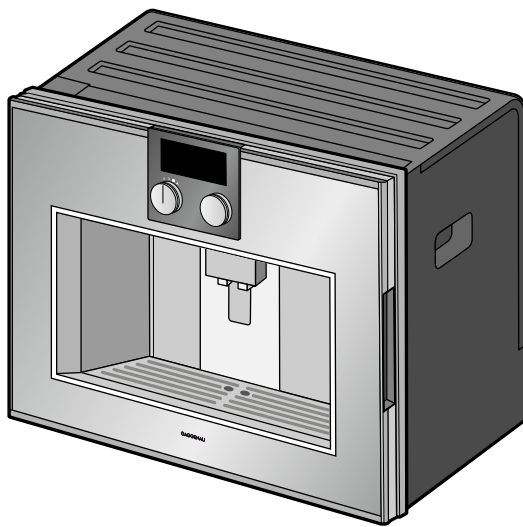

Assembly and components

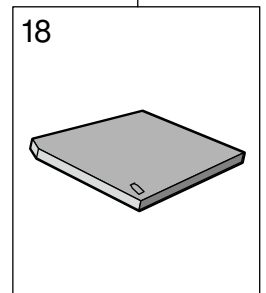
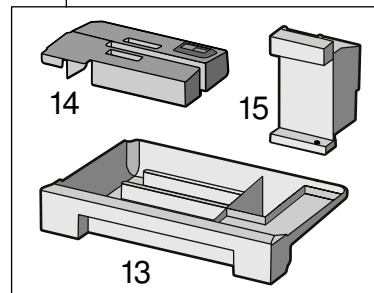
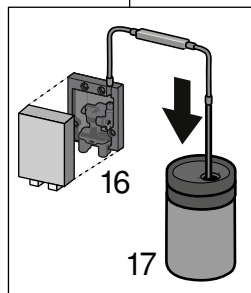
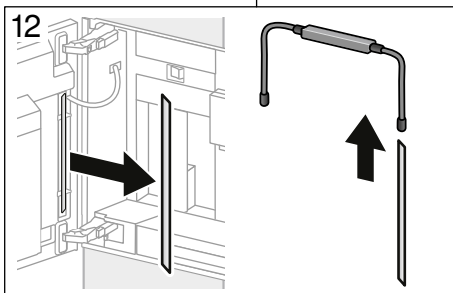
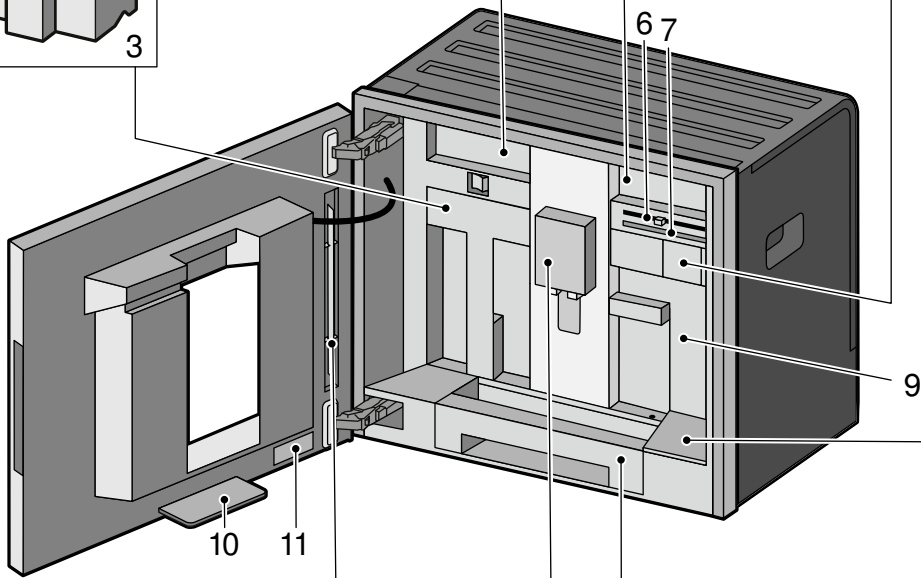
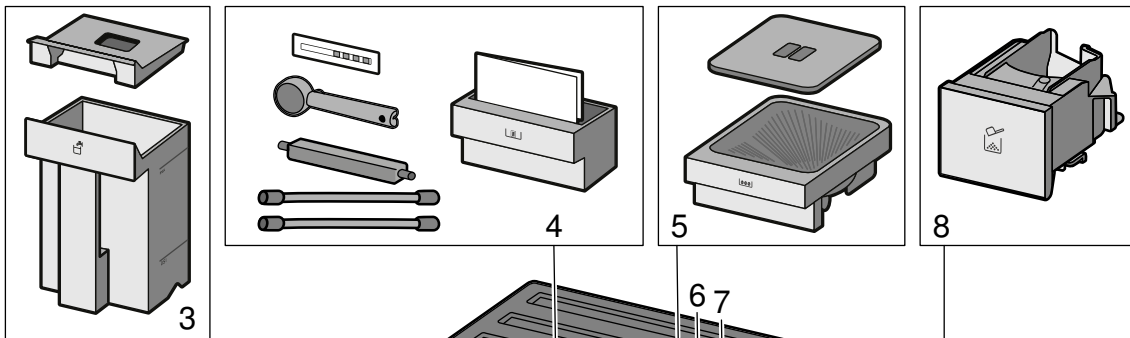
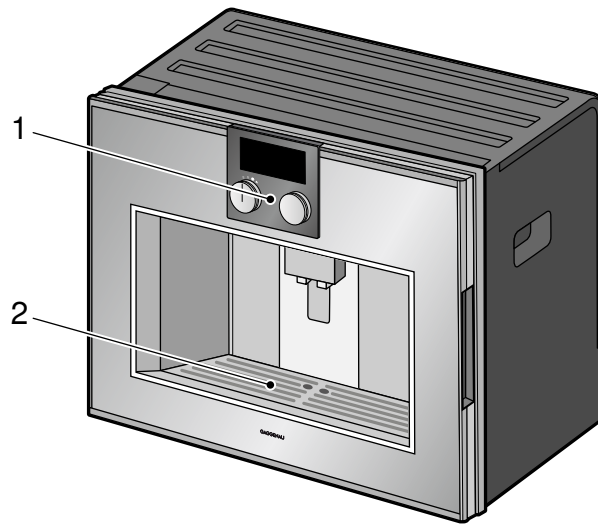

1	Display and controls
2	Shelf, e.g. for a cup
3	Water tank with cover
4	Accessory drawer (for quick reference guide and accessories)
5	Bean container
6	Grinding level adjustment
7	Magnetic holder (for milk hose connecting element)
8	Ground coffee drawer
9	Protective cover (for brewing unit)
10	Collecting tray
11	Rating plate
12	Holder (for milk tube)
13	Drip tray
14	Drip tray cover
15	Coffee residue container
16	Beverage dispenser and milk system, height-adjustable
17	Milk container
18	Shelf (scales) for milk container, removable

Display and operating controls

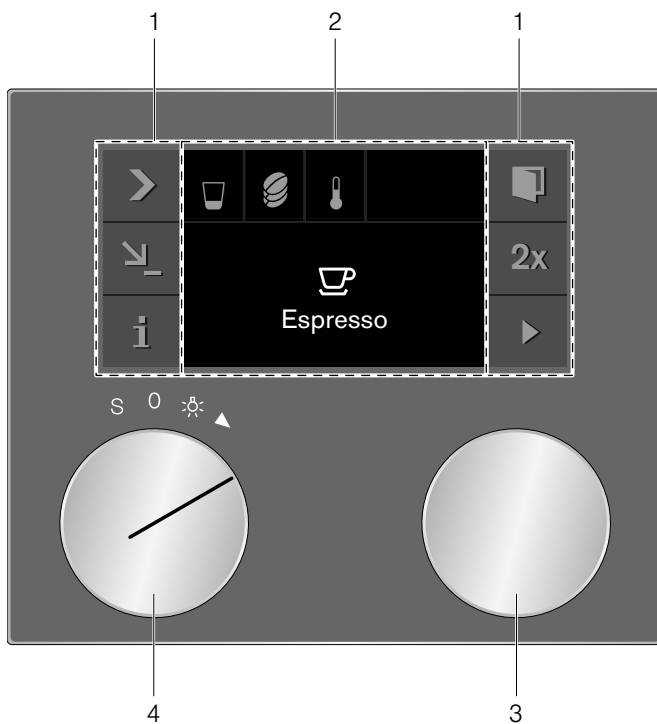

1	Control panel	These areas are touch sensitive. Touch a symbol to select the corresponding function.
2	Display	The display shows, for example, current settings and options.
3	Rotary selector	You can select the desired beverage and other settings using the rotary selector.
4	Function selector	You can use the function selector to call up beverages or the favourite drinks you have saved.

Function selector positions

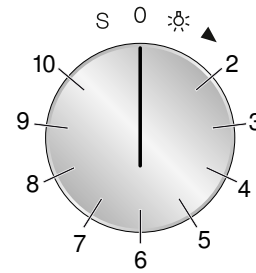

Position	Function
0	Zero setting
☼	Light
2	Beverage selection
3 - 10	Memory locations for individual beverages
S	Service programmes/basic settings

Symbols

The following overview details the symbols that are the most used when operating the appliance.

Symbol	Function
▶	Start
■	Stop
x	Cancel
✓	Confirm/save settings
>	Selection arrow
📖	Opening the door
i	Call up additional information
💬	Call up additional tips
🔧	Edit settings
📌	Save individual beverage
🗑️	Quick capacity selection
2x	2 beverages
🔒	Child lock

Colours and display

Colours

The different colours are used to guide the user in the relevant setting situations.

Orange	Initial settings
	Main functions, messages
Blue	Basic settings
	Cleaning
White	Adjustable values

Appearance

The symbols, values and displays may change, depending on the situation.

Standard	Values and symbols which have just been selected will be displayed in a larger font.
Reduced display screen	After a short while, the amount of information shown on the display will be reduced and only the most important information will remain. This function is activated in the basic settings ex works and can be deactivated.

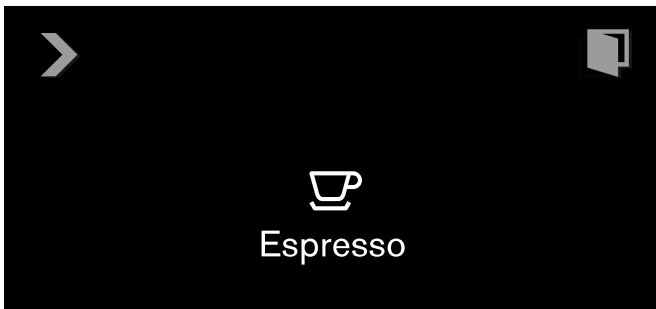

Automatic door opening

The appliance door springs open when you touch the  symbol and you can open it fully by using the recessed handle on the side.

Automatic door opening does not work if the child lock is activated or there is a power cut. You can open the recessed handle on the side by hand.

Additional information i and i[Ⓢ]

By touching the **i** symbol you can call up additional information.

During operation you will for example receive information about the number of beverages dispensed previously.

If the function selector is set to **S**, you will for example receive information about when the appliance needs to be descaled or cleaned, or when the water filter needs changing. You can use this information for example to start a service programme that is due soon.

The **i[Ⓢ]** symbol appears for important user prompts. New messages are also shown on the display for several seconds. These messages disappear automatically after a few seconds or must be confirmed with . A list of messages can be displayed by touching the **i[Ⓢ]** symbol. The message disappears when the required action has been carried out.

Accessories

The fully automatic espresso machine has a drawer for storing accessories such as the quick reference guide or measuring spoon inside the appliance. After opening the door, you can use the magnetic holder and the clip for the individual parts, such as the milk hose set. The holder for the milk tube is situated on the inside of the door.

The appliance includes the following accessories as standard:



Measuring spoon

For adding ground coffee.

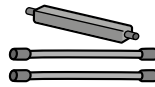

Milk hose set

For connecting the milk container.



Milk tube

For inserting into the milk container, milk cartons and milk bottles or for running a service programme.



Milk container

Volume capacity 0.5 litres.

The milk container has been designed especially for use together with this fully automatic coffee machine. It is intended solely for use in the household and for storing milk in the refrigerator.

The following accessories can be ordered by contacting the after-sales service:

- Cleaning tablets (order no.: 00311769)
- Descaling tablets (order no.: 00311819)
- Stainless-steel milk container (order no.: 11005967)
- Limit stop for 92° opening angle (order no.: 00636455)
- Bean container with lid (order no.: 11015223)

Switching the appliance on and off

Main switch

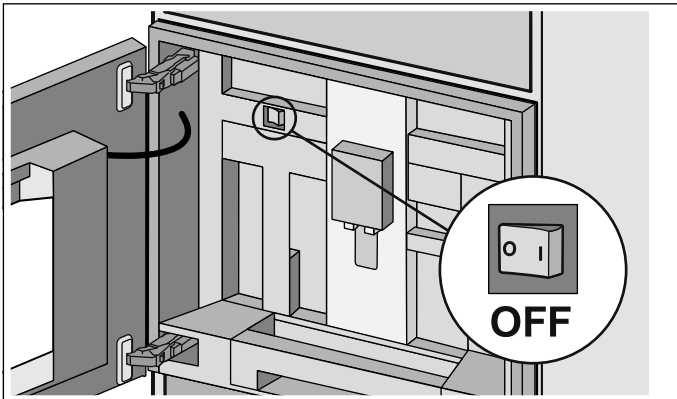

The main switch is used to switch the appliance on and off.

If the appliance is switched off at the main switch, the power supply is interrupted.

The appliance is programmed so that it switches to standby mode automatically after about 30 minutes. This timespan can be changed. → "Basic settings" on page 50

The appliance rinses automatically when it is switched on at the main switch. Exception: The appliance was only switched off a few minutes beforehand.

Notes

- Do not press the main switch during operation. If you want to manually switch off the appliance, you must first set the function selector to **0** so that it rinses automatically. Then switch off the appliance using the main switch.
- The appliance is equipped with a sensor. If a milk container is present, this will be shown on the display when switching to energy-saving mode (function selector set to **0**). If there is milk in the container, please keep in the refrigerator.

Hibernate mode

The appliance goes into hibernate mode if the function selector is turned to **0** or if the child lock is activated.

The brightness of the display is dimmed in hibernate mode during the first few minutes.



The display then switches itself off.

Notes

- In Basic settings, you can select whether the Gaggenau logo is to be displayed during hibernate mode. → "Basic settings" on page 50
- The brightness of the display depends on the vertical viewing angle. You can adjust the display using the "Brightness" setting in the basic settings.

Activating the appliance

To leave hibernate mode or to activate the display when it has been switched off, turn the function selector.

You can now set the desired function. You can read about how to set functions in the respective chapters.

Note: If no drip tray is inserted, the appliance cannot be switched on and no water will flow from the coffee dispenser.

The message "Insert trays" appears.

Setting up the appliance

Note: Only use the appliance in frost-free areas. If the appliance was transported or stored at temperatures below 0 °C, you must wait for at least 3 hours before using it.

Before the appliance can be switched on and used, it must be assembled and connected according to the enclosed installation instructions.

Initial settings

Notes

- The query appears automatically when first switched on after connection to a power outlet.
- You can change the settings at any time. → "Basic settings" on page 50

- 1 Switch on the appliance at the main switch. The preset language appears in the display.

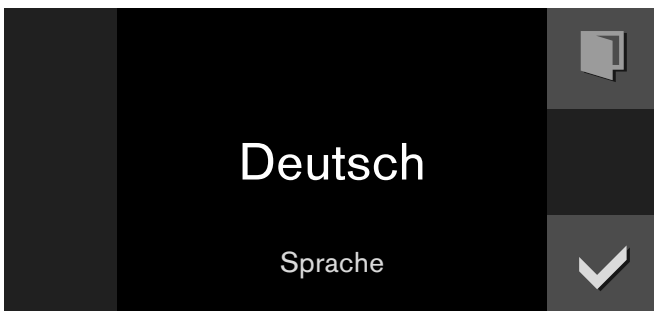

- 2 Turn the rotary selector to select the required display language.
- 3 Press ✓ to confirm. The temperature unit appears in the display.
- 4 Use the rotary selector to select the required temperature unit.
- 5 Press ✓ to confirm. The preset capacity unit appears in the display.
- 6 Use the rotary selector to select the required capacity unit.
- 7 Press ✓ to confirm. The preset weight unit appears in the display.
- 8 Use the rotary selector to select the required weight unit.
- 9 Press ✓ to confirm.

The display shows "Initial set-up complete".. Confirm with ✓. The appliance is now ready to use.

Note: If the language is changed, the system restarts. This takes a few seconds.

Setting the water hardness

It is important to set the water hardness correctly so that the appliance indicates in good time when the descaling programme should be run. The preset water hardness is level 4. If a water softening unit is installed in the household, select the "Softening device" setting. You can check the water hardness using the enclosed test strip or by asking your local water supplier.

- 1 Briefly immerse the enclosed test strip in fresh tap water, leave it to drip and read off the result after one minute.
- 2 Rotate the function selector to **S**.
- 3 Use the rotary selector to select "Basic settings" and touch the ✓ symbol.
- 4 Use the rotary selector to select "Water hardness".
- 5 Touch the _ symbol.
- 6 Using the rotary selector, set the measured water hardness.
- 7 Press ✓ to confirm.

The setting has been saved. Touch ✕ to exit the basic settings.

Water filter

Operation with or without a water filter

You can use the appliance with or without a water filter. To ensure that the descaling display of the appliance functions correctly, you must specify in the basic settings whether a water filter is used.

- 1 Rotate the function selector to **S**.
- 2 Select "Basic settings" using the rotary selector.
- 3 Touch the ✓ symbol.
- 4 Select "Water filter" using the rotary selector.
- 5 Touch the _ symbol.
- 6 Use the rotary selector to select either "Available" (with water filter) or "Not available" (without water filter).
- 7 Press ✓ to confirm.
The rinse program starts with the "Available" setting. Proceed according to the information on the display.
- 8 Touch the ✕ symbol to leave the Basic settings menu.

Inserting the water filter

New water filters must always be rinsed after being fitted.

- 1 Rotate the function selector to **S**.
- 2 Select "Water filter change" using the rotary selector.
- 3 Touch the ✓ symbol.
- 4 Fit the water filter in the water tank and then fill the tank with water up to the "max" mark.

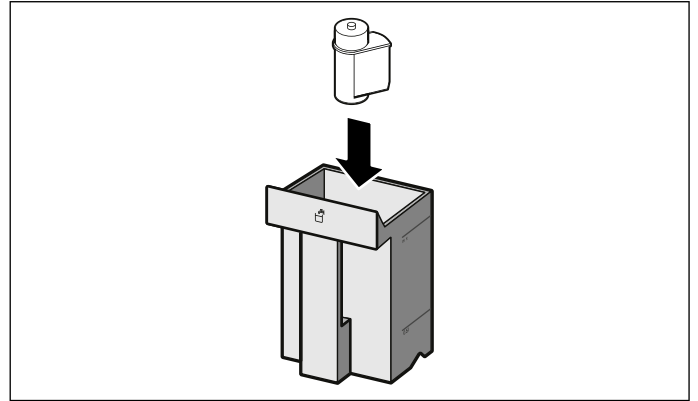

- 5 Remove the milk hose from the milk container and close the door.
- 6 Place a 0.5-litre container under the coffee dispenser.
- 7 Touch the ✓ symbol.

The water first runs through the filter to rinse it and then into the container. After the rinsing process, confirm with ✓ and empty the container. The appliance is again ready for use.

Rinsing the filter also activates the setting for the "Change water filter" display. When the display "Please change water filter" is shown, or at the latest after two months, the filter is no longer effective. It needs to be replaced for reasons of hygiene and so that the appliance does not experience a build-up of limescale (which could damage the appliance).

Replacement filters can be obtained from the after-sales service. → "Accessories" on page 39

Note: If the appliance has not been used for a long period of time (due to holidays, for example), the filter that is fitted should be rinsed before using the appliance. To do this, simply dispense a cup of hot water.

Filling the water tank and bean container

Using your appliance, you can prepare coffee using freshly ground coffee beans or ground coffee. Always only add ground coffee shortly before making a drink.

→ "Preparing coffee using ground coffee" on page 46

- 1 Open the door.
- 2 Remove the water tank and fill it with fresh, still, cold water. Reinsert the water tank.

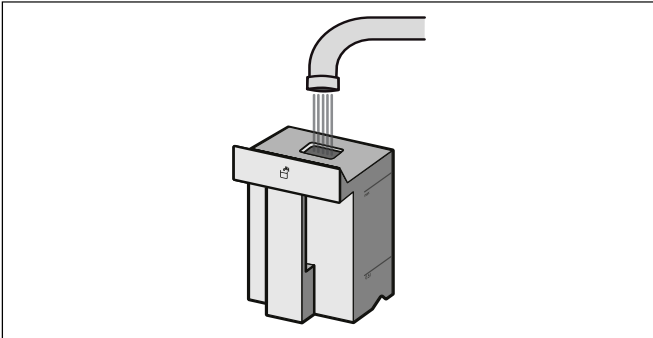

- 3 Pull the bean container out, remove the lid and fill the container with beans. Replace the lid and insert the bean container again.

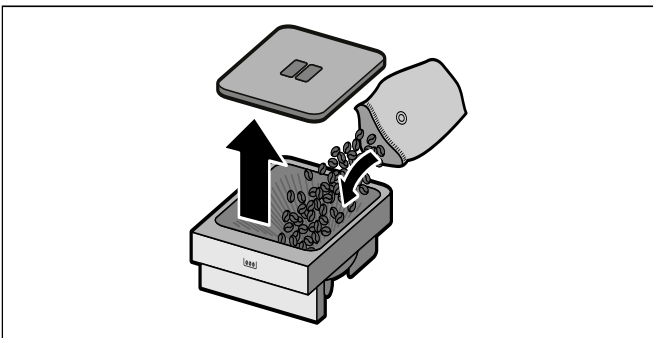

Note: Coffee beans that have been glazed or caramelised or that contain other sugary additives block the brewing unit. Only use pure bean mixes that are suitable for use in fully automatic espresso or coffee machines.













- 4 Close the door.

Preparing beverages





Beverage selection

Notes

- The integrated fan switches on each time a drink is dispensed and switches off again after a few minutes.
- When first using the appliance or when it has not been used for a long time, the first cup of coffee does not have the full aroma.
- The appliance is programmed with the standard factory settings for optimal performance.
- After starting the appliance for the first time, you will only consistently achieve a suitably thick and stable crema after the first few cups have been dispensed.

	Ristretto	Concentrated espresso. Best served in small, thick-walled cups. Preheat cups with hot water.
	Espresso	Concentrated coffee. Serve in small, thick-walled cups. Pre-heat cups with hot water.
	Coffee	Coffee
	Americano	1/3 espresso, is topped up with 2/3 hot water.
	Hot water	For preparing hot drinks, e.g. tea, or to preheat cups.
	Milk froth	For preparing speciality white coffees.
	Warm milk	As a beverage or as an ingredient in special coffee beverages.
	White coffee	1/2 coffee + 1/2 milk; best served in a wide-rimmed cup.
	Latte Macchiato	A specialty drink, served in a glass featuring three layers: at the bottom hot milk, in the middle espresso, and at the top milk froth.
	Flat White	Espresso with frothed milk.
	Cappuccino	1/3 espresso + 1/3 milk + 1/3 milk froth; best served in a cup.
	Espresso Macchiato	Espresso finished with milk froth.

You may be able to select further options depending on your choice of beverage:

	Size	Small - Medium - Large - Very large
	Strength	Very mild - Mild - Medium - Strong - Very strong - Extra strong etc., not available for milk froth, warm milk and hot water
	Temperature	Hot - Very hot - Extra hot not available for milk froth and warm milk Different temperatures can be selected for hot water.
	Mixing ratio	Setting for the proportion of milk, only available for coffee beverages with milk.

Aroma function "Extra strong"

The longer coffee is brewed, the more bitter substances and undesired aromas are released. This has a negative effect on the taste and makes the coffee less easily digestible. Your appliance therefore has a special Aroma function for very strong coffee. After half the requested volume has been prepared, coffee is ground and brewed once more, so that only the palatable and easily digestible flavours are released.

The Aroma function "Extra strong", e.g. "Extra strong 3 ☉ 2x" is only available for certain settings. The coffee is prepared in two stages with this setting. Wait until the process is fully completed.

Preparing coffee using freshly ground beans

The appliance must be switched on. The water tank and bean container must be filled.

- 1 Rotate the function selector to position 2.

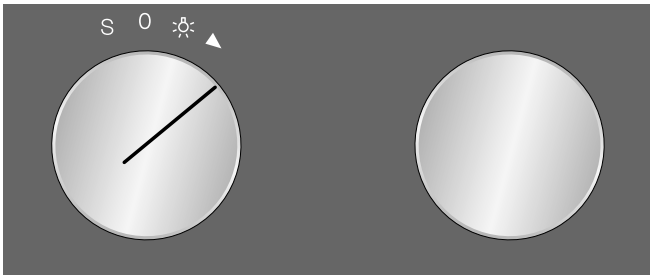

- 2 Use the rotary selector to select the desired beverage, e.g. coffee.

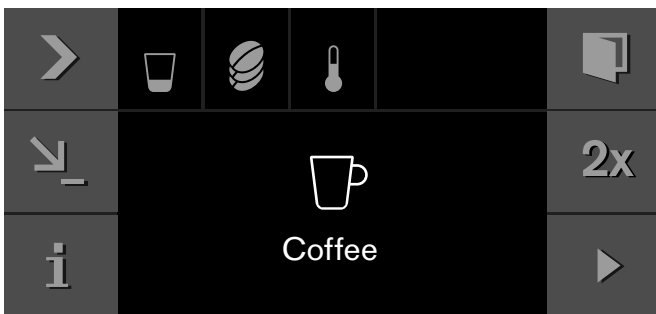

- 3 Place a cup under the coffee dispenser.
- 4 Touch the > symbol.
- 5 Set the size using the rotary selector.

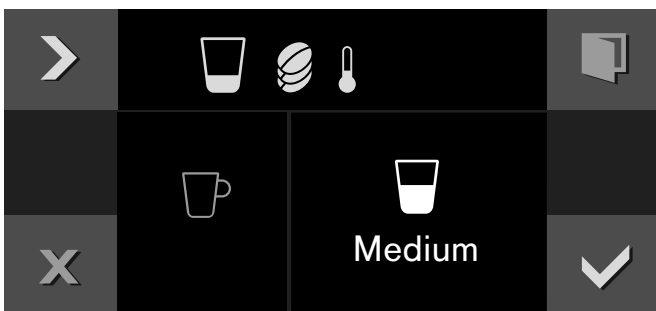

- 6 Touch the > symbol.
- 7 Set the strength using the rotary selector.

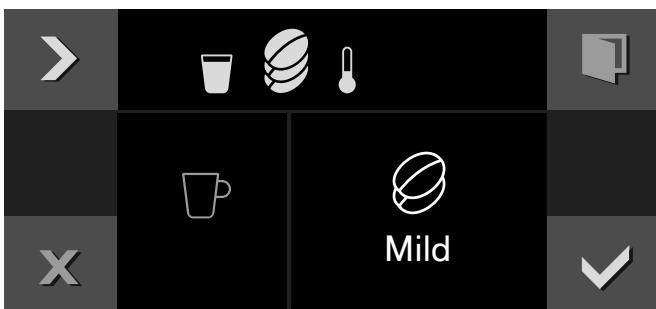

- 8 Touch the > symbol.

- 9 Set the temperature using the rotary selector.



- 10 Press ✓ to confirm the settings.
- 11 Press ▶ to start.

The beverage is brewed and then runs into the cup.

Notes

- While the beverage is dispensed, the ■ symbol is displayed. Touch this symbol to stop the beverage being prepared.
- Using the ↵ symbol, you can save the current beverage: Touch the ↵ symbol, turn the function selector to a free memory location and save the entry. → "Individual beverages" on page 48

Preparing two cups at the same time

You have the option of dispensing two beverages simultaneously:

- 1 Select the beverage and use the rotary selector to choose settings such as the temperature if desired.
- 2 Touch the 2x symbol.
- 3 Place two cups, or similar, underneath the beverage dispenser.
- 4 Press ▶ to start.

The beverage selected is brewed and then dispensed into the cups.

Note: The coffee is prepared in two stages. Wait until the process is fully completed.

Preparing coffee using ground coffee



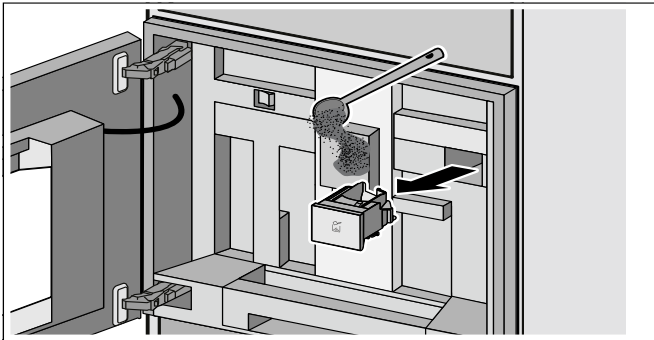

The appliance must be switched on and the water tank must be filled.

Important: Remove cups or glasses before opening the door as they may otherwise fall off.

- 1 Turn the function selector to position 2.
- 2 Open the door.
- 3 Using the measuring spoon, fill a maximum of two level spoonfuls of ground coffee into the ground coffee drawer. Close the ground coffee drawer.



Note: Do not fill the drawer with beans or instant coffee.

- 4 Close the door.
- 5 Use the rotary selector to select the desired beverage (beverages made from ground coffee are identified with the  symbol).
- 6 Place a cup under the coffee dispenser.
- 7 Touch the  symbol.
- 8 Set the quantity using the rotary selector.
- 9 Touch the  symbol.
- 10 Set the temperature using the rotary selector.
- 11 Confirm the settings using .
- 12 Press  to start.

The beverage is brewed and then runs into the cup. To prepare another cup, refill with ground coffee and repeat the process.

Notes

- While the beverage is dispensed, the  symbol is displayed. Touch this symbol to stop the beverage being prepared.
- If coffee is not dispensed within 90 seconds, the brewing chamber empties itself automatically to prevent an overflow.
- The Aroma function is unavailable when using ground coffee. Similarly, it is not possible to dispense two cups at once when using ground coffee.

Preparing a coffee with milk

Warning – Risk of burns!

The milk system becomes very hot. After use, allow it to cool down first before touching it.

You can decant the milk into the milk container supplied or fill e.g. into a milk jug or use the milk directly from the carton. → "Setting the milk container weight" on page 52

Important: Remove cups or glasses before opening the door as they may otherwise fall off.

Using the milk container:

- Open the door.
- Push the beverage dispenser down completely.
- Remove the cover of the beverage dispenser towards the front.
- Attach a milk hose from the milk system to the beverage dispenser and feed it outwards through the opening at the top.
- Attach the connecting element of the milk system to the magnetic holder (on the inside of the appliance).
- Place the filled milk container on the right next to the coffee dispenser. Connect the milk tube to the milk hose and then guide the milk tube into the milk container. The end of the milk tube must be immersed in the milk.

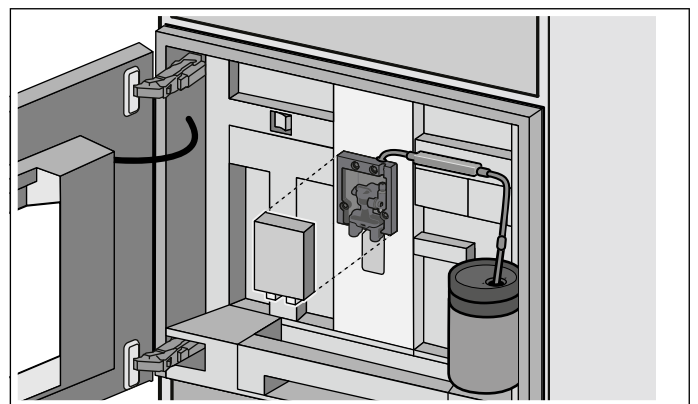

- Close the door.

Using a milk carton or other container:

- Open the door.
- Push the beverage dispenser down completely.
- Remove the cover of the beverage dispenser towards the front.
- Feed the milk hose of the milk system outwards through the opening at the top.
- Attach the magnetic holder to the appliance.
- Place the filled milk carton on the right next to the coffee dispenser. Connect the milk tube to the milk hose and then guide the milk tube into the milk carton. The end of the milk tube must be immersed in the milk.
- Close the door.

To prepare a drink:

The appliance must be switched on. The water tank and bean container must be filled.

- 1 Rotate the function selector to position 2.
- 2 Using the rotary selector, select a coffee beverage with milk. To select a beverage made with ground coffee, you must first fill the ground coffee drawer.
- 3 Place a cup or glass under the coffee dispenser.
- 4 Press ▶ to start.
- or -
Touch the > symbol first, then set the size or strength for example, using the rotary selector. Confirm with ✓.

The milk is drawn in and prepared and then the coffee is brewed.

Notes

- While the beverage is dispensed, the ■ symbol is displayed. Touch this symbol to stop the beverage being prepared.
- Using the ↘_ symbol, you can save the current beverage: Touch the ↘_ symbol, turn the function selector to a free memory location and save the entry. → "Individual beverages" on page 48
- Dried-on milk residues are difficult to remove, so always clean the milk system after every use. → "Cleaning the milk system" on page 54

Preparing milk froth and warm milk**⚠ Warning – Risk of burns!**

The milk system becomes very hot. After use, allow it to cool down first before touching it.

To prepare a drink:

The appliance must be switched on.

- 1 Rotate the function selector to position 2.
- 2 Connect the milk hose. → "Preparing a coffee with milk" on page 46

- 3 Select "Milk froth" or "Warm milk" with the rotary selector.
- 4 Place a cup or glass under the coffee dispenser.
- 5 Touch the > symbol.
- 6 Set the size using the rotary selector.
- 7 Press ✓ to confirm the settings.
- 8 Press ▶ to start.

The milk is drawn in and then flows into the cup or glass.

Notes

- While the beverage is dispensed, the ■ symbol is displayed. Touch this symbol to stop the beverage being prepared.
- Using the ↘_ symbol, you can save the current beverage: Touch the ↘_ symbol, turn the function selector to a free memory location and save the entry. → "Individual beverages" on page 48
- Dried-on milk residues are difficult to remove, so always clean the milk system after every use. → "Cleaning the milk system" on page 54

Preparing hot water**⚠ Warning – Risk of burns!**

The milk system becomes very hot. After use, allow it to cool down first before touching it.

The appliance must be switched on and the water tank filled.

- 1 Remove the milk hose from the milk container.
- 2 Rotate the function selector to position 2.
- 3 Select "Hot water" using the rotary selector.
- 4 Place a cup or glass under the coffee dispenser.
- 5 Touch the > symbol.
- 6 Set the size using the rotary selector.
- 7 Touch the > symbol.
- 8 Set the temperature using the rotary selector.
- 9 Press ✓ to confirm.
- 10 Press ▶ to start.

The water is heated and then flows into the cup or glass.

Notes

- While the beverage is dispensed, the ■ symbol is displayed. Touch this symbol to stop the beverage being prepared.
- Using the ↘_ symbol, you can save the current beverage: Touch the ↘_ symbol, turn the function selector to a free memory location and save the entry. → "Individual beverages" on page 48

Setting the grinding level

⚠ Warning – Risk of injury!

Do not reach into the grinding unit.

Using the slider for the grinding level, the desired fineness of the ground coffee can be set between a fine grinding level (left) and a coarser grinding level (right).

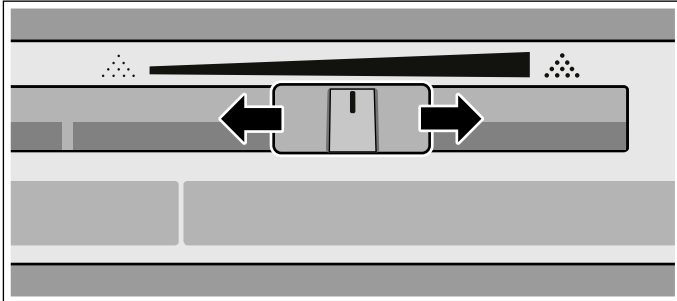

Notes

- The new setting only becomes noticeable after the second cup of coffee.
- Set a finer grinding level with dark-roasted beans and a coarser grinding level with lighter beans.
- If the display shows the message "Set coarser grinding level", the coffee beans are being ground too finely. Set a coarser grinding level. To do so, slide the slider to the right.
- Only make small changes to the grinding level setting.

Changing bean type

If you are using a new type of bean, the Empty grind function allows you to run the grinding unit until empty of your previous bean type.

The appliance must be switched on.

- 1 Remove the bean container and empty out the beans.
- 2 Add the new beans and reinsert the bean container. The message "New type of coffee beans in bean container?" appears.
- 3 Press **✓** to confirm.

The grinding unit is then emptied of your previous bean type in two grinding stages.

Note: This message always appears when the bean container is inserted. If you do not want to empty the grinding unit, e.g. when only refilling with beans, confirm with **X**.

Individual beverages

You can define and save instructions for up to 8 individual beverages.

- 1 Turn the function selector to one of the 8 memory locations.

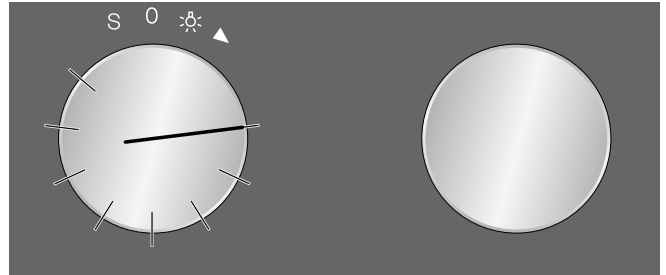

- 2 Use the **▶** symbol to successively select the desired beverage, size, strength, temperature and coffee-milk ratio and use the rotary selector to save the settings.



- 3 Enter the name of the beverage in "ABC".

Rotary selector	Selects letters A new word always begins with a capital letter.
>A	Press briefly: moves the cursor to the right Press and hold: shifts to umlauts and special characters Press twice: adds a line break
>Ä	Press briefly: moves the cursor to the right Press and hold: shifts to normal characters Press twice: adds a line break
X	Delete letters



- 4 Save with **✓** or cancel with **X** and exit the menu.
- 5 Press **▶** to start.

Depending on the beverage selected, the beans will be ground first, then the milk prepared and finally the coffee brewed.

Notes

- While the beverage is dispensed, the ■ symbol is displayed. Touch this symbol to stop the beverage being prepared.
- For entering a name, Latin characters, certain special characters and numbers are available.
- To change an existing memory location, touch the _ symbol and save a new setting.
- If a memory location which is already occupied is selected, the settings will be overwritten.

Child lock

The appliance has a child lock to prevent children operating it accidentally.

Notes

- You must set the child lock to "Available" in Basic settings. → "Basic settings" on page 50
- If there is a power failure while the child lock is activated, it may be deactivated when power is restored.

Activating the child lock

Prerequisite:

The function selector is set to 0.

Touch the  symbol for at least 6 seconds.



The child lock is now activated. The  symbol is shown at the top of the display.

Deactivating the child lock

Prerequisite:

The function selector is set to 0.

Touch and hold the  symbol for at least 6 seconds.





The child lock is deactivated. You can set the appliance as normal.















Basic settings









Your appliance can be individually adjusted in the basic settings.

- 1 Turn the function selector to **S**.
- 2 Select "Basic settings" using the rotary selector.
- 3 Touch the  symbol.
- 4 Turn the rotary selector to select the required basic setting.

- 5 Touch the  symbol.
- 6 Set the basic setting using the rotary selector.
- 7 Save with  or cancel with  and exit the current basic setting.
- 8 Turn the function selector to **0** to exit the basic settings menu.

The changes are saved.

	Basic setting	Permitted settings	Explanation
	Brightness	Level 1, 2, 3, 4, 5*, 6, 7, 8	Sets the display brightness
	Hibernate mode	with logo*/without logo	Hibernate mode display with or without GAGGENAU logo
	Display	Reduced*/Standard	If the 'Reduced' setting has been selected, only the most important information will be shown on the display after a short time.
	Touch field colour	Grey* / White	Selects the colour of the symbols on the touch fields
	Touch field tone	Tone 1* / Tone 2 / Off	Selects an audible signal for when a touch field is touched
	Touch field tone volume	Level 1, 2, 3, 4, 5*, 6, 7, 8	Sets the volume of the touch field tone
	Signal volume	Level 1, 2, 3, 4, 5*, 6, 7, 8	Sets the volume of the audible signal
	Light settings	Lighting options 1*-7	<ul style="list-style-type: none"> ○ Light off ● Light on △ Light only on when a beverage is being dispensed Other setting options will appear if you touch the  symbol.
	Standby after	5 minutes - 12 hours	Setting for the time after which the appliance automatically rinses and switches to standby mode.
	Water hardness	1-4*, softening device	Briefly immerse the enclosed test strip in fresh tap water, leave it to drip and read off the result after one minute. Set the measured water hardness.
	Water filter	Available/not available*	Available: Operating the appliance with a water filter. Not available: Operating the appliance without a water filter.
	Temperature unit	°C* / °F	Setting the temperature unit
	Capacity unit	ml/fl.oz.*	Set the capacity unit

	Capacity	+/- 5 ml to 60 ml (0.2 fl.oz to 2 fl.oz)	Adjust the capacity to individual cup sizes. First select the beverage and then set the capacity.
	Weight unit	g*/oz.	Set the weight unit
	Milk container weight	Standard*/Individual	Setting for weight detection. → "Setting the milk container weight" on page 52
	Language	German* / French / Italian / Spanish / Portuguese / Dutch / Danish / Swedish / Norwegian / Finnish / Greek / Turkish / Russian / Polish / Czech / Slovenian / Slovakian / Arabic / Hebrew / Japanese / Korean / Thai / Chinese / English US / English	Select language for text display Note: If the language is changed, the system restarts. This takes a few seconds. The basic settings menu is also closed.
	Factory settings	Reset the appliance to the factory settings	Confirm the question "Delete all individual settings made and reset to factory settings?" by pressing ✓ or cancel by pressing X. Note: Individual drinks will also be deleted if the appliance is reset to factory settings. After resetting the factory settings, the "Initial settings" menu is displayed.
	Demo mode	On / Off*	Only for demonstration purposes. The "Off" setting must be activated for normal operation. The setting is only possible in the first 3 minutes after switching on the appliance.
	Milk container reminder	30* minutes - 6 hours	Setting for the time after which the reminder appears.
	Child lock	Not available*/Available	Available: The child lock can be activated. → "Child lock" on page 49

* Factory setting

Setting the milk container weight

Using the weight, the appliance detects the quantity of milk in the milk container to ensure that there is always sufficient milk to dispense e.g. Latte Macchiato. If there is too little milk in the container, a corresponding message will be displayed.

The weight of the supplied empty milk container and that of an empty Tetra Pak carton (approx. 30 g) are already saved under "Standard". The appliance automatically detects whether the milk container or a Tetra Pak carton is being used. However, you can also save the weight of your own milk container or a Tetra Pak carton (if its weight deviates from the standard value) under the "Individual" setting.

Note: The container filled with milk must not exceed the maximum weight of 2 kg.

- 1 Rotate the function selector to **S**.
- 2 Select "Basic settings" using the rotary selector.
- 3 Touch the ✓ symbol.
- 4 Select "Milk container weight" with the rotary selector.
- 5 Touch the _ symbol.
- 6 Select "Standard" (preset milk container weight) or "Individual" (own weight input for the milk container) using the rotary selector.
- 7 Press ✓ to confirm.
- 8 With the "Standard" setting the appliance automatically reverts to the "Basic settings" selection level
or
With the "Individual" setting, your own milk container can now be weighed and the weight saved.
- 9 Check whether the area for the milk container behind the door is free. Confirm with ✓.
- 10 Place an empty container, e.g. a milk jug, in the area and confirm with ✓.
- 11 Close the door.
The weight of the container is determined and then displayed.
- 12 Press ✓ to confirm.
The changes are saved.
- 13 Touch the ✕ symbol to leave the "Basic settings" menu.

Messages

Depending on the setting in "Basic settings" or when dispensing a beverage with milk, various reminders or messages may be shown on the display:

"Reminder: Is the milk still fresh?"	Appears after a set time. → "Basic settings" on page 50 Please check whether the milk in the milk container is fresh.
"Reminder: Place milk in the refrigerator"	Appears when the appliance is switched off.
"Milk container connected?"	Message appears after selection of a beverage with milk. Please check and confirm.
"Not enough milk for the selected beverage"	Message appears when there is not enough milk in the milk container.

Daily care and cleaning

Daily maintenance

Every time the appliance is switched on or switched to **0**, it rinses automatically. Exception: the appliance was only switched off a few minutes beforehand or no coffee was dispensed before it was switched to **0**.

Warning – Danger of electric shock!

Before cleaning the appliance, switch it off using the main switch. Never immerse the appliance in water. Do not use a steam cleaner.

Caution!

Surface damage!

- Do not use any cleaning agents containing alcohol or spirits.
- Do not use abrasive cloths or cleaning agents.
- Always remove any residue of lime, coffee, milk and descaling solution immediately. This residue may cause corrosion to form.
- New sponge cloths may contain salts. Salts can cause rust film on stainless steel and must therefore be washed out thoroughly before use.

Notes

- The drip tray and coffee residue container should be emptied and cleaned every day to prevent deposits.
- Immediately remove residues from the shelf to avoid stains.
- If the appliance has not been used for a long time (e.g. while you are on holiday), clean the entire appliance thoroughly, including the milk system, ground coffee drawer and brewing unit before using.

- 1 Wipe the housing with a soft, damp cloth.
- 2 Remove the shelf, open the door and pull out the drip tray to the front.
- 3 Remove drip tray, cover and coffee residue container.
- 4 Empty, clean and dry the individual parts.
- 5 Rinse out the water tank with clear, fresh water.
- 6 Remove the ground coffee drawer, clean under running water and dry it thoroughly.
- 7 Wipe out the inside of the appliance (drip tray holder and ground coffee drawer) and the collecting tray and dry them.
- 8 Insert the dry parts, such as the ground coffee drawer.

Caution!

Not all of the appliance components can be cleaned in the dishwasher.

Not dishwasher-safe:



Shelf
Accessory drawer
Water tank with cover
Beverage dispenser cover
Metal connecting element
Bean container with lid
Ground coffee drawer
Protective cover for brewing unit
Brewing unit
Milk container

Dishwasher-safe:



Collecting tray
Drip tray
Drip tray cover
max. 60°C Coffee residue container
Milk hoses
Milk tube
Individual parts of the beverage dispenser
Measuring spoon
Individual parts of the milk container lid
Shelf for the milk container

Cleaning the milk system

The milk system is automatically cleaned with a short jet of steam directly after preparing a milk drink.

Important: Clean the milk system manually on a weekly basis, or more frequently if required.

⚠ Warning – Risk of burns!

The beverage dispenser gets very hot. After use, let it cool down first before touching it.

Cleaning the milk system automatically

- 1 Turn the function selector to **S**.
- 2 Use the rotary selector to select "Clean milk system".
- 3 Touch the ✓ symbol.
The cleaning programme starts. The information in the display guides you through the programme.
- 4 Open the door.
- 5 Remove the milk tube from the milk container and wipe it down. Insert the end of the milk tube into the hole in the coffee residue container.

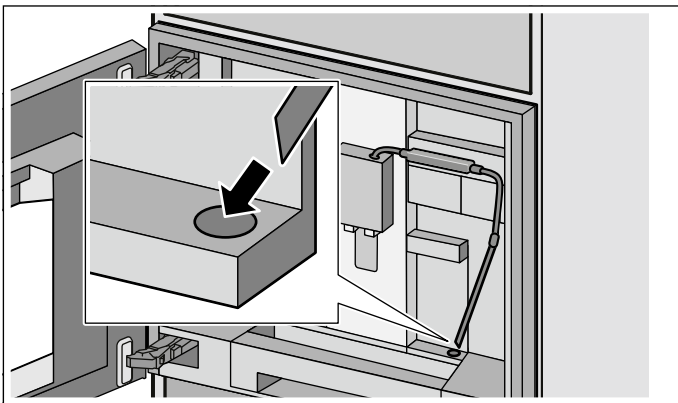

- 6 Close the door.
- 7 Place a container with a capacity of 0.5 l under the beverage dispenser.
- 8 Touch the ▶ symbol.
The programme runs for approx. 1 minute. Then empty the container.
- 9 Touch the ✓ symbol.

The programme has finished.

Cleaning the milk system manually

Take the milk system apart to clean it:

- 1 Push the beverage dispenser down completely and pull the cover forwards to remove.

- 2 Press the snap lever to the left of the beverage dispenser downwards and pull the beverage dispenser straight forwards.

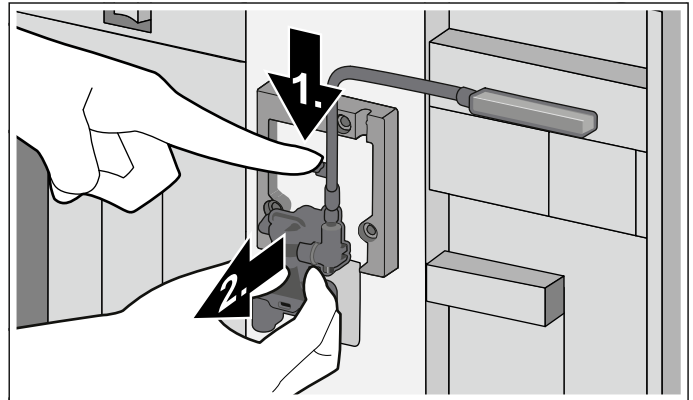

- 3 Detach the milk hose and dismantle the top and bottom sections of the beverage dispenser.

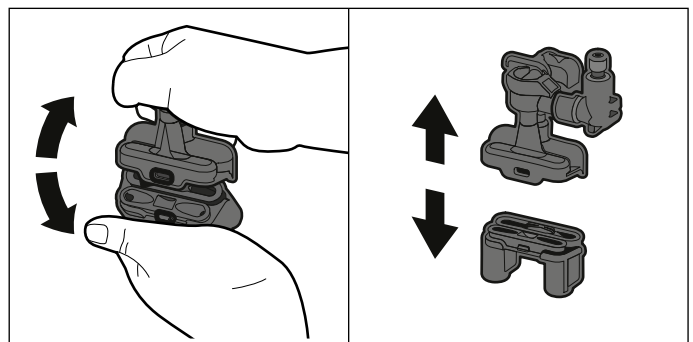

- 4 Separate the milk hoses, connecting element and milk tube.

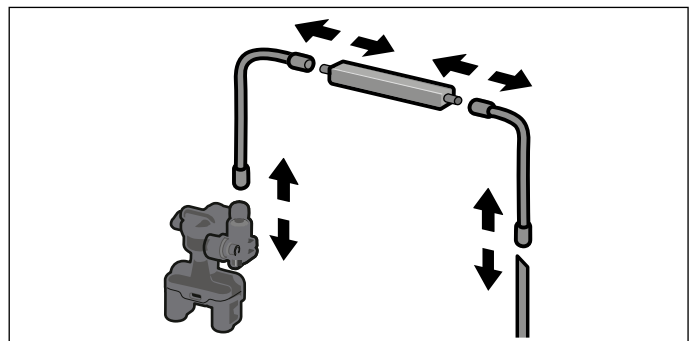

- 5 Clean the individual parts with a detergent solution and a soft cloth.
- 6 Rinse all parts with clean water and dry.
- 7 Put the individual parts back together again (also see quick reference guide).

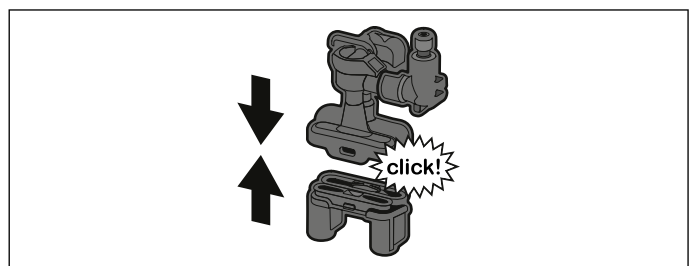

- 8 Firmly attach the beverage dispenser straight from the front onto the three connections.
- 9 Replace the cover.

Cleaning the milk container

For reasons of hygiene the milk container must be cleaned regularly. Only the individual parts of the lid are dishwasher-safe. Clean the stainless steel milk container by hand using a mild cleaning agent.

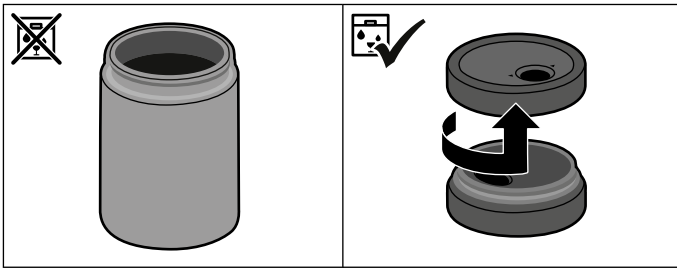

Cleaning the brewing unit

(Also see the quick reference guide)

Notes

- Regularly clean the brewing unit by hand in addition to the automatic cleaning programme.
- Do not use washing-up liquid or other cleaning agents to clean the brewing unit and do not put the brewing unit in the dishwasher.

- 1 Turn the function selector to **0**.
- 2 Open the door.
- 3 Switch off the appliance using the main switch.
- 4 Remove the protective cover of the brewing unit.
- 5 Remove the coffee residue container.
- 6 Slide the red latch on the brewing unit all the way to the left to .
- 7 Press the eject lever right down. The brewing unit will be released.
- 8 Take hold of the brewing unit by the recessed grips and carefully remove it.
- 9 Clean the brewing unit thoroughly under running water.

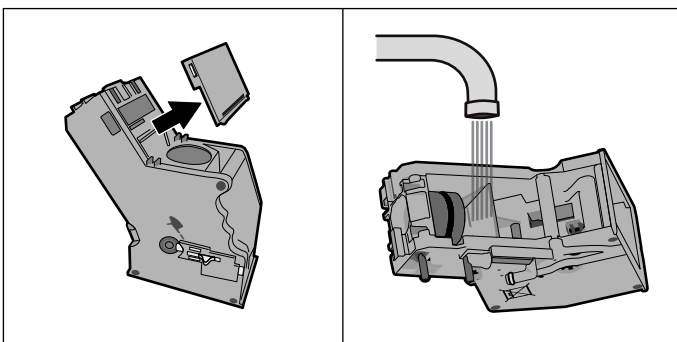

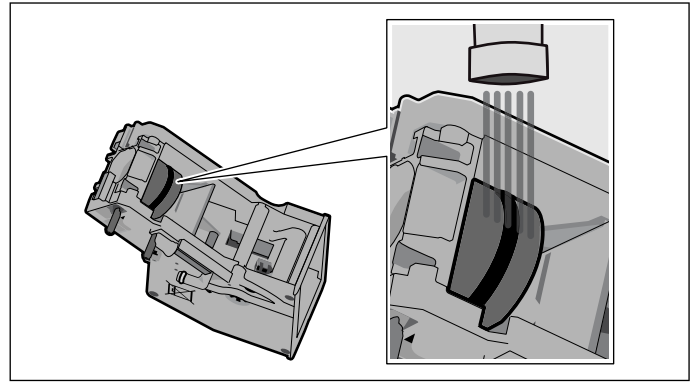

- 10 Remove the cover and clean the filter under running water.

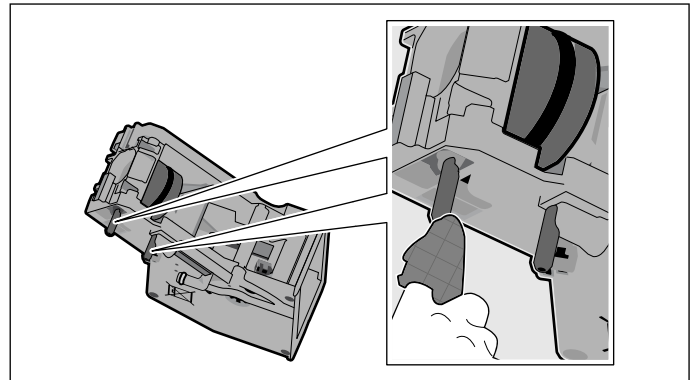

- 11 Thoroughly clean the connecting taps on the brewing unit.



- 12 Clean the interior of the appliance thoroughly, taking care to remove any coffee residues.
- 13 Allow the brewing unit and the interior of the appliance to dry.
- 14 Refit the cover.
- 15 Push the brewing unit all the way into the appliance, pressing on the middle until it audibly clicks into place.
Important: The red latch must be right over to the left to  before inserting.
- 16 Press the eject lever all the way up and push the red latch right over to the right to .
- 17 Insert the coffee residue container.
- 18 Replace the protective cover.
- 19 Close the door.

Service programmes

(Also see the quick reference guide)

Every so often – the exact frequency depends on usage and water hardness – one of the following messages will appear in the display in place of the coffee selection:

- Please change water filter
- Please clean
- Please descale
- Please descale and clean

The **i**[®] warning symbol then lights up.

The water filter should be changed immediately at this point and the appliance cleaned or descaled using the appropriate programme. Otherwise the appliance may be damaged.

The service programmes can also be started at any time without any prompt from the display. Set the function selector to **S** and select and run the desired programme.

Notes

- **Caution!** Do not drink or come into contact with cleaning or descaling materials. Keep cleaning materials and descaling tablets out of the reach of children. They may be toxic.
- **Important:** If the appliance is not descaled in good time, the message "Appliance locked Descaling required urgently" will appear. Immediately perform the descaling process in accordance with the instructions. If the appliance is locked, it can only be operated again once descaling has been carried out.
- **Caution!** With each of the service programmes, use descaling and cleaning agents as described in the instructions and observe the (relevant) safety information.
- Do not drink the liquids.
- Never use vinegar, vinegar-based products, citric acid or citric acid-based products for descaling.
- When cleaning and descaling, only use the tablets intended for such purpose. They have been specially developed for this appliance, and new stocks can be ordered through the after-sales service.
→ "Accessories" on page 39
- Never insert descaling tablets or other products into the grounds compartment.
- Never interrupt the service programme.
- Prior to starting a service programme, remove, clean and reinsert the brewing unit. Rinse the milk system.
- At the end of a service programme, wipe down the appliance using a soft, damp cloth to immediately remove any descaler residue. This residue may cause corrosion.

- New sponge cloths may contain salts. Salts can cause rust film on stainless steel, so cloths must always be washed out thoroughly before use.
- If a service programme is interrupted, e.g. by a power failure, proceed as follows:
 - 1 Rinse out the water tank.
 - 2 Pour in fresh, still water up to the "**max**" mark and confirm.
The programme starts and rinses the appliance. Duration approx. 2 minutes.
 - 3 Empty, clean and reinsert the drip tray.
- **Caution!** Do not drink the descale solution.

Cleaning

Duration: approx. 5 minutes

Prior to starting the service programme, clean the brewing unit. → "Cleaning the brewing unit" on page 55

- 1 Rotate the function selector to **S**.
- 2 Select "Cleaning programme" using the rotary selector.
- 3 Touch the ✓ symbol.
The cleaning programme starts. The information in the display guides you through the programme.
- 4 Empty and reinsert the drip tray and the coffee residue container.
- 5 Place a cleaning tablet in the ground coffee drawer and close the drawer again.
- 6 Close the door.
- 7 Place a container with a capacity of 0.5 l under the beverage dispenser.
- 8 Touch the ► symbol.
The programme will run for approx. 5 minutes.
- 9 Empty and reinsert the drip tray.
- 10 Touch the ✓ symbol.

The cleaning programme has now ended.

Descaling

Duration: approx. 21 minutes

- 1 Turn the function selector to **S**.
- 2 Select "Descaling programme" using the rotary selector.
- 3 Touch the ✓ symbol.
The descaling programme starts. The notes in the display guide you through the programme.
- 4 Empty and replace the drip tray and the coffee dregs container.
- 5 Remove the water filter (if there is one) and touch the ✓ symbol.
- 6 Pour lukewarm water into the empty water tank up to the "calc" mark (0.5 l) and then dissolve a descaling tablet in it.
- 7 Remove the milk tube from the milk container and wipe it down. Insert the end of the milk tube into the hole in the coffee residue container.

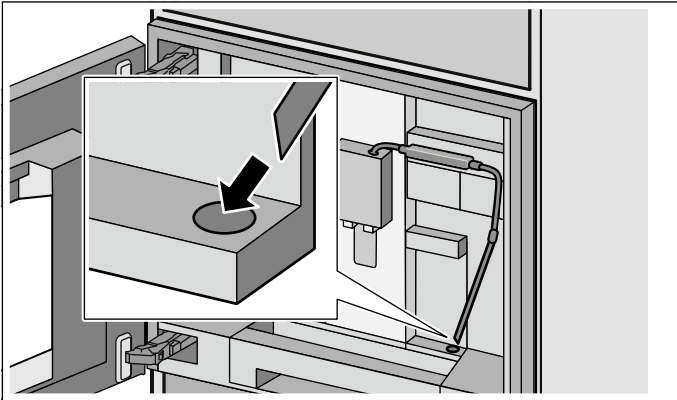

- 8 Close the door.
- 9 Place a container with a capacity of 0.5 l under the beverage dispenser.
- 10 Touch the ► symbol.
The programme will run for approx. 19 minutes.
Note: If there is too little descaling solution in the water tank, the message "Fill water tank with water and descaler" appears. Pour lukewarm water into the empty water tank up to the "calc" mark (0.5 l) and then dissolve a descaling tablet in it. Press ✓ to confirm. The programme will continue.
- 11 When prompted by the display, rinse the water tank and then fill it with fresh water up to the "max" mark. If a filter is used, reinsert it now.
- 12 Touch the ► symbol.
The programme will run for approx. 2 minutes and rinse the appliance.
- 13 Empty and replace the drip tray.
- 14 Touch the ✓ symbol.
The programme has finished.
- 15 Touch the ✓ symbol.
The appliance is ready to use.

Cleaning and descaling

Duration: approx. 26 minutes

The cleaning and descaling programme combines the individual cleaning and descaling functions. If the two programmes are both due at around the same time, the fully automatic espresso machine automatically suggests this service programme.

Prior to starting the service programme, clean the brewing unit. → "Cleaning the brewing unit" on page 55

- 1 Turn the function selector to **S**.
- 2 Select "Cleaning and descaling programme" using the rotary selector.
- 3 Touch the ✓ symbol.
The cleaning and descaling programme starts. The notes on the display guide you through the programme.
- 4 Empty and replace the drip tray and the coffee dregs container.
- 5 Place a cleaning tablet in the ground coffee drawer and close the drawer again.
- 6 Remove the water filter (if there is one) and touch the ✓ symbol.
- 7 Pour lukewarm water into the empty water tank up to the "calc" mark (0.5 l) and then dissolve a descaling tablet in it.
- 8 Remove the milk tube from the milk container and wipe it down. Insert the end of the milk tube into the hole in the coffee residue container.

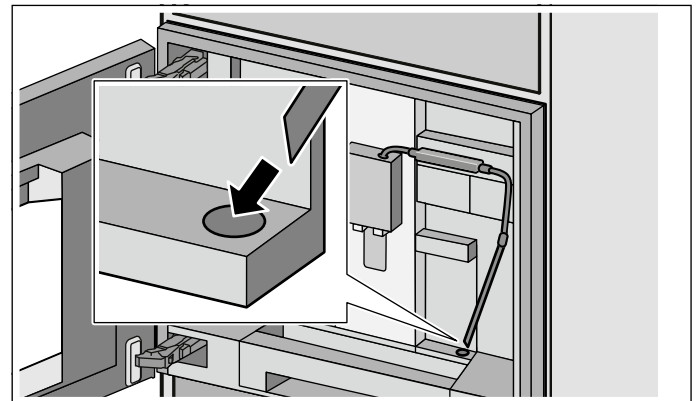

- 9 Close the door.
- 10 Place a container with a capacity of 0.5 l under the beverage dispenser.
- 11 Touch the ► symbol.
The programme will run for approx. 19 minutes.
Note: If there is too little descaling solution in the water tank, the message "Fill water tank with water and descaler" appears. Pour lukewarm water into the empty water tank up to the "calc" mark (0.5 l) and then dissolve a descaling tablet in it. Press ✓ to confirm. The programme will continue.

12 When prompted by the display, rinse the water tank and then fill it with fresh water up to the "max" mark. If a filter is used, reinsert it now.

13 Touch the ► symbol.
The programme will run for approx. 7 minutes and rinse the appliance.

14 Empty and replace the drip tray.

15 Touch the ✓ symbol.

The programme has finished.

16 Touch the ✓ symbol.
The appliance is ready to use.

Emptying programme

The emptying programme is a service programme which is used to remove coffee bean residue and to prevent damage caused by frost during transportation and storage. The appliance must be ready for use.

- 1** Rotate the function selector to **S**.
- 2** Select "Emptying programme" with the rotary selector.
- 3** Touch the ✓ symbol.
- 4** Empty the bean container and reinsert it.
- 5** If present, remove the milk container and close the door.
- 6** Close the door.
The emptying programme runs for approx. 2 minutes.
- 7** Empty and reinsert the water tank.
- 8** Close the door.
The emptying programme runs for approx. 2 minutes.
- 9** Remove the brewing unit and clean it thoroughly.
- 10** Touch the ✓ symbol.
- 11** Clean the drip tray, coffee residue container, milk system and milk hose set thoroughly and then reinsert them.
- 12** Close the door.

The emptying programme has finished.

Simple troubleshooting

Problem	Cause	Remedial action
The personally selected capacity is not reached. Coffee dispensing slows to a trickle or stops completely.	Grinding level is too fine. The ground coffee is too fine.	Adjust the grinding level to a coarser setting. Use coarser ground coffee.
	Heavy build-up of limescale in the appliance.	Descale the appliance as described in the instructions. → "Service programmes" on page 56
	The brewing unit is soiled.	Clean the brewing unit. → "Cleaning the brewing unit" on page 55
The hot water is milky or tastes of milk or coffee.	The milk hose has not been removed.	Remove the milk hose from the milk container.
	Milk or coffee residue in the beverage dispenser.	Clean the beverage dispenser.
The coffee has no crema.	Unsuitable type of coffee.	Use a type of coffee with a higher proportion of robusta beans.
	The beans are no longer freshly roasted.	Use fresh beans.
	The grinding level was not suitable for the coffee beans.	Set a finer grinding level.
The coffee is too "acidic".	The grinding level is too coarse. The ground coffee is too coarse.	Adjust the grinding level to a finer setting. Use finer ground coffee.
	Unsuitable type of coffee.	Change the type of coffee.
The coffee is too bitter.	Grinding level is too fine. The ground coffee is too fine.	Adjust the grinding level to a coarser setting. Use coarser ground coffee.
	Unsuitable type of coffee.	Change the type of coffee.
The coffee tastes burnt.	The brewing temperature is too high.	Reduce the temperature. → "Preparing beverages" on page 44
	Grinding level is too fine. Ground coffee is too fine.	Adjust the grinding level to a coarser setting. Use coarser ground coffee.
	Unsuitable type of coffee.	Change the type of coffee.
The coffee is too weak.	Coffee strength selected is too weak.	Use stronger coffee. → "Preparing beverages" on page 44
	Ground coffee drawer blocked with ground coffee.	Remove the ground coffee drawer, clean and dry it thoroughly.
The ground coffee gets stuck in the ground coffee drawer.	The ground coffee sticks together.	Do not compact the ground coffee in the ground coffee drawer.
	The ground coffee drawer is damp.	Remove the ground coffee drawer, clean and dry it thoroughly.
The water filter does not stay in position in the water tank.	The water filter is not fitted correctly.	Firmly press the water filter straight down into the tank connection.
The bean container sticks when inserted.	There are beans in the housing.	Remove beans.
The coffee grounds are not compact and are too wet.	The grinding level is set too fine or coarse, or not enough ground coffee has been used.	Set a coarser or finer grinding level or use 2 level measuring spoons of ground coffee.
The grinding level adjustment is stiff.	Too many beans in the grinding unit.	Dispense a beverage made from coffee beans. Only make any subsequent changes to the grinding level in small steps.
The brewing unit cannot be inserted.	Brewing unit in the wrong position.	Insert the brewing unit as described in the instructions. → "Cleaning the brewing unit" on page 55
	Brewing unit is locked.	Unlock brewing unit. → "Cleaning the brewing unit" on page 55

Problem	Cause	Remedial action
The protective cover of the brewing unit cannot be properly attached.	Brewing unit is not locked.	Lock the brewing unit. → "Cleaning the brewing unit" on page 55
There is water under the drip tray.	This is condensation.	Do not insert the drip tray without the cover.
Display screen "Milk container connected?" despite connected milk container.	Container is outside the range of the sensor.	Position the container at the right-hand edge.
	Material, e.g. milk carton, is not recognised.	Confirm the display query with "Yes" or use the supplied milk container.
No milk dispensed despite filled milk container.	The milk tube is not inserted deep enough in the milk container.	Insert the milk tube down to the bottom of the milk container.
The milk container is empty, but no message is displayed.	The shelf (scales) for the milk container is soiled.	Remove shelf. Clean the shelf and the area underneath thoroughly.
Display screen "High or low voltage".	Voltage is too high or too low.	Contact electricity or grid provider. Have the power supply checked by an expert.
Display screen "Let appliance cool down".	Appliance is too hot.	Switch off appliance for 30 minutes.
Display screen "Error: E0510".	The appliance has encountered an error.	Proceed according to the display screen.
Display screen shows "Fill bean container". The appliance does not grind the beans despite filled bean container.	Beans do not drop into the grinding unit (beans that are too oily may stick to the bean container).	Gently tap the bean container. Possibly change the type of coffee. When the bean container is empty, wipe it with a dry cloth.
Display screen shows "Remove brewing unit and clean by hand".	Brewing unit is soiled.	Clean the brewing unit.
	Too much ground coffee in the brewing unit.	Clean the brewing unit. Add no more than two level measuring spoons of ground coffee.
	The brewing unit mechanism is stiff.	Clean the brewing unit. → "Cleaning the brewing unit" on page 55
Display screen "Refill with still water or remove filter".	Water tank wrongly inserted.	Insert water tank correctly.
	Carbonated water in the water tank.	Fill the water tank with fresh tap water.
	Float is stuck in the water tank.	Remove the tank and clean thoroughly.
	New water filter not rinsed according to instructions, or water filter spent or defective.	Rinse the water filter according to the instructions and then switch on, or use a new water filter.
	Air in the water filter.	Immerse the water filter in water until no more air bubbles escape. Then insert the filter again.
Display screen "Clean trays and replace" despite being empty.	Drip tray is soiled and wet.	Clean and dry the drip tray thoroughly.
	Emptying is not detected when the appliance is off.	When the appliance is switched on, remove and reinsert the drip tray.
Display screen "Insert trays" despite being inserted.	Inside of appliance (tray holder) soiled.	Clean the inside.
	The coffee residue container was not fully inserted.	Push the coffee residue container all the way in.
Water dripped onto the inner floor of the appliance when the drip tray was removed.	Drip tray was removed too soon.	Wait a few seconds after the last drink was dispensed before removing the drip tray.
Display screen "Switch off appliance"	Appliance is too warm.	Allow the appliance to cool down.
	Brewing unit is soiled.	Clean the brewing unit.
Display screen "Contact after-sales service".	The appliance has encountered an error.	Please contact the hotline.
If you are unable to solve the problem, always call the hotline.		

Country of origin: Slovenia

Exclusive distributor:

BSH Home Appliances (China) Co., Ltd. Zhongnan
International Tower Building 20 and 21, No. 129
Zhongshan Road, Nanjing

Applicable Standards:

GB 4706.1-2005

Safety of Household and Similar Electrical Appliances
Part 1: General Requirements

GB 4706.19-2008

Safety of Household and Similar Electrical Appliances –
Particular Requirements for Liquid Heaters

GB 4706.30-2008

Safety of Household and Similar Electrical Appliances –
Particular Requirements for Kitchen Machines

Technical data

Electrical connection (voltage – frequency)	220–240 V ~, 50 / 60 Hz
Power rating	1600 W
Maximum static pump pressure	19 bar
Maximum capacity of the water tank (without filter)	2,4 l
Maximum capacity of the coffee bean container	500 g
Length of the power cable	1,7 m
Dimensions (H x W x D)	455 x 590 x 444 mm
Weight, empty	21–22 kg
Type of grinder	Ceramic

Gaggenau Hausgeräte GmbH
Carl-Wery-Straße 34
81739 München
GERMANY
www.gaggenau.com

8001106182 (980118)
en, zh



GAGGENAU