

Gaggenau

en Operating instructions

RB 491

RY 491

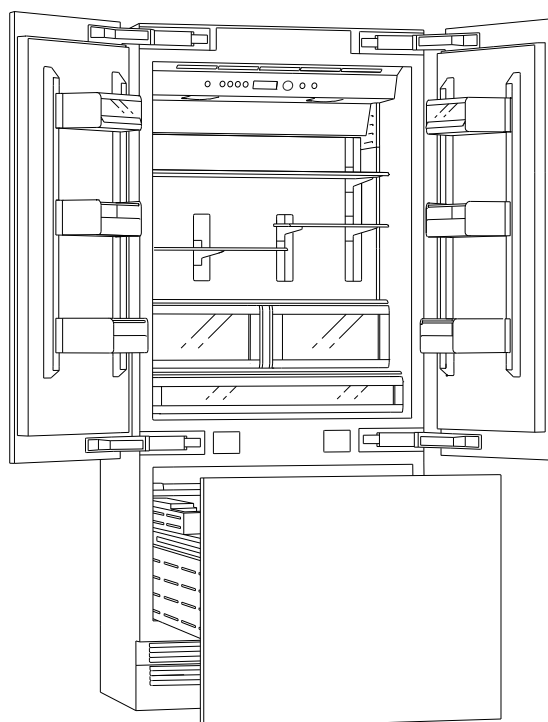

Table of Contents

Congratulations	5
------------------------------	----------

Safety and warning information	5
---	----------

Before you switch ON the appliance	5
--	---

Technical safety	5
------------------------	---

Important information when using the appliance	6
--	---

Children in the household	6
---------------------------------	---

General regulations	6
---------------------------	---

Information concerning disposal	7
--	----------

Disposal of packaging	7
-----------------------------	---

Disposal of your old appliance	7
--------------------------------------	---

Your new appliance	8
---------------------------------	----------

2 door model	8
--------------------	---

3 door model	9
--------------------	---

Fascia	10
---------------------	-----------

Installation instructions	11
--	-----------

Installation location	11
-----------------------------	----

Observing ambient temperature and ventilation	11
---	----

Fixing	11
--------------	----

Subsurface	11
------------------	----

Connecting the appliance	11
---------------------------------------	-----------

Water connection	12
-------------------------------	-----------

Electrical connection	12
------------------------------------	-----------

Factory settings	12
-------------------------------	-----------

Switching on the appliance	12
---	-----------

Selecting the temperature	13
--	-----------

Refrigerator compartment	13
--------------------------------	----

Freezer compartment	13
---------------------------	----

Set the language	13
-------------------------------	-----------

Motorised compartment	14
------------------------------------	-----------

“cool-fresh” drawer	14
----------------------------------	-----------

Refrigerator compartment with two doors	14
--	-----------

Variable interior design	15
---------------------------------------	-----------

Refrigerator compartment	15
--------------------------------	----

Freezer compartment	16
---------------------------	----

Fast cooling	16
---------------------------	-----------

Fast freezing	17
----------------------------	-----------

Setup mode	17
-------------------------	-----------

Menus in the setup mode	18
-------------------------------	----

Temperature unit	18
------------------------	----

Language setting	18
------------------------	----

Energy saving mode	19
--------------------------	----

Door rail heater	19
------------------------	----

Alarm function	19
-----------------------------	-----------

Switching off the warning signal	19
--	----

Door alarm	19
------------------	----

Holiday mode	20
---------------------------	-----------

Rest mode	20
------------------------	-----------

Storing food in the refrigerator compartment	21
---	-----------

Pay attention when arranging food	21
---	----

When buying food, please note	21
-------------------------------------	----

Freezing and storing food	21
--	-----------

Purchasing frozen food	21
------------------------------	----

Freezing deep-frozen food	21
---------------------------------	----

Packing food correctly	21
------------------------------	----

Shelf life of frozen food	21
---------------------------------	----

Thawing frozen food	22
---------------------------	----

Usable capacity	22
------------------------------	-----------

Maximum freezing capacity	22
--	-----------

Ice maker	22
Switch on the ice maker	22
Switch the ice maker off	22
Removing and cleaning the ice cube container	23
Tips for saving energy	23
Operating noises	23
Normal operating noises	23
Noises which can be easily rectified	23
Thawing the appliance	23
Switching off and disconnecting the appliance.....	23
Switching off the appliance	23
Disconnecting the appliance	23
Cleaning the appliance.....	24
Odours	24
Warning messages via the display	24
Door alarm.....	24
Sensor failure.....	24
Low voltage	24

Water filter	25
Eliminating minor faults yourself	26
Appliance	26
Ice maker	26
Change the light bulbs.....	28
Upper halogen lamps in the refrigerator compartment	28
Side halogen lamps.....	28
Changing activated carbon air filter.....	29
Customer service	29

Congratulations

With the purchase of your new fridge-freezer you have opted for a modern, high-quality domestic appliance.

The outstanding feature of your new appliance is its low power consumption.

Each appliance which leaves our factory is inspected thoroughly to ensure that it functions properly and is in perfect condition.

If you have any questions – particularly concerning installation and connection of the appliance – please do not hesitate to contact our customer service.

Further information and a selection of our products can be found on our home page.

Safety and warning information

Before you switch ON the appliance

Please read the operating and installation instructions carefully. They contain important information on how to install, use and maintain the appliance.

Retain all documents for subsequent use or for the next owner.

Technical safety

Warning

This appliance contains a small quantity of environmentally friendly but flammable R600a refrigerant. Ensure that the tubing of the refrigerant circuit is not damaged during transportation and installation. Leaking refrigerant may cause eye injuries or ignite.

If damage has occurred

- keep naked flames and/or ignition sources away from the appliance,
- pull out the mains plug,
- thoroughly ventilate the room for several minutes,
- notify customer service.

The more refrigerant an appliance contains, the larger the room must be. Leaking refrigerant can form a flammable gas-air mixture in rooms which are too small.

The room must be at least 1 m³ per 8 g of refrigerant. The amount of refrigerant in your appliance is indicated on the rating plate inside the appliance.

Important information when using the appliance

- Never use electrical appliances inside the appliance (e.g. heater, etc.).
Risk of explosion!
- Never use a steam cleaner to defrost or clean the appliance! The steam may penetrate electrical parts and cause a short-circuit.
Risk of electric shock!
- Do not store products which contain flammable propellants (e.g. spray cans) or explosive substances in the appliance.
Risk of explosion!
- Do not stand or support yourself on the base, drawers or doors, etc.
- For cleaning and exchanging the bulb, pull the mains plug out or switch off the fuse. Do not pull out the mains plug by tugging the cable.
- **Caution:** When the appliance is switched off using the temperature setting (Display: $\square FF$), the supply of current is not disrupted.
- Bottles which contain a high percentage of alcohol must be sealed and stored in an upright position.
- Keep plastic parts and the door seal free of oil and grease. Otherwise, parts and door seal will become porous.
- Never cover or block the ventilation openings for the appliance.
- People who have limited physical, sensory or mental abilities or inadequate knowledge must not use this appliance unless they are supervised or given meticulous instructions.
- Do not store bottled or canned drinks (especially carbonated drinks) in the freezer compartment. Bottles and cans may explode!
- Never put frozen food straight from the freezer compartment into your mouth.
Risk of low-temperature burns!
- Avoid prolonged touching of frozen food, ice or the evaporator pipes, etc.
Risk of low-temperature burns!

- Do not use any mechanical device or other aid to accelerate the defrosting process.
- Do not scrape off hoarfrost or stuck frozen food with a knife or pointed object. You could damage the refrigerant tubing. Leaking refrigerant may ignite or cause eye injuries.
- Only customer service may change the power cable and carry out any other repairs. Improper installations and repairs may put the user at considerable risk.
- Only original parts supplied by the manufacturer may be used. The manufacturer guarantees that only these parts satisfy the safety requirements.

Children in the household

- Do not allow children to play with the appliance!
- If the appliance features a lock, keep the key out of the reach of children!

General regulations

The appliance is suitable

- for refrigerating food,
- for freezing food,
- for making ice.

This appliance is intended for use in the home and the home environment.

The appliance is suppressed according to EU Directive 2004/108/EC.

The refrigeration circuit has been checked for leaks.

This product complies with the relevant safety regulations for electrical appliances (EN 60335/2/24).

Information concerning disposal

Disposal of packaging

The packaging protects your appliance from damage during transit. All utilised materials are environmentally safe and recyclable. Please help us by disposing the packaging in an environmentally friendly manner.

Please ask your dealer or inquire at your local authority about current means of disposal.

Warning

Keep children away from packaging and its parts.
Danger of suffocation from collapsible boxes and foil!

Disposal of your old appliance

Old appliances are not worthless rubbish! Valuable raw materials can be reclaimed by recycling old appliances.



This appliance has been identified in accordance with the European directive 2002/96/EG on Waste Electrical and Electronic Equipment – WEEE. The directive specifies the framework for an EU-wide valid return and re-use of old appliances.

Warning

Redundant appliances:

- Pull out the mains plug.
- Cut off the power cord and discard with the mains plug.

Refrigerators contain refrigerant and gases in the insulation. Refrigerant and gases must be disposed of professionally. Ensure that tubing of the refrigerant circuit is not damaged prior to proper disposal.

Your new appliance

2-door model

These operating instructions refer to several models. Illustrations can differ.

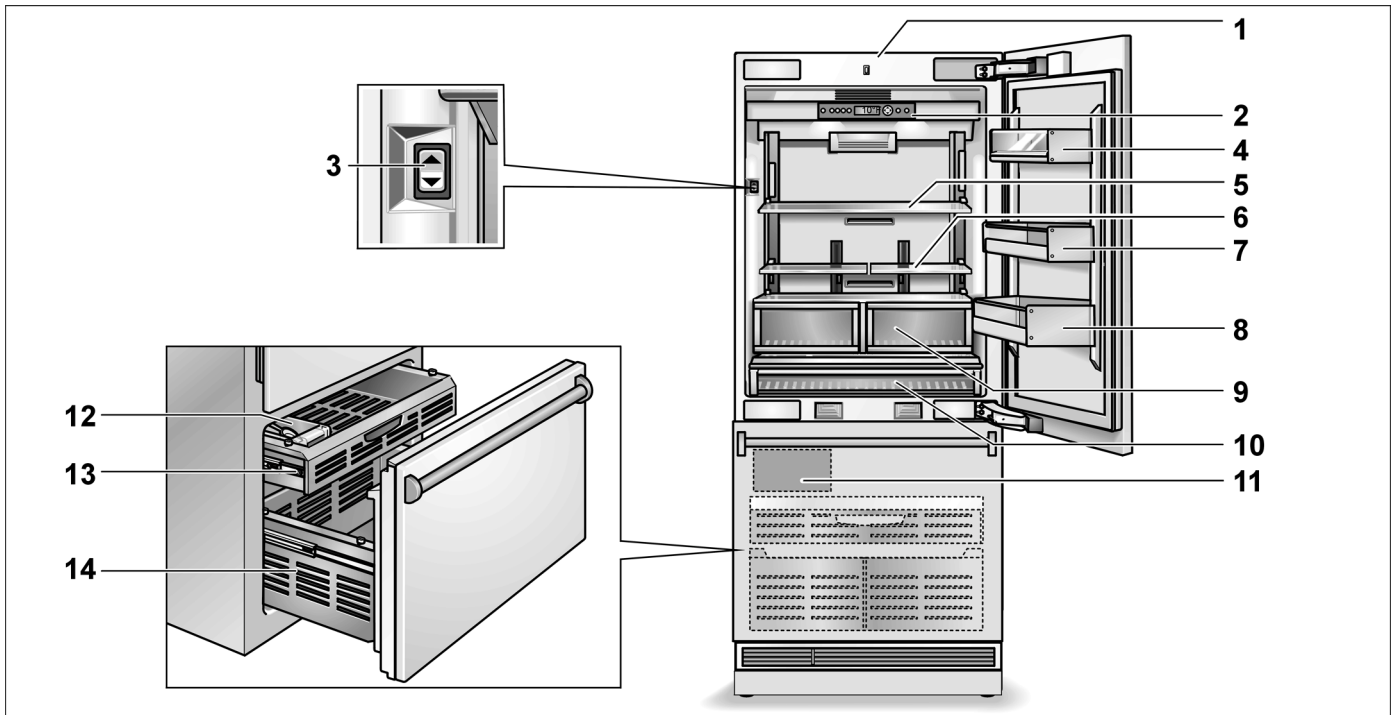

Refrigerator compartment (1-door)

- 1 Light switch
- 2 Fascia
- 3 Butter and cheese compartment
- 4 Motorised compartment button
- 5 Motorised compartment
- 6 Glass shelves
- 7 Door storage compartment
- 8 Bottle storage compartment
- 9 Fruit and vegetable drawer
- 10 "cool-fresh" drawer

Freezer compartment

- 11 Ice maker *
- 12 Ice cube container
- 13 Drawer
- 14 Door drawer

* not visible

3-door model

These operating instructions refer to several models. Illustrations can differ.

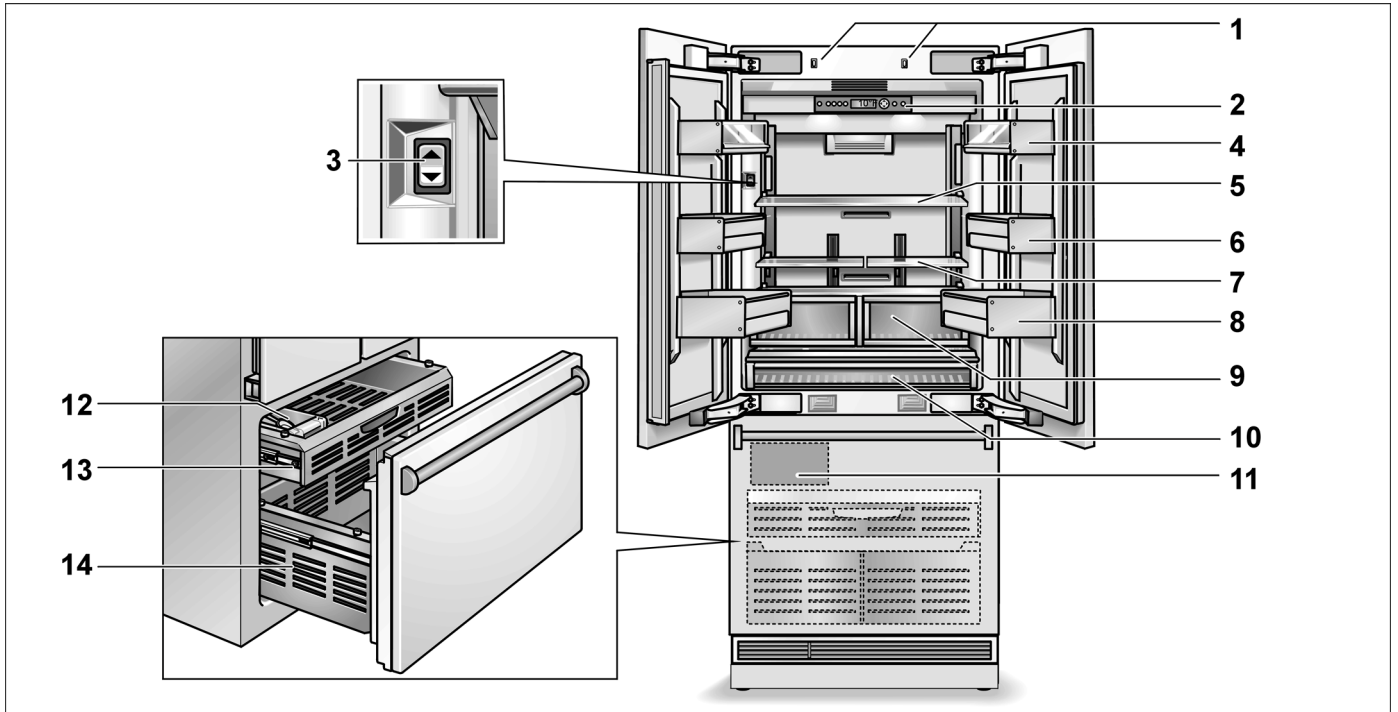

Refrigerator compartment (2-door)

- 1 Light switch
- 2 Fascia
- 3 Butter and cheese compartment
- 4 Motorised compartment button
- 5 Motorised compartment
- 6 Door storage compartment
- 7 Glass shelves
- 8 Bottle storage compartment
- 9 Fruit and vegetable drawer
- 10 "cool-fresh" drawer

Freezer compartment

- 11 Ice maker *
- 12 Ice cube container
- 13 Drawer
- 14 Door drawer

* not visible

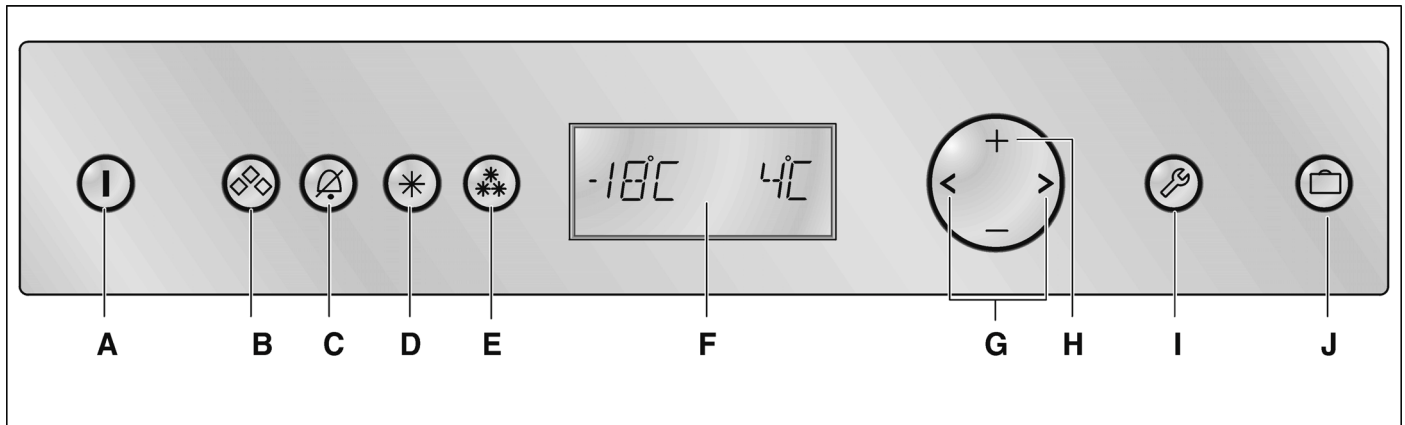

A On/off button

Serves to switch the appliance on and off.

B Ice maker button

Serves to switch the ice maker on and off. See section "Ice maker".

C Alarm button

Used to switch off the warning signal. See section "Switching off the warning signal".

D Fast cooling button

See section "Fast cooling".

E Fast freezing button

See section "Fast freezing".

F Display panel

The temperatures in the refrigerator compartment and in the freezer compartment are shown in the display panel. Activated special functions are shown using symbols, e.g. fast freezing – **SUPER** .

The menus and setting options which are available are represented on the fascia in the setup mode. See section "Setup mode".

G Selection buttons < >

The temperature setting is activated using the selection buttons < >. See section "Selecting the temperature".

For selecting a menu in the setup mode. See section "Setup mode".

H Setting buttons +/-

In the temperature setting mode, the temperature can be changed using the setting buttons +/- . See section "Selecting the temperature".

For setting the parameters available in the menu. See section "Setup mode".

I Press setup button

This button starts and ends the setup mode. If the setup mode is ended using the setup button , the changes which have been made are stored.







J Press Holiday button

For switching the energy saving holiday mode on and off. See section "Holiday mode".

Note

A sound can be heard every time a button is actuated if this function is activated (**ON**) in the sound menu during the setup mode.

Symbols in the display field

	Refrigerator compartment display
	Freezer compartment display
	Fast cooling or fast freezing is active, see "Fast cooling"/"Fast freezing".
	Holiday mode is activated, see "Holiday mode".
	For the setting options in the set up mode, see "Setup mode".
	A warning message is displayed, see "Warning messages via the display".
	Ice maker is switched on, see "Ice maker".

Installation instructions

Installation location

The appliance should be installed in a dry, well ventilated room.

The installation location should neither be exposed to direct sunlight nor near a heat source, e.g. a cooker, radiator, etc.

If installation near a heat source is unavoidable, use a suitable insulating plate or observe the following minimum distances to a heat source:

- 3 cm to electric or gas cookers.
- 30 cm to an oil-fired or solid-fuel cooker.

To ensure that the ice maker functions correctly, the appliance must be upright.

Observing ambient temperature and ventilation

Ambient temperature

The climate class can be found on the rating plate. It states the room temperature within which the appliance can be operated.

Climate class	Permitted ambient temperature
SN	+10 °C to 32 °C
N	+16 °C to 32 °C
ST	+16 °C to 38 °C
T	+16 °C to 43 °C

Ventilation

Never cover the ventilation openings in the base panel. The cooling motor otherwise has to increase its output, and this increases the electricity consumption.

Fixing

For secure installation, the appliance is screwed to neighbouring kitchen furniture and/or units.

It is very important therefore that all bordering furniture and/or units are fixed securely to the floor and/or walls. If making structural changes fix the appliance in place again corresponding to the installation instructions.

Subsurface

⚠ Caution

The appliance is very heavy.

The weight of the appliance when fully loaded is approx. 500 kg.

A load-bearing base is necessary because of the heavy weight of the fully laden appliance.

In case of doubt, consult an architect or structural engineer.

The floor of the installation location must not give way; if required, reinforce floor.

Connecting the appliance

⚠ Warning

Have a technician install and connect the appliance according to the enclosed installation instructions.

Do not remove the transportation protection devices from the shelves and storage compartments until the appliance has been installed.

Always connect the water before the power.

Apart from statutory national regulations, you should stick to the connection terms relating to the local electricity and water companies.

After installing the appliance, wait at least 1 hour until the appliance starts up. During transportation the oil in the compressor may have flowed into the refrigeration system.

Before switching on the appliance for the first time, clean the interior of the appliance (see chapter "Cleaning the appliance").

Water connection

Warning

Only connect the appliance to a drinking water supply!

The water may be connected only by a competent fitter according to the local regulations of the appropriate water supply company.

A cold water connection is necessary for operating the automatic ice maker. The water pressure must be between 0,2 MPa and 0,8 MPa (2,0 bar and 8,0 bar). The installation must correspond to the local plumbing regulations.

A separate shut-off valve should be installed in the cold-water inflow. The shut-off valve should not be located behind the appliance. It is recommended that you mount the shut-off valve directly next to the appliance or at another place which is easily accessible.

When installing the water connection, pay attention to the permissible installation area for the water mains.

For connection to the drinking water mains use only water pipes which are suitable for drinking water. Observe national regulations and the connection conditions of the local water supply companies.

The maximum outside diameter of the water mains (without connecting pieces) is 10 mm.

Electrical connection

The socket must be near the appliance and also freely accessible following installation of the appliance.

The appliance complies with the protection class I. Connect the appliance to 220–240 V/50 Hz alternating current via a correctly installed socket with protective conductor. The socket must be fused with a 10 A to 16 A fuse.

For appliances operated in non-European countries, check whether the stated voltage and current type on the rating plate match the values of your mains supply match the values of the mains supply. The rating plate is situated in the bottom left-hand side of the appliance.

Warning

Never connect the appliance to electronic energy saver plugs. Our appliances can be used with mains and sine-controlled inverters. Mains-controlled inverters are used for photovoltaic systems which are connected directly to the power supply system. Sine-controlled inverters must be used for isolated applications (e.g. on ships or in mountain lodges) which are not connected directly to the national grid.

Factory settings

The factory settings (language, temperature unit) can be changed in the setup mode.

Switching on the appliance

- Press the on/off button .

The appliance starts to cool down when switched on for the first time. When the door is opened, the interior light comes on.

Note

The preset temperatures (factory settings) are reached after several hours. Do not put any food in the appliance beforehand!

To change the set temperatures → see “Selecting the temperature”.

Selecting the temperature

To set the temperature:

- Activate the setup mode using the < or > buttons.

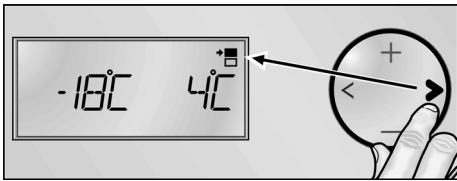

> for the refrigerator compartment

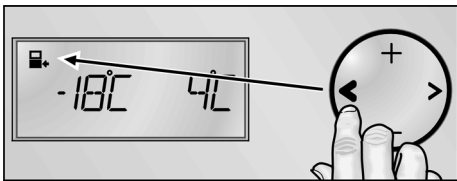

< for the freezer compartment

The corresponding symbol (◻+ / ◻-) is shown.

Refrigerator compartment

The temperature can be adjusted from +2 °C to +8 °C.
We recommend a setting of +4 °C.

Perishable food should not be stored warmer than +4 °C.

The temperature setting can be changed using the + (warmer) or - (cooler) setting buttons. The temperature can be set at 1 °C intervals.

To set the refrigerator compartment temperature:

- Activate the setup mode with the > button. Symbol ◻+ is shown.

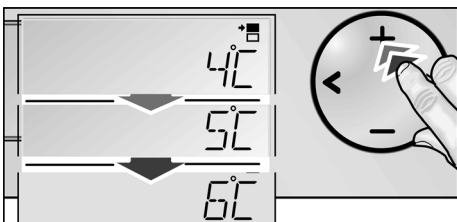

- Set the desired temperature using the + (warmer) or - (cooler) setting buttons.

Freezer compartment

The temperature can be set from -16 °C to -24 °C.
We recommend a setting of -18 °C.

The temperature setting can be changed using the + (warmer) or - (cooler) setting buttons. The temperature can be set at 1 °C intervals.

To set the freezer compartment temperature:

- Activate the setup mode with the < button. The ◻- symbol is displayed.

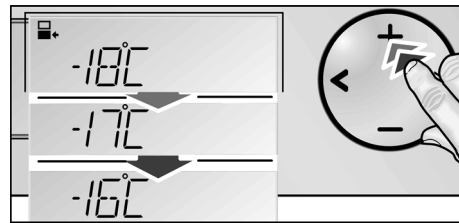

- Set the desired temperature using the + (warmer) or - (cooler) setting buttons.

Set the language

When the appliance is operated, all messages are displayed in fascia in English.

Alternatively, the display languages can be selected corresponding to the table in section "Menus in the setup mode".

In order to change the display language:

- Press setup button (Ⓢ).
- Press the selection button >, until *ENGLISH* is displayed.

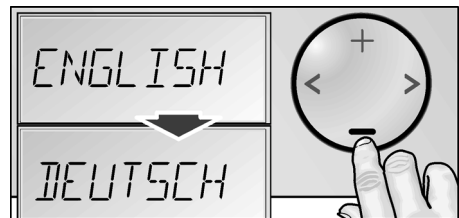

- Press the + or - setting button, until the desired language is displayed.
- Press the setup button (Ⓢ), in order to store the settings. The set temperature is displayed again in the fascia.

Motorised compartment

The appliance is equipped with a height-adjustable motorised compartment.

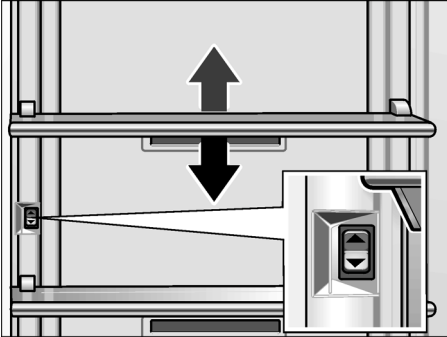

- When the toggle switch is set upwards:
The compartment moves upwards
- When the toggle switch is set downwards:
The compartment moves downwards

Note

Maximum motorised compartment load: 10 kg

The drive cuts out if overloaded in order to avoid damage.

“cool-fresh” drawer

The temperature in this compartment is kept at almost 0 °C. This provides optimum storage conditions for fresh food such as fish, meat and poultry.

The temperature in the “cool-fresh” drawer can be reduced slightly with the slide control.

We recommend the following controller position:

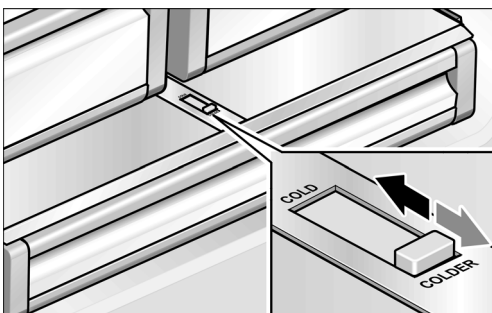

COLD: Meat, sausage and poultry

COLDER: Fish

Refrigerator compartment with two doors

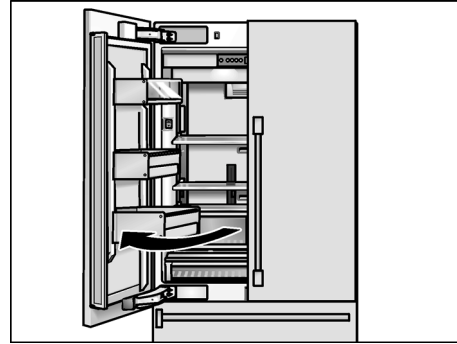

The left door of the refrigerator compartment can be opened without having to first open the right door.

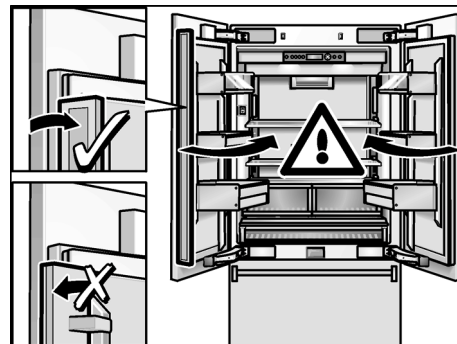

Caution when closing the door! The bar fitted to the left door has to be folded back when closing the door, otherwise damage can be done to the appliance or the furniture fronts.

A heating element is integrated into the bar in order to avoid condensation.

This can be switched on and off (see chapter Special functions, section “Door rail heater”).

Variable interior design

Refrigerator compartment

You can vary the shelves inside the appliance and the containers in the door to suit your requirements:

Shelves

The height of the glass shelves can be adjusted.

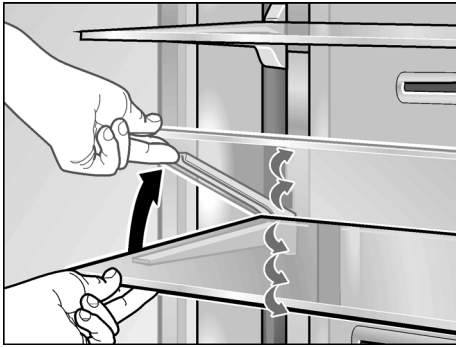

- Lift the compartment front and move it upwards or downwards into the guiding positions.
- Lower the compartment front to the desired height. The holders engage into the guiding positions.

Removing the compartments:

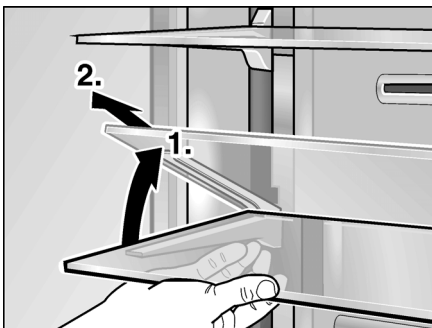

Lift the compartment front and move it into the guiding positions as far as the openings. Remove the compartment forwards.

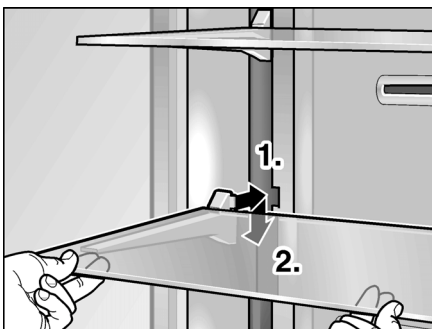

Place the compartment into the guiding positions openings and press downwards. Set the compartment to the desired height.

Door storage compartment

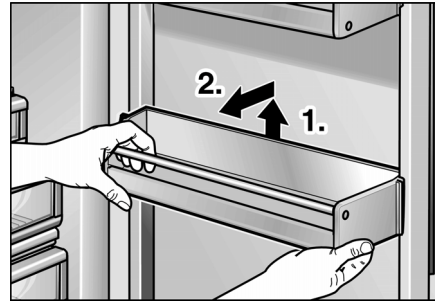

Lift the container and remove.

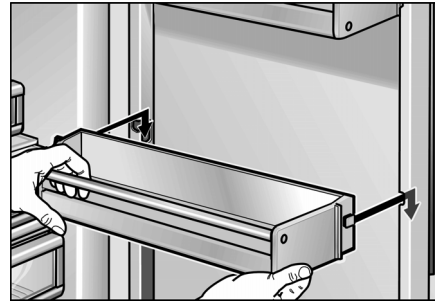

Place the containers at the desired heights and press downwards.

Drawers

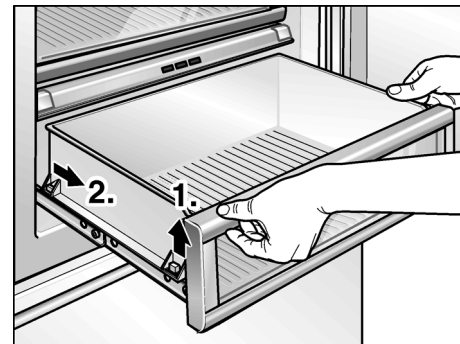

To take out, lift the drawers slightly and take out.

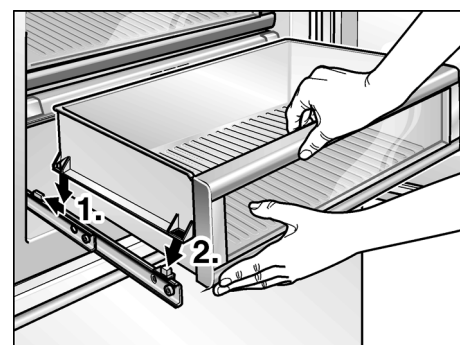

To place in, lift the front of the drawers slightly and place into the chest of drawers. Lower the drawer and slide it backwards.

Fast cooling

Freezer compartment

The drawers in the refrigerator compartment can be taken out for cleaning.

The upper drawer must first be removed before the door drawer can be taken out.

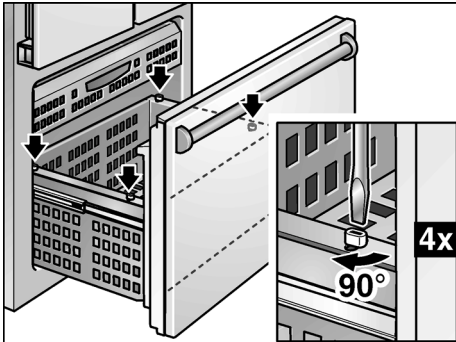

- Turn the fastenings on the pullout section by 90° using a screwdriver.

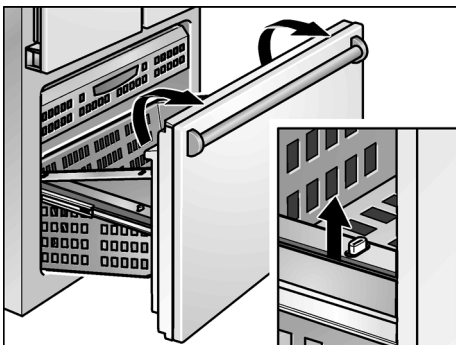

- To take out, lift the drawer slightly and take out.
- To place in, lift the front of the drawers slightly and insert in the pullout section. Lower the drawer and slide it backwards.
- Turn the fastenings on the pullout section by 90° using a screwdriver.

In the fast cooling mode, the refrigerated zone will be cooled for approx. 6 hours as cold as possible.

Switch the function on:

- To cool drinks quickly.
- Before placing large quantities of food in the refrigerator compartment.

This function is activated by pressing the fast cooling button .

In the display panel the **SUPER**  symbol appears below the fast cooling temperature.

Above the temperature, the compartment is shown for which the function has been activated.



“Fast cooling” function ends:

- by pressing the fast cooling button  again.

After approx. 6 hours, the appliance automatically switches back to the temperature set before fast cooling.

Fast freezing

The fast freezing function is ideal when storing larger amounts of food. It should be activated 4–6 hours before placing food in the freezer. 24 hours are necessary when using the maximum freezer capacity fully.

This function is activated by pressing the fast freezing button .

The **SUPER**  symbol appears in the fascia under fast freezing temperature.

Above the temperature, the compartment is shown for which the function has been activated.



Fast freezing function ends:

- by pressing the fast freezing button  again.

After 2 days the appliance automatically switches back to the temperature which was set before fast freezing.

Setup mode

There are menus for adapting the appliance to the individual user requirements. These adaptations are carried out in the setup mode.

To activate the setup mode:

- Press setup button .

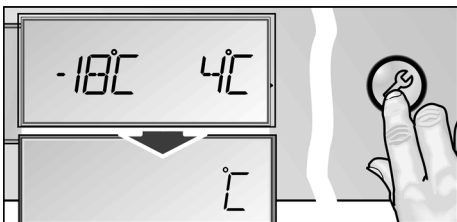

The first menu (temperature unit) is displayed in the fascia.

To switch to the next menu:

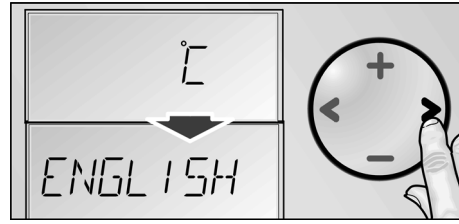

- Press the selection button < or >. The next menu is displayed and its current setting (mostly **ON** or **OFF**).

To make a selection within the setting options of a menu:

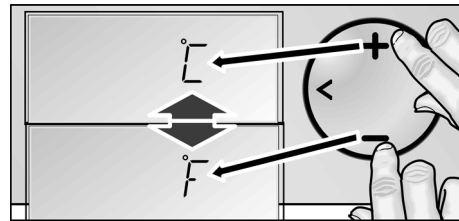

- Press the setting button + or -.

A changed setting is stored, if the next menu is selected using < or >.

To deactivate the setup mode:

- Press setup button . All of the changed settings are stored.

If no button is selected within 20 seconds, the setup mode ends automatically. All of the changed settings are stored. The set temperature is displayed again in the fascia.

Menus in the setup mode

Menu	Setting options	Displayed text
Temperature unit	°C (degrees Celsius) °F (degrees Fahrenheit)	°C °F
Language	German English French Danish Finnish Greek Dutch Italian Polish Portuguese Norwegian Russian Swedish Spanish Turkish Czech	DEUTSCH ENGLISH FRANCAIS DANSK SUOMI ELLINIKΑ NEBERL ITALIANO POLSKI PORTUG NORSK RUSSK SVENSKA ESPAÑOL TURKCE CESKY
Sound	On/ ON Off/ OFF	TONE
Energy saving mode (eco function)	On/ ON Off/ OFF	ECO MODE
Door rail heater	On/ ON Off/ OFF	DRY DOOR

Temperature unit

The temperature can be displayed in degrees Celsius (°C) or degrees Fahrenheit (°F).

- Press setup button .

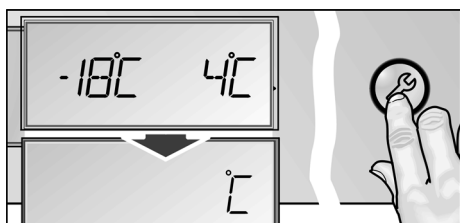

The first menu (temperature unit) is displayed.

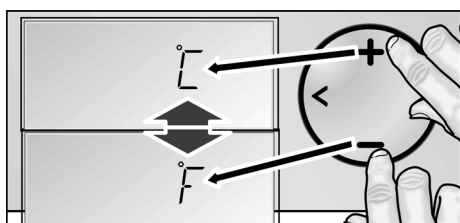

- Press the **+** or **-** setting button in order to switch between degrees Fahrenheit (°F) and degrees Celsius (°C).

- Press the setup button , in order to store the settings. The set temperature is displayed again in the fascia.

Language setting

When the appliance is operated, all messages are displayed in fascia in English.

Alternatively, the display languages can be selected corresponding to the table above.

- Press setup button .
- Press the selection button **>**, until *ENGLISH* is displayed.

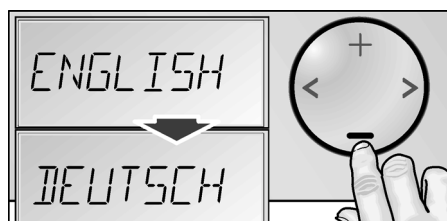



- Press the **+** or **-** setting button, until the desired language is displayed.
- Press the setup button , in order to store the settings. The set temperature is displayed again in the fascia.

Energy saving mode

If the energy saving function (eco function) is activated, the appliance switches to energy saving operation. This energy saving function is preset at the factory in order to reduce energy consumption. The background illumination of the fascia is likewise reduced.

To switch the energy saving function on:

- Press setup button .
- Press the selection button , until *ECO MODE* and the current setting (**OFF**) is displayed.
- Press the **+** or **-** setting button, in order to reset the setting.



- Press the setup button , in order to store the settings.



The word *ECONOMY* is displayed in the fascia.



This function is then ended:

- by switching the eco function off in the setup mode,
- by activating the fast cooling or fast freezing function,
- by changing the target temperature of the appliance,
- by switching the appliance off using the on/off button .

Door rail heater

To prevent condensation, the door rail heater can be switched on and off as required.



Switching on

1. Press setup button .
2. Press the selection button , until *DRY DOOR* and the current setting (**OFF**) is displayed.



3. Press the **+** setting button, in order to reset the setting.
4. Press the setup button , in order to store the settings.

Switching off IWD off

1. Press setup button .
2. Press the selection button , until *DRY DOOR* and the current setting (**ON**) is displayed.
3. Press the **-** setting button, in order to reset the setting.
4. Press the setup button , in order to store the settings.

Alarm function

Switching off the warning signal

Press the alarm button  to switch off the warning signal.

Door alarm

The door alarm switches on if an appliance door is left open for longer than three minutes.



Close the door to switch off the warning signal.

Holiday mode

If leaving the appliance for a long period of time, you can switch the appliance to the energy-saving holiday mode.

Holiday mode settings:

- the appliance works in energy saving mode (see “Energy saving mode”);
- the interior illumination is switched off;
- fast cooling or fast freezing is then ended (if activated).

To switch the holiday mode on:

- Press Holiday button .



The **VACATION** symbol appears in the fascia under the eco-temperature preset at the factory.

To switch the holiday mode off:

- Press Holiday button .

The previous settings and temperature values are once again activated.



Rest mode

When Rest mode is switched on, the following settings are switched off:

- Fast cooling (if switched on).
- Fast freezing (if switched on).
- Ice maker.
- Accoustic signal.
- Interior light.
- Messages in the display field.
- The background illumination of the fascia is reduced.
- Buttons are locked.

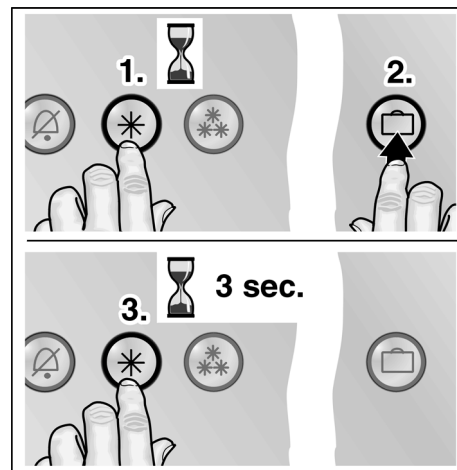
To switch on Rest mode:



- Press the fast cooling  button and keep it held down.
- Press Holiday button .
- Hold the fast cooling  button down for 3 seconds longer.

The symbol **VACATION** flashes on the display panel.



The background illumination in the fascia is switched off. **SABBATH** is displayed in the fascia. Rest mode is switched on.

To end Rest mode:

- Press Holiday button .

The previous settings and temperature values are once again activated.

Storing food in the refrigerator compartment

Pay attention when arranging food:

- Allow warm food and drinks to cool down outside the appliance.
- Wrap or cover food before placing in the appliance. This way the aroma and freshness is preserved. This is done likewise to help avoid the transfer of odours and colours onto plastic parts.
- Keep plastic parts and the door seal free of oil and grease.
- Bottles which contain a high percentage of alcohol must be sealed and stored in an upright position.

When buying food, please note:

The “purchase freshness” is important for the shelf-life of your food. The following principle applies: the fresher the supplies are when placed in the chiller section drawer, the longer they can be held for. When buying food, always note the degree of freshness.

Freezing and storing food

Purchasing frozen food

When purchasing frozen food, observe the following:

- Check that the packaging is not damaged.
- Check the sell-by date.
- The temperature of the supermarket freezer should be $-18\text{ }^{\circ}\text{C}$ or lower. If not, the shelf life of the frozen food is reduced.
- Purchase deep-frozen food last. Wrap food in newspaper or place in a cool bag and take home.
- At home immediately place deep-frozen food in the freezer compartment. Use the deep-frozen food before the sell-by date runs out.
- Do not refreeze thawed food. Exception: If the food has been used for a ready meal (boiling or frying), this ready meal can be refrozen.

Freezing deep-frozen food

Freeze fresh and undamaged food only. To prevent food from losing its flavour or drying out, wrap the food in airtight film or place in containers. Food should be frozen solid as quickly as possible.

Packing food correctly:

- Place food in packaging.
- Remove all the air.
- Seal package tight.
- Label the wrapping with the contents and date.

The following products are not suitable for wrapping food:

Wrapping paper, greaseproof paper, cellophane, bin liners and used shopping bags.

The following products are suitable for wrapping food:

Cling wrap, polyethylene blown film, aluminium foil and freezer tins. These products are available from specialist outlets.

The following products are suitable for sealing the wrapped food:

Rubber bands, plastic clips, string, cold-resistant adhesive tape etc.

Bags and polyethylene blown film can be sealed with a film sealer.

Shelf life of frozen food

The storage period depends on the type of produce.

At a mean temperature:

Fish, sausage, ready meals and cakes and pastries	up to 6 months
Cheese, poultry, meat	up to 8 months
Vegetables, fruit	up to 12 months

Thawing frozen food

Depending on the type and application, select one of the following options:

- at room temperature,
- in the refrigerator,
- in an electric oven, with/without fan assisted hot-air,
- in the microwave.

Note

Do not refreeze food which is beginning to thaw or which has already thawed. The food cannot be refrozen until it has been prepared (boiled or fried).

Usable capacity

Information on the usable capacity can be found on the rating plate.

Maximum freezing capacity

Food should be frozen solid as quickly as possible. Only then will vitamins, nutritional values, appearance and flavour be retained.

Information about the max. freezing capacity within 24 hours can be found on the rating plate.

The maximum freezing capacity is reached in the upper area of the freezer space.

Ice maker

The ice maker makes ice cubes.

The ice maker starts to make ice cubes as soon as the appliance has reached the set temperature.

If the ice cube container is full, the ice maker automatically switches off.

The ice maker can make approx. 1.3 kg ice cubes within 24 hours.

Do not place bottles or food in the cube container in order to cool them quickly. The ice maker may block and be damaged.

Switch on the ice maker

- Make sure that ice maker container is its place and locked into position.



- Press the ice maker button  on the control panel.
The symbol is lit on the display panel **ICE**.

Important information

If the ice cube maker is used for the first time and/or a long period of not being used, do not use the ice which is produced in the first day for hygiene reasons. Throw the ice cubes away and clean the container!

Switch the ice maker off

Note

Before switching off the ice maker, it is most important that you switch the water supply to the appliance off for a few hours.

To switch the ice maker off:

- Press the ice maker button  on the control panel.

Removing and cleaning the ice cube container

If ice cubes have not been dispensed for a prolonged period, they will shrink, have a stale taste and stick together.

- Remove the ice cube container.
- Pull out the container, empty and clean with lukewarm water.
- Thoroughly rub the container and endless screw transportation mechanism dry so that new ice cubes cannot freeze to them.
- Inserting the ice cube container.

Ice cube production continues.

Tips for saving energy

- Install the appliance in a cool, well ventilated room, but not in direct sunlight and not near a heat source (e.g. radiator, cooker, etc.). If required, use an insulating plate.
- Allow warm food and drinks to cool down before placing in the appliance.
- Thaw frozen food by placing it in the refrigerator. Use the coldness of the frozen food to cool food.
- Open the appliance door as briefly as possible.

Operating noises

Normal operating noises

Humming – refrigerating unit is running. The fan in the circulating air system is running.

Bubbling, gurgling or whirring noises – refrigerant is flowing through the tubing.

Clicking – motor is switching on or off.

Noises which can be easily rectified

The appliance is not level

Align the appliance with the aid of a spirit-level.

Use the height-adjustable feet or place packing underneath them.

Drawers, baskets or storage areas wobble or stick

Please check the removable parts and re-insert them if required.

Receptacles are touching each other

Please move bottles or receptacles away from each other.

Thawing the appliance

The appliance starts to defrost automatically.

Switching off and disconnecting the appliance

Switching off the appliance

- Press the on/off button ①.

Disconnecting the appliance

If you do not use the appliance for a prolonged period:

- Take all food out of the appliance.
- Switch off the appliance.
- Pull out the mains plug or switch off the fuse!
- Empty the ice cube holder (see “Ice maker”).
- Clean the appliance interior (see “Cleaning the appliance”).
- To prevent odours, leave the doors open.

Cleaning the appliance

⚠ Warning

Never clean the appliance with a steam cleaner!

Water used for cleaning must not drip onto the fascia or light.

⚠ Caution

Do not use abrasive or acidic cleaning agents and solvents.

Never clean shelves and containers in the dishwasher.
The parts may warp.

- Press the on/off button (I) and switch the appliance off! Pull out the mains plug or switch off the fuse!
- Clean the appliance with lukewarm water and a little washing-up liquid. Water used for cleaning must not drip onto the fascia or light.
- Clean the door seal with water only and dry thoroughly with a cloth.
- Remove dirt on the ventilation and air release openings using a vacuum cleaner.
- Clean the surface of the appliance using a damp cloth. Afterwards, rub dry.

After cleaning:

- Insert the plug and/or switch the fuse on.
- Press the on/off button (I) and switch the appliance on.

Odours

If you experience unpleasant odours:

- Press the on/off button (I) and switch the appliance off!
- Take all food out of the appliance.
- Clean the interior. See section "Cleaning the appliance".
- Clean all packages.
- Seal strong smelling food in order to avoid odours from forming.
- Press the on/off button (I) and switch the appliance on.
- Storing food in the appliance.
- Check whether the formation of odours is still occurring after 24 hours.
- Change the activated carbon air filter, see "Changing activated carbon air filter".

Warning messages via the display

If several warning notices appear at once, see to each warning in turn.

As long as a warning is displayed, no buttons can be pressed.

Door alarm



Cause

One door of the appliance has not been closed correctly or has been open too long.

Remedial action

Press the alarm button (A). Close the door.
The display goes out.

Sensor failure

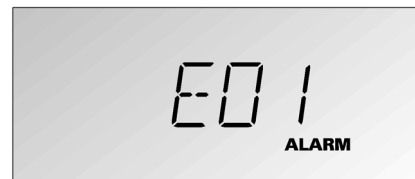

Cause

A technical defect on the appliance is possible.

Remedial action

Call Customer service.

Low voltage



Cause

The mains voltage falls below the permitted limiting value.

Remedial action

No button actuations are possible. When the mains voltage reaches the stipulated value again, the warning message goes out. If the warning message lasts for longer, inform the energy supply company.

Water filter

⚠ Warning

Do not use the appliance in places where the water quality is risky or not sufficiently known about without suitable disinfection, before and after filtering.

⚠ Warning

- After installing a new filter, always discard the ice produced within the first 24 hours after switching on the ice maker.
- If the ice has not been used for a prolonged period, pour all ice cubes out of the container and also discard the ice produced within the next 24 hours.
- If the appliance or the ice has not been used actively for several weeks or months or if the ice cubes have an unpleasant taste or odour, call customer service.
- As the service life of the filter depends on the local water conditions, the filter is not guaranteed.

A replacement filter screen can be purchased from customer service or a specialist dealer.

More detailed information about spare parts and their prices are available from customer service or a specialist dealer.

Installing water filter

⚠ Warning

The water filter should be installed by customer service.

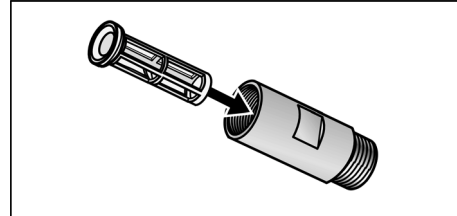

- Insert filter screen into the filter housing.

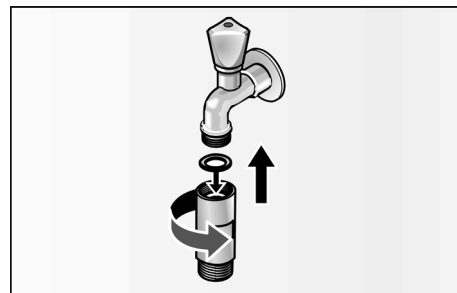

- Place seal in the filter housing and connect to the tap ($\frac{3}{4}$ " threaded connection).

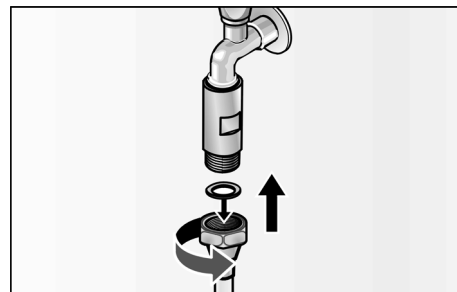

- Using an open-end wrench, connect water supply hose with seal to the filter housing.
- Carefully turn on the tap and check that the connection points are not leaking.

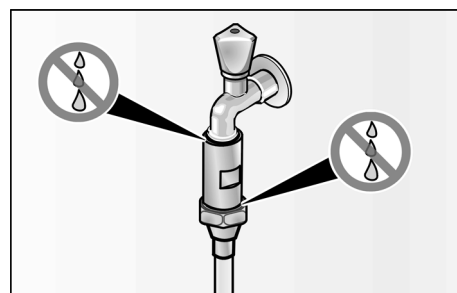

⚠ Warning

There must be no leaking water! If required, tighten the threaded connections with a higher torque.

Eliminating minor faults yourself

Before you call customer service: Please check whether you can eliminate the fault yourself based on the following information. Customer service will charge you for advice – even if the appliance is still under guarantee!

Appliance

Fault	Possible cause	Remedial action
Appliance has no refrigerating capacity. Interior light does not function. The display does not illuminate.	Power failure; the fuse has been switched off; the mains plug has not been inserted properly.	Check whether the power is on. The appliance must be switched on. Check whether the mains plug is secure.
The refrigerating unit is switching on more frequently and for longer.	Appliance door opened frequently.	Do not open the door unnecessarily.
	Large amounts of fresh food have been put away.	Activate fast cooling and/or fast freezing.
	The ventilation openings have been covered.	Remove obstructions and dirt.
The temperature in the refrigerator compartment or freezer compartment is too cold.	Temperature has been set too low.	Select a warmer temperature (see “Selecting the temperature”).
Interior light does not function.	The bulb is defective.	Replace bulb (see “Change the light bulbs”).
	Light switch is sticking.	Check whether it can be moved.
You experience unpleasant odours.	Strongly smelling food is not sealed.	Clean the appliance. Seal strongly smelling food (see “Odours”).

Ice maker

Fault	Possible cause	Remedial action
The ice maker doesn't work.	Ice maker is not connected to the mains supply.	Call Customer service.
	Ice maker does not contain any fresh water.	Ensure that the water is properly connected. If it is, call the customer service.
	The freezer space temperature is too high.	Check the freezer space temperature. Reduce it where necessary.
The ice maker does not make enough ice or the ice is deformed.	The appliance or ice maker has only just been switched on.	Approx. 24 hours is needed until ice production starts.
	A lot of ice has been taken.	Approx. 24 hours is needed until the ice cube container is filled again.
	Low water pressure.	The water pressure must be between 0.2 MPa and 0.8 MPa (2.0 bar and 8.0 bar) so that the appliance works properly.
	Screen on the water supply is blocked or damaged.	Call customer service.

Fault	Possible cause	Remedial action
The ice maker does not make any ice.	The ice maker is switched off.	Switch the ice maker on at the control panel.
	The appliance is not supplied with water.	Contact the installer or the water supply company.
	Water supply has kinks.	Turn off the water supply at the shut-off tap. Smoothen out the kinks, exchange where necessary.
	Low water pressure.	The water pressure must be between 0.2 MPa and 0.8 MPa (2.0 bar and 8.0 bar) so that the appliance works properly.
	Temperature in the freezer space is too high.	Temperature in the freezer space should lie between $-17\text{ }^{\circ}\text{C}$ and $-18\text{ }^{\circ}\text{C}$, adjust where necessary.
	Ice cube container is not properly inserted.	Check the position, re-insert where necessary.
	Incorrect shut-off tap installed.	Incorrect taps can cause low water pressure and damage to the appliance.
Ice forms in the inflow hose to the ice maker.	Low water pressure.	The water pressure must be between 0.2 MPa and 0.8 MPa (2.0 bar and 8.0 bar) so that the appliance works properly.
	Shut off tap incorrectly opened.	Open shut off tap fully.
	Temperature in the freezer space is too high.	Temperature in the freezer space should lie between $-17\text{ }^{\circ}\text{C}$ and $-18\text{ }^{\circ}\text{C}$, adjust where necessary.
Water runs from the appliance.	The water connection hose is not properly sealed.	Replace the hose with a manufacturer's original part.
	Incorrect shut-off tap installed.	Incorrect taps can cause low water pressure and damage to the appliance.
The water pressure is less than usual.	Low water pressure.	The water pressure must be between 0.2 MPa and 0.8 MPa (2.0 bar and 8.0 bar) so that the appliance works properly.
	Shut off tap incorrectly opened.	Open shut off tap fully and check for leaks. Check the minimum through flow.
	Incorrect shut-off tap installed.	Incorrect taps can cause low water pressure and damage to the appliance.
	Water supply has kinks.	Turn off the water supply at the shut-off tap. Smoothen out the kinks, exchange where necessary.
	Screen on the water supply is blocked or damaged.	Call customer service.
There are floating particles in the ice.	If water freezes and thaws again, particles are formed by mineral deposits.	The particles are not harmful! In the water supply this is a natural occurrence.

Change the light bulbs

⚠ Warning

Pull out mains plug or switch off fuse.
Risk of electric shock!

⚠ Caution

Do not touch the halogen bulb with your fingers.
Always use a soft cloth when inserting a halogen bulb.

Upper halogen lamps in the refrigerator compartment

Halogen lamps – model: 12 V/20 W/G4 base

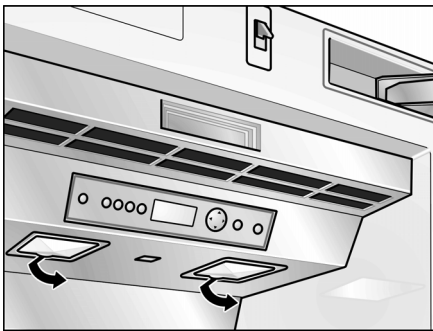

- Free the cover and remove.
- Remove the defective halogen bulb.

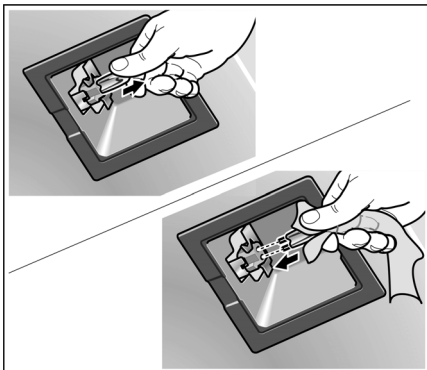

- Insert the new halogen bulb. Always use a soft cloth when inserting a halogen bulb.

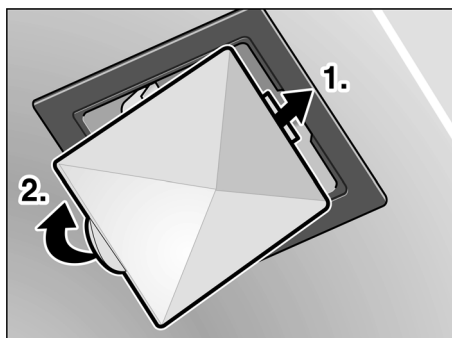

- Replace the cover and press it until it engages.

Side halogen lamps

Halogen lamps – model: 12 V/10 W/G4 base

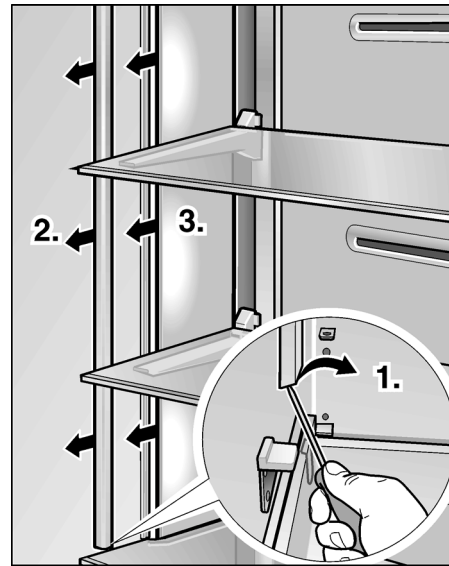

- Pull off the cover strip forwards.
To loosen the cover strip, use a screwdriver.
- Remove the pane forwards.
- Remove the defective halogen bulb.

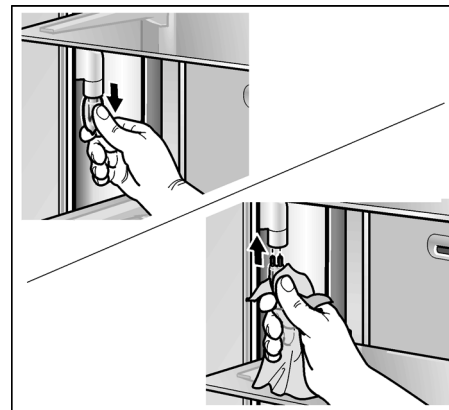

- Insert the new halogen bulb. Always use a soft cloth when inserting a halogen bulb.

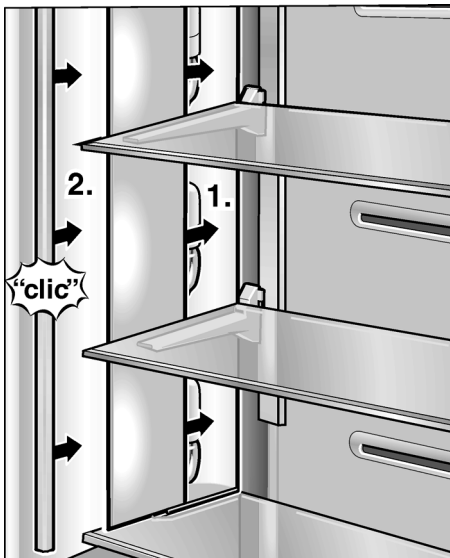

- Replace the panes.
- Insert the cover strip.

Changing activated carbon air filter

Replacement filters can be obtained from customer service or from a GAGGENAU specialist dealer.



- Opening the filter holder.

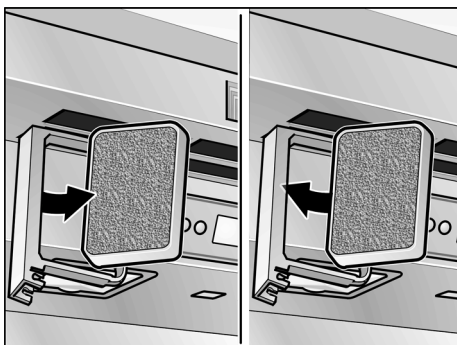

- Take out used activated carbon air filter.
- Insert new activated carbon air filter.



- Opening the filter holder.

Customer service

Check whether you can remedy the fault yourself on the basis of information provided in the "Eliminating minor faults yourself" section. Your local customer service can be found in the telephone directory or in the customer-service index.

Please provide customer service with the appliance product number (E-Nr.) and production number (FD).

To prevent unnecessary call-outs, please assist customer service by quoting the product and production numbers. This will save you additional costs.

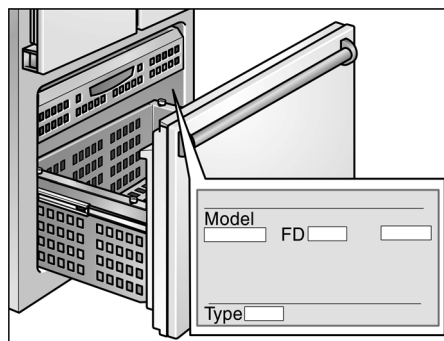

This information can be found on the product label.

Gaggenau Hausgeräte GmbH

Carl-Wery-Straße 34

D-81739 München

www.gaggenau.com

Subject to alterations.

GAGGENAU

9000 786 740
en (9206)