

Gaggenau

CM 450

de Kurzanleitung

en Quick Reference Guide

it Guida rapida

fr Mémento

es Instrucciones breves de manejo

nl Beknopte gebruiksaanwijzing



Latte Macchiato

Ein Beispiel / An example / Un esempio /
Un exemple / Un ejemplo / Voorbeeld

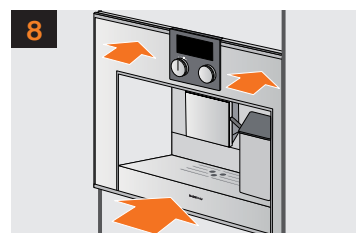
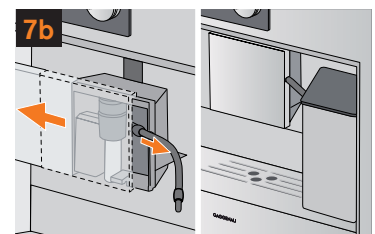
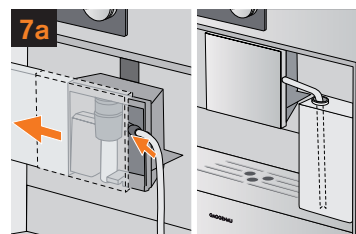
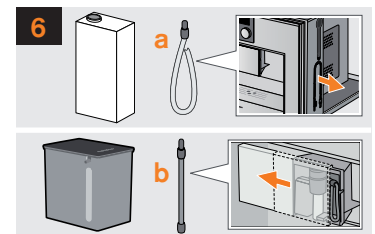
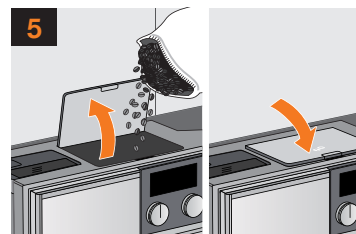
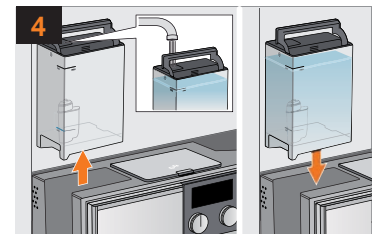
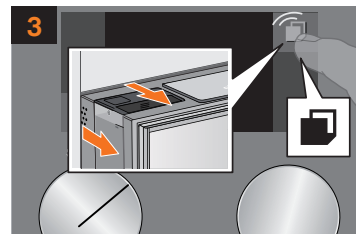
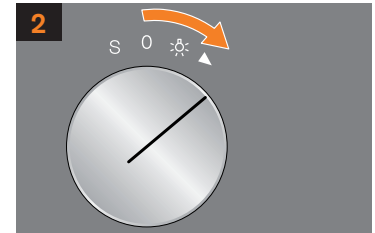
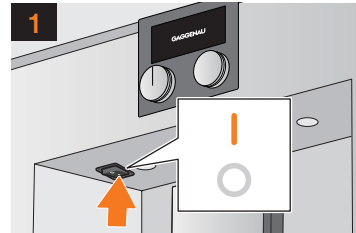

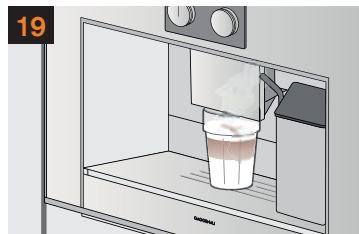
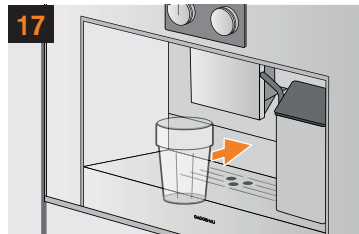
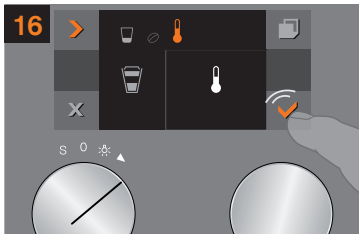
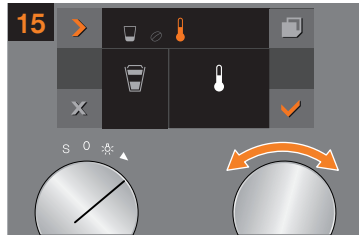
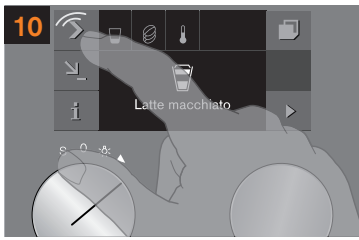

Brüheinheit reinigen / **Cleaning the brewing unit /**
Pulire l'unità di infusione / **Nettoyer l'unité de percola-**
tion / Limpieza de la unidad / **Zetgroep reinigen**

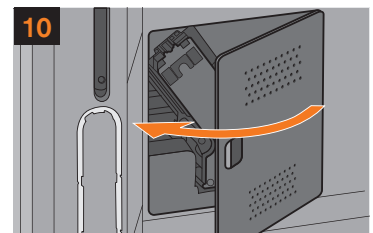
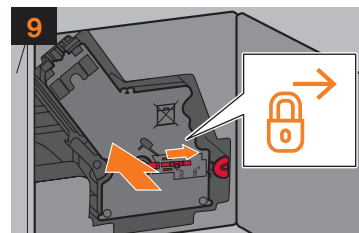
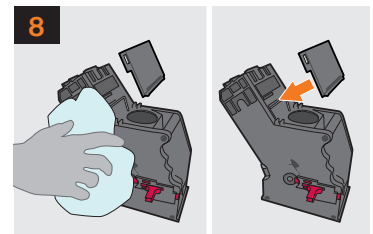
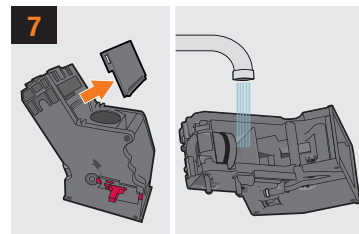
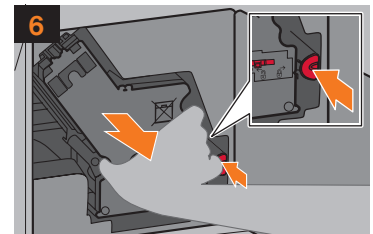
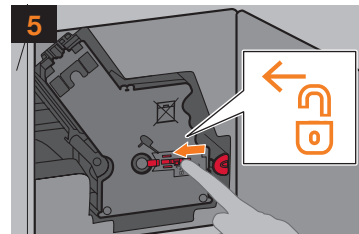
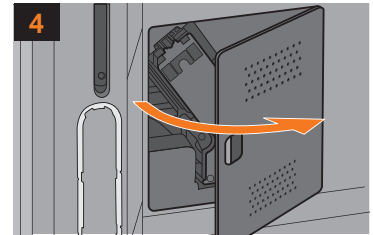
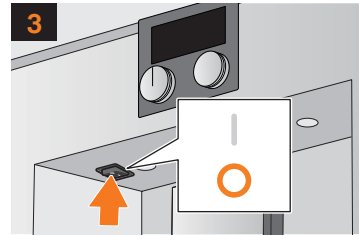
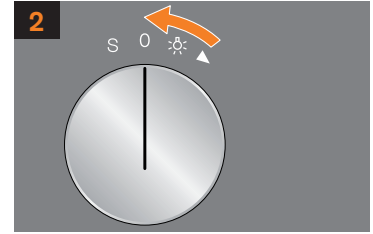
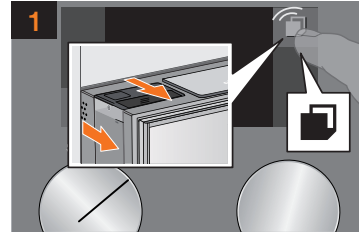



Milchsystem reinigen / **Cleaning the milk system** / Pulire il sistema latte / **Nettoyage du système mousser de lait** / Limpieza del sistema del leche / **Melksysteem reinigen**

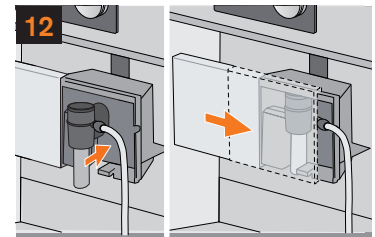
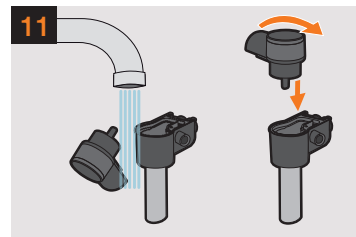
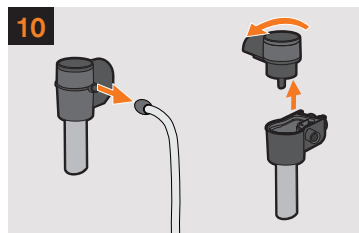
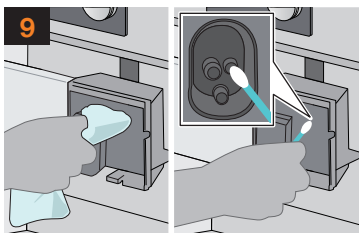
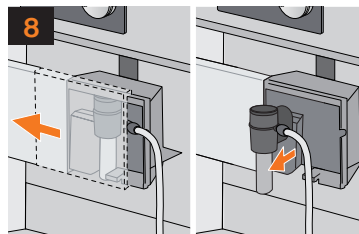
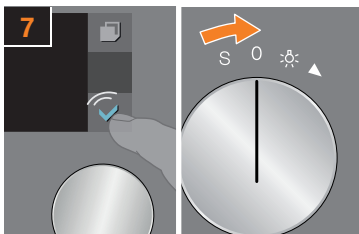
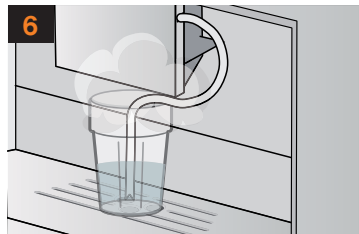
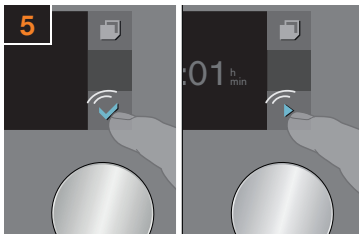
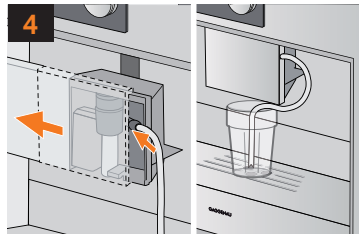
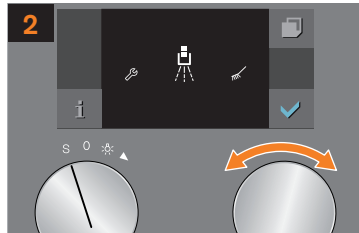
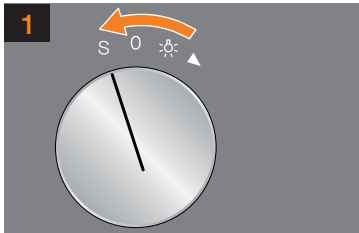

Entkalkungsprogramm / **Descaling programme** / Programma di decalcificazione / **Programme de détartrage** / Programa descalcificación / **Ontkalkingsprogramma**

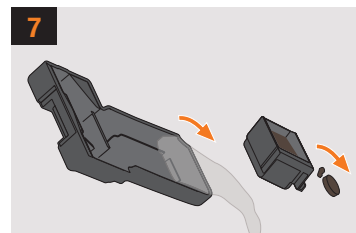
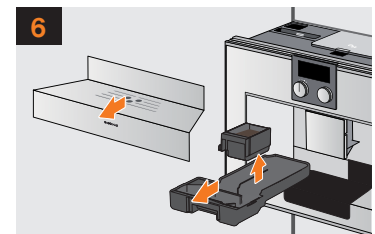
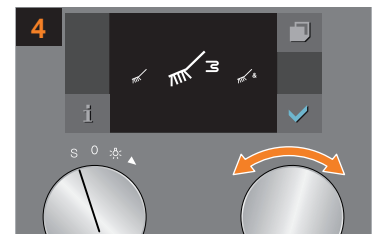
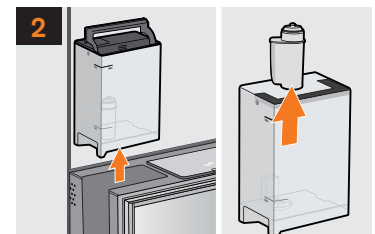
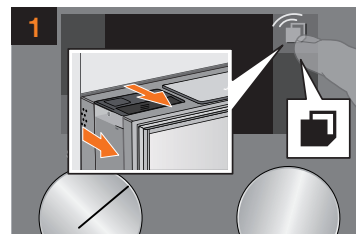

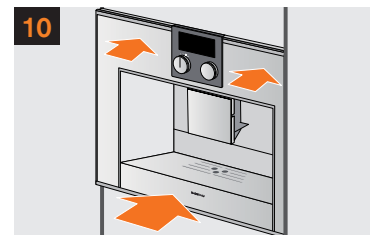
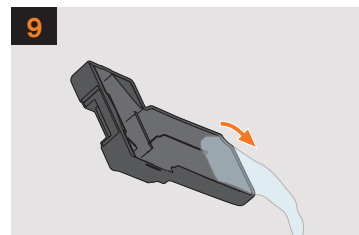
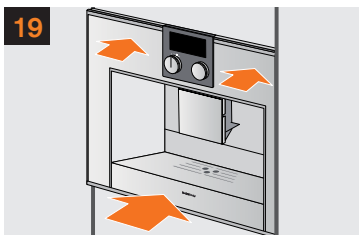
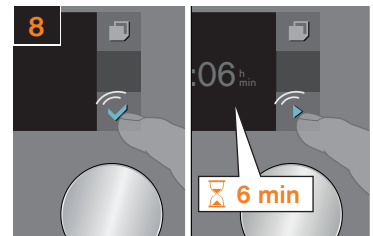
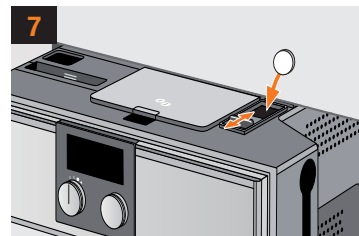
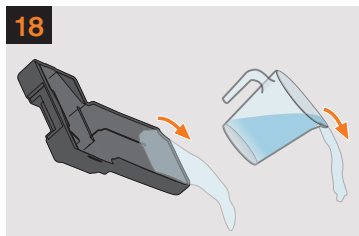
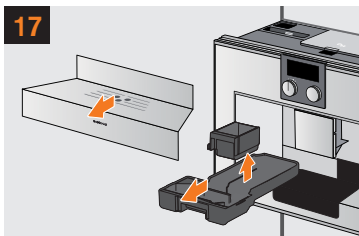
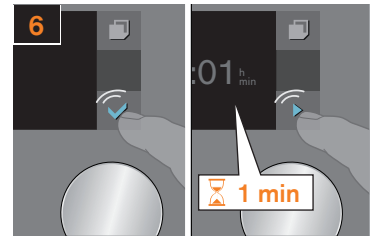
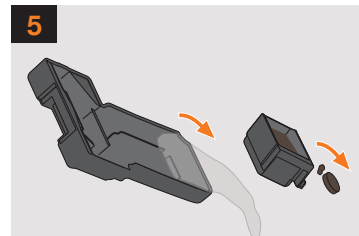
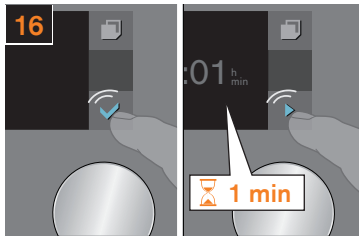
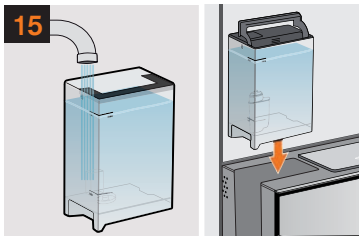
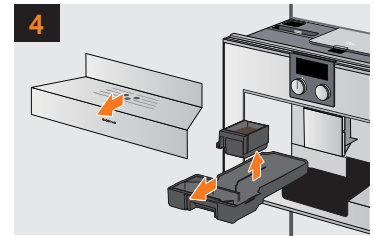
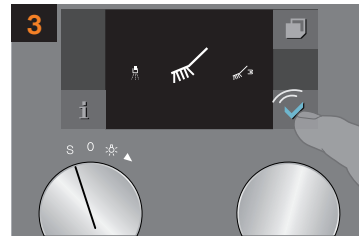
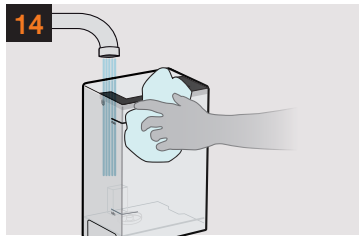
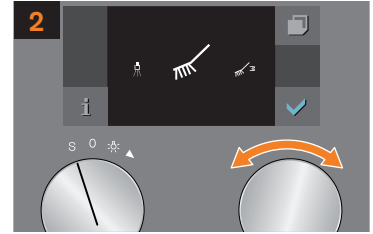
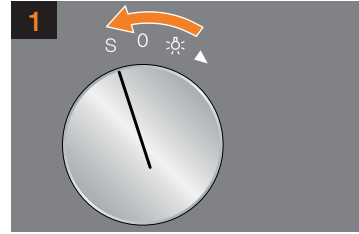
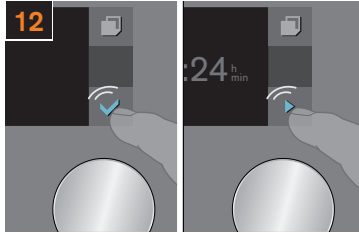
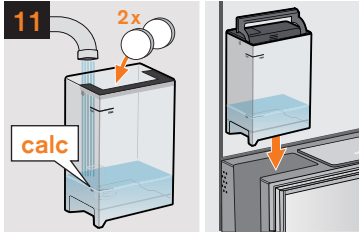
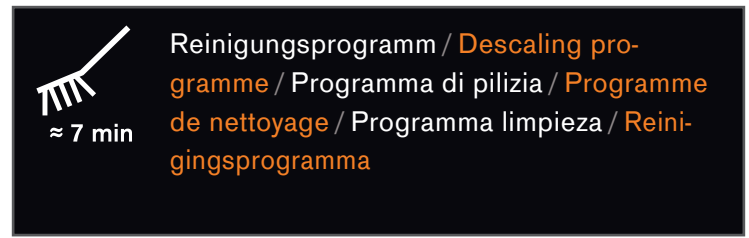
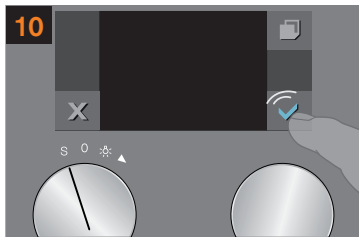
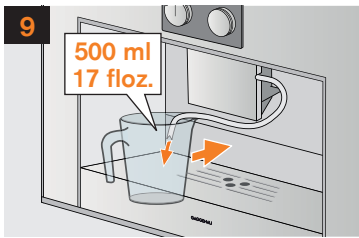

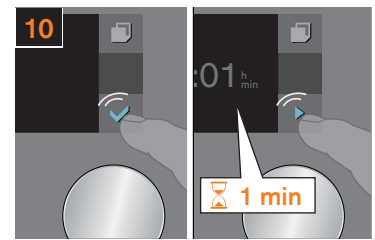
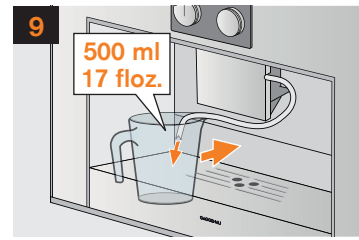
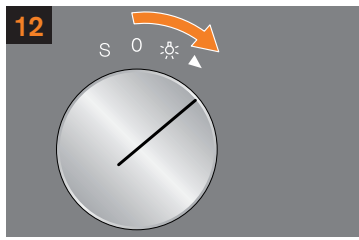
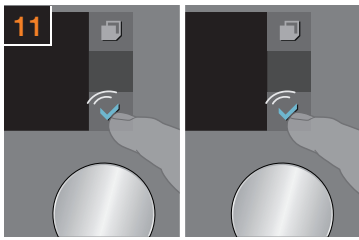

 &
 ≈ 32 min
 Entkalkungs- und Reinigungsprogramm /
 Descaling and cleaning programme / Pulizia
 e decalcificazione / Programme détartrage et
 nettoyage / Programa descalcificación y lim-
 pieza / Ontkalkings- en reinigungsprogramma

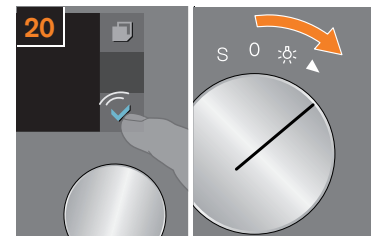
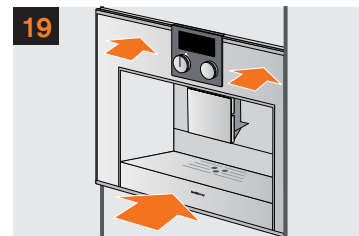
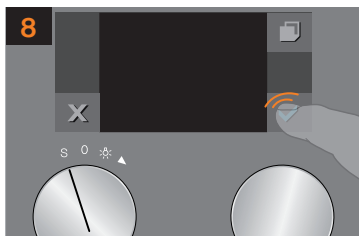
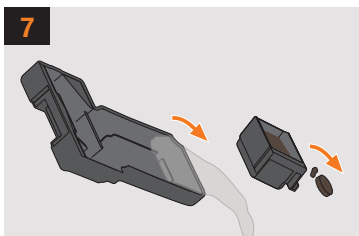
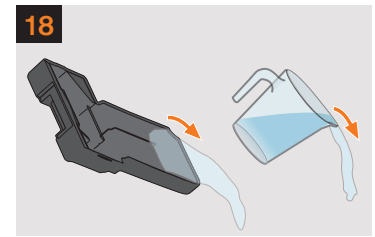
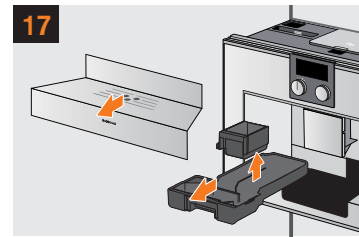
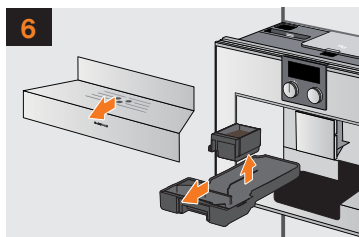
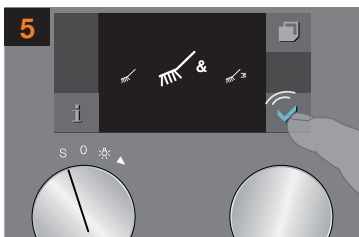
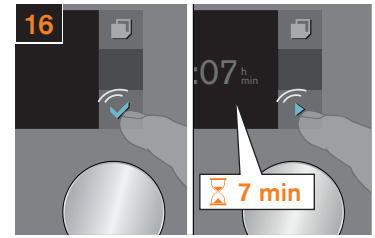
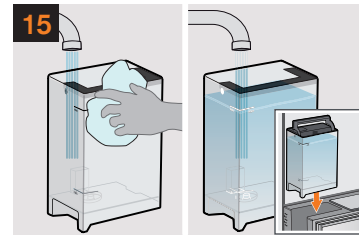
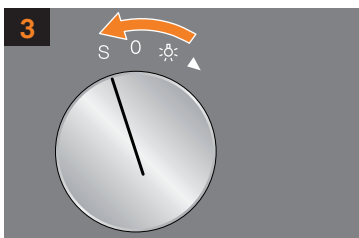
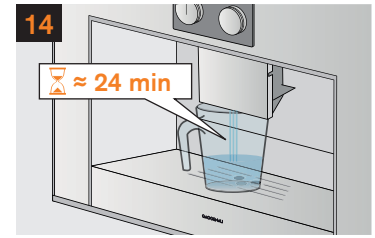
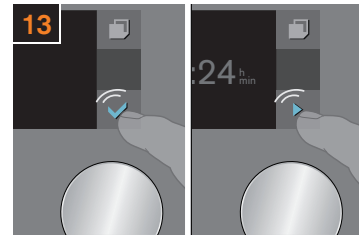
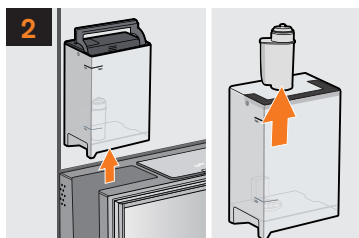
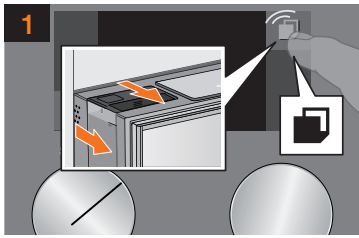
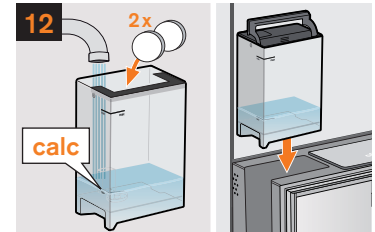
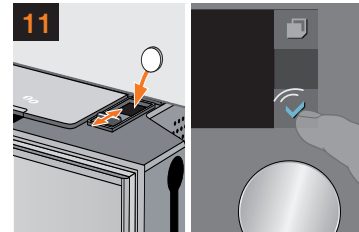

Kurzanleitung aufbewahren / **Quick Reference Guide Storage** / Conservare la guida rapida / **Rangement du Memento** / Guardar las instrucciones breves de manejo / **Beknopte gebruiksaanwijzing bewaren**

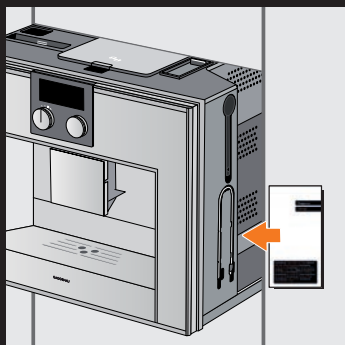

Gaggenau Hausgeräte GmbH

Carl-Wery-Straße 34

D-81739 München

www.gaggenau.com



GAGGENAU