



**de** Montageanleitung  
**en** Installation instructions  
**fr** Notice de montage  
**nl** Montagevoorschrift  
**it** Istruzioni per il montaggio  
**el** Οδηγίες τοποθέτησης  
**es** Instrucciones de montaje  
**pt** Instruções de montagem  
**sv** Monteringsanvisning  
**no** Monteringsanvisning  
**fi** Asennusohje  
**da** Monteringsvejledning  
**tr** Montaj kılavuzu

**ru** Инструкция по монтажу  
**cs** Montážní návod  
**pl** Instrukcja montażu  
**hu** Szerelési utasítás  
**hr** Uputa za montažu  
**mk** Упатство за монтажа  
**sl** Navodilo za montažo  
**sr** Uputstvo za montažu  
**et** Monteerimisjuhend  
**lt** Montavimo instrukcija  
**lv** Montāžas pamācība  
**sk** Návod na montáž  
**sq** Udhëzues për montim

**bs** Uputa za montažu  
**fa** راهنمایی مونتاژ  
**ar** تعليمات التركيب  
**ko** 설치 설명서  
**zh** 安装说明  
**uk** Інструкція з монтажу  
**ro** Instrucțiunea de montaj  
**bg** Упътване за монтаж  
**ja** インストールに関する指示  
**he** הוראות התקנה  
**id** Instruksi Pemasangan  
**kk** Іске қосу туралы нұсқаулар

**de** \*) über Kundendienst erhältlich  
**en** \*) Available from customer service  
**fr** \*) Disponible par le biais du service après-vente  
**nl** \*) Tegen meerprijs bij de Servicedienst verkrijgbaar  
**it** \*) Disponibili presso il servizio assistenza clienti  
**el** \*) Διατίθενται από την υπηρεσία τεχνικής εξυπηρέτησης πελατών  
**es** \*) Se puede adquirir a través del Servicio de Asistencia Técnica Oficial de la marca  
**pt** \*) Pode ser adquirido nos nossos Serviços Técnicos  
**sv** \*) kan fås via Service  
**no** \*) fåes hos kundeservice  
**fi** \*) Saatavissa huoltopalvelusta  
**da** \*) Kan købes hos serviceafdelingen  
**tr** \*) Yetkili servis üzerinden alınabilir  
**ru** \*) Можно получить в сервисном центре  
**cs** \*) K dispozici přes servisní službu  
**pl** \*) Do uzyskania w punkcie serwisowym  
**hu** \*) A vevőszolgáltatón keresztül kapható  
**hr** \*) može dobiti kod službe održavanja  
**mk** \*) се добива преку службата за купувачи

**sl** \*) Lahko nabavite v servisni službi  
**sr** \*) Može se nabaviti preko servisne službe  
**et** \*) küsige klienditeeninduselt  
**lt** \*) Ją galima gauti klientų aptarnavimo servise  
**lv** \*) Var saņemt servisa dienestā  
**sk** \*) Dostanete v službe zákazníkovi  
**sq** \*) Sigurohet nëpërmjet servisit  
**bs** \*) Može se dobiti preko servisne službe  
**fa** \*) از مرکز خدمات پس از فروش تهیه فرمائید  
**ar** \*) يمكن طلبها من مراكز خدمة العملاء  
**ko** \*) 고객센터 서비스 센터에서 구입 가능  
**zh** \*) 可通过售后服务部门购得  
**uk** \*) Можна отримати через сервісну службу  
**ro** \*) Se obține de la serviciul pentru clienți  
**bg** \*) може да се намери в специализираните сервиси  
**ja** \*) 顧客サービスから利用可能  
**he** \*) להשיג בתחנת שירות הלקוחות  
**id** \*) bisa didapatkan melalui Customer Service  
**kk** \*) Сервис қызмет көрсету орталығында алуына жатады



Ø4X36    Ø4X30

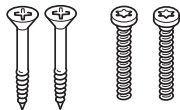

Ø4X15

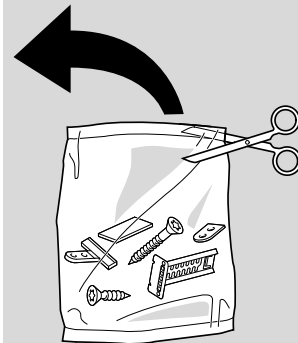
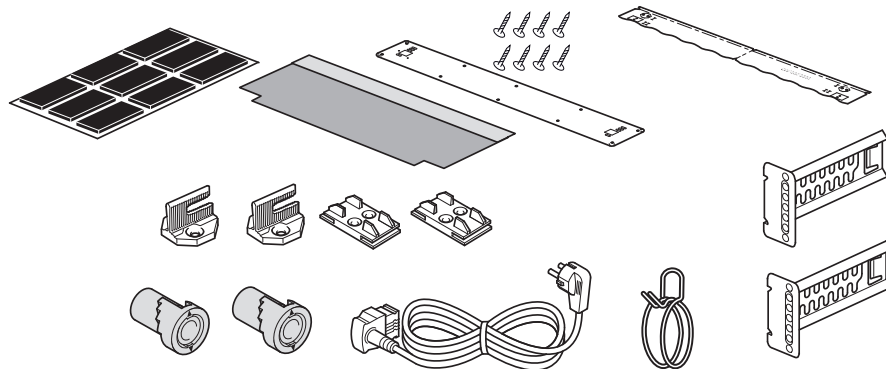
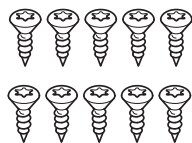

Torx T 20    Torx T 15

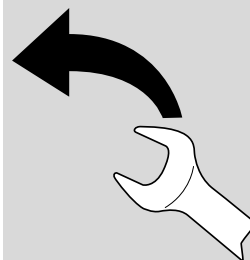
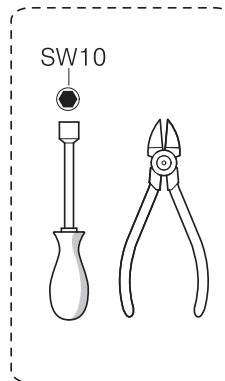
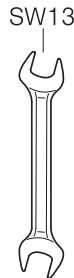
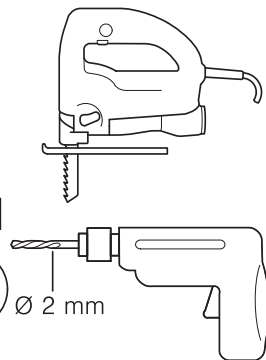
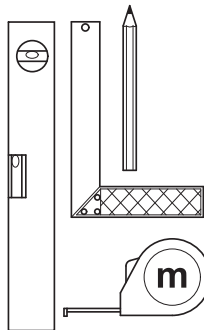
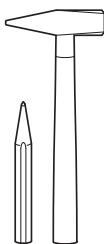
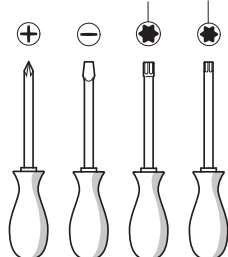

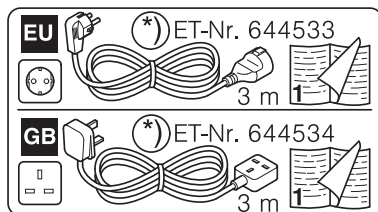
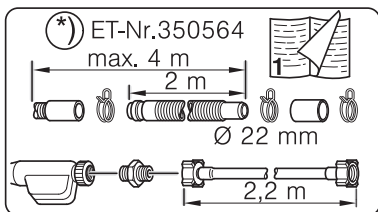
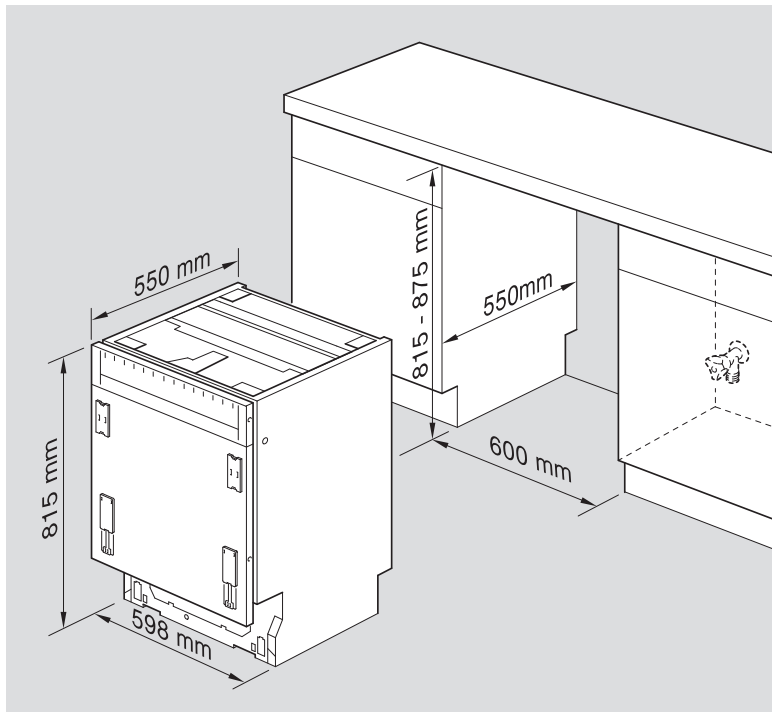
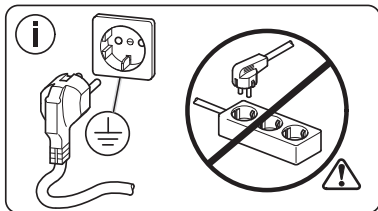
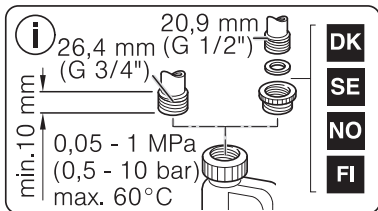
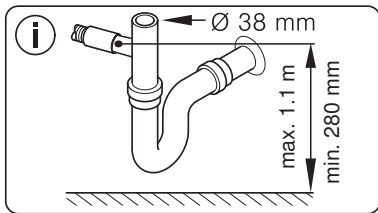

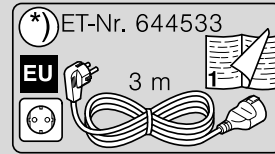
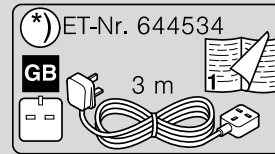
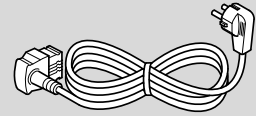
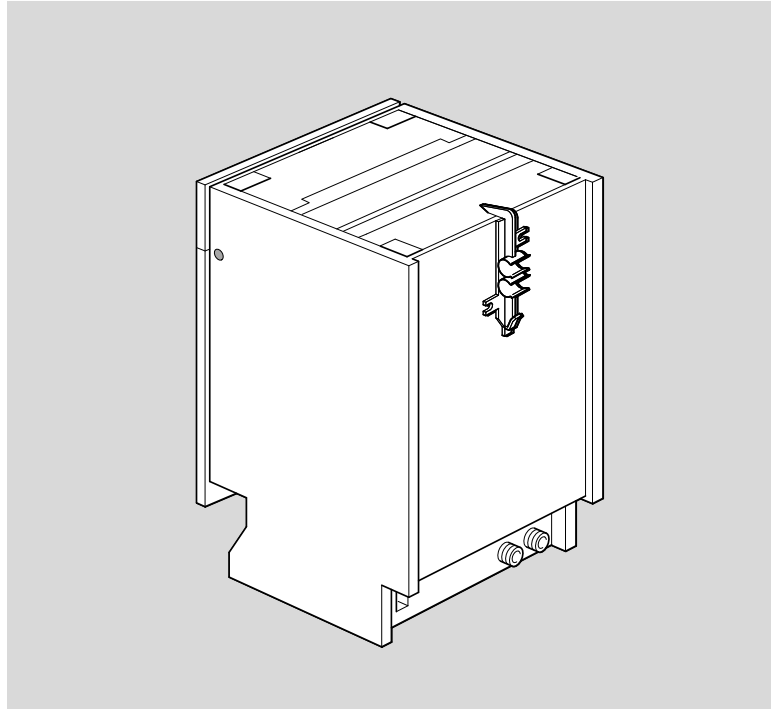
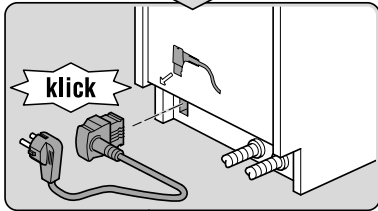
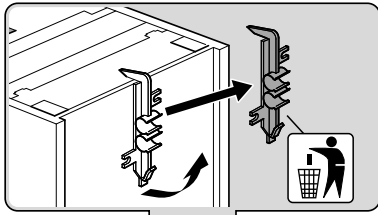

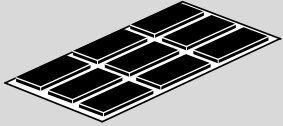
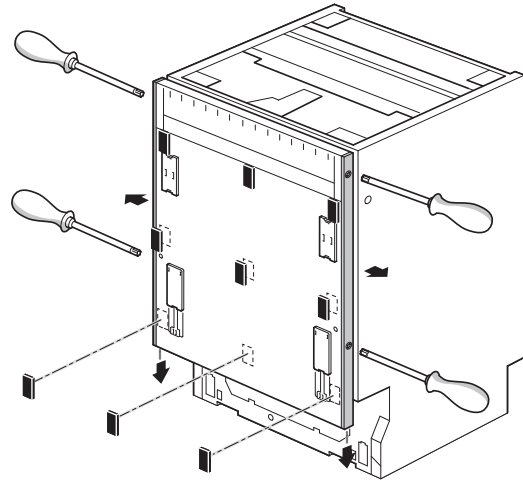
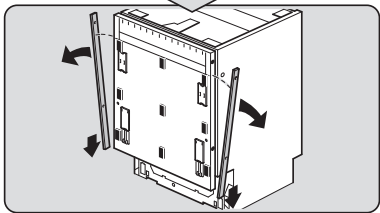
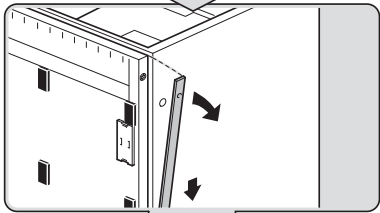
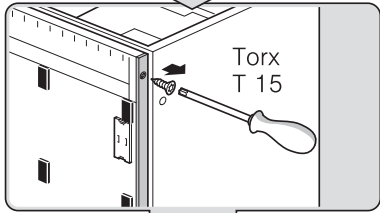
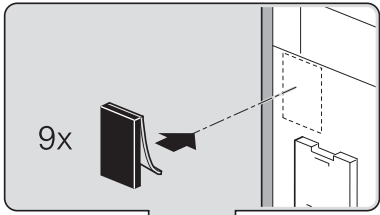

Torx  
T 15



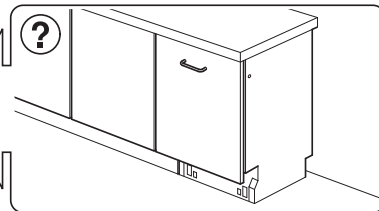
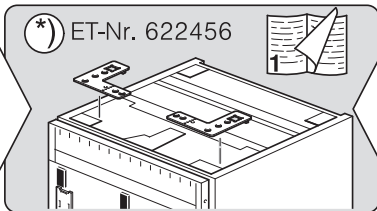
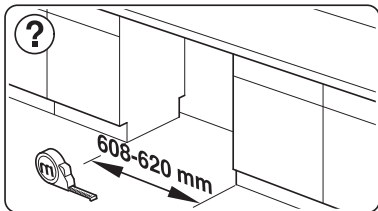
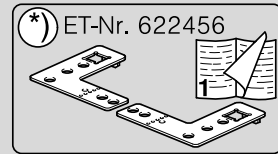
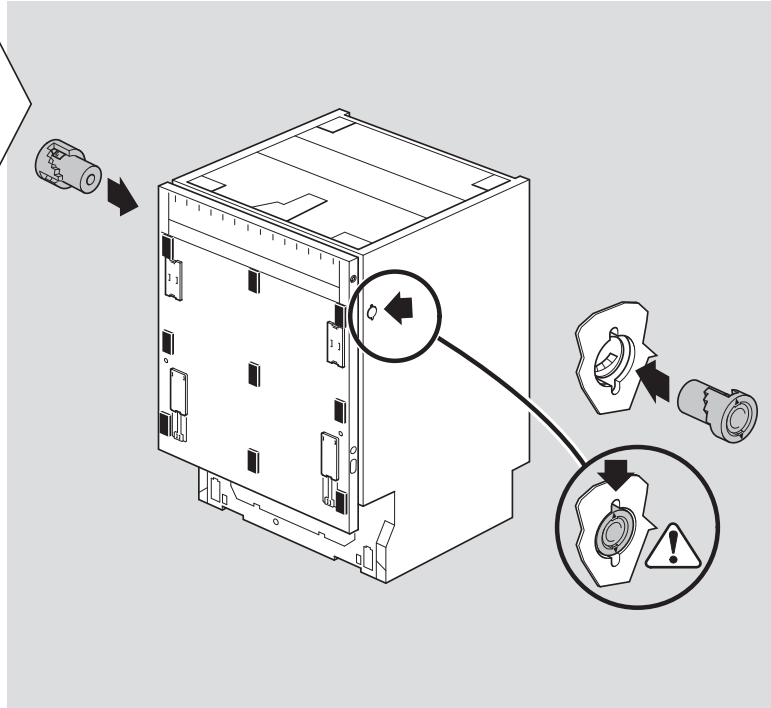
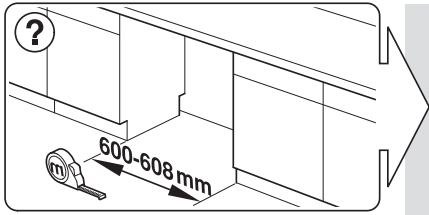

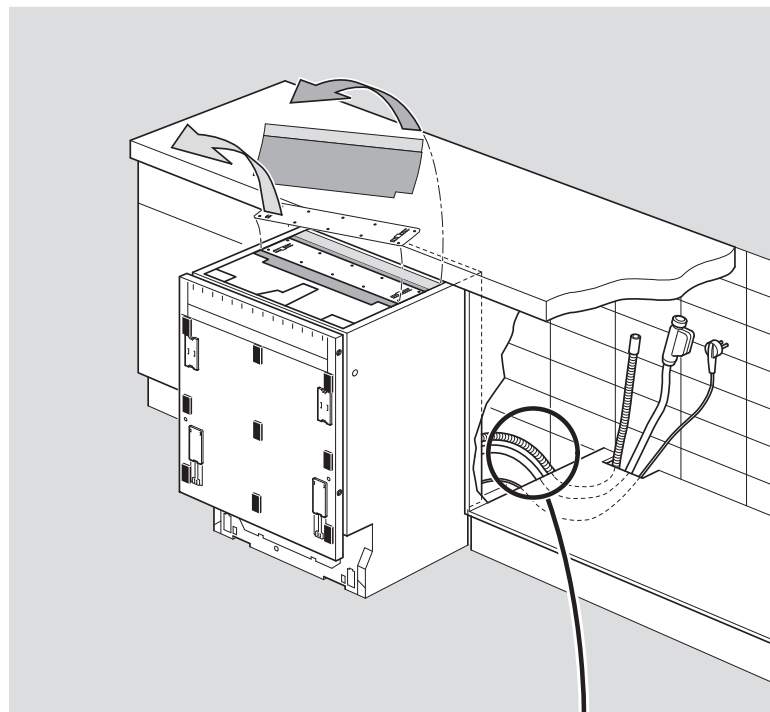
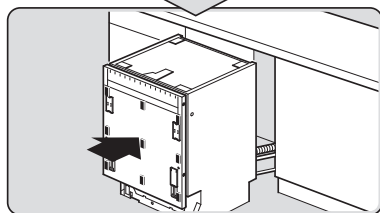
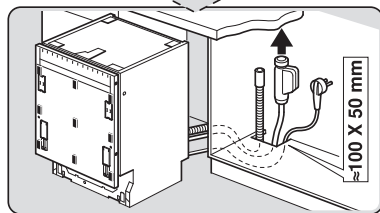
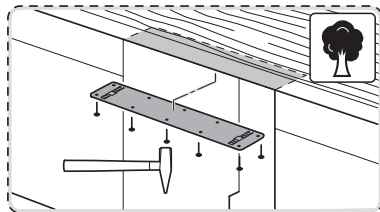
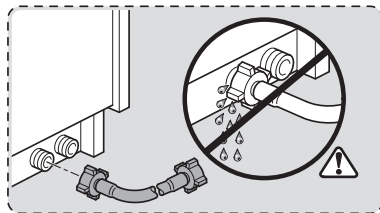

**nicht einklemmen**  
**do not pinch**  
**ne pas coincer**  
**No doblar**

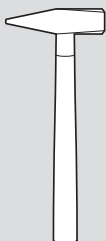
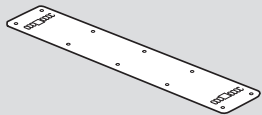
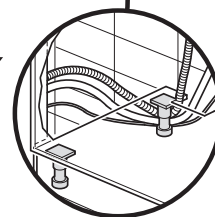

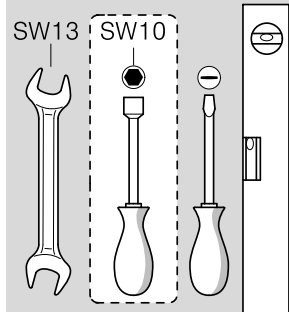
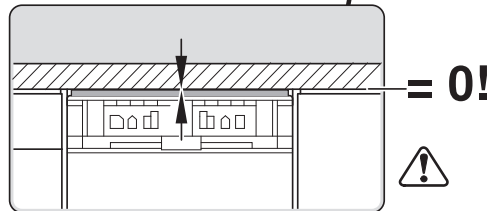
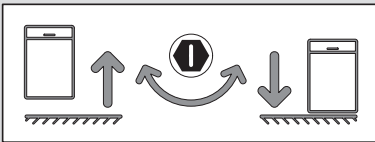
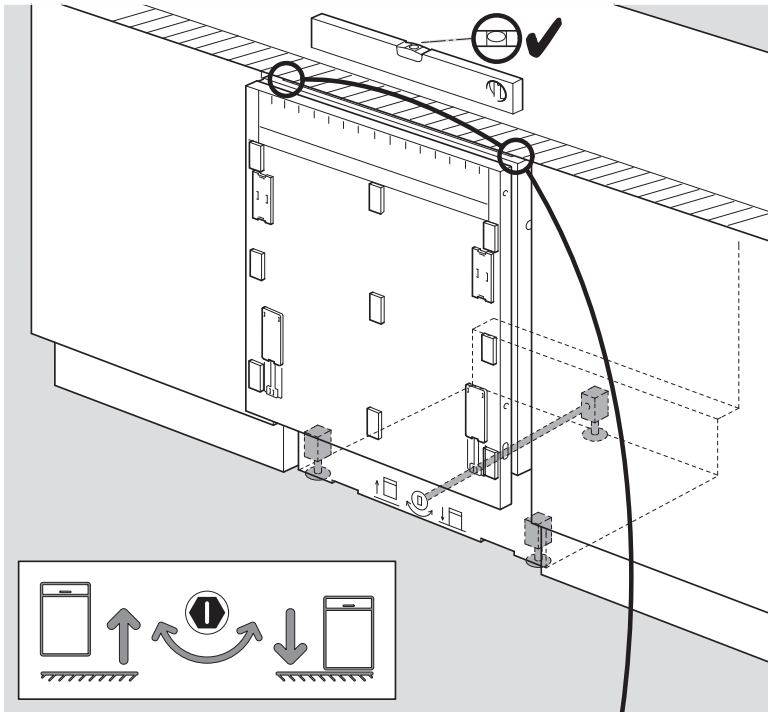
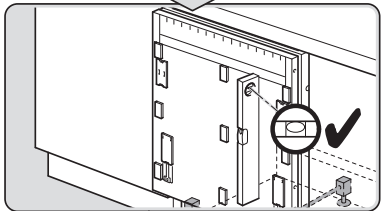
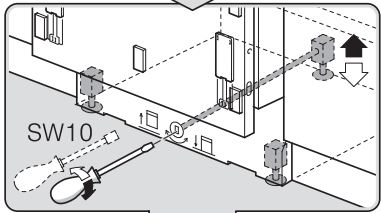
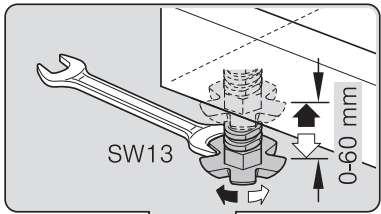



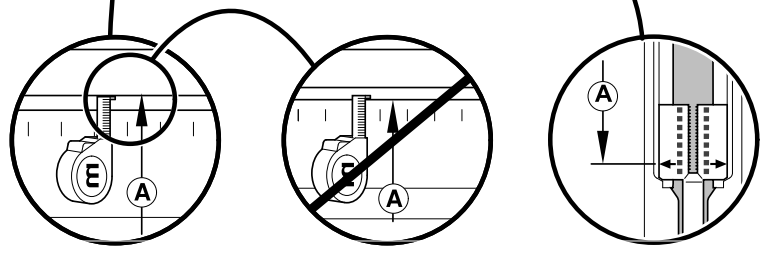
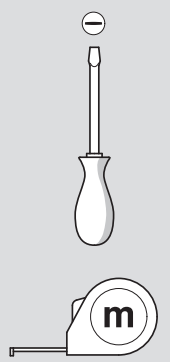
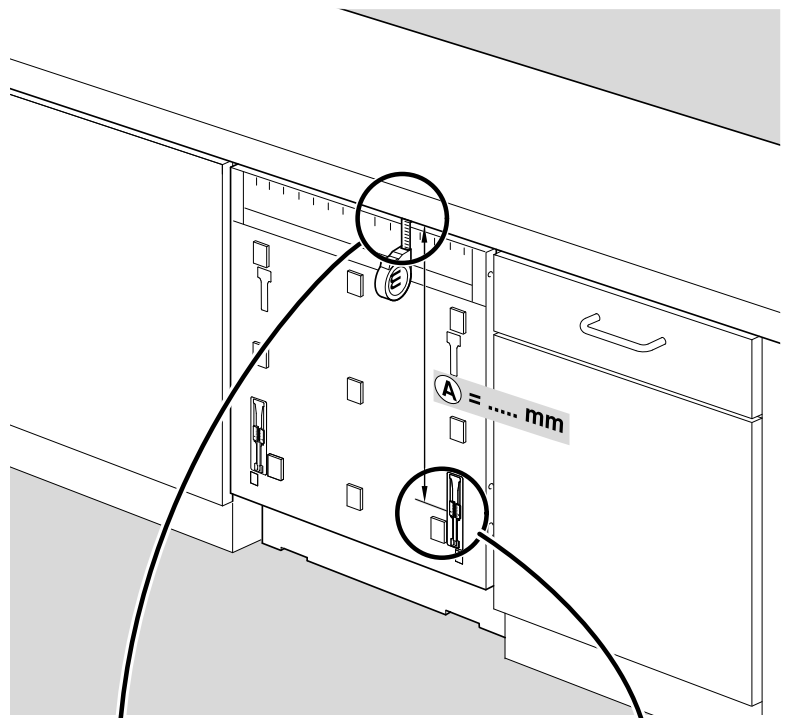
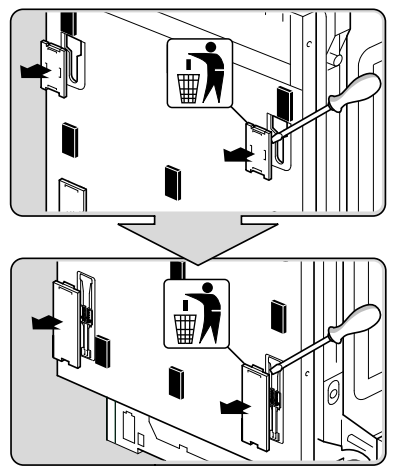

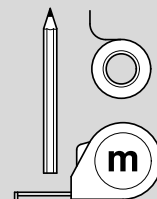
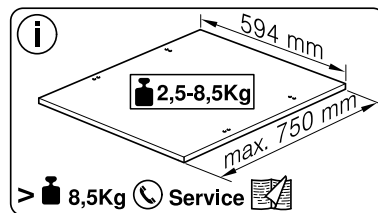
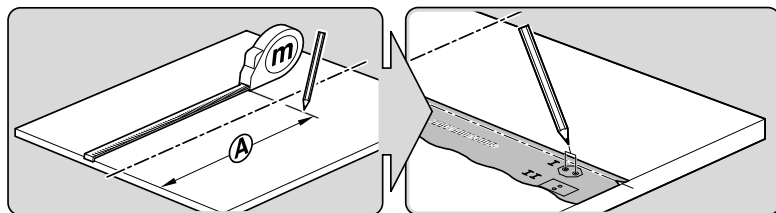
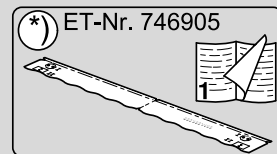
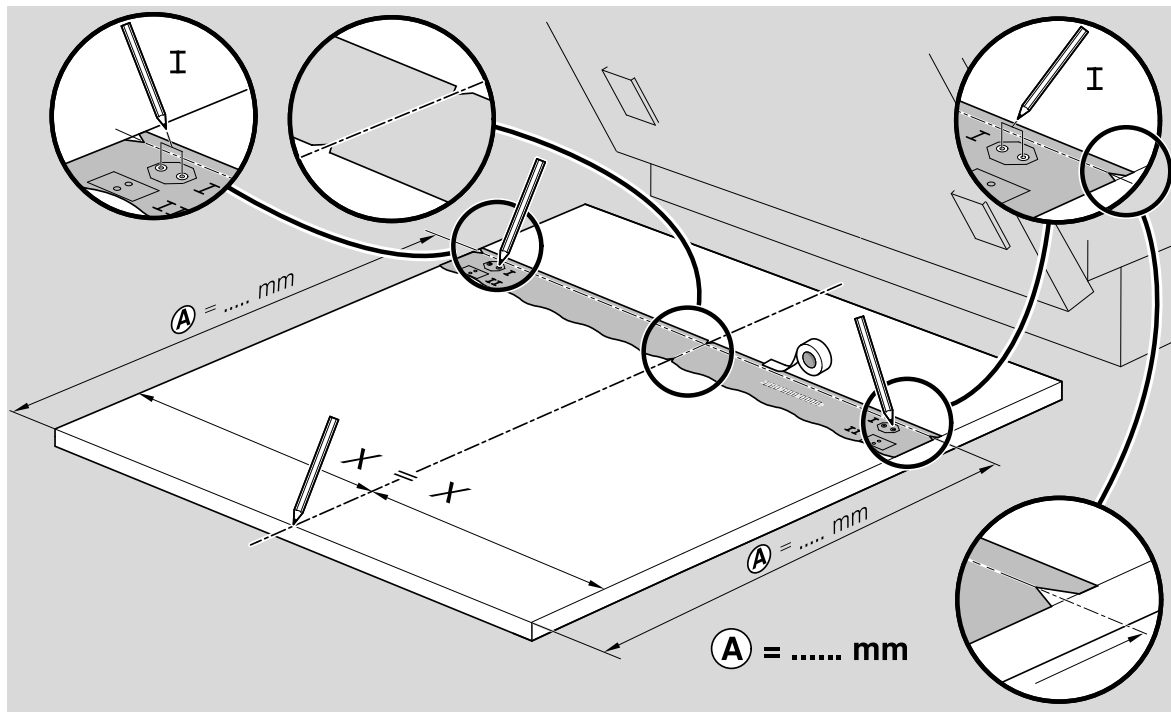

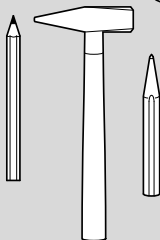
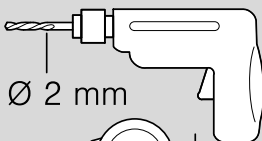
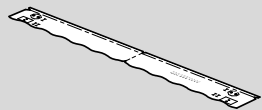
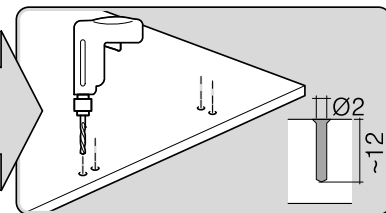
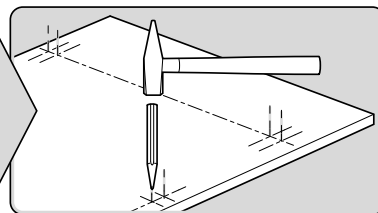
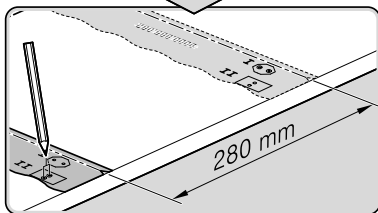
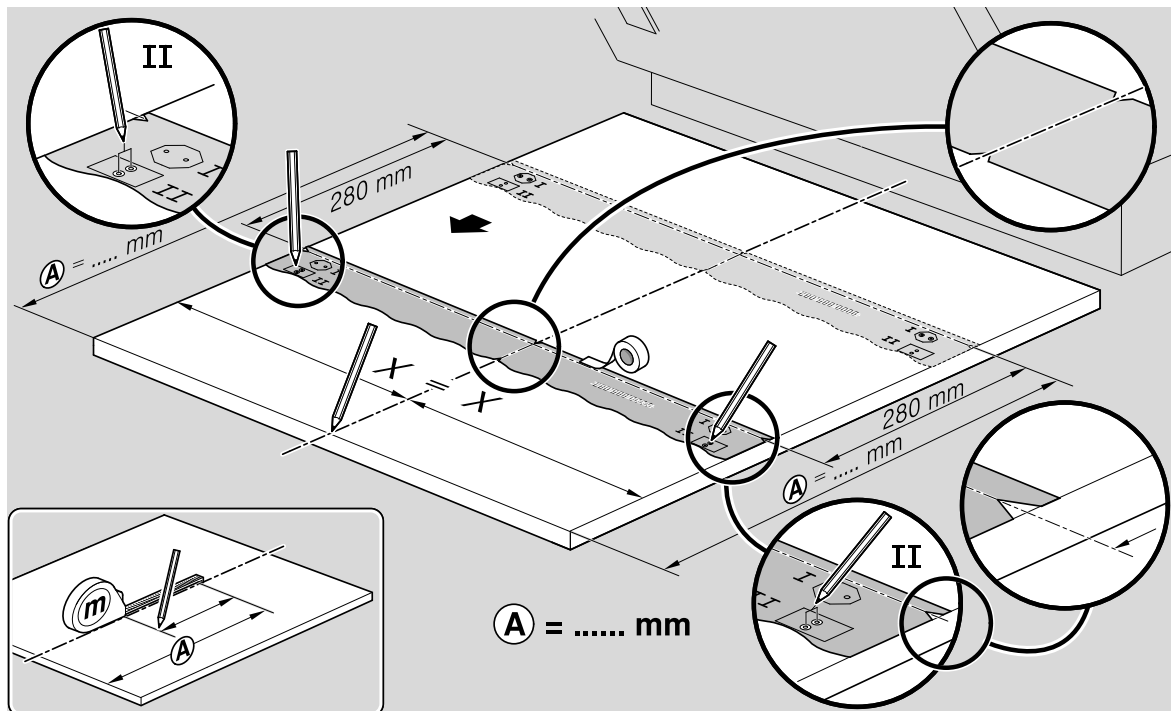

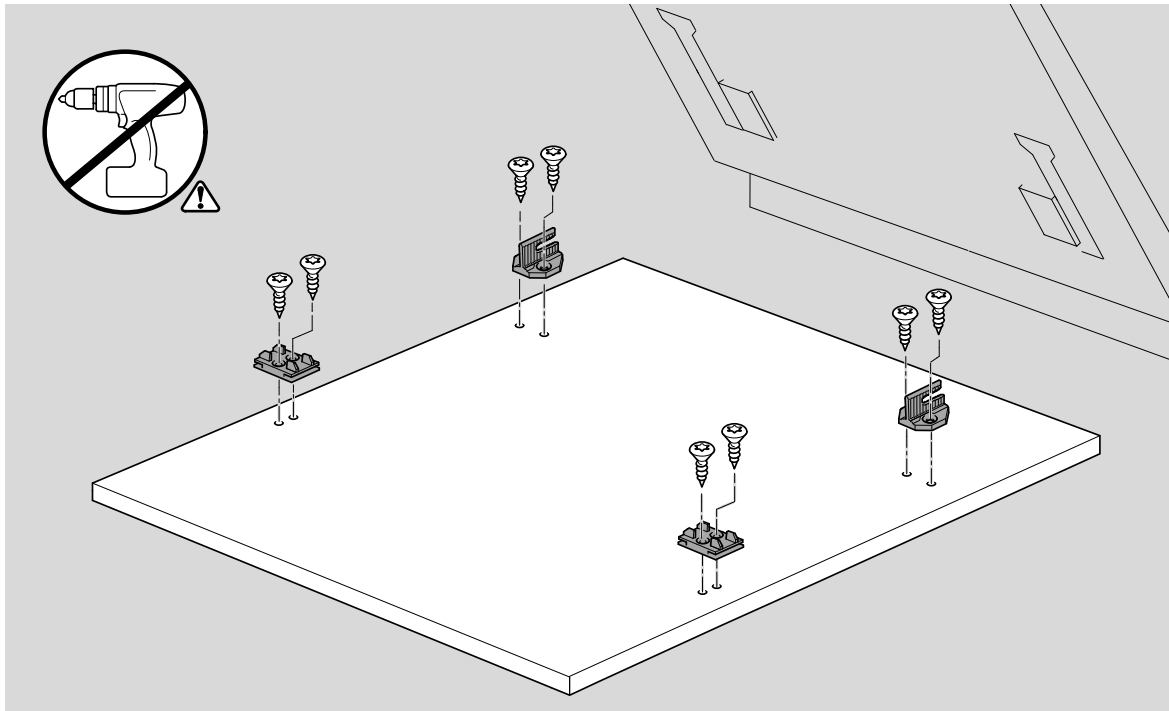

Ø4X15

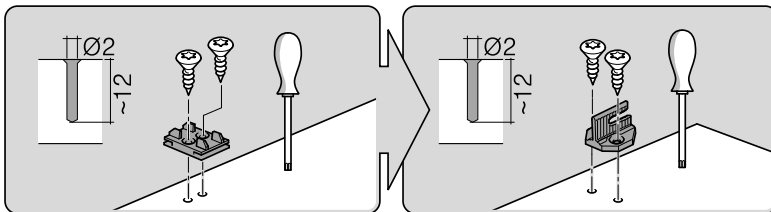
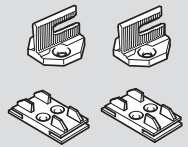
Torx  
T 20

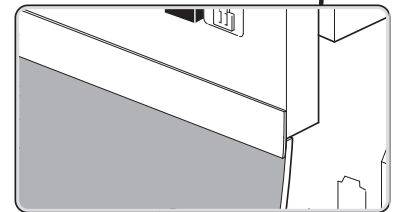
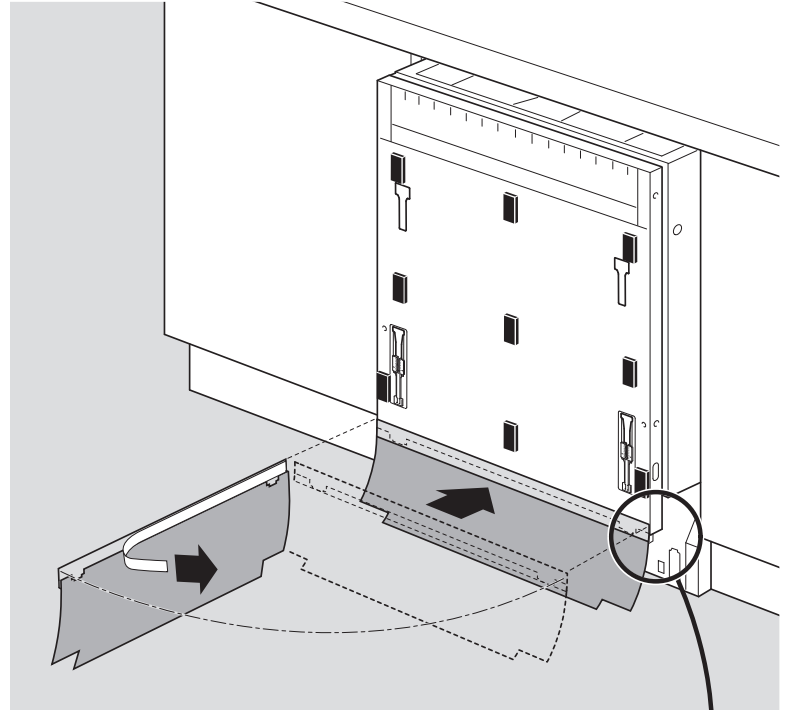
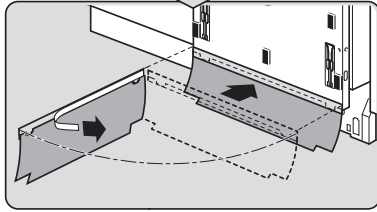
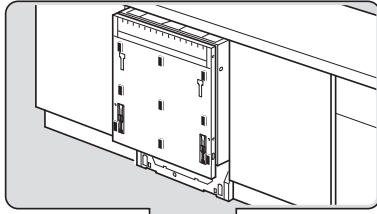

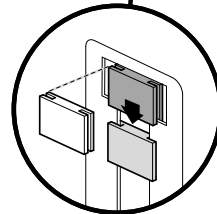
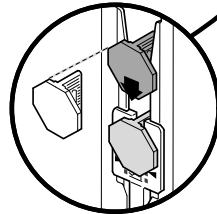
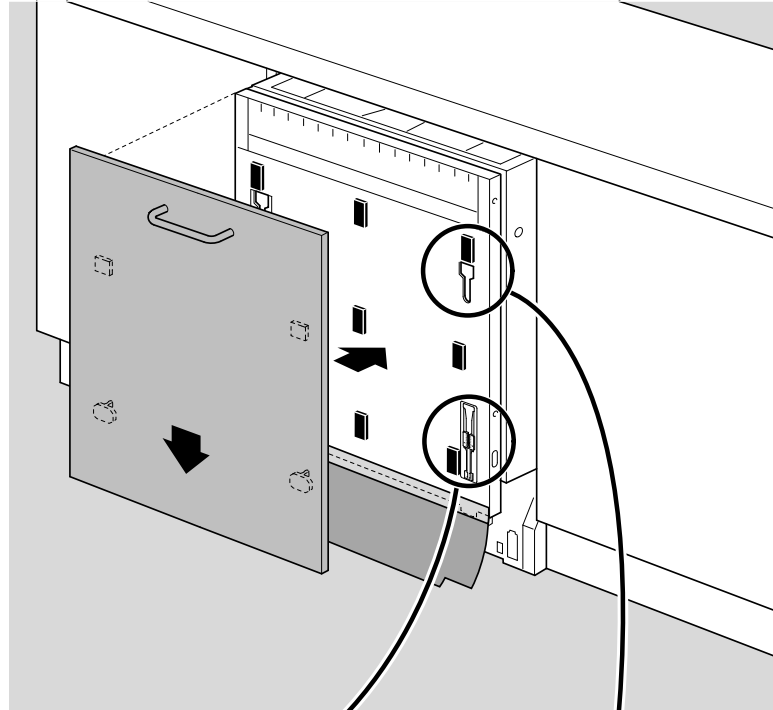
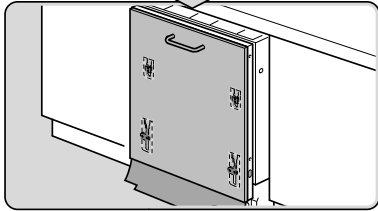
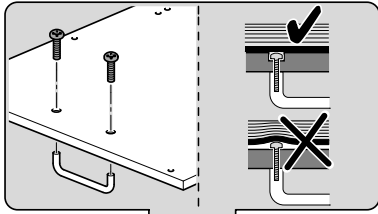

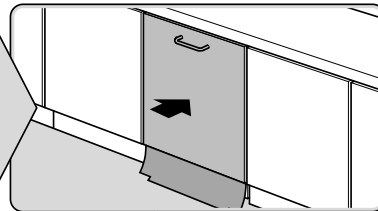
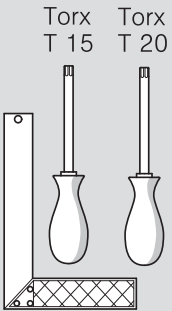
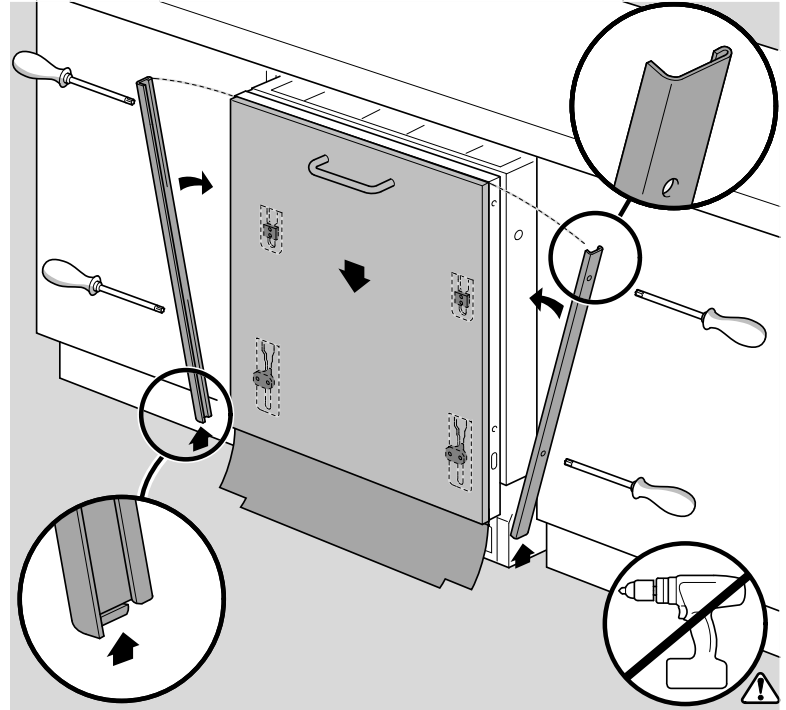
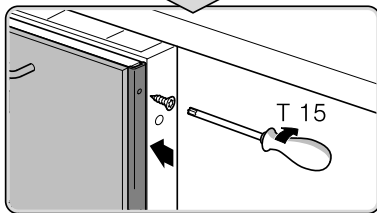
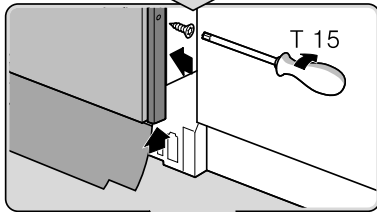
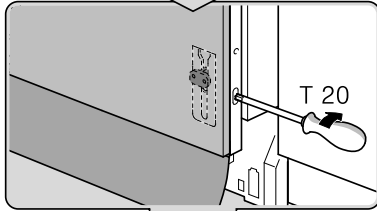
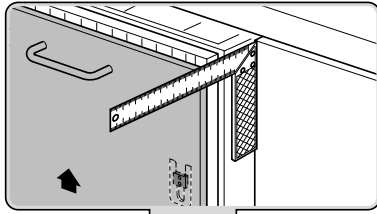

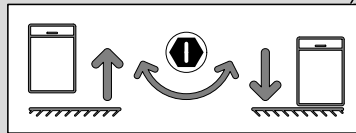
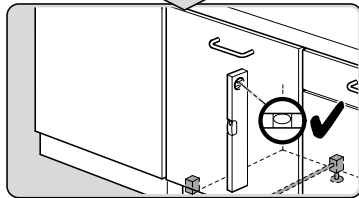
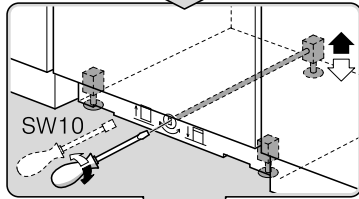
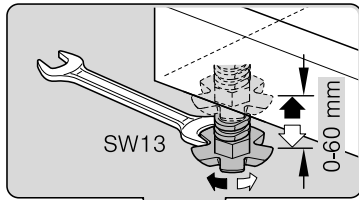

verspannen  
brace  
calar verticalement  
Enrasar

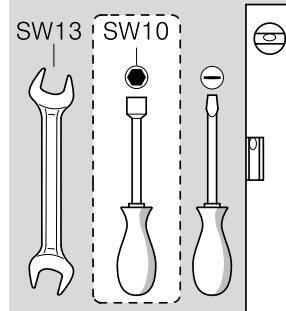
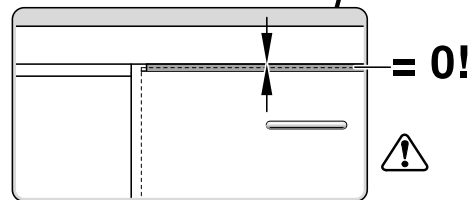





Ø4X30

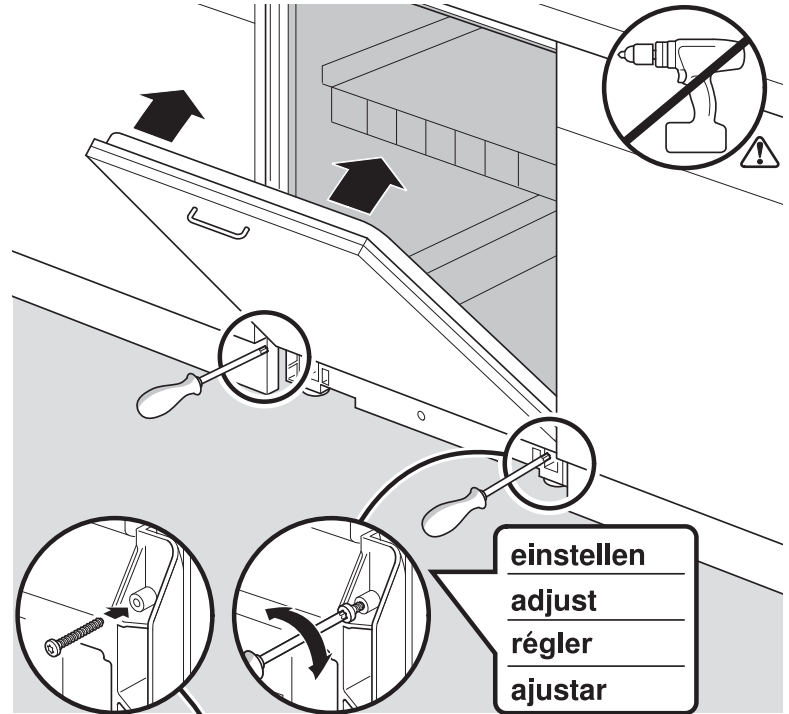
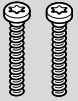

einstellen  
adjust  
régler  
ajustar

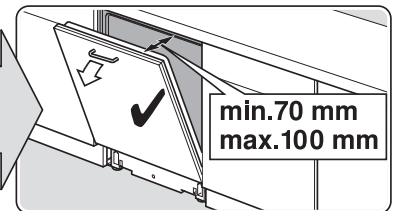
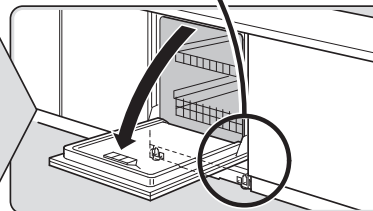
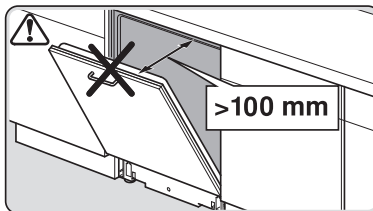
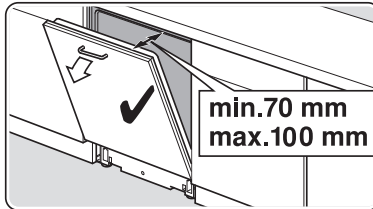

Torx  
T 20



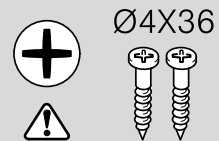
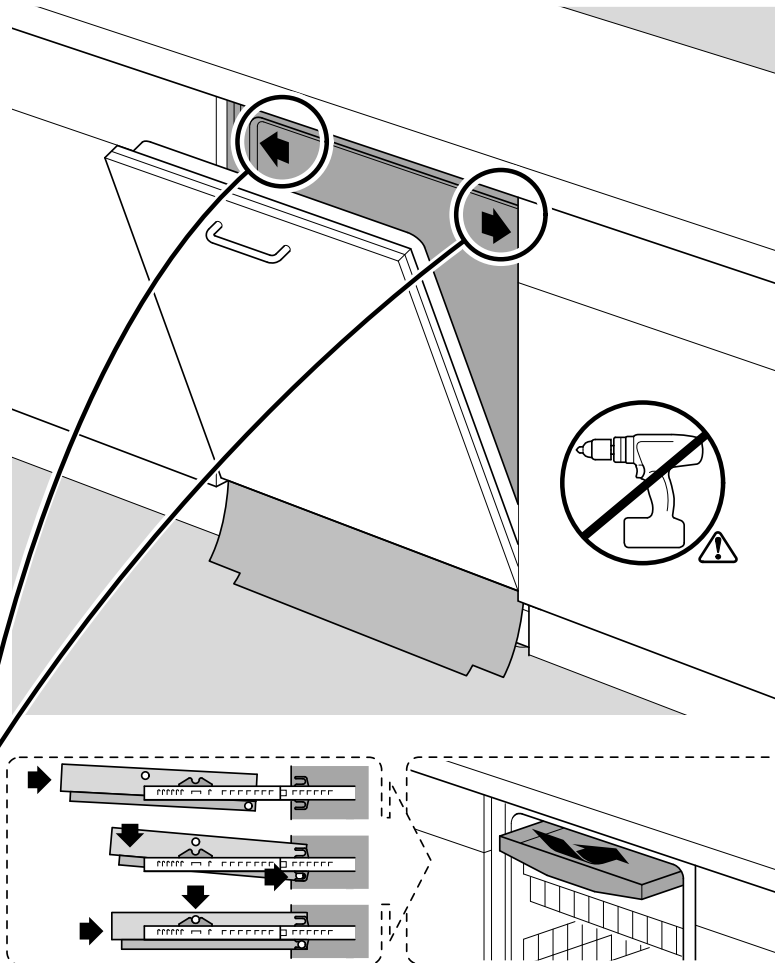
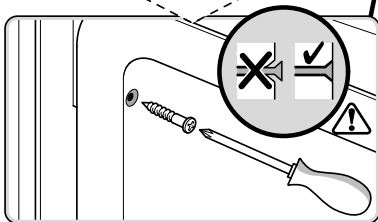
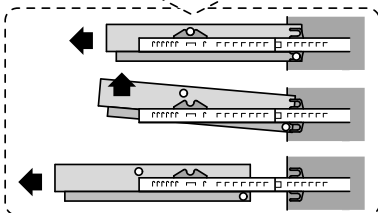
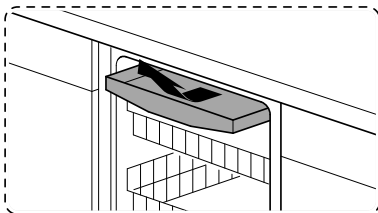
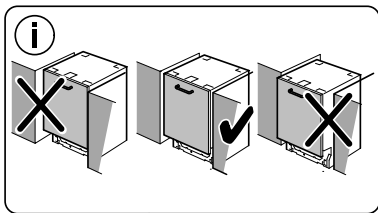

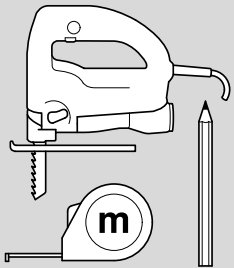
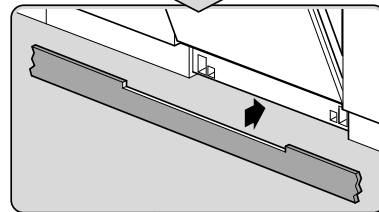
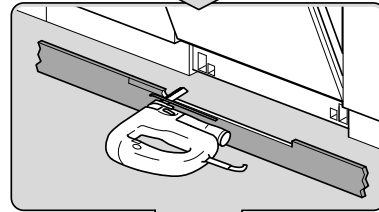
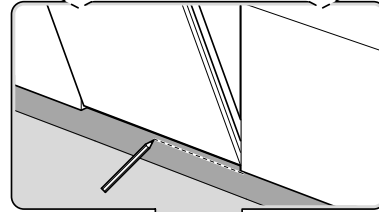
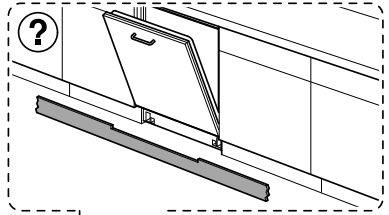
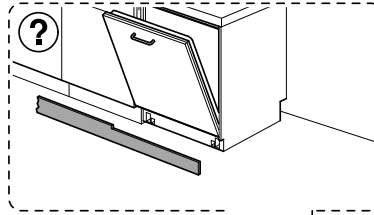
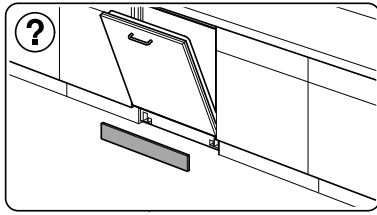

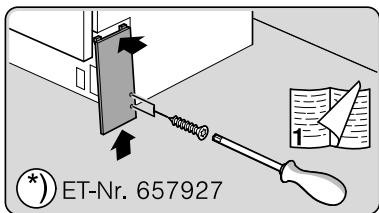
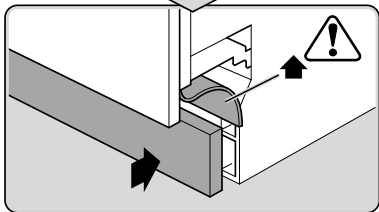
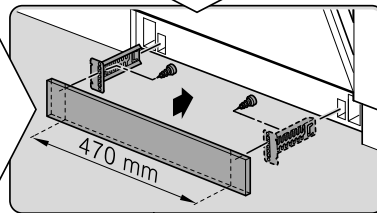
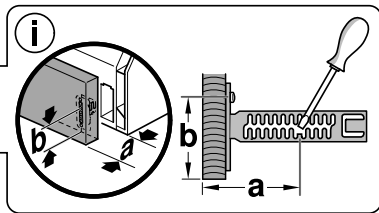
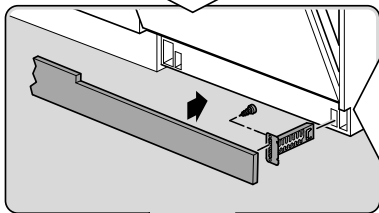
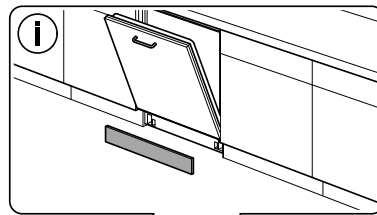
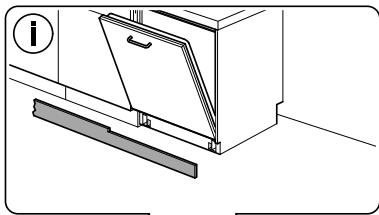

Ø4X15

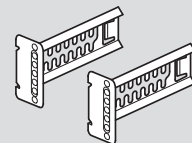

(\*) ET-Nr. 657927

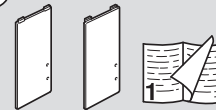

Torx  
T 20

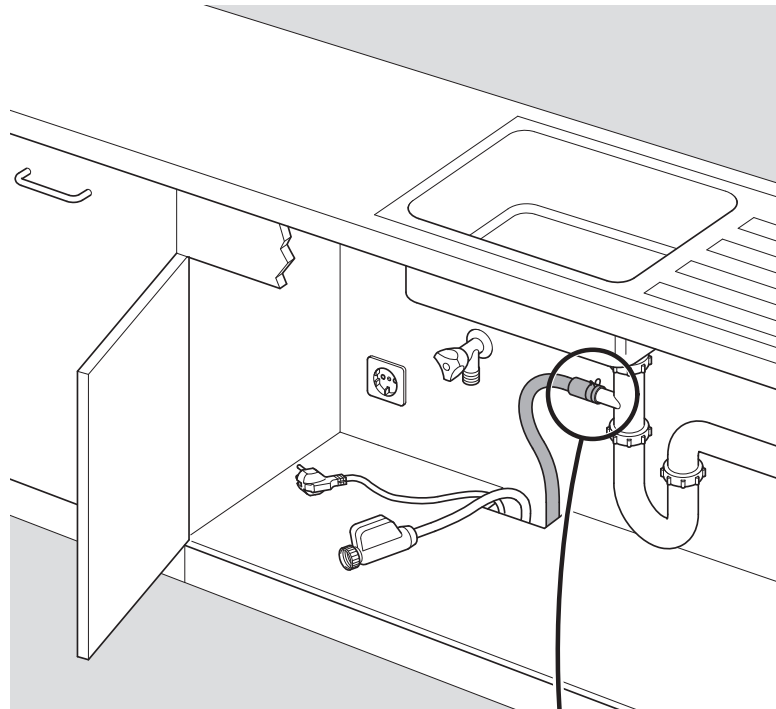
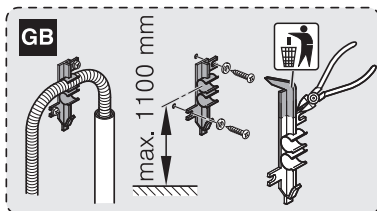
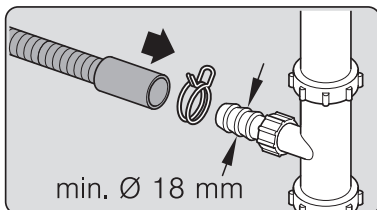
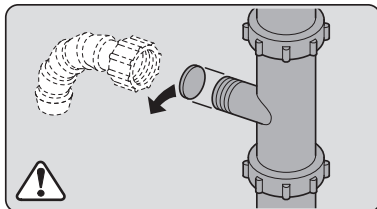
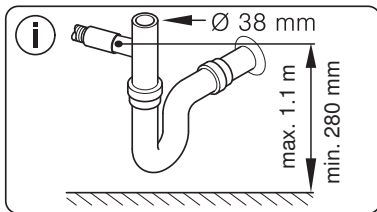

**Dichtheit prüfen**  
**Check for leaks**  
**Verifiez l'étanchéité**  
**Verificar la estanqueidad**

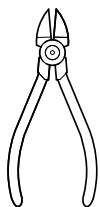
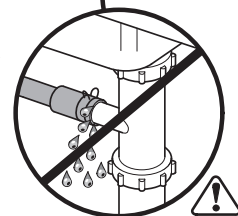

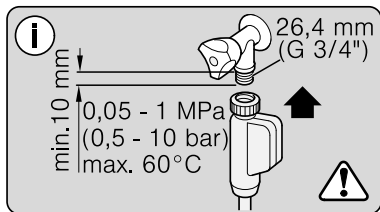

**max. 10 Nm**

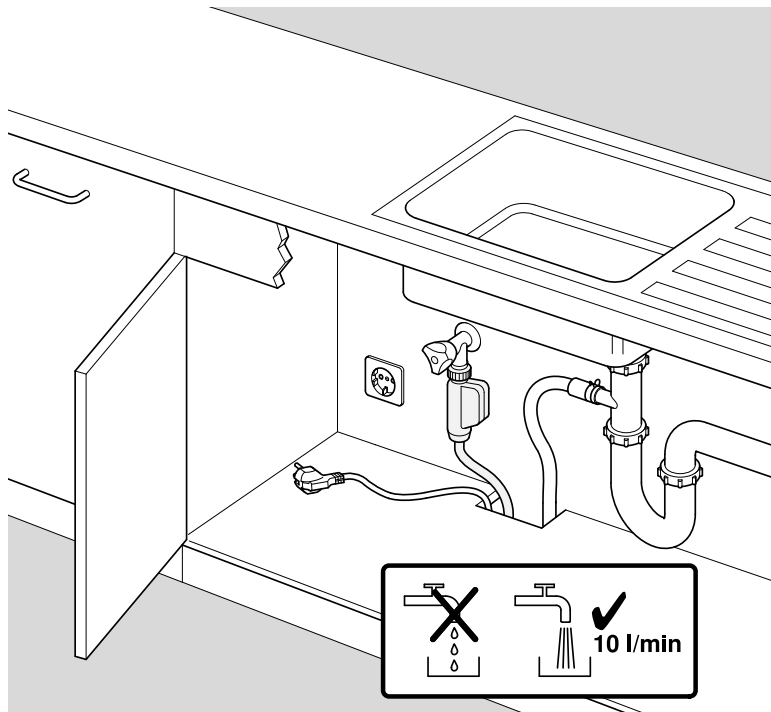

Dichtheit prüfen  
 Check for leaks  
 Verifiez l'étanchéité  
 Verificar la estanqueidad



