

**Gaggenau**

**en** Instruction Manual and Installation Instructions

# WM260162CN

Washing machine

## Your new washing machine

You have chosen a Gaggenau washing machine.

Please take a few minutes to read and become familiar with the advantages of your washing machine.

To meet the high quality demands required by Gaggenau, every washing machine that leaves our factory is carefully checked to ensure that it functions correctly and is in perfect condition.

For more information on our products, accessories, replacement parts and services, see our website [www.gaggenau.com](http://www.gaggenau.com) or contact our after-sales service centres.

If the operating and installation instructions describe different models, any differences will be pointed out at the relevant points in the text.



Read these operating and installation instructions before switching on the washing machine.

## Display rules

### **Warning!**

This combination of symbol and signal word indicates a possibly dangerous situation. Not heeding the warning can cause death or injuries.

### **Caution!**

This signal word indicates a possibly dangerous situation. Not heeding the caution can cause property and/or environmental damage.

### **Note/tip**

Information about the optimum use of the appliance/any other useful information.



### **1. 2. 3. / a) b) c)**

The steps are represented by numbers or letters.

■ / -

Lists are represented by a small box or a dash.

# Contents

 <b>Intended use</b> . . . . .	5	 <b>Detergent</b> . . . . .	30
 <b>Safety instructions</b> . . . . .	6	Correct selection of detergent . . . . .	30
Children/people/pets . . . . .	6	Saving energy and detergent . . . . .	30
Installation . . . . .	7	 <b>Overview of programmes</b> . . . . .	31
Operation . . . . .	10	Programmes on the programme selector . . . . .	31
Cleaning/Maintenance . . . . .	11	Starching . . . . .	37
 <b>Environmental protection</b> . . . . .	13	Dyeing/bleaching . . . . .	37
Packaging/used appliance . . . . .	13	 <b>Programme default settings</b> . . . . .	38
Tips on economical use . . . . .	14	Temperature . . . . .	38
 <b>Positioning and connecting</b> . . . . .	15	Spin Speed . . . . .	38
Included with the appliance . . . . .	15	Finished in . . . . .	38
Safety instructions . . . . .	16	i-DOS settings . . . . .	39
Installation surface . . . . .	16	 <b>Additional programme settings/options (* depending on the model)</b> . . . . .	40
Installation on a base or a wooden joist floor . . . . .	16	SpeedPerfect  . . . . .	40
Installation on a platform with drawer . . . . .	16	EcoPerfect  . . . . .	40
Installing the appliance in a kitchenette . . . . .	17	Prewash * . . . . .	40
Removing the transport locks . . . . .	17	Rinse plus * . . . . .	40
Hose and cable lengths . . . . .	18	Water plus * . . . . .	41
Water inlet . . . . .	19	Easy iron * . . . . .	41
Water outlet . . . . .	20	Soaking * . . . . .	41
Levelling . . . . .	21	Rinse hold * . . . . .	41
Electrical connection . . . . .	21	Silent Wash * . . . . .	41
Before washing for the first time . . . . .	22	Stains * . . . . .	42
Transportation . . . . .	23	 <b>Operating the appliance</b> . . . . .	43
 <b>Main points in brief</b> . . . . .	24	Preparing the washing machine . . . . .	43
 <b>Getting to know the appliance</b> . . . . .	25	Switching on the appliance/ selecting a programme . . . . .	43
Washing machine . . . . .	25	Change the programme default settings . . . . .	43
Control panel . . . . .	26	Select additional programme settings . . . . .	44
Display panel . . . . .	27	Placing laundry into the drum . . . . .	44
 <b>Laundry</b> . . . . .	29	Measure and add detergent and care products . . . . .	44
Prepare the laundry . . . . .	29	Start the programme . . . . .	45
Sorting laundry . . . . .	29	Child lock.  3 sec. . . . .	45
		Adding laundry . . . . .	46

Changing the programme . . . . . 46  
 Cancel the programme . . . . . 46  
 Programme end during rinse hold . . 46  
 Programme end . . . . . 46  
 Removing laundry/switching off the  
 appliance . . . . . 47

**i-DOS Intelligent dosing system. . . . 48**

Intelligent dosing system in the  
 detergent drawer . . . . . 48  
 Initial use/filling the dispensers . . . 48  
 Everyday use . . . . . 49  
 Base dosage . . . . . 50  
 Dispenser content for i-DOS  . . 50  
 Manual dosage . . . . . 51

** Appliance settings . . . . . 52**

** Sensors . . . . . 53**





Automatic load sensing . . . . . 53  
 Unbalanced load detection system . 53  
 AquaSensor . . . . . 53  
 Load sensor/display . . . . . 53  
 Dosing recommendation . . . . . 53

** Cleaning and maintenance . . . 54**

Machine housing/control panel . . . 54  
 Drum . . . . . 54  
 Descaling . . . . . 54  
 i-DOS detergent draw and its  
 housing . . . . . 55  
 The drain pump is blocked,  
 emergency draining . . . . . 56  
 The drain hose at the siphon is  
 blocked . . . . . 57  
 Filter in the water supply blocked . . 57

** Faults and what to do about  
 them. . . . . 58**

Emergency release . . . . . 58  
 Information on the display panel . . . 59  
 Faults and what to do about them. . 60

** After-sales service . . . . . 62**  
** Consumption rates . . . . . 63**  
** Technical data . . . . . 63**  
** Aqua-Stop warranty . . . . . 63**



## Intended use

- This appliance is intended for private domestic use only.
- Do not install or operate this appliance anywhere that is liable to experience frost and/or outdoor conditions. There is a risk that the appliance will be damaged if residual water in it freezes. If hoses freeze up, they may crack/burst.
- This appliance must only be used for washing domestic laundry, consisting of machine-washable items and hand-washable woollens (see label on item). Using the appliance for any other purpose is outside of the scope of its intended application and is forbidden.
- This appliance is suitable for operation with mains water and commercially available detergents and care products (must be suitable for use in washing machines).
- This appliance is intended for use up to a maximum height of 4000 metres above sea level.

### **Before you switch on the appliance:**

Check that there is no visible damage to the appliance. Do not operate the appliance if it is damaged. Should you have any problems, please contact your specialist dealer or our customer service.

Read and follow the operating and installation instructions and all other information provided with this appliance.

Retain the documents for subsequent use or for subsequent owners.

## Safety instructions

The following safety information and warnings are provided to protect you from injury and to prevent material damage to your surroundings.

It is nevertheless important to take the necessary precautions and to proceed with care when installing, maintaining, cleaning and operating the appliance.

### Children/people/pets

#### **Warning** **Risk of death!**

Children and other people who are unable to assess the risks involved when using the appliance may injure themselves or may find themselves in life-threatening situations. Therefore please note:

- The appliance may be used by children over the age of 8 years and by persons with reduced physical, sensory or mental capacity or by persons with a lack of experience or knowledge as long as they are supervised or have received instruction on how to use the appliance safely and they have understood the potential risks of using the appliance.
- Children must not play with this appliance.

- Do not allow children to clean or maintain this appliance unsupervised.
- Keep children under 3 years and pets away from this appliance.
- Do not leave the appliance unattended when children or other people who are unable to assess the risks are in the vicinity.

#### **Warning** **Risk of death!**

Children may lock themselves inside appliances and find themselves in a life-threatening situation.

- Do not position the appliance behind a door, as this may obstruct the appliance door or prevent it from opening completely.
- Once an appliance has reached the end of its life, pull the mains plug from the socket **before** severing the mains cable, and then destroy the lock on the appliance door.

**⚠ Warning****Risk of suffocation!**

If allowed to play with the packaging/plastic film or packing components, children may become caught in these or pull them over their heads and suffocate.

Keep packaging, plastic film and packing components away from children.

**⚠ Warning****Risk of poisoning!**

Detergents and care products may result in poisoning if consumed.

If accidentally swallowed, seek medical advice. Keep detergents and care products out of the reach of children.

**⚠ Warning****Risk of burns!**

When washing at high temperatures, the glass in the appliance door becomes hot. Stop children from touching the appliance door when it is hot.

**⚠ Warning****Eye/skin irritation!**

Contact with detergents or care products may cause eye/skin irritation.

Rinse eyes/skin thoroughly if they/it come(s) into contact with detergents or care products. Keep detergents and care products out of the reach of children.

**Installation****⚠ Warning****Risk of electric shock/fire/material damage/damage to the appliance!**

If the appliance is not installed properly, this may lead to a dangerous situation. Ensure the following:

- The mains voltage on your power socket must match the rated voltage specified on the appliance (identification plate). The connected loads and the required fuse protection are specified on the identification plate.
- The mains plug and the protective contact socket must match and the earthing system must be correctly installed.
- The installation must have an adequate cross section.
- The mains plug must be freely accessible at all times. If this is not possible, in order to comply with the relevant safety regulations, a switch (all pole disconnection) must be built into the permanent installation in accordance with electrical installation regulations.

- If using a residual current circuit breaker, only use one that bears the following mark: . The presence of this mark is the only way to be sure that it fulfils all the applicable regulations.

** Warning**  
**Risk of electric shock/fire/  
material damage/damage to  
the appliance!**

If the appliance's mains cable is altered or damaged, this may result in electric shock, short circuiting or fire due to overheating.

The mains cable must not be kinked, crushed or altered, and must not come into contact with any heat sources.

** Warning**  
**Risk of fire/material damage/  
damage to the appliance!**

The use of extension cords or power strips may result in fire due to overheating or short circuiting.

Connect the appliance directly to an earthed socket that has been correctly installed. Do not use extension cords, power strips or multi-way couplers.

** Warning**  
**Risk of injury/material  
damage/damage to the  
appliance!**

- The appliance may vibrate or move when in operation, potentially resulting in injury or material damage. Place the appliance on a clean, even, solid surface and, using a spirit level to guide you, level it with the screw-in feet.
- If you take hold of any of the appliance's protruding parts (e.g. the appliance door) in order to lift or move it, these parts may break off and cause injury. Do not take hold of any of the appliance's protruding parts in order to move the appliance.



**⚠ Warning****Risk of injury!**

- The appliance is very heavy. Lifting it may result in injury. Do not lift the appliance on your own.
- The appliance has sharp edges on which you could cut your hands. Do not take hold of the appliance by its sharp edges. Wear protective gloves to lift it.
- If the hoses and mains cables are not correctly routed, they may constitute a tripping hazard, which may result in injury. Route hoses and cables such that they do not constitute a tripping hazard.

**Caution!****Material damage/damage to the appliance**

- If the water pressure is too high or too low, the appliance may not be able to operate properly, and it may also result in material damage or damage to the appliance. Make sure that the water pressure in the water supply facility is at least 100 kPa (1 bar), and does not exceed 1000 kPa (10 bar).

- If the water hoses are altered or damaged, this may result in material damage or damage to the appliance. The water hoses must not be kinked, crushed, altered or severed.
- The use of hoses supplied by other brands to connect to the water supply may result in material damage or damage to the appliance. Use the hoses supplied with the appliance or genuine spare part hoses only.
- The appliance is secured for transportation by transport locking devices. If the transport locking devices are not removed before the appliance is operated, this may result in damage to the appliance. It is important to completely remove all transport locking devices before using the appliance for the first time. Make sure that you retain these transport locking devices separately. It is important to refit the transport locking devices if the appliance is to be transported, in order to prevent the appliance from being damaged in transit.

## Operation

### **Warning**

#### **Risk of explosions/fire!**

Laundry that has been pretreated with cleaning agents that contain solvents, e.g. stain remover/cleaning solvent, may cause an explosion in the drum. Rinse the laundry thoroughly with water before washing it in the machine.

### **Warning**

#### **Risk of poisoning!**

Poisonous fumes may be given off by cleaning agents that contain solvents, e.g. cleaning solvent.

Do not use cleaning agents that contain solvents.

### **Warning**

#### **Risk of injury!**

- If you support your weight/sit on the appliance door when it is open, the appliance may tip over, which may result in injury.

Do not support your weight on the appliance door when it is open.

- If you climb onto the appliance, the worktop may break, which may result in injury.

Do not climb onto the appliance.

- If you reach into the drum while it is still rotating, you risk injuring your hands. Wait until the drum has stopped rotating.

### **Warning**

#### **Risk of scalding!**

When washing at high temperatures, there is a risk of scalding if you come into contact with hot detergent solution (e.g. when draining hot detergent solution into a washbasin).

Do not reach into the hot detergent solution.

### **Warning**

#### **Eye/skin irritation!**

Detergent and care products may spray out if the detergent drawer is opened while the appliance is in operation.

Rinse eyes/skin thoroughly if they/it come(s) into contact with detergents or care products. If accidentally swallowed, seek medical advice.

**Caution!****Material damage/damage to the appliance**

- If the amount of laundry in the appliance exceeds its maximum load capacity, it may not be able to operate properly, or this may result in material damage or damage to the appliance.  
Do not exceed the maximum load capacity of dry laundry. Make sure you comply with the maximum load capacities specified for each of the programs. → *Page 31*
- If you pour the wrong quantity of detergent or cleaning agent into the appliance, this may result in material damage or damage to the appliance.  
Use detergents/care products/cleaning agents and softeners in accordance with the manufacturers' instructions.

**Cleaning/Maintenance**** Warning  
Risk of death!**

The appliance is powered by electricity. There is a risk of electric shock if you come into contact with live components. Therefore please note:

- Switch off the appliance. Disconnect the appliance from the power supply (pull out the plug).

- Never take hold of the mains plug with wet hands.
- When removing the mains plug from the socket, always take hold of the plug itself and never the mains cable, otherwise this may damage the mains cable.
- Do not make any technical modifications to the appliance or its features.
- Repairs and any other work on the appliance must only be conducted by our customer service or by an electrician. The same applies for replacing the mains cable (when necessary).
- Spare mains cables can be ordered from our customer service.

** Warning  
Risk of poisoning!**

Poisonous fumes may be given off by cleaning agents that contain solvents, e.g. cleaning solvent.  
Do not use cleaning agents that contain solvents.

** Warning  
Risk of electric shock/material damage/damage to the appliance!**

If moisture penetrates the appliance, this may cause it to short circuit.  
Do not use a pressure washer, steam cleaner, hose or spray gun to clean your appliance.

 **Warning**

**Risk of injury/material damage/damage to the appliance!**

The use of spare parts and accessories supplied by other brands is dangerous and may result in injury, material damage or damage to the appliance.

For safety reasons, use genuine spare parts and accessories only.

**Caution!**

**Material damage/damage to the appliance**

Cleaning agents and agents for pretreating laundry (e.g. stain removers, prewash sprays, etc.) may cause damage if they come into contact with the surfaces of the appliance.

Therefore please note:

- Do not allow these agents to come into contact with the surfaces of the appliance.
- Clean the appliance with nothing but water and a soft, damp cloth.
- Remove any detergent, spray or other residues immediately.



## Environmental protection

### Packaging/used appliance

Dispose of packaging in an environmentally-responsible manner.

Keep children away from the packaging materials and packaging materials are not toys.

Reprocessing and reuse of packaging material saves raw materials, reducing waste. All packaging materials used are in line with environmental protection requirements and reusable.

### Name and content of hazardous substances in products

Component name	Hazardous substance					
	Lead (Pb)	Mercury (Hg)	Cadmium (Cd)	Hexavalent chromium (Cr(VI))	Polybrominated biphenyls (PBB)	Polybrominated diphenyl ethers (PBDE)
PCB	x	o	o	o	o	o
Display	x	o	o	o	o	o
Controller	x	o	o	o	o	o
Power cord and connect wiring harness	x	o	o	o	o	o
Pumps and drives	x	o	o	o	o	o
Housing	o	o	o	o	o	o
Door and its constituent parts	x	o	o	o	o	o
Drum-system and its constituent parts	x	o	o	o	o	o
Water supply components (exempted dryer)	x	o	o	o	o	o

This table was developed according to the provisions of SJ/T 11364.

- o The content of such hazardous substance in all homogeneous materials of such component is below the limit required by GB/T 26572.
- x The content of such hazardous substance in a certain homogeneous materials of such component is beyond the limit required by GB/T 26572.



**Note:** All of component parts in the BSH products that fall into the same category are covered in the table above, the component parts of this product depend on the actual situation. If you have any questions, please contact us by dialling the customer service number in the product.

### Indicative Statement of Environment Protection of Product

Please use and maintain the product according to the instruction of the manual, the product may harm to environment and human health due to improper utilization or disposal.

According to the law of 'Statute of Recovery and Disposal of Waste Electrical and Electronic Products', Please hand in the products to the disposal enterprises which are qualified when you plan to throw it. Please refer to the table above for the information about the content of relevant toxic and hazardous substances.

### Tips on economical use

- Always fill the appliance with the maximum amount of laundry for each programme.  
→  *Overview of programmes" on page 31*
  - Wash normally soiled laundry without prewash.
  - For light and normal soiling in laundry, you can save energy and detergent. → *Page 30*
  - Dosing the detergent using the **intelligent dosing system** (i-DOS) helps to save both detergent and water.
  - The selectable temperatures apply to the care labels on the textiles. The temperatures in the machine may deviate from this so that you get the optimum mix of energy-saving and washing results.
  - **Energy-saving mode:** The display panel lighting goes out after a few minutes and the  button flashes. Press any button to activate the lighting.  
Energy-saving mode is not activated if a programme is running.
  - **Automatic switch off:** If the appliance is not operated for a prolonged period, it may automatically switch off before the programme starts and when the programme has ended to save energy. Press the main switch again to switch on the appliance.  
→  *Appliance settings" on page 52*
- If the washing will be dried in a dryer, select the spin speed according to the dryer manufacturer's instructions.

## Positioning and connecting

### Included with the appliance

**Note:** Check the machine for transport damage. Never use a damaged machine. If you have any complaints, contact the dealer from whom you purchased the appliance or our customer services. → Page 62

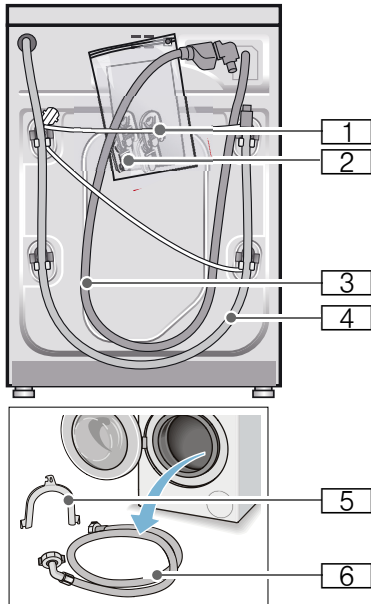

- 1 Mains cable
  - 2 Bag:
    - Installation and operating instructions
    - Customer services location directory\*
    - Warranty\*
    - Cover caps for openings after the transport braces have been removed
    - Adaptor with sealing washer from 21 mm = 1/2" to 26.4 mm = 3/4" \*
  - 3 Water supply hose on Aqua-Stop models
  - 4 Water drain hose
  - 5 Elbow for securing the water drain hose\*
  - 6 Water supply hose on standard/Aqua-Secure models
- \* depending on the model

**In addition**, a hose clamp (24 - 40 mm diameter, available from specialist dealers) is required to connect the water drain hose to a siphon.

### Useful tools

- Spirit level for aligning
- Spanner with:
  - WAF13 for loosening the transport braces, and
  - WAF17 for aligning the appliance feet

## Safety instructions

### **Warning** **Risk of injury!**

- The washing machine is very heavy. Be careful when lifting/transporting the washing machine.
- When the washing machine is lifted by its protruding parts (e.g. the washing machine door), the components may break off and cause injuries. Do not lift the washing machine by protruding parts.
- If the hose and mains cables are not routed properly, there is a risk of tripping and injury. Lay hoses and cables in such a way that there is no risk of tripping.

### **Caution!**

#### **Damage to the appliance**

Frozen hoses may rip/burst. Do not install the washing machine in areas exposed to frost or outdoors.

### **Caution!**

#### **Water damage**

The connection points for the water supply hose and water drain hose are under high water pressure. To prevent leaks and water damage, you must follow the instructions in this section.

### **Notes**

- In addition to the safety information listed here, the local water and electricity supplier may have special requirements.
- If in doubt, have the appliance connected by a specialist.

## Installation surface

**Note:** The washing machine be stable so that it does not move around.

- The installation surface must be firm and level.
- Soft floors/floor coverings are not suitable.

## Installation on a base or a wooden joist floor

### **Caution!**

#### **Damage to the appliance**

The washing machine may "wander" and tip/topple from the base when spinning.

The feet of the appliance must be secured with holding brackets.

Order no. WMZ 2200, WX 9756, Z 7080X0

**Note:** On wooden joist floors, install the washing machine:

- In a corner, if possible,
- On a water-resistant wooden board (min. 30 mm thick) which is screwed tightly to the floor.

## Installation on a platform with drawer

Platform order no.: WMZ 20490, WZ 20490, WZ 20510, WZ 20520



## Installing the appliance in a kitchenette

### **⚠ Warning** **Danger of death!**

There is a risk of electric shock if you touch live components.  
Do not remove the appliance covering plate.

### Notes

- Recess width of 60 cm required.
- Only install the washing machine underneath a continuous worktop that is securely connected to adjacent cabinets.

## Removing the transport locks

### **Caution!** **Damage to the appliance**

- The machine is secured for transportation using transport locks. If the transport locks are not removed, the drum, for example, may become damaged when the machine is operated. Before using the appliance for the first time, make sure that you completely remove all four transport locks. Keep the locks in a safe place.
- To prevent transport damage from occurring if the appliance is moved at a later date, you must refit the transport locks before transporting the appliance.

**Note:** Keep the screws and sleeves in a safe place.

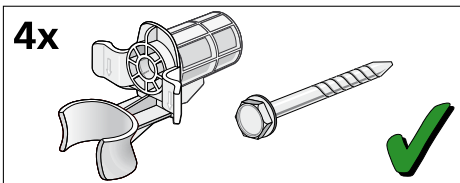

1. Take the hoses out of the holders.

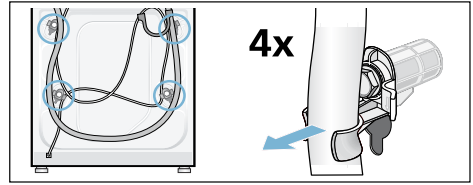

2. Unscrew and remove all four transportation securing bolts with a wrench (WAF 13). Remove the sleeves. Remove the mains cable from the holders.

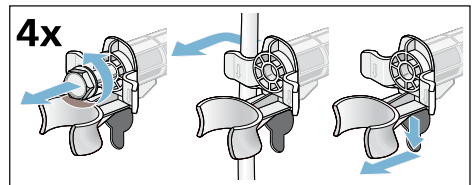

3. Insert the covers. Lock the covers firmly in place by applying pressure to the snap-in hooks.

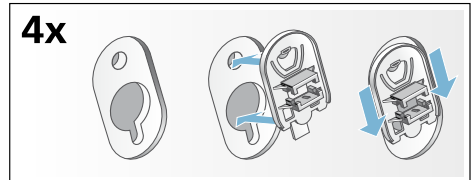

## Hose and cable lengths

### ■ Left-hand connection

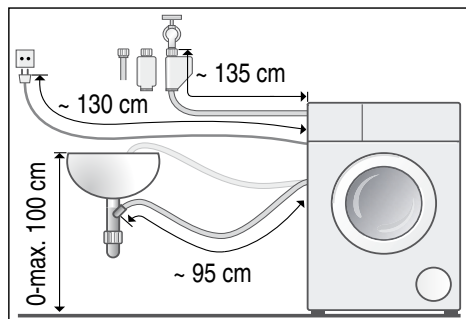

### ■ Right-hand connection

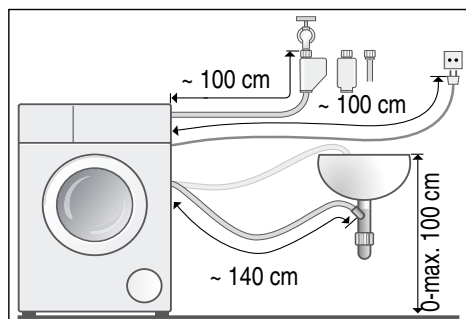

**Tip:** The following are available from specialist dealers/customer services:

- Extension for Aqua-Stop and cold water supply hose (approx. 2.50 m); order no. WM Z2380, WZ 10130, CZ 11350, Z 7070X0
- A longer supply hose (approx. 2.20 m) for standard models; individual component number for customer services: 00353925

## Water inlet

### **Warning** **Danger of death!**

There is a risk of electric shock if you touch live components.

Do not immerse the Aqua-Stop safety valve in water (it contains an electric valve).

### Notes

- Only operate the washing machine using cold mains water.
- Do not connect the machine to the mixer tap of an unpressurised hot-water boiler.
- Do not use a used supply hose. Only use the supply hose supplied or one that was purchased from an authorised specialist retailer.
- Do not kink or squash the water supply hose.
- Do not alter (shorten, cut through) the water supply hose (otherwise its strength is no longer guaranteed).
- Only tighten the screw connections by hand. If the screw connections are tightened too much with a tool (pliers), the thread may become damaged.
- When connecting to a 21 mm = 1/2" tap, first fit an adapter\* with a sealing washer from 21 mm = 1/2" to 26.4 mm = 3/4".  
\*supplied depending on the model

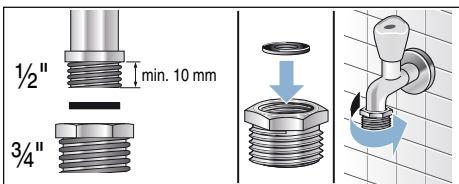

### Optimum water pressure in the supply network

**At least** 100 kPa (1 bar)

**Maximum** 1000 kPa (10 bar)

When the tap is open, the water flow rate is at least 8 l/min.

If the water pressure is higher than this, a pressure-reducing valve must be installed.

### Connection

Connect the water supply hose to the tap (26.4 mm = 3/4") and to the appliance (not necessary for Aqua-Stop models as this is permanently installed):

#### ■ Model: **Standard**

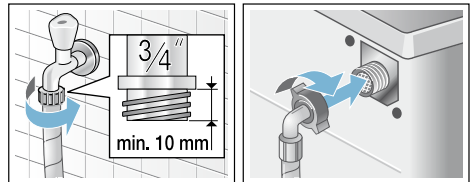

#### ■ Model: **Aqua-Secure**

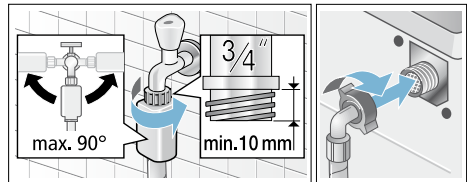

#### ■ Model: **Aqua-Stop**

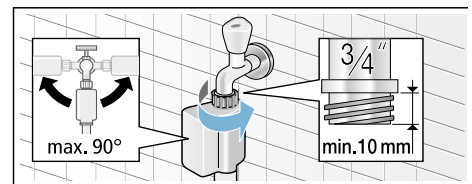

**Note:** Turn on the tap carefully, checking the leak tightness of the connection points. The screw connection is under mains water pressure.

## Water outlet

### **Warning** **Risk of scalding!**

When you are washing at high temperatures, there is a risk of scalding if you come into contact with hot water (e.g. when draining hot water into a washbasin).

Do not reach into the hot water.

### **Caution!** **Water damage**

If the drain hose slips out of the washbasin or the connection point during draining due to high water pressure, any escaping water may cause water damage.

Secure the drain hose so that it cannot slip out.

### **Caution!** **Damage to the appliance/fabrics**

If the end of the drain hose is immersed in the drained water, water may be sucked back into the appliance and may damage the appliance/fabrics. Make sure that:

- The plug does not block drainage from the washbasin.
- The end of the drain hose is not immersed in the drained water.
- The water drains away quickly enough.

**Note:** Do not kink the water drain hose or put strain on it lengthways.

## Connection

### ■ **Drainage into a washbasin**

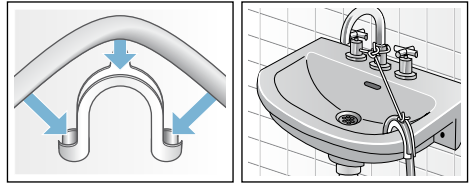

### ■ **Drainage into a siphon**

The connection point must be secured using a hose clamp with a diameter of 24 - 40 mm (available from specialist dealers).

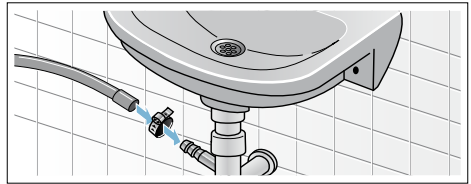

### ■ **Drainage into a plastic pipe with rubber bushing or into a drainage pit**

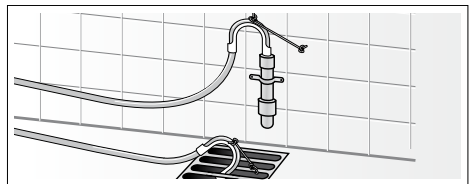

## Levelling

Align the appliance using a spirit level. Incorrect alignment may result in loud noises, vibrations and machine "movement".

1. Loosen the lock nuts using a WAF17 spanner, by turning it in a clockwise direction.
2. Check the alignment of the washing machine with a spirit level, and adjust it if necessary. Change the height by turning the appliance feet. All four appliance feet must stand firmly on the ground.
3. The lock nuts on all four appliance feet must be screwed tightly against the housing using a suitable WAF17 spanner. In doing so, hold the foot tight and do not adjust its height.



## Electrical connection

### **⚠ Warning** **Danger of death!**

There is a risk of electric shock if you touch live components.

- Never touch or hold the mains plug with wet hands.
- Only pull out the mains cable by the plug and never by the cable, as this could damage it.
- Never unplug the mains plug during operation.

Observe the following information and ensure that:

### Notes

- The mains voltage and voltage indicated on the washing machine (rating plate) are the same. The connected load and fuse required are specified on the rating plate.
- The washing machine is only connected to an alternating current supply via a properly installed earthed socket.
- The mains plug fits the socket.
- The cable cross-section is adequate.
- The earthing system is properly installed.
- The mains cable is only replaced by a qualified electrician (if this is necessary). Replacement mains cables are available from customer services.
- No multiple plugs/couplings or extension cables are used.
- If an earth-leakage circuit breaker is used, only a type which displays the  symbol is used. Only this symbol guarantees compliance with the currently applicable regulations.
- The mains plug can be accessed at all times. If this is not possible, in order to comply with the relevant safety regulations, a switch (2-pole switch-off) must be built into the permanent installation in accordance with electrical installation regulations.
- The mains cable is not kinked, squashed, altered or cut through.
- The mains cable does not come into contact with heat sources.



## Before washing for the first time

The washing machine was thoroughly tested before leaving the factory. To remove any water that may be left over from the test, run the first wash cycle **without** any laundry.





### Notes

- The washing machine **must be correctly installed and connected.** (from → *Page 15*)
- Never use a damaged machine. Inform the after-sales service.

### Preparatory work:

1. Check the machine.
2. Fill the dispenser  and . → *Page 48*
3. Remove the protective film from the control panel.
4. Plug into the mains.
5. Turn on the tap.

### Run the programme without laundry:

1. Switch on the appliance.
2. Close the door (do not load any laundry).
3. Set the **Drum clean 90 °C** programme.
4. Open the detergent drawer.
5. Pour approx. 1 litre of water into compartment  .
6. Pour standard washing powder into compartment  . **Note:** To prevent foaming, only use half of the amount of detergent recommended by the detergent manufacturer. Do not use detergents that are intended for wool or delicates.
7. Close the detergent drawer.
8. Press the  button.
9. Switch off the appliance at the end of the programme.

**Your washing machine is now ready to use.**

## Transportation

E.g. when moving house

### Caution!

**Risk of damage to the appliance caused by detergent/fabric softener leaking from the dispensers.**

Leaking detergent/fabric softener can prevent the appliance from working correctly, e.g. due to damage to the electronics.

Empty the dispensers before transporting the appliance.

### Preparatory work:

1. Turn off the tap.
2. Reduce the water pressure in the supply hose: → *Page 57*; cleaning and maintenance – filter in the water supply clogged
3. Disconnect the washing machine from the mains.
4. Drain any residual water: → *Page 56*; cleaning and maintenance – drain pump blocked, emergency draining
5. Remove the hoses.
6. Empty the dispensers. → *Page 55*

### Fitting the transportation securing means:

1. Remove the covers and keep them in a safe place.  
If required, use a screwdriver.

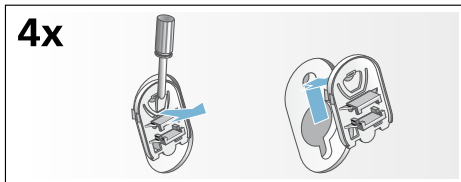

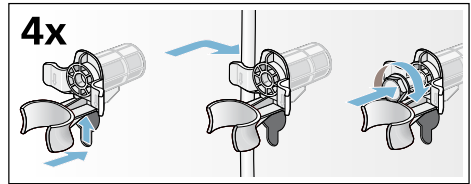

2. Insert all four sleeves.  
Clip the mains cable securely in the holders. Insert the transportation securing bolts and tighten them with a wrench (WAF 13).



**Before switching on the appliance again:**

### Notes

- **Always** remove the transport braces.
- To prevent unused detergent from flowing straight into the drain during the next wash: Pour approx. 1 litre of water into compartment   and start the **Drain** programme.

## Main points in brief

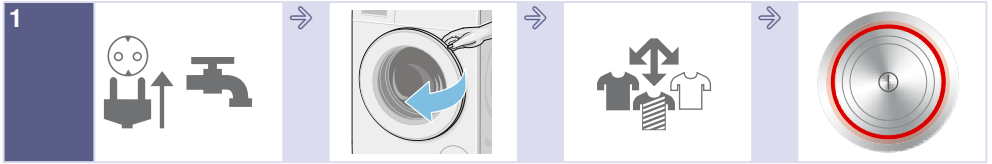

Plug into the mains.  
Turn on the tap.

Open the washing machine door.

Sort the laundry.

To switch on, press the  button.

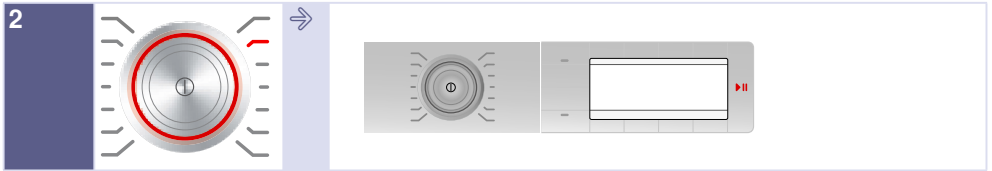

Select a programme, e.g. **Synthetics**.

If required, change the programme settings of the selected programme and select programme settings/options.

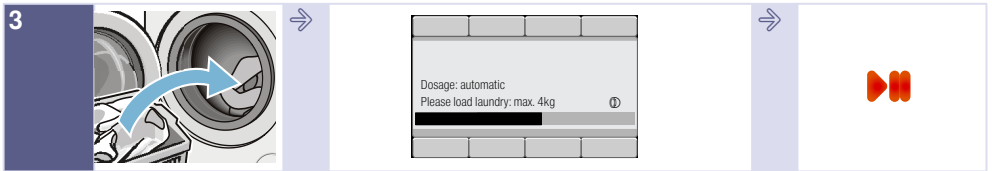

Load the drum.

Observe the maximum load (depending on the model) on the display panel.

Start the programme.

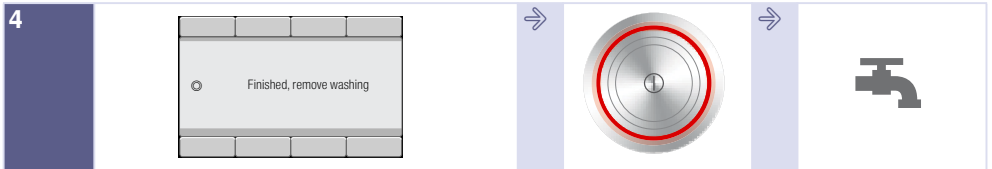

Programme end

To switch off, press the  button.

Turn off the tap (for models without Aqua-Stop).



# Getting to know the appliance

## Washing machine

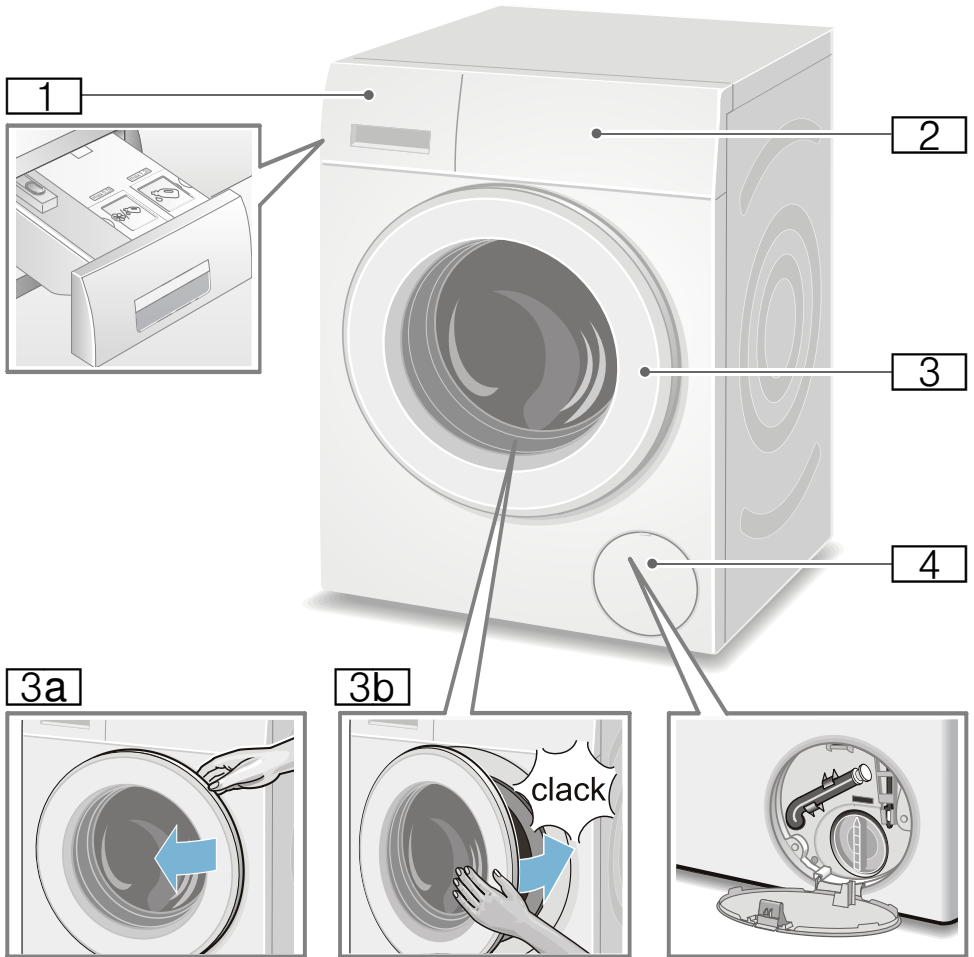

**1** Detergent drawer with illuminated displays for the i-DOS dispenser on the drawer handle → *Page 48*

**4** Service flap

**2** Operating/display panel

**3** Loading door with door handle

**3a** Open the loading door

**3b** Close the loading door

## Control panel

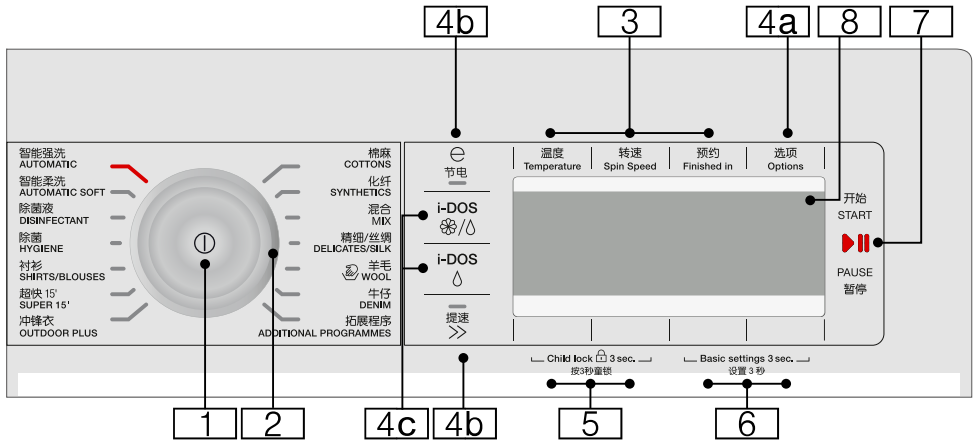

**Note:** All the buttons are sensitive (except for the main switch) and only need to be pressed lightly.

- 1** **Main switch**  
for switching the washing machine on and off:  
Press the ① button.
- 2** **Programme selector**  
for selecting a programme.  
The programme selector can be turned in either direction.  
Overview of programmes  
→ Page 31
- 3** **Buttons for changing the programme default settings:**  
→ Page 38
  - Temperature,
  - Spin Speed,
  - Finished in
- 4** **Buttons for selecting additional programme settings:**
- 4a** Options → Page 28,  
→ Page 40
- 4b** EcoPerfect (⊖),  
SpeedPerfect (⏩),
- 4c** i-DOS ⊕, i-DOS ⊖  
→ Page 39,  
An overview of all settings that can be selected → Page 31
- 5** Buttons **Child lock** 3 sec. for activating/deactivating the childproof lock → Page 45
- 6** Buttons **Basic settings 3 sec.** for changing the appliance settings, e.g. button signals, an overview of all selectable settings that can be selected → Page 28, → Page 52
- 7** **button for:**
  - Starting a programme,
  - Interrupting a programme, e.g. to add items of laundry → Page 46,
  - Cancelling a programme
- 8** **Display panel** for settings and information

## Display panel

### Main menu after selecting the programme

e.g. **Synthetics**

The arrows on the display panel indicate in which direction the programme default settings can be changed using the buttons located above and below.

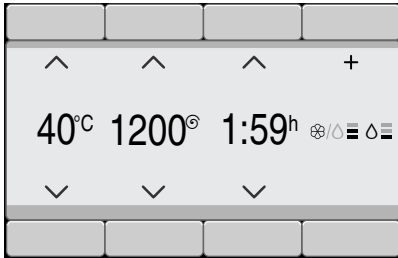

### Additional programmes Programmes selected

and select, for example, the **Spin** programme:

Using the buttons below the arrows, you can select the required programme. The selection is acknowledged by a tick.

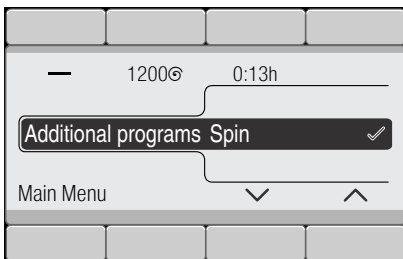

Wait or go back by pressing the **Main menu** button; the selected programme is displayed on the display panel.

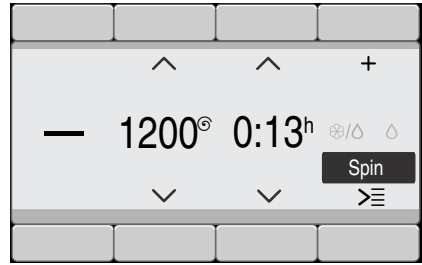

To change, select the button under the programme highlighted in black and change the programme.

### Selecting the dosage strength using the i-DOS button

for example, select the **i-DOS** button and **medium** dosage strength:

Using the buttons below the arrows, you can select the required dosage strength for the detergent. The selection is acknowledged by a tick.

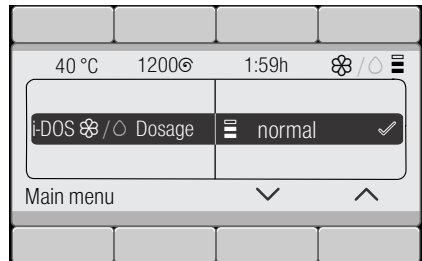

Wait or go back to the main menu by pressing the **Main menu** or **i-DOS** button.

**en** Getting to know the appliance

### Options button selected

and select, for example, the **Rinse hold** (☐) option:

Using the buttons under the two left-hand arrows, select the option. Using the two right-hand arrows, select the displayed value. The selected options are active immediately and are displayed on the display panel.



Wait or go back to the main menu by pressing the **Options** button.

### Basic settings 3 sec. buttons selected

Change the appliance setting: e.g. volume of the **end signal** → *Page 52*

Using the buttons under the two left-hand arrows, select the setting. Using the two right-hand arrows, select the displayed value. The selection is acknowledged by a tick.

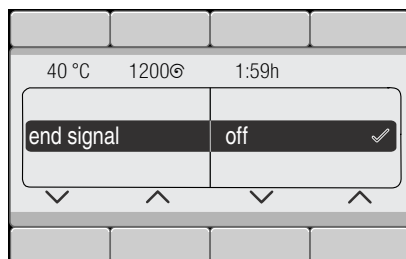

Wait or go back to the main menu by pressing the **Basic settings 3 sec.** (press and hold again).



## Laundry

### Prepare the laundry

#### Caution!

#### Damage to the appliance/fabrics

Foreign objects (e.g. coins, paperclips, needles, nails) may damage the laundry or components in the washing machine.

You should therefore note the following tips when preparing your laundry:

- Empty any pockets.

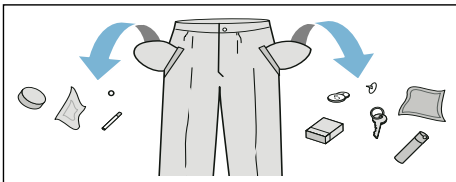

- Look out for metal items (paperclips, etc.) and remove them.
- Wash delicates in a laundry bag (tights, underwired bras, etc.).
- Close any zips; button up any cover buttons.
- Brush sand out of pockets and collars.
- Remove curtain fittings or place curtains in a laundry bag.

### Sorting laundry

Sort your laundry according to the care instructions and manufacturer's information on the care labels, depending on:







- Type of fabric/fibre
- Colour
  - Note:** Laundry may discolour. Wash white and coloured items separately. Wash new coloured items separately the first time you wash them.
- Soiling
  - Wash laundry with the same level of soiling together.

Some examples of soiling levels can be found on → *Page 30*

- **Light:** Do not prewash, select the **SpeedPerfect**  setting if necessary
- **Normal**
- **Heavy:** Load less laundry, select a programme with prewash
- **Stains:** Remove/pretreat stains while they are fresh. Firstly, dab with soapy water; do not rub. Then wash the items of laundry with the appropriate programme. Stubborn or dried-in stains can sometimes only be removed by washing several times.

- Symbols on the care labels

**Note:** The numbers in the symbols indicate the maximum washing temperature that may be used.

-  Suitable for normal washing process; e.g. Cottons programme
-  A gentle washing process is required; e.g. Easy-Care programme
-  An especially gentle washing process is required; e.g. Delicate/Silk programme
-  Suitable for washing by hand; e.g.  Woollens programme
-  Do not machine wash.

## Detergent

### Correct selection of detergent

The care label is crucial for selecting the correct detergent, temperature and treatment of the laundry. → See also [www.sartex.ch](http://www.sartex.ch)

If you visit [www.cleanright.eu](http://www.cleanright.eu), you will find further information on detergents, care products and cleaning agents for domestic use.

- **Standard detergent with optical brighteners**  
Suitable for boil-washable white laundry made from linen or cotton  
Programme: Cottons/  
cold - max. 90 °C
- **Detergent for colours without bleach or optical brighteners**  
Suitable for coloured laundry made from linen or cotton  
Programme: Cottons/  
cold - max. 60 °C
- **Detergent for colours/delicates without optical brighteners**  
Suitable for coloured laundry made from easy-care fibres, synthetic fibres  
Programme: Easy-Care/  
cold - max. 60 °C
- **Detergent for delicates**  
Suitable for delicate, fine fabrics, silk or viscose  
Programme: Delicate/Silk/  
cold - max. 40 °C
- **Detergent for woollens**  
Suitable for wool  
Wool programme/  
cold - max. 40 °C

## Saving energy and detergent

For light and normal soiling, you can save energy (lower washing temperature) and detergent.

Saving	Soiling/note
<p>Reduced temperature and detergent quantity as per the recommended dosage</p>  <p>Temperature as per the care label and detergent quantity as per the recommended dosage for heavy soiling</p>	<p><b>Light</b> No visible dirt or stains. Clothing has taken on some body odour, e.g.:</p> <ul style="list-style-type: none"> <li>■ Light summer/sports clothing (worn for a few hours)</li> <li>■ T-shirts, shirts, blouses (worn for up to one day)</li> <li>■ Guest bed linen and hand towels (used for one day)</li> </ul> <p><b>Normal</b> Visible dirt or a few light stains, e.g.:</p> <ul style="list-style-type: none"> <li>■ T-shirts, shirts, blouses (sweat soaked, worn a few times)</li> <li>■ Towels, bedding (used for up to one week)</li> </ul> <p><b>Heavy</b> Dirt and/or stains clearly visible, e.g. tea towels, baby items, work clothing</p>

**Note:** When measuring the amount of all detergents/additives/care products and cleaning agents, please always check the manufacturer's instructions and information. → Page 44



## Overview of programmes

### Programmes on the programme selector





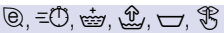



Programme/Type of laundry/Instructions	Settings
<p><b>Name of the programme</b></p> <p>Brief explanation of the programme and for which fabrics it is suitable.</p>	<p>Max. load</p> <p>Temperature that can be selected; (❄ = cold)</p> <p>Spin Speed that can be selected; 0 = no spin cycle, draining only</p> <p>additional programme settings that can be selected*</p> <p>possible automatic dosing:                      ■ of a liquid detergent (⓪) and                      ■ of a fabric softener (⊗) can be selected/deselected ✓, cannot be selected -</p>
<p><b>Cottons</b></p> <p>Hard-wearing fabrics, heat-resistant fabrics made of cotton or linen</p> <p><b>Notes</b></p> <ul style="list-style-type: none"> <li>■ In the <b>EcoPerfect</b> ⓪ (⊖) setting, the washing temperature is lower than the selected temperature. If you would like to set a particular washing temperature, use the programme without the <b>EcoPerfect</b> ⓪ (⊖) setting or, if necessary, set a higher temperature.</li> <li>■ The <b>SpeedPerfect</b> ⊕ (⊃) setting is suitable as a short programme for lightly soiled laundry.</li> </ul>	<p>9 kg/5*** kg</p> <p>❄ - 90 °C</p> <p>0 - 1600** rpm</p> <p>⓪, ⊕, ⊖, ⓪, ⊗, ⊕, ⊖, ⊗, ⊕, ⊖, ⊗</p> <p>Detergent ✓, fabric softener ✓</p>
<p><b>Synthetics</b></p> <p>Textiles made of synthetic materials or blended fabrics</p>	<p>4 kg</p> <p>❄ - 60 °C</p> <p>0 - 1200** rpm</p> <p>⓪, ⊕, ⊖, ⓪, ⊗, ⊕, ⊖, ⊗, ⊕, ⊖, ⊗</p> <p>Detergent ✓, fabric softener ✓</p>
<p>* The programmes and additional programme settings are model-dependent. The programmes/settings that are available can either be selected directly on the control panel or under <b>Additional programmes</b> Programmes or <b>Options</b>.</p> <p>** The maximum spin speed depends on the programme and model</p> <p>*** Reduced load for the <b>SpeedPerfect</b> ⊕ (⊃) setting</p>	































Programme/Type of laundry/Instructions	Settings
<p><b>Mix</b></p> <p>Mixed load of cottons and synthetic fabrics</p>	<p>4 kg</p> <p>❄ - 40 °C</p> <p>0 - 1600** rpm</p> <p>⊗, ≡⊗, ↓, 👑, ↻, ↺, ☹, ☹, ☹</p> <p>Detergent ✓, fabric softener ✓</p>
<p><b>Delicates / Silk</b></p> <p>Delicate, washable fabrics, e.g. made of silk, satin, synthetic fibres or blends (e.g. silk blouses, silk scarves)</p> <p><b>Note:</b> . For delicates or silk, use a detergent suitable for machine-washing.</p>	<p>2 kg</p> <p>❄ - 40 °C</p> <p>0 - 800** rpm</p> <p>⊗, ≡⊗, ↓, 👑, ↻, ☹, ☹</p> <p>Detergent ✓, fabric softener ✓</p>
<p> <b>Wool</b></p> <p>Hand- or machine-washable fabrics that are made of wool or contain wool;</p> <p>particularly gentle wash programme to prevent laundry from shrinking, with longer pauses in the programme (during which the items rest in the water)</p> <p><b>Notes</b></p> <ul style="list-style-type: none"> <li>■ Wool is of animal origin, e.g. Angora, alpaca, llama, sheep.</li> <li>■ For wool, use a detergent that is suitable for machine-washing.</li> </ul>	<p>2 kg</p> <p>❄ - 40 °C</p> <p>0 - 800** rpm</p> <p>☹, ☹</p> <p>Detergent -, fabric softener ✓</p>
<p><b>Hygiene</b></p> <p>Hard-wearing fabrics made of cotton or linen</p> <p><b>Note:</b> . Particularly suited to washing items that need to be hygienically clean and especially kind to sensitive skin thanks to the longer wash cycle at a defined temperature, higher water level and longer spin cycle.</p>	<p>7 kg/5*** kg</p> <p>❄ - 60 °C</p> <p>0 - 1600** rpm</p> <p>⊗, ≡⊗, ↓, 👑, ↻, ↺, ☹, ☹, ☹</p> <p>Detergent ✓, fabric softener ✓</p>
<p><b>Super 15'</b></p> <p>Extra-short programme of approx. 15 minutes, suitable for small items of lightly soiled laundry</p>	<p>2 kg</p> <p>❄ - 40 °C</p> <p>0 - 1200** rpm</p> <p>-</p> <p>Detergent ✓, fabric softener ✓</p>
<p>* The programmes and additional programme settings are model-dependent. The programmes/settings that are available can either be selected directly on the control panel or under <b>Additional programmes</b> Programmes or <b>Options</b>.</p> <p>** The maximum spin speed depends on the programme and model</p> <p>*** Reduced load for the <b>SpeedPerfect</b> ≡⊗ (➤➤) setting</p>	



Programme/Type of laundry/Instructions	Settings
<b>Denim</b> Dark-coloured cottons and dark-coloured easy-care fabrics; Turn items inside-out before washing.	3.5 kg ❄ - 40 °C 0 - 1200** rpm  Detergent ✓, fabric softener ✓
<b>Outdoor *</b> Membrane-coated weatherproof or outdoor clothing and water-resistant fabrics <b>Notes</b> <ul style="list-style-type: none"> <li>■ Use special detergent suitable for machine washing; add the correct dosage to compartment II in accordance with the manufacturer's instructions.</li> <li>■ Laundry must not be treated with fabric softener.</li> <li>■ Before washing, clean the detergent drawer thoroughly (manual compartment) to remove fabric-softener residue.</li> </ul>	Max. 2 kg ❄ - 40 °C 0 - 800** rpm  Detergent -, fabric softener -
<b>Night Wash *</b> Especially quiet programme for washing during the night; suitable for cotton, linen, synthetic and blended fabrics <b>Notes</b> <ul style="list-style-type: none"> <li>■ End signal deactivated,</li> <li>■ Reduced final spin speed set by default and shorter washing time</li> </ul>	Max. 4 kg ❄ - 40 °C 0 - 1600** rpm  Detergent ✓, fabric softener ✓
<b>Duvet *</b> Machine-washable items stuffed with synthetic fibres, such as pillows, quilts and bedspreads; also suitable for items stuffed with down <b>Note:</b> . Wash large items separately. Use a detergent designed for delicates and follow the instructions on the item's care label. Use detergent sparingly.	Max. 2.5 kg ❄ - 60 °C 0 - 1200** rpm  Detergent -, fabric softener -
* The programmes and additional programme settings are model-dependent. The programmes/settings that are available can either be selected directly on the control panel or under <b>Additional programmes</b> Programmes or <b>Options</b> . ** The maximum spin speed depends on the programme and model *** Reduced load for the <b>SpeedPerfect</b> =@ (>>) setting	



Programme/Type of laundry/Instructions	Settings
<p><b>Shirts / Blouses</b></p> <p>Non-iron shirts or blouses made of cotton, linen, synthetic fibres or blended fabrics</p> <p><b>Notes</b></p> <ul style="list-style-type: none"> <li>Shirts/blouses are only given a short spin on the <b>Easy iron</b> (👉) setting. Hang them up to dry while still dripping wet. -&gt; Self-smoothing effect</li> <li>Use the <b>Delicates / Silk</b> programme to wash shirts/blouses made of silk or delicate fabrics.</li> </ul>	<p>Max. 2 kg</p> <p>✳ - 60 °C</p> <p>0 - 800** rpm</p> <p>🌀, 🔄, ⬇️, 👑, 👤, 👤, 👤, 🪥, 🪥, 🪥</p> <p>Detergent ✓, fabric softener ✓</p>
<p><b>Down *</b></p> <p>Machine-washable fabrics stuffed with down, such as pillows and duvets; also suitable for items stuffed with synthetic fibres</p> <p><b>Note:</b> Wash large items separately. Use a detergent designed for delicates and follow the instructions on the item's care label. Use detergent sparingly.</p>	<p>Max. 2 kg</p> <p>✳ - 60 °C</p> <p>0 - 1200** rpm</p> <p>🌀, 🔄, 👑, 👤, 🪥</p> <p>Detergent -, fabric softener ✓</p>
<p><b>Towels *</b></p> <p>Hard-wearing, heat-resistant towels made of cotton; especially soft towels</p>	<p>Max. 3.5 kg</p> <p>✳ - 90 °C</p> <p>0 - 1600** rpm</p> <p>🌀, 🔄, ⬇️, 👑, 👤, 👤, 👤, 🪥, 🪥, 🪥</p> <p>Detergent ✓, fabric softener ✓</p>
<p><b>Lingerie *</b></p> <p>For delicate, washable underwear, e.g. made of velvet, lace, Lycra, silk or satin</p>	<p>Max. 1 kg</p> <p>✳ - 40 °C</p> <p>0 - 600** rpm</p> <p>🌀, 🔄, 👑, 👤, 👤, 👤, 🪥, 🪥, 🪥</p> <p>Detergent -, fabric softener ✓</p>
<p><b>Curtains *</b></p> <p>3.5 kg heavy curtains or 25 - 30 m<sup>2</sup> lightweight drapes</p> <p><b>Notes</b></p> <ul style="list-style-type: none"> <li>Shorter rinse and final spin cycles,</li> <li>Use a detergent that is suitable for machine-washing curtains.</li> <li>The <b>Prewash</b> (⬇️) button is set by default. If you do not require a pre-wash cycle, press the button to deactivate the function.</li> </ul>	<p>Max. 3.5 kg</p> <p>✳ - 40 °C</p> <p>0 - 800** rpm</p> <p>🌀, 🔄, ⬇️, 👑, 👤, 👤, 👤, 🪥, 🪥, 🪥</p> <p>Detergent ✓, fabric softener ✓</p>
<p>* The programmes and additional programme settings are model-dependent. The programmes/settings that are available can either be selected directly on the control panel or under <b>Additional programmes</b> Programmes or <b>Options</b>.</p>	
<p>** The maximum spin speed depends on the programme and model</p>	
<p>*** Reduced load for the <b>SpeedPerfect</b> (🔄 (➤➤)) setting</p>	

Programme/Type of laundry/Instructions	Settings
<b>Drum clean</b> * Programme for cleaning and caring for the drum and the outer tub, e.g. before running the first wash cycle, if washing frequently at a low temperature (40 °C or lower) or if an odour has developed after a prolonged period of non-use. The <b>Drum clean</b> indicator lamp flashes when you use have not used a programme of 60 °C or higher for a long time.	0 kg 80, 90 °C 1200 rpm  Detergent -, fabric softener -
<b>Notes</b> <ul style="list-style-type: none"> <li>Run the drum care programme without any laundry.</li> <li>Use washing powder or a detergent containing bleach. To prevent foaming, only use half the amount of detergent recommended by the detergent manufacturer. Do not use detergents designed for woollens or delicates.</li> </ul>	
<b>Rinse</b> * Rinse Plus with spin	- - 0 - 1600** rpm  ,  ,  ,  Detergent -, fabric softener ✓
<b>Spin</b> * Extra spin with selectable speed	- - 0 - 1600** rpm  Detergent -, fabric softener -
<b>Gentle spin</b> * Extra spin cycle at reduced speed and with especially gentle spin mechanism.	- - 0 - 1200** rpm - Detergent -, fabric softener -
<b>Drain</b> * For the rinsing water, e.g. after the  setting (Rinse Hold = no final spin cycle)	- - - - Detergent -, fabric softener -
* The programmes and additional programme settings are model-dependent. The programmes/settings that are available can either be selected directly on the control panel or under <b>Additional programmes</b> Programmes or <b>Options</b> .	
** The maximum spin speed depends on the programme and model	
*** Reduced load for the <b>SpeedPerfect</b>  (  ) setting	

Programme/Type of laundry/Instructions	Settings
<p><b>Sportswear *</b></p> <p>Sportswear and leisurewear made from microfibre fabrics</p> <p><b>Notes</b></p> <ul style="list-style-type: none"> <li>■ Laundry must not be treated with fabric softener.</li> <li>■ Before washing, clean the detergent drawer thoroughly (manual compartment) to remove fabric-softener residue.</li> </ul>	<p>Max. 2 kg</p> <p>❄ - 40 °C</p> <p>0 - 800** rpm</p> <p>         </p> <p>Detergent -, fabric softener -</p>
<p><b>Automatic *</b></p> <p>Hard-wearing fabrics;</p> <p>The degree of soiling and the type of fabric are automatically detected and the washing sequence and intelligent dosing are adjusted accordingly.</p>	<p>Max. 6 kg</p> <p>40 °C</p> <p>1400** rpm</p> <p> </p> <p>Detergent ✓, fabric softener ✓</p>
<p><b>Automatic Soft *</b></p> <p>Gentler treatment of the laundry;</p> <p>The degree of soiling and the type of fabric are automatically detected and the washing sequence and intelligent dosing are adjusted accordingly.</p>	<p>Max. 3.5 kg</p> <p>30 °C</p> <p>1000** rpm</p> <p> </p> <p>Detergent ✓, fabric softener ✓</p>
<p><b>Auto. Intensive *</b></p> <p>More intensive treatment of the laundry;</p> <p>The degree of soiling and the type of fabric are automatically detected and the washing sequence and intelligent dosing are adjusted accordingly.</p>	<p>Max. 6 kg</p> <p>60 °C</p> <p>1400** rpm</p> <p> </p> <p>Detergent ✓, fabric softener ✓</p>
<p><b>Disinfectant *</b></p> <p>Mixed load of cottons and synthetic fabrics;</p> <p>Special programme (with prewash and additional rinse) for disinfecting laundry</p> <ol style="list-style-type: none"> <li>1. Select a programme.</li> <li>2. Add disinfectant into compartment  .</li> <li>3. Automatically add liquid detergent for the main wash using the i-DOS function. If necessary, activate the i-DOS function for detergent.</li> </ol> <p><b>Note:</b> . Do not add a powder detergent.</p> <ol style="list-style-type: none"> <li>4. Start the programme immediately. Do not select Finished in.</li> </ol>	<p>Max. 4 kg</p> <p>40 °C</p> <p>0 - 1600** rpm</p> <p>         </p> <p>Detergent ✓, Weichspüler ✓</p>
<p>* The programmes and additional programme settings are model-dependent. The programmes/settings that are available can either be selected directly on the control panel or under <b>Additional programmes</b> Programmes or <b>Options</b>.</p> <p>** The maximum spin speed depends on the programme and model</p> <p>*** Reduced load for the <b>SpeedPerfect</b>   setting</p>	

## Starching

**Note:** Laundry should not be treated with fabric softener.

1. Switch on the appliance.
2. Select the **Rinse** programme.
3. Pour liquid starch into compartment   in accordance with the manufacturer's instructions (clean first if necessary).
4. Press the  button.

## Dyeing/bleaching

Dye should only be used in normal household quantities. Salt may damage stainless steel. Always follow the dye manufacturer's instructions.

Do **not** use the washing machine to bleach clothes.

## P+ Programme default settings

The programme default settings are displayed in the main menu after selecting the programme.

Display panel → *Page 27*

You can change the default settings:

- Temperature, Spin Speed and Finished in as long as the arrow is displayed in the main menu and/or
- the i-Dos settings → *Page 27*, → *Page 39*

An overview of all programme settings, which can be selected depending on the programme, can be found from → *Page 31*.

### Temperature

Depending on what stage the programme is in, you can change the set temperature before and during the programme.

The maximum temperature that can be set depends on the programme that has been selected.

### Spin Speed

Depending on what stage the programme is in, you can change the spin speed (in rpm; revolutions per minute) before and during the programme.

The maximum speed that can be set depends on the model and programme that has been selected.

**Setting 0:** No spin cycles, the water is only drained. The laundry stays wet inside the drum, e.g. for items that should not be spun.

### Finished in

The programme duration is shown after selecting the programme.

**Before starting the programme**, you can preselect the programme end in hourly increments (h = hour) up to a maximum of 24 hours.

**After starting the programme**, the selected number of hours **e.g. 8 h** is shown on the display panel and counts down until the wash programme starts. The duration of the programme is then displayed.

**Note:** The programme duration is automatically adjusted when the programme is running. Changes to the programme default settings or programme settings, options, foam detection function, unbalanced load detection, the load or soiling may also change the programme duration.

**After starting the programme**, you can change the preselected number of hours as follows:

1. Press the  button.
2. Use the **Finished in** button to change the number of hours.
3. Press the  button.

**After starting the programme**, while the programme is running, you can add or remove laundry if necessary.  
→ *Page 46*

## i-DOS settings





Your washing machine has an intelligent dosing system for liquid detergent and fabric softener (or detergent when using the setting **Dispenser content:**

**Detergent** → *Page 52*)

For the majority of programmes on your washing machine, detergent and fabric softener are dosed automatically.





The i-DOS settings are not retained when the appliance is switched off.

The following have been preset at the factory:

- i-DOS  :   
Detergent dosage for lightly soiled laundry
- i-DOS  :   
Fabric softener dosage for a medium level of softness

## i-DOS for detergent





### Dosage strengths

-  High: heavy soiling and staining
-  Medium: average soiling
-  Low: light soiling
-  Automatic dosage deselected, manual dosage → *Page 51*

You can change the settings for automatic detergent dosage before the programme starts. You can find information on degrees of soiling on → *Page 30*

## i-DOS for fabric softener

### Dosage strengths

-  High: high level of softness
-  Medium: medium level of softness
-  Low: low level of softness
-  Automatic dosage deselected

Depending on what stage the programme is in, you can change the settings for automatic detergent dosage.

## **P+** Additional programme settings/options (\* depending on the model)

The settings/options that are available depend on the model.

Depending on the programme selected, you can select different settings/options in order to better adapt the washing process to your items of laundry.

### **The settings can be selected:**

- via the corresponding button on the control panel or
- via the Options button. → *Page 26*

An overview of all additional settings, which can be selected depending on the programme, can be found from → *Page 31*.

## **SpeedPerfect**

(>>)

Washing in a shorter time while achieving a washing result that is consistent with, but uses more energy than, the selected programme, without the SpeedPerfect  setting.

**Note:** Do not exceed the maximum load.

Overview of programmes → *Page 31*

## **EcoPerfect**

(⊖)

Energy-optimised washing by reducing the temperature while achieving a washing result that is consistent with the selected programme, without the EcoPerfect  setting.

## **Prewash** \*



(↓)

Settings that can be selected:

**on – off**

For heavily soiled laundry.



### **Notes**

- If **intelligent dosage is selected**, the detergent will be dispensed automatically for the prewash and the main wash.
- Set the i-DOS dosage to **medium** to prevent overdosing.
- If **dosing manually**, allocate detergent to the prewash and the main wash. Place detergent for the prewash in the drum and add detergent for the main wash to compartment  .

## **Rinse plus** \*

(↑)

Settings that can be selected:

-  **+ 1 rinse cycle**
-  **+ 2 rinse cycles**
-  **+ 3 rinse cycles**

**Off**

Additional rinse cycles for particularly sensitive skin and/or for areas with very soft water.

Longer program duration.

The number of rinse cycles that the appliance actually runs depends on the number that is set as a basic setting for the program in question.



## Water plus \*



Settings that can be selected:

**on – off**

Increased water level, gentler treatment of the laundry.

## Easy iron \*



Settings that can be selected:

**on – off**

Reduces creasing thanks to a special spin sequence followed by fluffing and reduced spin speed.

**Note:** The washing's residual moisture is increased.

## Soaking \*





Settings that can be selected:



**on – off**



Before the main wash cycle starts, the washing remains for longer in the water to partially dissolve intensive soiling.

To be used for particularly stubborn soiling.

Dose the detergent using i-DOS or add it into the   compartment in accordance with the manufacturer's instructions.

### Notes

- Load laundry of the same colour.
- If your machine does not have this option, you can soak as follows:
  1. Select i-DOS or dose detergent in the   manual compartment in accordance with the manufacturer's instructions.
  2. Select the **Cottons 30 °C** programme and the  button.

3. Press the  button after approx. 10 minutes. The laundry remains in the soaking solution.
4. Leave the laundry to soak for as long as required, then either press the  button again to continue the programme or change the programme.
 

**Note:** No additional detergent is required; the soaking solution is used for washing.

## Rinse hold \*



Settings that can be selected:

**on – off**

The washing remains in the water after the last rinse cycle. End the programme → *Page 46*

## Silent Wash \*



Settings that can be selected:

**on – off**

Reduced noise values thanks to special wash and spin cycle and deactivated end signal. Especially suitable for washing at night.

















**Note:** Residual moisture of the washing is slightly increased.

## Stains \*



In total, there are 16 different types of stain to choose from.

### Types of stain that can be selected:

-  Baby food
-  Blood
-  Egg
-  Strawberry
-  Soil + sand
-  Grass
-  Coffee
-  Cosmetics
-  Orange
-  Red wine
-  Chocolate
-  Sweat
-  Dirty socks
-  Grease + oil
-  Tea
-  Tomatoes

### off

Do not let stains dry. Remove solid substances beforehand.

### Select a programme with a stain type:

1. Arrange items of washing as usual.
2. Select a programme.
3. Load the washing machine
4. Select a stain type (depending on the selected programme).
5. Start the programme.

The washing machine adjusts the average washing temperature, drum movement and soaking time to the specific type of stain. Hot or cold water, gentle or intensive washing and long or short soaking ensure that the wash-programme sequence is specially adapted to each type of stain. This makes sure that stains are treated in the best possible way.

### The treatment of two stains explained in the following example:

#### Blood

Blood is first “dissolved” in cold water, then the selected wash programme starts.

#### Egg

Egg particles are removed by soaking in the lukewarm water bath, selecting a wash cycle with a high water level and running additional rinse cycles.

Following intensive research, we have developed comparable solutions for other stains.



## Operating the appliance

### Preparing the washing machine

**Note:** The washing machine **must be correctly installed** and **connected**.

From → *Page 15*

1. Plug into the mains.
2. Turn on the tap.
3. Open the washing machine door.
4. Check that the drum is completely drained. Drain if necessary. Otherwise, the load display may malfunction. → *Page 53*

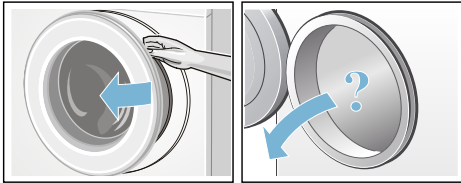

### Switching on the appliance/ selecting a programme

Press the **I** button. The appliance is switched on.

The Gaggenau logo appears on the display and all indicator lamps light up.

The **Cottons** programme set at the factory is then always displayed.

You can:

- use this programme **or**
- select another programme on the control panel **or**
- select a programme under **Additional programmes**.  
→ *Page 27*

**Note:** If you have activated the childproof lock, you must deactivate it before you can set a programme.

The indicator lamp on the programme selector lights up and the main menu with the **programme default settings** for the selected programme appear on the display panel:

- Temperature,
- Spin speed,
- Programme duration,
- i-DOS settings,
- Any additional settings and
- Information on water and energy consumption. → *Page 14*

In appliances with a **drum light**:

The drum is lit after switching on the appliance, after opening and closing the door and after starting the programme. The light switches off automatically.

You can:

- use the programme default settings and load laundry → *Page 44*,
- or change the programme default settings and/or select additional settings.

### Change the programme default settings

You can use or change the default settings for each washing cycle.

To do this, repeatedly press the corresponding button until the required setting is displayed. → *Page 38*

**Note:** Pressing and holding the buttons automatically runs through the set values.

The settings are activated without needing to be confirmed.



After the appliance is switched off, the i-DOS settings for **I** **△** and **△** are retained. All other settings are not saved and must be selected again.

Programme default settings  
→ *Page 31*

## Select additional programme settings

By selecting additional settings/options, you can better adapt the washing process to your items of laundry.

The settings can be selected or deselected depending on the progress of the programme. → *Page 27*

The EcoPerfect  and SpeedPerfect  button indicator lamps light up if a setting is activated.

The other settings are indicated by a symbol on the display panel if the setting is activated.

For multi-level settings, press and hold the buttons to run through the settings automatically.

The settings are not saved after the washing machine is switched off.

Additional programme settings/options → *Page 40*

## Placing laundry into the drum

### **Warning** **Risk of death!**

Items of laundry pretreated with cleaning agents that contain solvents, e.g. stain remover/cleaning solvent, may cause an explosion after being loaded into the washing machine. Hand-rinse these items of laundry thoroughly beforehand.

Load the pre-sorted, unfolded laundry into the drum. The load screen for the selected programme (e.g. **Synthetics**) is indicated on the display panel.

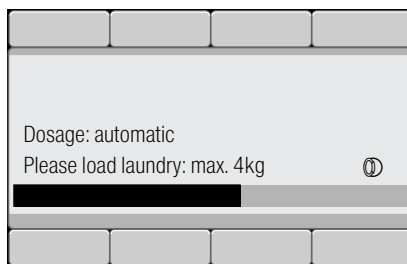



The load bar fills as the laundry is loaded. If the maximum load is exceeded, the bar flashes. Observe the maximum indicated load. Overfilling adversely affects the washing result and encourages creasing.



### Notes

- Mix items of laundry of varying sizes. Laundry items of different sizes distribute themselves better during the spin cycle. Individual laundry items may cause an unbalanced load.
- Wait until the Gaggenau logo no longer appears before adding laundry.
- The load screen appears when the door is opened or when the amount of laundry is changed.

## Measure and add detergent and care products

For the majority of programmes on your washing machine, detergent and fabric softener are dosed automatically; it is a factory setting for these programmes and can be changed. → *Page 31*

In addition to intelligent dosing, you can manually add cleaning aids (e.g. softener, bleach or stain remover) to compartment  , if necessary. → *Page 51*

For programmes without intelligent dosing, or as desired (in which case, set intelligent dosing to  (off)), detergent can be added manually to compartment  . → *Page 51*

## Start the programme

Make sure that no items of laundry are trapped between the door and the rubber seal, and close the door.

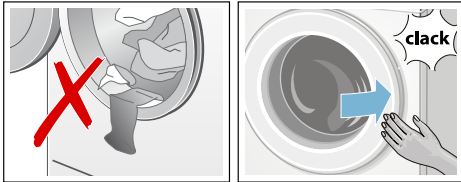

The main menu for the selected programme is indicated again on the display panel.

Press the  button to start the programme.

During washing, the progress of the programme is displayed in a bar on the display panel. The bar fills in during the washing cycle and provides information about the current progress of the programme.

The arrows fade in and out according to the progress of the programme. They indicate the programme settings/options which can be changed/added as the programme progresses.

### Some programme sequence steps explained:

- **Load adjust active** → Page 53

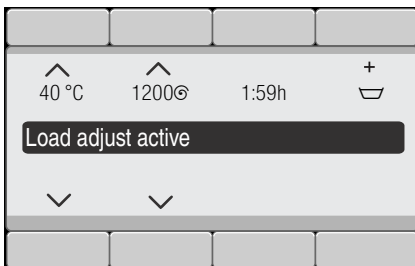

- **Pre-washing, Washing, Rinsing, Spin, Drain ...** are displayed during the wash cycle.
- **Extra rinse: foam**

### Note: Foam detection



If **Foam has been detected** also appears on the display panel, the washing machine has detected too much foam during the wash programme and has automatically switched on one or more rinse cycles in order to remove the foam. Add less detergent to the next washing cycle with the same load.

- Other displays → Page 59

If you want to lock the programme to prevent it from being inadvertently adjusted, you can select the childproof lock as follows.

### Child lock. 3 sec.

You can lock the washing machine to prevent the functions you have set from being changed inadvertently.

To **activate**/deactivate, press and hold both buttons **Child lock.  3 sec.** for approx. three seconds. → Page 26  
 **Childproof lock activated** appears in the display panel.

After approx. three seconds, the display reverts back to the main menu.

If you adjust the programme selector or select a button when the childproof lock is activated,  **Childproof lock activated** appears in the display panel.

### Notes

- The childproof lock can be activated regardless of the appliance's status.
- The childproof lock remains active, even once the washing machine has been switched off. Before selecting the next programme, deactivate the childproof lock.
- If the appliance is switched off while the programme is running and childproof lock is activated, the programme continues when the appliance is switched back on.

## Adding laundry

After starting the programme, you can add or remove laundry if necessary.

Press the ▷ button to do this.

The ▷ button indicator lamp flashes and the machine checks whether it is possible to add laundry.

It is possible to add laundry when **Pause: Reload is possible** appears on the display.

**To continue the programme, press the ▷ button.** The programme continues automatically.

### Notes

- Do not leave the door open for too long when adding laundry as water from the laundry may leak out.
- For safety reasons, the door remains locked when the water level or temperature is high, or while the drum is turning, and it is not possible to add laundry during this time. Follow the information on the display panel.
- The load display is not active during reloading.

## Changing the programme

If you have started the wrong programme by mistake, you can change the programme as follows:

1. Press the ▷ button.
2. Select another programme.
3. Press the ▷ button. The new programme starts from the beginning.

## Cancel the programme

For programmes at high temperatures:

1. Press the ▷ button.
2. To cool down laundry: Select **Rinse**.
3. Press the ▷ button.

For programmes at low temperatures:

1. Press the ▷ button.
2. Select **Spin** or **Drain**.
3. Press the ▷ button.

## Programme end during rinse hold

The following appears on the display panel:

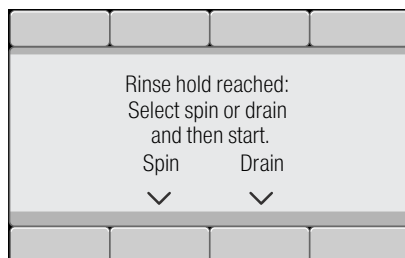

Continue the programme by:

- Select the **Spin** (change the spin speed if necessary) or the **Drain** programme.
- Press the ▷ button.

## Programme end

🕒 **Finished, remove washing** appears on the display panel. The ▷ button indicator lamp is off.

## Removing laundry/switching off the appliance

1. Open the loading door and remove the laundry. Follow the information on the display panel.
2. Press the ① button. The appliance is switched off.
3. Turn off the tap.  
**Note:** Not required for AquaStop models.

### Notes

- Do not leave any items of laundry in the drum. They may shrink in the next wash or discolour another item.
- Remove any foreign objects from the drum and the rubber gasket – risk of rusting.
- Wipe the rubber gasket dry.



### Notes

- Leave the loading door and detergent drawer open so that any residual water can evaporate.
- Always wait until the programme ends, as the appliance could still be locked. Then switch the appliance on and wait for it to unlock.
- If the display panel goes off at the end of a programme, the energy-saving mode is active. Press any button to activate the panel.



i-DOS

## Intelligent dosing system





### Intelligent dosing system in the detergent drawer

#### i-DOS Intelligent Dosing system

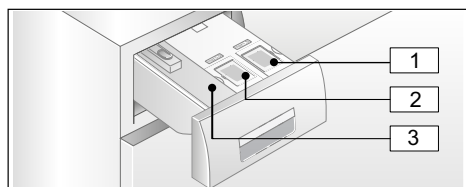
Your washing machine has an intelligent dosing system for liquid detergent and fabric softener.

The i-DOS compartments  and  in the detergent drawer are used for this purpose. You can choose whether you would like to use one liquid detergent and one fabric softener or two liquid detergents. Dispenser selection → *Page 52*



- 1 Dispenser  (1.3 l) for liquid detergent
- 2 Dispenser  (0.5 l) for fabric softener (or detergent with dispenser selection)
- 3 Compartment   for manual dosing

Depending on the programme selection and settings, the optimum amounts of detergent/fabric softener are dosed via the i-DOS dispenser.

### Initial use/filling the dispensers

Refer to the manufacturer's instructions when choosing your detergent and fabric softener. We recommend the use of standard, universal and colour liquid detergents for all machine-washable, coloured fabrics made of cotton or synthetic materials.

#### Notes

- Only use easy-pour liquid products that the manufacturer recommends adding to the detergent drawer.
- Do not mix different liquid detergents. If changing your liquid detergent (type, manufacturer, etc.), empty the dispenser completely and clean it. → *Page 55*
- Do not use products containing solvents, caustic agents or volatile substances (e.g. bleach).
- Do not mix detergent and fabric softener.
- Do not use products that have expired or are highly congealed.
- To prevent drying out, do not leave the dispenser lids open for a long period of time.

#### Filling the dispensers:

The dispenser covers in the detergent drawer are marked with the following symbols:

-  Standard/universal detergent
-  Fabric softener

1. Open the detergent drawer.
2. Open the dispenser cover(s).
3. Add detergent/fabric softener. Do not fill above the **max.** marking.

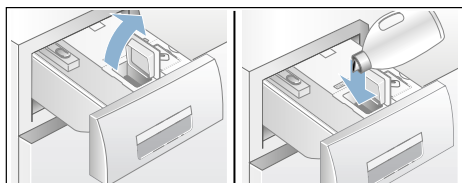

4. Close the cover(s).
5. Slowly push the detergent drawer in completely.



When the appliance is switched on, the fact that the detergent drawer is closed completely is indicated by the following:

- the corresponding illuminated display on the drawer handle lights up when intelligent dosing i-DOS  $\circ$ , i-DOS  $\otimes|\circ$  is selected.
- the display flashes once and then goes out if intelligent dosing is not selected.

## Everyday use

### Illuminated displays on the drawer handle:

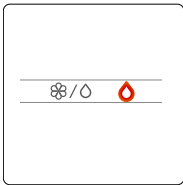

- The display **lights up** if intelligent dosing is selected for the corresponding dispenser:
  - $\circ$  for dispenser  $\otimes$  (detergent),
  - for the  $\otimes|\circ$  illuminated display for the combined compartment  $\otimes/\otimes$ , the lamp for the appropriate dispenser content lights up:  $\otimes$  for fabric softener/ $\circ$  for detergent. → *Page 48*
- The display **flashes** if the fill level of the selected intelligent dosing dispenser is below the minimum level.

### (De)selecting intelligent dosage and adjusting the dosage strength:

The intelligent dosages for detergent and fabric softener are set at the factory for programmes in which intelligent dosing can be used.

Overview of programmes → *Page 31*

The dosage strength has been preset to low (lightly soiled laundry) for detergent  $\circ$  and to medium (medium level of softness) for fabric softener  $\otimes$ . It can be changed for each programme. → *Page 39*

In addition to intelligent dosing, cleaning aids (e.g. stain remover) can be added manually to compartment  $\otimes$   $\otimes$ , if necessary. → *Page 51*

**Note:** Depending on the programme, the selection (on/off) as well as the relevant dosage strength that has been selected for i-DOS  $\otimes|\circ$  and i-DOS  $\circ$  are saved until they are changed, even when the machine is switched off.

### Topping up the detergent/ fabric softener:

If, while intelligent dosing is selected, the respective illuminated display flashes and there is corresponding information on the display panel, this indicates that the minimum fill level has not been reached. The content is sufficient for approx. 3 washes.

The same detergent or fabric softener can be added at any time. If you change product/manufacturer, we recommend that you clean the dispensers first. → *Page 55*

If required, adjust the basic dosage.

## Base dosage

### The basic dosages are:

- **For detergents** – based on the manufacturer's recommendation for average soiling and the respective water hardness.
- **F or fabric softeners** – based on the manufacturer's recommendation for a medium level of softness.

Refer to the packaging label on your detergent/fabric softener or ask the manufacturer directly for this information.

To find out the hardness of your water supply, use a test strip or check with your water supplier.

The default setting for the basic dosage is set specifically according to the area in which you live (e.g. 75 ml for detergent and 36 ml for fabric softener).

Set the basic detergent dosage according to the detergent's packaging label. Take your water hardness into consideration when doing so.

Select the basic fabric softener dosage according to how soft you would like your laundry to be.

Changing one basic dosage affects all three dosage quantities in the same way.

### Notes

- Reduce the basic dosage if using a very concentrated detergent.
- If large amounts of foam are repeatedly created during washing, please check your basic dosage and dosage quantity settings. Certain types of liquid detergent can also create excessive amounts of foam. If your basic dosage and dosage quantity settings are correct, we advise you to use a different detergent.





### Changing the basic dosages:

Appliance settings → *Page 52*

## Dispenser content for i-DOS

Instead of fabric softener, a second liquid detergent can be used in the i-DOS  dispenser.



### Notes



- When switching the i-DOS  dispenser content from **fabric softener to detergent**, the basic dosage for detergent is set to factory settings for this dispenser and the dosage for this detergent is set to **off** for all programmes in which intelligent dosing can be used. Then, using the i-DOS  button on the display panel, select the detergent dosage (low, medium or high). → *Page 27*
- The i-DOS  dispenser is automatically deactivated if detergent dosing is activated for the i-DOS  dispenser. The settings for this programme are saved until they are changed.
- When switching the i-DOS  dispenser content to **fabric softener**, the basic dosage is set to factory settings and the dosage is set to "normal" for all programmes in which intelligent dosing can be used.
- Switching the dispenser content requires additional confirmation via the display panel.

### Changing the dispenser content:

Appliance settings → *Page 52*

## Manual dosage

In addition to intelligent dosing, you can manually add cleaning aids (e.g. softener, bleach or stain remover) to compartment  , if necessary.

For programmes without intelligent dosing, or as desired (in which case, set intelligent dosing to ) (off)), detergent can be added manually to compartment  .

### **Warning**

#### **Eye/skin irritation!**

Detergent and care products may spray out if the detergent drawer is opened while the appliance is in operation. Open the drawer carefully.

Rinse eyes or skin thoroughly if they come into contact with detergent/care products.

If swallowed accidentally, seek medical advice.

### **Caution!**

#### **Damage to the appliance**

Cleaning agents and agents for pretreating laundry (e.g. stain removers, prewash sprays, etc.) may cause damage if they come into contact with the surfaces of the washing machine.

Do not allow these agents to come into contact with the surfaces of the washing machine. If necessary, immediately wipe away spray residue and other residues/droplets with a damp cloth.



### **Notes**

- When dosing all detergents, cleaning aids and cleaning agents, always follow the manufacturer's instructions.
- If dosing detergent manually, do not add additional detergent to the intelligent dosing dispenser (set intelligent dosing to ) (off)). This will prevent overdosing and foaming
- Dilute viscous fabric softener and fabric conditioner with water to prevent blockages.

## Dosing and adding detergent:

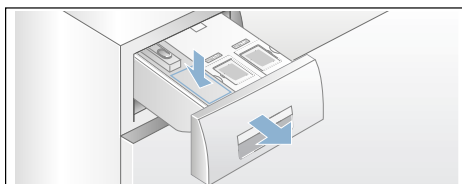
1. Pull out the detergent drawer.





2. Add the correct dosage to compartment   depending on:
  - Soiling
  - Water hardness (ask your water supply company)
  - The amount of laundry
  - The manufacturer's instructions
3. Close the detergent drawer.



## Appliance settings

You can change the following appliance settings:

### Settings that can be selected:

- **End signal**  
**off – quiet – medium – loud – very loud**  
Adjust the volume of the end signal.
- **Button signal**  
**off – quiet – medium – loud – very loud**  
Adjust the volume of the button signals.
- **Auto power-off of the appliance in 15 – 30 – 60 min – never**  
The appliance automatically switches off after ... minutes (= 0 kWh energy consumption); to switch on, press the ① main switch button.
- **Language**  
**German**  
**English**  
...  
Change the displayed language.
- **Info: Drum cleaning**  
**on – off**  
This instruction reminds you to carry out a drum cleaning programme.
- **Dispenser content:**  
i-DOS  content  
**Fabric softener - detergent**  
Select/change the dispenser content.
- **Basic dosage:**  
i-DOS  basis  
**10 ml – 200 ml**  
Set the basic dosage in accordance with the recommendations of the detergent/fabric softener manufacturer.
- **Basic dosage:**  
i-DOS  basis  
**10 ml – 200 ml**  
Set the basic dosage in accordance with the recommendations of the detergent manufacturer.

To change the settings, press and hold both **Basic settings 3 sec.** buttons for approx. 3 seconds. → *Page 28*

### Notes

- The settings are retained after the appliance is switched off.
- If you press and hold the buttons, the settings run through automatically.



## Sensors

### Automatic load sensing

Depending on the type of fabric and load, the automatic load sensing function optimally adjusts the water consumption and programme duration in each programme.

### Unbalanced load detection system

The automatic unbalanced load detection system detects imbalances and ensures even distribution of the laundry by repeatedly starting and stopping drum spinning.

If the laundry is extremely unevenly distributed, the speed is reduced or the spin cycle is not performed for safety reasons.

**Note:** Place large and small items of laundry evenly in the drum.

→ Page 44, → Page 60

### AquaSensor

Depending on the program and model

During a rinse cycle, the Aqua sensor checks the turbidity of the rinsing water (turbidity is caused by dirt and detergent residue). The duration and the number of rinse cycles depend on the turbidity of the water.

### Load sensor/display

The load sensor detects the load level in the washing machine when the door is open. This is indicated by the bar filling on the display panel.

**Note:** In order for the load sensor to fully determine the amount of laundry, the drum must be empty before the washing machine is switched on.

### Dosing recommendation

The dosing recommendation indicates a recommended detergent dosage as a percentage, depending on the selected programme and the detected load. The indicated % refers to the dosing recommendation of the detergent manufacturer.

**Note:** By adhering to the dosing recommendation, you can help look after both the environment and your household budget.



## Cleaning and maintenance



### **Warning**

#### **Danger of death!**

There is a risk of electric shock if you touch live components. Switch off the appliance and pull out the mains plug.



### **Warning**

#### **Risk of poisoning!**

Toxic vapours can be produced by cleaning agents that contain solvents, e.g. cleaning solvent. Do not use cleaning agents that contain solvents.

### **Caution!**

#### **Damage to the appliance**

Cleaning agents that contain solvents, e.g. cleaning solvent, can damage surfaces and components in the machine. Do not use cleaning agents that contain solvents.

#### **Prevent detergent residue from building up and odours from forming by following these instructions:**

### **Notes**

- Ensure the room in which the washing machine is set up is well ventilated.
- Leave the door and detergent dispenser tray open slightly when the washing machine is not in use.
- Occasionally run a wash using the **Cottons 60 °C** programme and powder detergent.

## Machine housing/control panel

- Wipe the housing and the control panel with a soft, damp cloth.
- Remove the detergent residue immediately.
- Do not clean with a water jet.

## Drum

Use chlorine-free cleaning agents, do not use steel wool.

If there are odours in the washing machine, or to clean the drum, run the **Drum clean 90 °C** programme without laundry. Add washing powder.

## Descaling

Descaling should not be necessary if the detergent is measured out correctly. However, if it is required, follow the manufacturer's instructions for the descaling agent. Suitable descalers can be obtained via our website or from customer services. → *Page 62*

## i-DOS detergent draw and its housing

### 1. Emptying the dispensers:

The dispensers have emptying outlets with removable sealing plugs at the front. To empty the dispensers, first remove the drawer handle as shown below:

a) Pull out the detergent drawer.

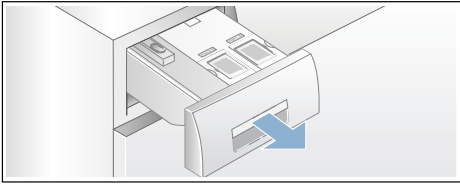

b) Pull the catch (A) on the back of the drawer handle (in the centre at the bottom) slightly towards you. This unlocks the drawer handle (B), which you can then pull off by lifting it upwards.

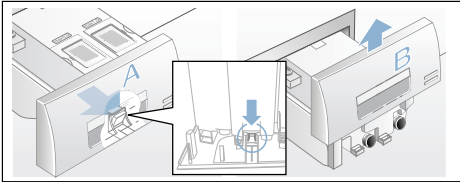

c) To empty the dispensers, carefully pull off each of the sealing plugs and empty the contents into a suitable container.

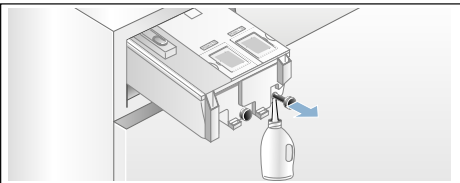

d) Then push the sealing plugs back in completely.

### 2. Cleaning the dispensers/detergent drawer:

The detergent drawer can be removed completely to allow you to clean to dispensers after you have emptied them.

a) Empty the dispensers before removing the drawer.

**Note:** Only put the drawer handle back on after you have finished cleaning.

b) Pull out the drawer.

c) Press the catch and remove the drawer completely.

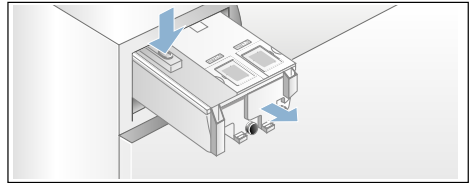

d) Carefully remove the drawer cover.

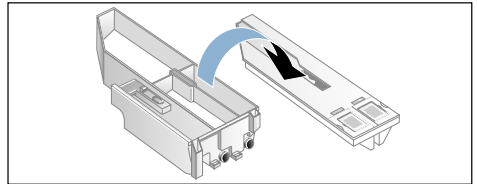

### Caution!

Risk of damage to the detergent drawer.

The detergent drawer contains electrical components. These may become damaged if they come into contact with water.

- Do not clean the cover in the dishwasher and do not immerse it in water.

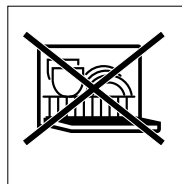

en Cleaning and maintenance

- Protect the rear drawer connector against water, detergent or fabric-softener residue; if necessary, clean the outer surfaces with a soft, damp cloth. Dry before putting back in.
- e) Clean the drawer and the cover with a soft, damp cloth or a hand shower. Also clean the inner surfaces with a soft, damp cloth.

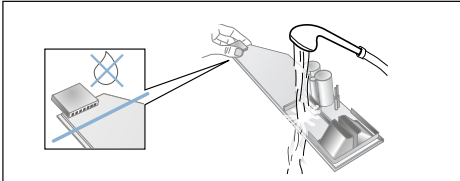

- f) Dry the drawer and the cover and put them back together.
- g) Push the drawer handle back in from above until you feel it click in place.
- h) Clean the inside of the detergent-drawer housing.
- i) Push the detergent drawer in completely.

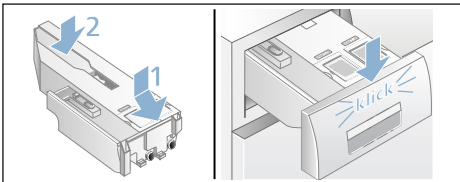

## The drain pump is blocked, emergency draining

**⚠ Warning**  
**Risk of scalding!**

When you wash at high temperatures, the water gets very hot. If you come into contact with the hot water, you may be scalded.

Allow the water to cool down.

1. Turn off the water tap so that no more water can flow in and has to be drained via the drain pump.
2. Switch off the appliance. Pull out the mains plug.
3. Open and remove the service flap.

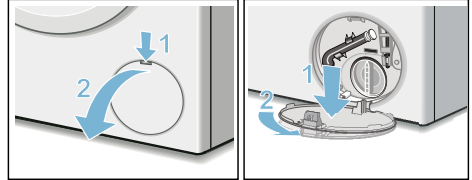

4. Take the drain hose out of the retainer. Remove the sealing cap and pour the water out into a suitable container. Replace the sealing cap and place the drain hose back in the retainer.

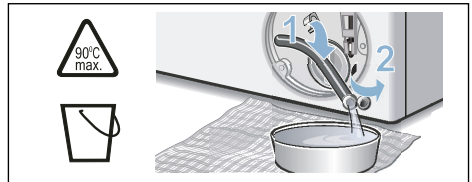

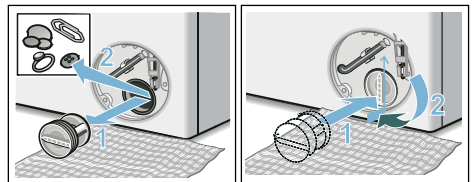

5. Carefully unscrew the pump cover; residual water may leak out. Clean the interior, pump-cover thread and pump housing. The impeller in the drain pump must be able to rotate. Refit the pump cover and screw it on tightly. The handle must be in a vertical position.



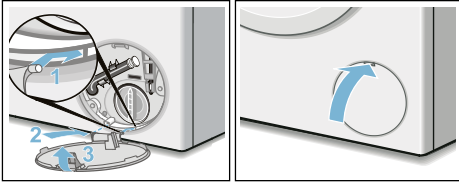

- Put the service flap back on, lock it into place and close it.



**Note:** To prevent unused detergent from flowing straight into the drain during the next wash, pour 1 litre of water into compartment  and start the **Drain** programme.

## The drain hose at the siphon is blocked

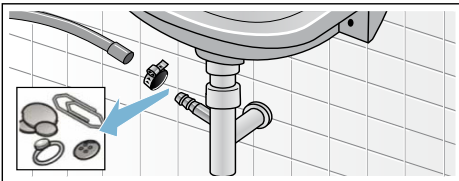

- Switch off the appliance. Pull out the mains plug.
- Loosen the hose clamp. Carefully remove the drain hose; residual water may leak out.
- Clean the drain hose and siphon connecting piece.



- Re-attach the drain hose and secure the connection point using the hose clamp.

## Filter in the water supply blocked

**First, reduce the water pressure in the supply hose:**

- Turn off the tap.
- Select any programme (except Rinse/Spin/Empty).
- Press the  button. Allow the programme to run for approximately 40 seconds.
- Press the  button. The appliance is switched off.
- Pull out the mains plug.

**Then clean the filter:**

- Disconnect the hose from the tap. Clean the filter with a small brush.

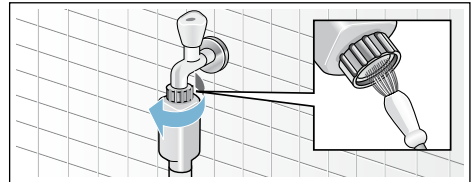

- For standard and Aqua-Secure models, clean the filter on the rear of the appliance: Remove the hose from the rear of the appliance. Use pliers to remove the filter and then clean it.

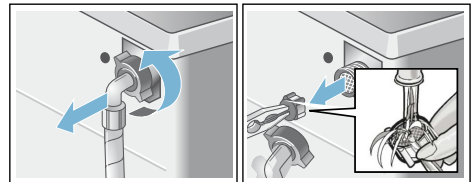

- Connect the hose and check for leaks.

## Faults and what to do about them.

### Emergency release

E.g. in the event of a power cut

The programme continues when the power supply is restored.

However, if the laundry has to be removed, the washing machine door can be opened as follows:

#### **Warning** **Risk of scalding!**

When you are washing at high temperatures, there is a risk of scalding if you come into contact with hot water and laundry.

If possible, leave it to cool down first.

#### **Warning** **Risk of injury!**

You may injure your hands if you reach into the drum while it is turning.

Do not reach into the drum when it is turning.

Wait until the drum has stopped turning.

#### **Caution!** **Water damage**







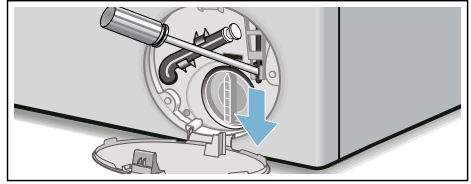





Any escaping water may cause water damage.

Do not open the door if water can be seen through the glass.

1. Switch off the appliance. Pull out the mains plug.
2. Drain the water. → *Page 56*
3. Pull the emergency release downwards with a tool and release. The door can then be opened.





## Information on the display panel



Display	Cause/remedy
Re-fill the i-DOS  ,  dispenser	The i-DOS dispensers are below the minimum fill level; top up → <i>Page 48</i> .
i-DOS  , i-DOS  error; deactivate i-DOS  , i-DOS 	set i-DOS  , i-DOS  to <b>off</b> . Call the after-sales service. The appliance can still be operated using manual dosing. Manual dosing → <i>Page 51</i>
Please close detergent drawer	Push the detergent drawer in correctly. → <i>Page 49</i>
Pause: Reload is not possible	Water level or temperature is too high. Press the  button to continue the programme.
Door cannot be unlocked: Water level or temperature is too high	Water level or temperature is too high. Press the  button to continue the programme.
The door cannot be locked; please open the door again, then close it and select the  button	<ul style="list-style-type: none"> <li>■ Laundry may be caught. Open and close the door again and press the  button.</li> <li>■ If necessary, push the door closed or remove some laundry and then push it closed again.</li> <li>■ If necessary, switch the appliance off and on again; set the programme and make your individual settings; start the programme.</li> </ul>
Please open tap	<ul style="list-style-type: none"> <li>■ Turn on the tap fully,</li> <li>■ Supply hose kinked/trapped,</li> <li>■ The water pressure is too low. Clean the filter. → <i>Page 57</i></li> </ul>
Please clean pump	<ul style="list-style-type: none"> <li>■ The drain pump is blocked. Clean the drain pump. → <i>Page 56</i></li> <li>■ The drain hose/drain pipe is blocked. Clean the drain hose at the siphon. → <i>Page 57</i></li> </ul>
AquaStop has been activated! Please call the after-sales service	Does not occur for models without AquaStop There is water in the base trough; the appliance is leaking. Turn off the tap. Call the after-sales service.
Auto power-off in ... seconds	Appliance automatically switches off after ... seconds if it is not operated for a prolonged period. To cancel, press any button. → <i>Page 52</i>
Water cooling	To protect the wastewater pipes, the hot detergent solution is cooled before being drained.



## en Faults and what to do about them.

Display	Cause/remedy
Drum care information:	This instruction reminds you to carry out the <b>Drum clean 90 °C</b> programme or a 60 °C programme to clean and care for the drum and the outer tub. <b>Notes</b> <ul style="list-style-type: none"> <li>■ Run the programme without laundry.</li> <li>■ Use washing powder or a detergent containing bleach. To prevent foaming, only use half the amount of detergent recommended by the detergent manufacturer. Do not use detergents designed for woollens or delicates.</li> <li>■ Switch reminder information on/off. → <i>Page 27</i></li> </ul>
Other displays Error E:XXX	Switch off the appliance, wait for five seconds and then switch it on again. If the display appears again, call the after-sales service.

## Faults and what to do about them.

Faults	Cause/remedy
Water is leaking from the appliance.	<ul style="list-style-type: none"> <li>■ Attach the drain hose correctly or replace it.</li> <li>■ Tighten the threaded joint on the inlet hose.</li> </ul>
The appliance is not filling with water.	<ul style="list-style-type: none"> <li>■ Have you pressed the <b>D00</b> button?</li> <li>■ Is the tap turned on?</li> <li>■ Could the filter be clogged? Clean the filter.</li> <li>■ Is the inlet hose kinked or trapped?</li> </ul>
The dispenser is empty and the fill level indicator is not flashing.	<ul style="list-style-type: none"> <li>■ Is the drawer cover/connector dirty? Cleaning → <i>Page 50</i></li> <li>■ Has the detergent drawer been pushed in correctly? Insert correctly. → <i>Page 55</i></li> </ul>
The wrong detergent/fabric softener has been poured into the dispenser(s).	Dispenser(s): <ol style="list-style-type: none"> <li>1. Empty and clean.</li> <li>2. Refill. → <i>Page 49</i></li> </ol>
Detergent/fabric softener has congealed in the dispensers.	Clean and refill the dispensers.
The door cannot be opened.	<ul style="list-style-type: none"> <li>■ The safety function is activated. Cancel the programme? → <i>Page 46</i></li> <li>■ Is the  childproof lock activated? Deactivate. → <i>Page 45</i></li> <li>■ Is  selected (Rinse Hold = no final spin)? → <i>Page 46</i></li> <li>■ Can the door only be opened by the emergency release? → <i>Page 58</i></li> </ul>
The programme will not start.	<ul style="list-style-type: none"> <li>■ Have you pressed the <b>D00</b> or <b>Finished in</b> button?</li> <li>■ Is the door closed?</li> <li>■ Is the  childproof lock activated? Deactivate. → <i>Page 45</i></li> </ul>
The drum briefly jerks or judders after the programme has started.	Not a fault – the internal motor test may cause the drum to jerk or judder briefly when the wash programme starts.

Faults	Cause/remedy
The water is not draining.	<ul style="list-style-type: none"> <li>■ Is  selected (Rinse Hold = no final spin)? → Page 46</li> <li>■ Clean the drain pump. → Page 56</li> <li>■ Clean the drain pipe and/or the drain hose.</li> </ul>
Water is not visible in the drum.	Not a fault – the water is below the visible area.
The spin result is not satisfactory. Laundry wet/too damp.	<ul style="list-style-type: none"> <li>■ Not a fault – the unbalanced load detection system has interrupted the spin cycle because the laundry is unevenly distributed. Distribute small and large items of washing in the drum.</li> <li>■ Is <b>Easy iron</b> selected (depending on the model)? → Page 49</li> <li>■ Is the selected speed too low? → Page 41</li> </ul>
The spin cycle runs several times.	Not a fault – the unbalanced load detection system is adjusting an imbalance.
The programme is taking longer than usual.	<ul style="list-style-type: none"> <li>■ Not a fault – the unbalanced load detection system is adjusting an imbalance by repeatedly distributing the laundry.</li> <li>■ Not a fault – the foam detection is system active – a rinse cycle has been switched on.</li> </ul>
The length of the programme changes during the wash cycle.	Not a fault – the programme sequence is optimised for the specific washing process. This may change the length of the programme shown on the display panel.
Residual water in the care-product compartment.	<ul style="list-style-type: none"> <li>■ Not a fault – the effectiveness of the care product is not affected.</li> <li>■ Clean the insert if necessary. → Page 44</li> </ul>
Odours in the washing machine.	<p>Run the <b>Drum clean</b> or <b>Cottons 90 °C</b> programme without laundry.</p> <p>Add washing powder or a detergent containing bleach.</p> <p><b>Note:</b> . To prevent foaming, only use half the amount of detergent recommended by the detergent manufacturer. Do not use detergents designed for woollens or delicates.</p>
Repeated, intensive foaming.	<ul style="list-style-type: none"> <li>■ Check the basic dosage settings and dosage strength.</li> <li>■ If required, use a different liquid detergent.</li> </ul>
Detergent/fabric softener drips off the seal and collects on the door or in the seal fold.	There is too much detergent/fabric softener in the dispensers. Observe the <b>max</b> markings in the dispensers.
i-DOS  default setting deleted.	All settings are changed when the menu setting <b>i-DOS  : Content</b> is changed. → Page 38
Loud noises, vibrations and machine “movement” during the spin cycle.	<ul style="list-style-type: none"> <li>■ Appliance aligned? Align the appliance. → Page 21</li> <li>■ Are the appliance feet secured? Secure the appliance's feet. → Page 21</li> <li>■ Have the transport braces been removed? Remove the transport braces. → Page 17</li> </ul>

Faults	Cause/remedy
The display panel/indicator lamps do not work while the appliance is running.	<ul style="list-style-type: none"> <li>■ Power failure?</li> <li>■ Have the fuses blown? Switch on/replace the fuses.</li> <li>■ If the fault occurs repeatedly, call the after-sales service.</li> </ul>
There is detergent residue on the laundry.	<ul style="list-style-type: none"> <li>■ Some phosphate-free detergents contain water-insoluble residue.</li> <li>■ Select <b>Rinse</b> or brush the laundry after washing.</li> </ul>
In the "Reload" status,  flashes very quickly and a signal sounds.	<ul style="list-style-type: none"> <li>■ The water level is too high. It is not possible to add laundry. Close the door immediately, if necessary.</li> <li>■ Press the  button to continue the programme.</li> </ul>
If you cannot rectify a fault yourself (after switching the machine off and on again) or a repair is required:	
<ul style="list-style-type: none"> <li>■ Switch off the appliance and pull out the mains plug.</li> <li>■ Turn off the tap and call the after-sales service.</li> </ul>	



## After-sales service

If you cannot rectify a fault yourself, contact customer services. → Cover page

We will always find an appropriate solution in order to avoid unnecessary visits by engineers.

Please give customer services the product number (E no.) and the production number (FD) of the appliance.

E-Nr. _____ FD _____
----------------------

E no.          Product number  
FD              Production number

You can find this information  
\*depending on the model:

On the inside of the door\*/in the opened service flap\* and on the rear of the appliance.

### Trust the expertise of the manufacturer.

Contact us for assistance. By doing so, you will ensure that the repairs are carried out by trained service personnel using genuine spare parts.



## Consumption rates

Model:	WM260162CN
Grade*	1
Power consumption (Kwh/cycle)	0.80
Water consumption (L/cycle)	64
Washing efficiency	1.03
Noise value**	
Maximum Spin value	69 dB(A)
Maximum Wash value	43 dB(A)
*Energy consumption tested under standard programme <b>Cottons 60 °C</b> , and additional function of <b>EcoPerfect @</b> , cancel i-DOS-function, according to GB12021.4.	
**Noise value tested according to GB19606.	



## Technical data

### Dimensions:

850 x 600 x 600 mm

(height x width x depth)

### Weight:

70 - 85 kg (depending on model)

### Mains connection:

Nominal voltage: 220 V, 50 Hz

Nominal current: 10 A

Nominal power: 2000 W

### Water pressure:

0.1 - 1 MPa (1 - 10 bar)

### Environmental conditions for use:

(according to GB/T 4288)

Ambient temperature: 0 °C - 40 °C, non-freezing;

Relative Humidity: less than 95% (at 25 °C), non-condensing



## Aqua-Stop warranty

### Only for appliances with Aqua-Stop

In addition to warranty claims against the vendor based on the purchase agreement and to our appliance warranty, we will provide compensation under the following conditions:

1. If water damage is caused due to a fault in our Aqua-Stop system, we will compensate domestic customers for the damage caused.
2. The liability guarantee is valid for the service life of the appliance.
3. It is a prerequisite of all warranty claims that the appliance with Aqua-Stop must have been installed and connected correctly in accordance with our instructions; this also includes a correctly fitted Aqua-Stop extension (genuine accessories). Our warranty does not cover defective feed lines or fittings leading to the Aqua-Stop connection at the tap.
4. Appliances with Aqua-Stop do not need to be supervised during operation, nor secured afterwards by turning off the tap. The tap only needs to be turned off if you are away from home for a long period, e.g. for several weeks' holiday.

## Gaggenau Hausgeräte GmbH

Carl-Wery-Straße 34

81739 München

GERMANY

[www.gaggenau.com](http://www.gaggenau.com)

9001359930 (9804)  
en



### Advice and repair order in the event of faults

GB 0344 892 8988 (Calls charged at local or mobile rate.)

IE 01450 2655 (0.03 € per minute at peak. Off peak 0.0088 € per minute.)

You can find the contact information for all countries in the attached after-sales service directory.



# GAGGENAU