

**Gaggenau**  
Instruction manual

# **CMP 250**

Fully Automatic Espresso Machine

---

## Table of contents

---

<b>Intended use</b>	<b>3</b>	<b>Daily care and cleaning</b>	<b>23</b>
<b>Important safety information</b>	<b>3</b>	Daily maintenance	23
<b>Environmental protection</b>	<b>4</b>	Cleaning the milk system	24
Saving energy	4	Cleaning the brewing unit	25
Environmentally-friendly disposal	4	<b>Service programmes</b>	<b>26</b>
<b>Familiarising yourself with your appliance</b>	<b>5</b>	Cleaning	26
Included in delivery	5	Descaling	27
Assembly and components	6	Cleaning and descaling	27
Display and operating controls	7	<b>Emptying programme</b>	<b>28</b>
Function selector positions	7	<b>Simple troubleshooting</b>	<b>29</b>
Symbols	7	<b>Technical data</b>	<b>31</b>
Colours and display	8		
Door opening	8		
Additional information <b>i</b> and <b>i</b> <sup>®</sup>	8		
Accessories	9		
<b>Switching the appliance on and off</b>	<b>9</b>		
Main switch	9		
Hibernate mode	10		
Activating the appliance	10		
<b>Setting up the appliance</b>	<b>10</b>		
Initial settings	10		
Setting the water hardness	11		
<b>Water filter</b>	<b>11</b>		
Operation with or without a water filter	11		
Inserting the water filter	12		
<b>Filling the water tank and bean container</b>	<b>12</b>		
<b>Preparing beverages</b>	<b>13</b>		
Beverage selection	13		
Preparing coffee using freshly ground beans	14		
Preparing two cups at the same time	14		
Preparing coffee using ground coffee	15		
Preparing a coffee with milk	15		
Preparing milk froth and warm milk	16		
Preparing hot water	16		
Setting the grinding level	17		
Changing bean type	17		
<b>Individual beverages</b>	<b>18</b>		
<b>Child lock</b>	<b>19</b>		
Activating the child lock	19		
Deactivating the child lock	19		
<b>Basic settings</b>	<b>20</b>		
Setting the milk container weight	22		
Messages	22		

Additional information on products, accessories, replacement parts and services can be found at [www.gaggenau.com](http://www.gaggenau.com) and in the online shop [www.gaggenau.com/zz/store](http://www.gaggenau.com/zz/store)

## Intended use

Check the appliance for damage after unpacking it. Do not connect the appliance if it has been damaged in transport.

This appliance is intended for domestic use only.

Only use the appliance indoors at room temperature and up to 2000 m above sea level.

Protect the appliance from frost, otherwise it will become damaged.

## Important safety information

Please read carefully, follow and retain the operating instructions. When passing on the appliance, enclose these instructions.

This appliance can be used by children aged from 8 years and above and by persons with reduced physical, sensory or mental capabilities or lack of experience and knowledge if they have been given supervision or instruction concerning use of the appliance in a safe way and if they understand the hazards involved. Keep children under 8 years of age away from the appliance and connecting cable and do not allow them to use the appliance. Children shall not play with the appliance. Cleaning and user maintenance shall not be made by children unless they are older than 8 years and supervised.

### Warning – Danger of electric shock!

- The appliance may only be connected to a power supply with alternating current via a correctly installed socket with earthing. Ensure that the protective conductor system of the domestic electricity supply has been correctly installed.
- Connect and operate the appliance only in accordance with the specifications on the rating plate. If the power cord of this appliance is damaged, it must be replaced by customer service.
- Do not use if the power cable or appliance is damaged. If a fault occurs, pull the mains plug or switch off the mains voltage immediately.
- To prevent hazards, the appliance may be repaired by our customer service only.
- Never immerse the appliance or mains cord in water.

### **⚠ Warning – Hazard due to magnetism!**

The appliance contains permanent magnets which may affect electronic implants, e.g. heart pacemakers or insulin pumps. Persons wearing electronic implants must maintain a minimum distance of 10 cm from the appliance and from the following parts upon removal: milk container, milk system, water tank and brewing unit.

### **⚠ Warning – Risk of suffocation!**

Do not let children play with packaging material. Store small parts safely as they can be easily swallowed.

### **⚠ Warning – Risk of burns!**

The milk system becomes very hot. After use, allow it to cool down first before touching it.

### **⚠ Warning – Risk of injury!**

- Improper use of this appliance may result in injury.
- Do not reach into the grinding unit.
- Be careful not to jam your fingers when closing the door.

---

## **Environmental protection**

---

### **Saving energy**

- If the appliance is not being used, switch it off.
- Set the interval for automatic switch-off to the smallest value.
- If possible, do not interrupt coffee or milk froth dispensing. Stopping a process prematurely results in higher energy consumption and the drip tray fills up more quickly.
- Descale the appliance regularly to avoid a build-up of limescale. Limescale residue results in higher energy consumption.

### **Environmentally-friendly disposal**

Dispose of packaging in an environmentally-friendly manner.



This appliance is labelled in accordance with European Directive 2012/19/EU concerning used electrical and electronic appliances (waste electrical and electronic equipment - WEEE). The guideline determines the framework for the return and recycling of used appliances as applicable throughout the EU.

Please ask your dealer about current disposal routes.

## Familiarising yourself with your appliance

Use this section to familiarise yourself with your new appliance. The control panel and the individual operating controls are explained. You will also be informed about the accessories.

Further information about the appliance, such as how to change the opening angle of the door, can be found in the enclosed installation instructions.

### Included in delivery

(For use)

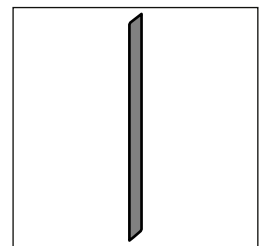
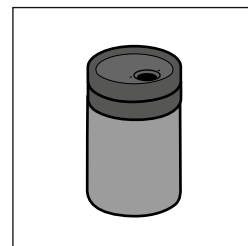
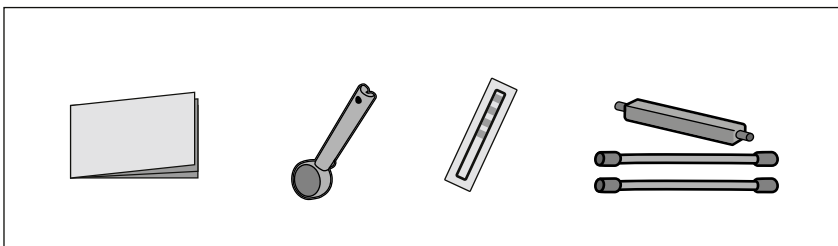
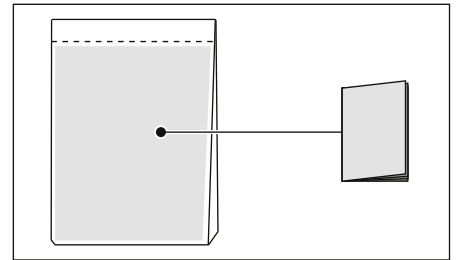
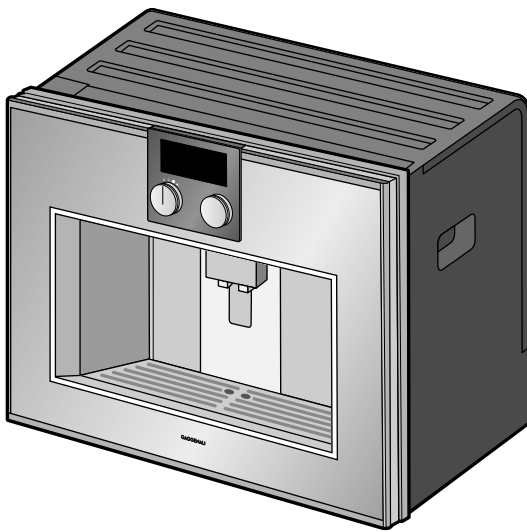

## Assembly and components

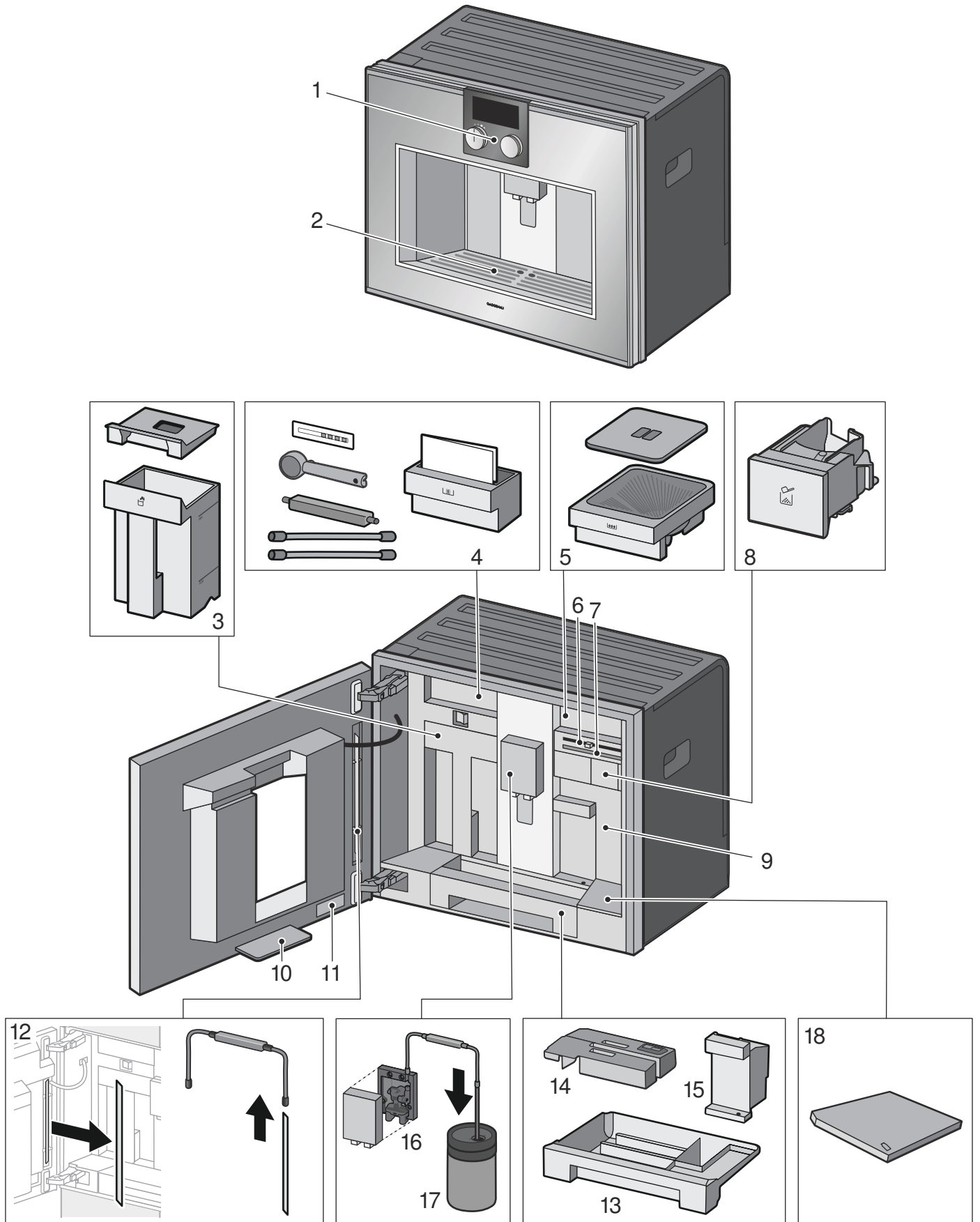

1	Display and controls
2	Shelf, e.g. for a cup
3	Water tank with cover
4	Accessory drawer (for quick reference guide and accessories)
5	Bean container
6	Grinding level adjustment
7	Magnetic holder (for milk hose connecting element)
8	Ground coffee drawer
9	Protective cover (for brewing unit)
10	Collecting tray
11	Rating plate
12	Holder (for milk tube)
13	Drip tray
14	Drip tray cover
15	Coffee residue container
16	Beverage dispenser and milk system, height-adjustable
17	Milk container
18	Shelf (scales) for milk container, removable

## Display and operating controls

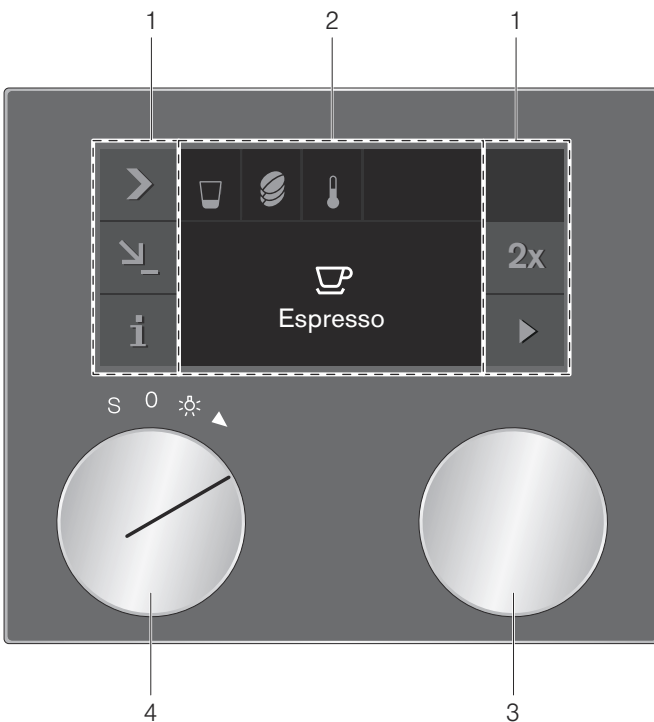

1	Control panel	These areas are touch sensitive. Touch a symbol to select the corresponding function.
2	Display	The display shows, for example, current settings and options.
3	Rotary selector	You can select the desired beverage and other settings using the rotary selector.
4	Function selector	You can use the function selector to call up beverages or the favourite drinks you have saved.

## Function selector positions

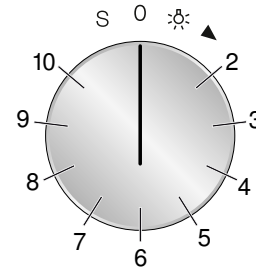

Position	Function
0	Zero setting
☀	Light
2	Beverage selection
3 - 10	Memory locations for individual beverages
S	Service programmes/basic settings

## Symbols

The following overview details the symbols that are the most used when operating the appliance.

Symbol	Function
▶	Start
■	Stop
✕	Cancel
✓	Confirm/save settings
>	Selection arrow
i	Call up additional information
💬	Call up additional tips
↙	Edit settings
↘	Save individual beverage
🗑️	Quick capacity selection
2x	2 beverages
🔒	Child lock

## Colours and display

### Colours

The different colours are used to guide the user in the relevant setting situations.

Orange	Initial settings Main functions, messages
Blue	Basic settings Cleaning
White	Adjustable values

### Appearance

The symbols, values and displays may change, depending on the situation.

Standard	Values and symbols which have just been selected will be displayed in a larger font.
Reduced display screen	After a short while, the amount of information shown on the display will be reduced and only the most important information will remain. This function is activated in the basic settings ex works and can be deactivated.

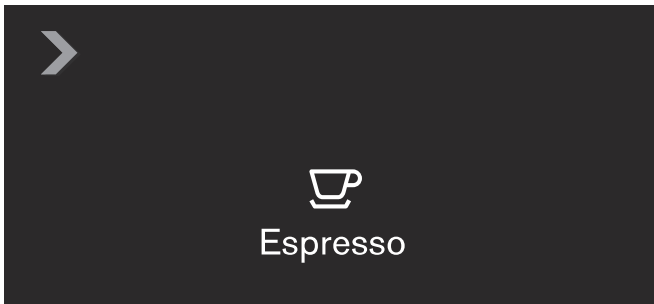

## Door opening

You can open the recessed handle on the side by hand.

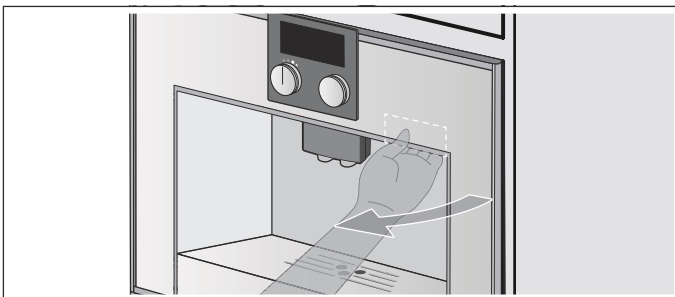

## Additional information i and i<sup>!</sup>

By touching the **i** symbol you can call up additional information.

During operation you will for example receive information about the number of beverages dispensed previously.

If the function selector is set to **S**, you will for example receive information about when the appliance needs to be descaled or cleaned, or when the water filter needs changing. You can use this information for example to start a service programme that is due soon.

The **i<sup>!</sup>** symbol appears for important user prompts. New messages are also shown on the display for several seconds. These messages disappear automatically after a few seconds or must be confirmed with **✓**. A list of messages can be displayed by touching the **i<sup>!</sup>** symbol. The message disappears when the required action has been carried out.



## Accessories

The fully automatic espresso machine has a drawer for storing accessories such as the quick reference guide or measuring spoon inside the appliance. After opening the door, you can use the magnetic holder and the clip for the individual parts, such as the milk hose set. The holder for the milk tube is situated on the inside of the door.

The appliance includes the following accessories as standard:

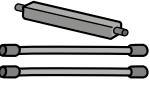
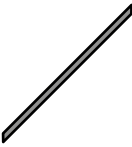
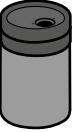
	<p><b>Measuring spoon</b> For adding ground coffee.</p>
	<p><b>Milk hose set</b> For connecting the milk container.</p>
	<p><b>Milk tube</b> For inserting into the milk container, milk cartons and milk bottles or for running a service programme.</p>
	<p><b>Milk container</b> Volume capacity 0.5 litres. The milk container has been designed especially for use together with this fully automatic coffee machine. It is intended solely for use in the household and for storing milk in the refrigerator.</p>

The following accessories can be ordered by contacting the after-sales service:

- Water filter (order no.: 17000705)
- Cleaning tablets (order no.: 00311769)
- Descaling tablets (order no.: 00311819)
- Stainless-steel milk container (order no.: 11005967)
- Limit stop for 92° opening angle (order no.: 00636455)
- Bean container with lid (order no.: 11015223)

## Switching the appliance on and off

### Main switch

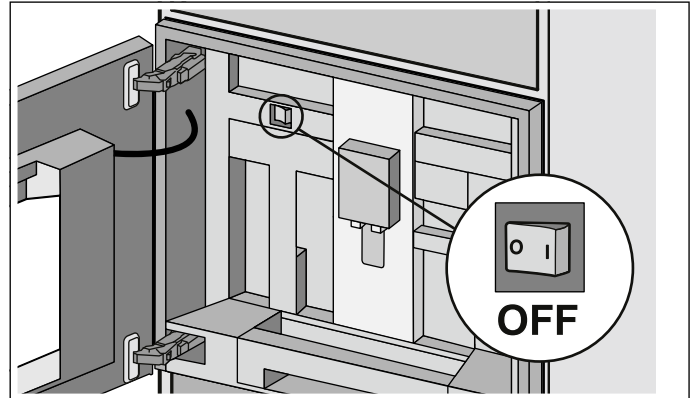

The main switch is used to switch the appliance on and off.

If the appliance is switched off at the main switch, the power supply is interrupted.

The appliance is programmed so that it switches to standby mode automatically after about 30 minutes. This timespan can be changed. → "Basic settings" on page 20

The appliance rinses automatically when it is switched on at the main switch. Exception: The appliance was only switched off a few minutes beforehand.

### Notes

- Do not press the main switch during operation. If you want to manually switch off the appliance, you must first set the function selector to **0** so that it rinses automatically. Then switch off the appliance using the main switch.
- The appliance is equipped with a sensor. If a milk container is present, this will be shown on the display when switching to energy-saving mode (function selector set to **0**). If there is milk in the container, please keep in the refrigerator.

## Hibernate mode

The appliance goes into hibernate mode if the function selector is turned to **0** or if the child lock is activated.

The brightness of the display is dimmed in hibernate mode during the first few minutes.



The display then switches itself off.

### Notes

- In Basic settings, you can select whether the Gaggenau logo is to be displayed during hibernate mode. → "Basic settings" on page 20
- The brightness of the display depends on the vertical viewing angle. You can adjust the display using the "Brightness" setting in the basic settings.

## Activating the appliance

To leave hibernate mode or to activate the display when it has been switched off, turn the function selector.

You can now set the desired function. You can read about how to set functions in the respective chapters.

**Note:** If no drip tray is inserted, the appliance cannot be switched on and no water will flow from the coffee dispenser.

The message "Insert trays" appears.

---

## Setting up the appliance

---

**Note:** Only use the appliance in frost-free areas. If the appliance was transported or stored at temperatures below 0 °C, you must wait for at least 3 hours before using it.

Before the appliance can be switched on and used, it must be assembled and connected according to the enclosed installation instructions.

## Initial settings

### Notes

- The query appears automatically when first switched on after connection to a power outlet.
  - You can change the settings at any time. → "Basic settings" on page 20
- 1 Switch on the appliance at the main switch. The preset language appears in the display.

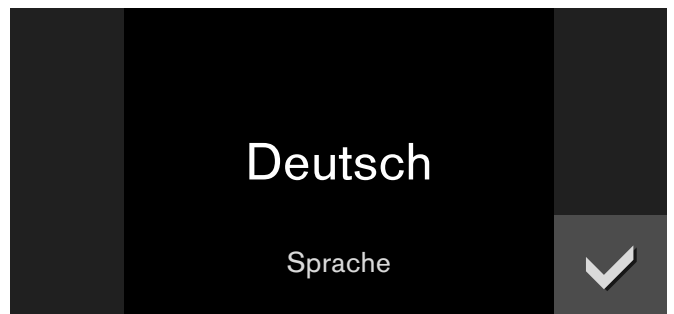

- 2 Turn the rotary selector to select the required display language.
- 3 Press ✓ to confirm. The temperature unit appears in the display.
- 4 Use the rotary selector to select the required temperature unit.
- 5 Press ✓ to confirm. The preset capacity unit appears in the display.
- 6 Use the rotary selector to select the required capacity unit.
- 7 Press ✓ to confirm. The preset weight unit appears in the display.
- 8 Use the rotary selector to select the required weight unit.
- 9 Press ✓ to confirm.

The display shows "Initial set-up complete".. Confirm with ✓. The appliance is now ready to use.

**Note:** If the language is changed, the system restarts. This takes a few seconds.

## Setting the water hardness

It is important to set the water hardness correctly so that the appliance indicates in good time when the descaling programme should be run. The preset water hardness is level 4. If a water softening unit is installed in the household, select the "Softening device" setting. You can check the water hardness using the enclosed test strip or by asking your local water supplier.

- 1 Briefly immerse the enclosed test strip in fresh tap water, leave it to drip and read off the result after one minute.
- 2 Rotate the function selector to **S**.
- 3 Use the rotary selector to select "Basic settings" and touch the ✓ symbol.
- 4 Use the rotary selector to select "Water hardness".
- 5 Touch the ↵ symbol.
- 6 Using the rotary selector, set the measured water hardness.
- 7 Press ✓ to confirm.

The setting has been saved. Touch ✕ to exit the basic settings.

---

## Water filter

---

### Operation with or without a water filter

You can use the appliance with or without a water filter. To ensure that the descaling display of the appliance functions correctly, you must specify in the basic settings whether a water filter is used.

- 1 Rotate the function selector to **S**.
- 2 Select "Basic settings" using the rotary selector.
- 3 Touch the ✓ symbol.
- 4 Select "Water filter" using the rotary selector.
- 5 Touch the ↵ symbol.
- 6 Use the rotary selector to select either "Available" (with water filter) or "Not available" (without water filter).
- 7 Press ✓ to confirm.  
The rinse program starts with the "Available" setting. Proceed according to the information on the display.
- 8 Touch the ✕ symbol to leave the Basic settings menu.

## Inserting the water filter

New water filters must always be rinsed after being fitted.

- 1 Rotate the function selector to **S**.
- 2 Select "Water filter change" using the rotary selector.
- 3 Touch the ✓ symbol.
- 4 Fit the water filter in the water tank and then fill the tank with water up to the "max" mark.

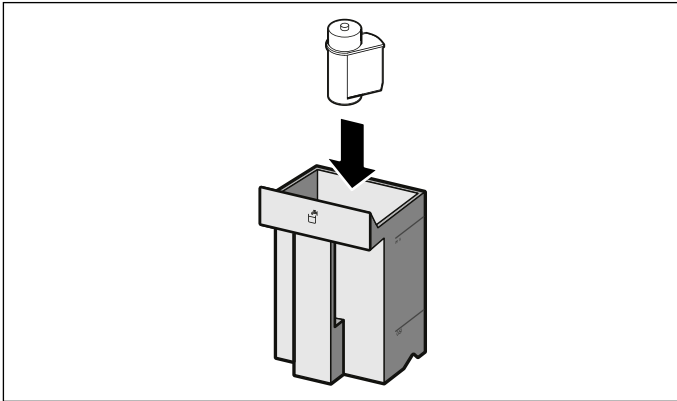

- 5 Remove the milk hose from the milk container and close the door.
- 6 Place a 0.5-litre container under the coffee dispenser.
- 7 Touch the ✓ symbol.

The water first runs through the filter to rinse it and then into the container. After the rinsing process, confirm with ✓ and empty the container. The appliance is again ready for use.

Rinsing the filter also activates the setting for the "Change water filter" display. When the display "Please change water filter" is shown, or at the latest after two months, the filter is no longer effective. It needs to be replaced for reasons of hygiene and so that the appliance does not experience a build-up of limescale (which could damage the appliance).

Replacement filters can be obtained from the after-sales service. → "Accessories" on page 9

**Note:** If the appliance has not been used for a long period of time (due to holidays, for example), the filter that is fitted should be rinsed before using the appliance. To do this, simply dispense a cup of hot water.

---

## Filling the water tank and bean container

---

Using your appliance, you can prepare coffee using freshly ground coffee beans or ground coffee. Always only add ground coffee shortly before making a drink. → "Preparing coffee using ground coffee" on page 15

- 1 Open the door.
- 2 Remove the water tank and fill it with fresh, still, cold water. Reinsert the water tank.

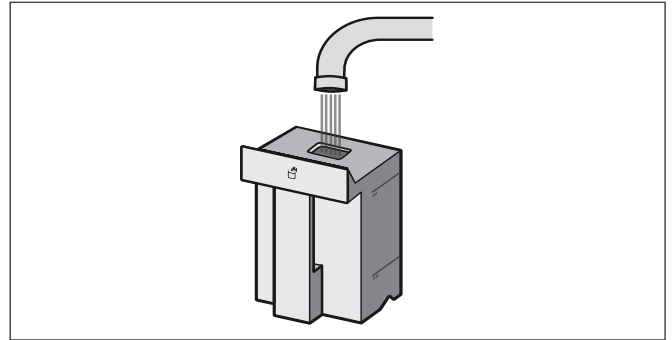

- 3 Pull the bean container out, remove the lid and fill the container with beans. Replace the lid and insert the bean container again.

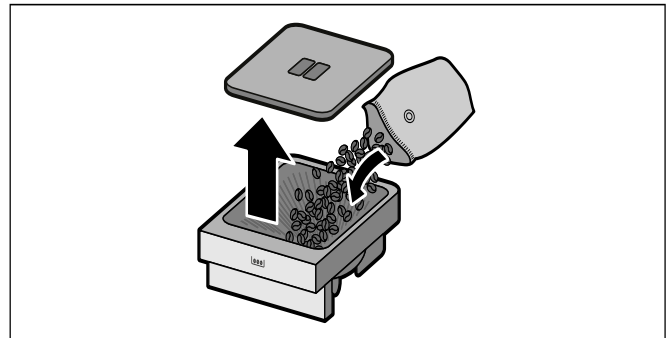

**Note:** Coffee beans that have been glazed or caramelised or that contain other sugary additives block the brewing unit. Only use pure bean mixes that are suitable for use in fully automatic espresso or coffee machines.













- 4 Close the door.

## Preparing beverages





### Beverage selection

#### Notes

- The integrated fan switches on each time a drink is dispensed and switches off again after a few minutes.
- When first using the appliance or when it has not been used for a long time, the first cup of coffee does not have the full aroma.
- The appliance is programmed with the standard factory settings for optimal performance.
- After starting the appliance for the first time, you will only consistently achieve a suitably thick and stable crema after the first few cups have been dispensed.

	Ristretto	Concentrated espresso. Best served in small, thick-walled cups. Preheat cups with hot water.
	Espresso	Concentrated coffee. Serve in small, thick-walled cups. Preheat cups with hot water.
	Coffee	Coffee
	Americano	1/3 espresso, is topped up with 2/3 hot water.
	Hot water	For preparing hot drinks, e.g. tea, or to preheat cups.
	Milk froth	For preparing speciality white coffees.
	Warm milk	As a beverage or as an ingredient in special coffee beverages.
	White coffee	1/2 coffee + 1/2 milk; best served in a wide-rimmed cup.
	Latte Macchiato	A specialty drink, served in a glass featuring three layers: at the bottom hot milk, in the middle espresso, and at the top milk froth.
	Flat White	Espresso with frothed milk.
	Cappuccino	1/3 espresso + 1/3 milk + 1/3 milk froth; best served in a cup.
	Espresso Macchiato	Espresso finished with milk froth.

You may be able to select further options depending on your choice of beverage:

	Size	Small - Medium - Large - Very large
	Strength	Very mild - Mild - Medium - Strong - Very strong - Extra strong etc., not available for milk froth, warm milk and hot water
	Temperature	Hot - Very hot - Extra hot not available for milk froth and warm milk Different temperatures can be selected for hot water.
	Mixing ratio	Setting for the proportion of milk, only available for coffee beverages with milk.

#### Aroma function "Extra strong"

The longer coffee is brewed, the more bitter substances and undesired aromas are released. This has a negative effect on the taste and makes the coffee less easily digestible. Your appliance therefore has a special Aroma function for very strong coffee. After half the requested volume has been prepared, coffee is ground and brewed once more, so that only the palatable and easily digestible flavours are released.

The Aroma function "Extra strong", e.g. "Extra strong 3 ☉ 2x" is only available for certain settings. The coffee is prepared in two stages with this setting. Wait until the process is fully completed.

## Preparing coffee using freshly ground beans

The appliance must be switched on. The water tank and bean container must be filled.

- 1 Rotate the function selector to position 2.

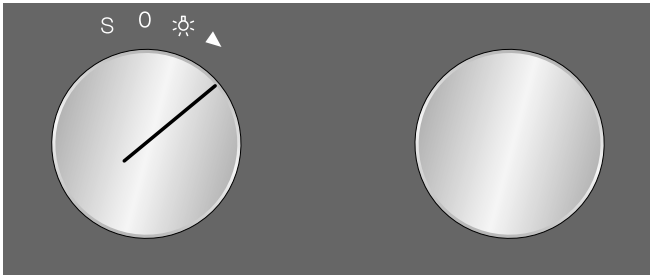

- 2 Use the rotary selector to select the desired beverage, e.g. coffee.

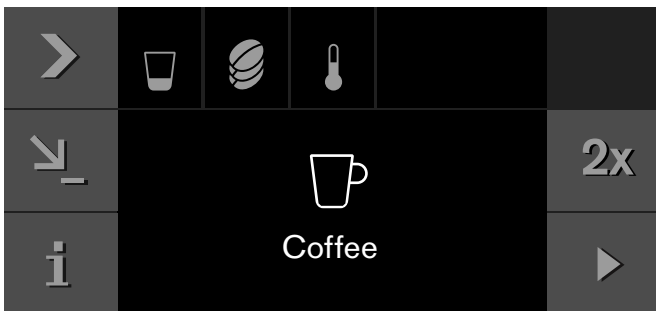

- 3 Place a cup under the coffee dispenser.
- 4 Touch the > symbol.
- 5 Set the size using the rotary selector.

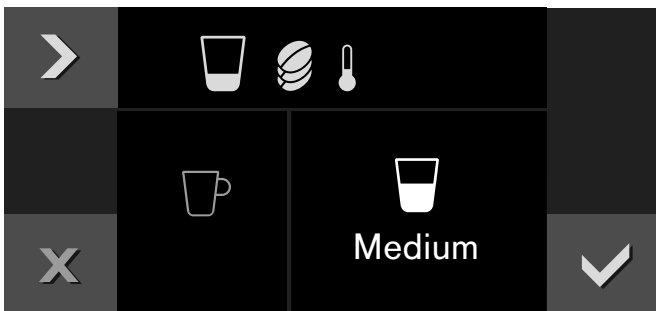

- 6 Touch the > symbol.
- 7 Set the strength using the rotary selector.

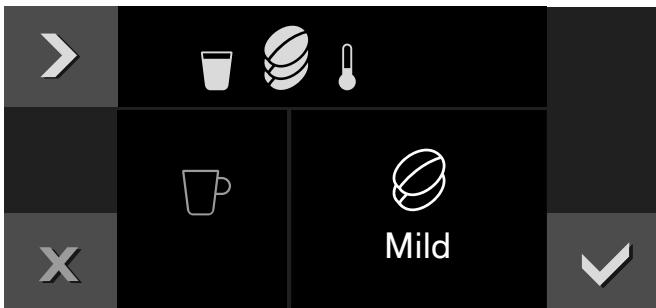

- 8 Touch the > symbol.

- 9 Set the temperature using the rotary selector.

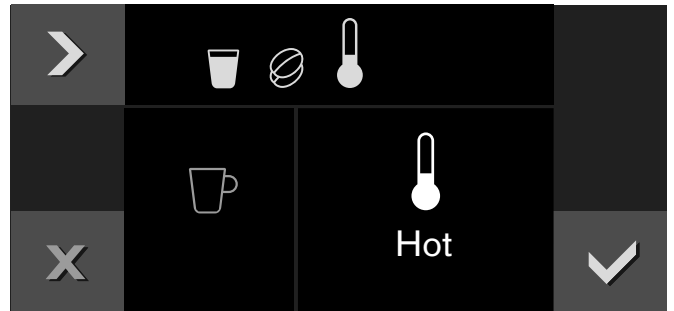

- 10 Press ✓ to confirm the settings.

- 11 Press ▶ to start.

The beverage is brewed and then runs into the cup.

### Notes

- While the beverage is dispensed, the ■ symbol is displayed. Touch this symbol to stop the beverage being prepared.
- Using the ↵ symbol, you can save the current beverage: Touch the ↵ symbol, turn the function selector to a free memory location and save the entry. → "Individual beverages" on page 18

## Preparing two cups at the same time

You have the option of dispensing two beverages simultaneously:

- 1 Select the beverage and use the rotary selector to choose settings such as the temperature if desired.
- 2 Touch the 2x symbol.
- 3 Place two cups, or similar, underneath the beverage dispenser.
- 4 Press ▶ to start.

The beverage selected is brewed and then dispensed into the cups.

**Note:** The coffee is prepared in two stages. Wait until the process is fully completed.

## Preparing coffee using ground coffee

The appliance must be switched on and the water tank must be filled.

**Important:** Remove cups or glasses before opening the door as they may otherwise fall off.

- 1 Turn the function selector to position 2.
- 2 Open the door.
- 3 Using the measuring spoon, fill a maximum of two level spoonfuls of ground coffee into the ground coffee drawer. Close the ground coffee drawer.

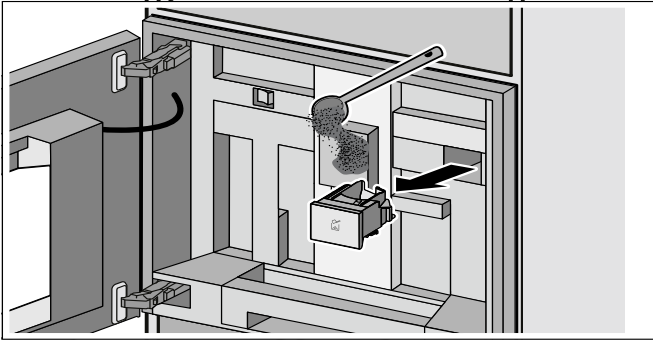

**Note:** Do not fill the drawer with beans or instant coffee.

- 4 Close the door.
- 5 Use the rotary selector to select the desired beverage (beverages made from ground coffee are identified with the ☐ symbol).
- 6 Place a cup under the coffee dispenser.
- 7 Touch the ▶ symbol.
- 8 Set the quantity using the rotary selector.
- 9 Touch the ▶ symbol.
- 10 Set the temperature using the rotary selector.
- 11 Confirm the settings using ✓.
- 12 Press ▶ to start.

The beverage is brewed and then runs into the cup. To prepare another cup, refill with ground coffee and repeat the process.

### Notes

- While the beverage is dispensed, the ■ symbol is displayed. Touch this symbol to stop the beverage being prepared.
- If coffee is not dispensed within 90 seconds, the brewing chamber empties itself automatically to prevent an overflow.
- The Aroma function is unavailable when using ground coffee. Similarly, it is not possible to dispense two cups at once when using ground coffee.

## Preparing a coffee with milk

### ⚠ Warning – Risk of burns!

The milk system becomes very hot. After use, allow it to cool down first before touching it.

You can decant the milk into the milk container supplied or fill e.g. into a milk jug or use the milk directly from the carton. → "Setting the milk container weight" on page 22

**Important:** Remove cups or glasses before opening the door as they may otherwise fall off.

### Using the milk container:

- Open the door.
- Push the beverage dispenser down completely.
- Remove the cover of the beverage dispenser towards the front.
- Attach a milk hose from the milk system to the beverage dispenser and feed it outwards through the opening at the top.
- Attach the connecting element of the milk system to the magnetic holder (on the inside of the appliance).
- Place the filled milk container on the right next to the coffee dispenser. Connect the milk tube to the milk hose and then guide the milk tube into the milk container. The end of the milk tube must be immersed in the milk.

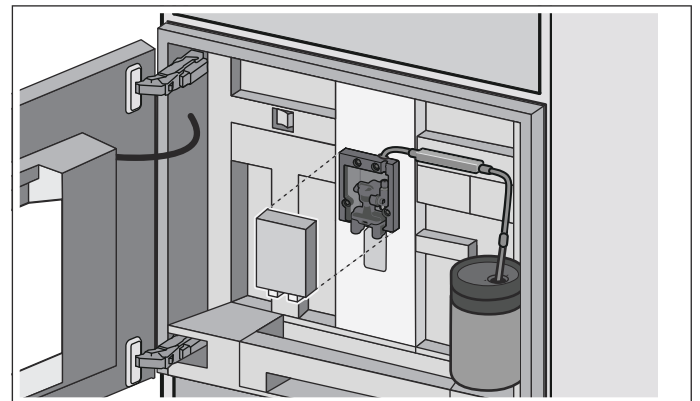

- Close the door.

#### Using a milk carton or other container:

- Open the door.
- Push the beverage dispenser down completely.
- Remove the cover of the beverage dispenser towards the front.
- Feed the milk hose of the milk system outwards through the opening at the top.
- Attach the magnetic holder to the appliance.
- Place the filled milk carton on the right next to the coffee dispenser. Connect the milk tube to the milk hose and then guide the milk tube into the milk carton. The end of the milk tube must be immersed in the milk.
- Close the door.

To prepare a drink:

The appliance must be switched on. The water tank and bean container must be filled.

- 1 Rotate the function selector to position 2.
- 2 Using the rotary selector, select a coffee beverage with milk. To select a beverage made with ground coffee, you must first fill the ground coffee drawer.
- 3 Place a cup or glass under the coffee dispenser.
- 4 Press ▶ to start.  
- or -  
Touch the > symbol first, then set the size or strength for example, using the rotary selector. Confirm with ✓.

The milk is drawn in and prepared and then the coffee is brewed.

#### Notes

- While the beverage is dispensed, the ■ symbol is displayed. Touch this symbol to stop the beverage being prepared.
- Using the ↘ symbol, you can save the current beverage: Touch the ↘ symbol, turn the function selector to a free memory location and save the entry. → "Individual beverages" on page 18
- Dried-on milk residues are difficult to remove, so always clean the milk system after every use. → "Cleaning the milk system" on page 24

## Preparing milk froth and warm milk

### ⚠ Warning – Risk of burns!

The milk system becomes very hot. After use, allow it to cool down first before touching it.

To prepare a drink:

The appliance must be switched on.

- 1 Rotate the function selector to position 2.
- 2 Connect the milk hose. → "Preparing a coffee with milk" on page 15
- 3 Select "Milk froth" or "Warm milk" with the rotary selector.
- 4 Place a cup or glass under the coffee dispenser.
- 5 Touch the > symbol.
- 6 Set the size using the rotary selector.
- 7 Press ✓ to confirm the settings.
- 8 Press ▶ to start.

The milk is drawn in and then flows into the cup or glass.

#### Notes

- While the beverage is dispensed, the ■ symbol is displayed. Touch this symbol to stop the beverage being prepared.
- Using the ↘ symbol, you can save the current beverage: Touch the ↘ symbol, turn the function selector to a free memory location and save the entry. → "Individual beverages" on page 18
- Dried-on milk residues are difficult to remove, so always clean the milk system after every use. → "Cleaning the milk system" on page 24

## Preparing hot water

### ⚠ Warning – Risk of burns!

The milk system becomes very hot. After use, allow it to cool down first before touching it.

The appliance must be switched on and the water tank filled.

- 1 Remove the milk hose from the milk container.
- 2 Rotate the function selector to position 2.
- 3 Select "Hot water" using the rotary selector.
- 4 Place a cup or glass under the coffee dispenser.
- 5 Touch the > symbol.
- 6 Set the size using the rotary selector.
- 7 Touch the > symbol.
- 8 Set the temperature using the rotary selector.
- 9 Press ✓ to confirm.
- 10 Press ▶ to start.

The water is heated and then flows into the cup or glass.



## Notes

- While the beverage is dispensed, the ■ symbol is displayed. Touch this symbol to stop the beverage being prepared.
- Using the ↘ symbol, you can save the current beverage: Touch the ↘ symbol, turn the function selector to a free memory location and save the entry. → "Individual beverages" on page 18

## Setting the grinding level

### ⚠ Warning – Risk of injury!

Do not reach into the grinding unit.

Using the slider for the grinding level, the desired fineness of the ground coffee can be set between a fine grinding level (left) and a coarser grinding level (right).

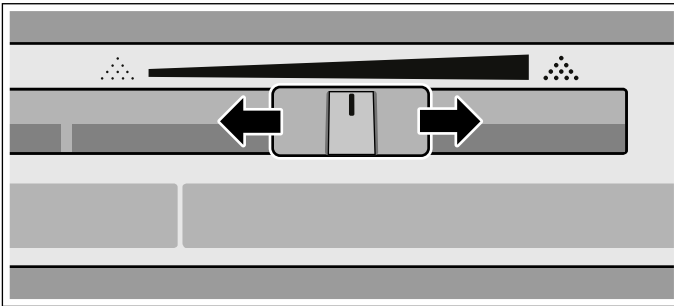

## Notes

- The new setting only becomes noticeable after the second cup of coffee.
- Set a finer grinding level with dark-roasted beans and a coarser grinding level with lighter beans.
- If the display shows the message "Set coarser grinding level", the coffee beans are being ground too finely. Set a coarser grinding level. To do so, slide the slider to the right.
- Only make small changes to the grinding level setting.

## Changing bean type

If you are using a new type of bean, the Empty grind function allows you to run the grinding unit until empty of your previous bean type.

The appliance must be switched on.

- 1 Remove the bean container and empty out the beans.
- 2 Add the new beans and reinsert the bean container. The message "New type of coffee beans in bean container?" appears.
- 3 Press ✓ to confirm.

The grinding unit is then emptied of your previous bean type in two grinding stages.

**Note:** This message always appears when the bean container is inserted. If you do not want to empty the grinding unit, e.g. when only refilling with beans, confirm with X.

## Individual beverages

You can define and save instructions for up to 8 individual beverages.

- 1 Turn the function selector to one of the 8 memory locations.

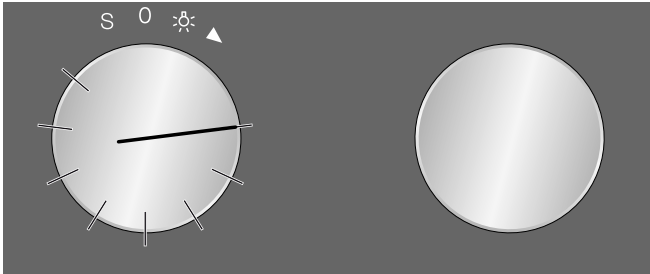

- 2 Use the > symbol to successively select the desired beverage, size, strength, temperature and coffee-milk ratio and use the rotary selector to save the settings.



- 3 Enter the name of the beverage in "ABC".

Rotary selector	Selects letters A new word always begins with a capital letter.
>A <sup>ä</sup>	Press briefly: moves the cursor to the right Press and hold: shifts to umlauts and special characters Press twice: adds a line break
>Ä	Press briefly: moves the cursor to the right Press and hold: shifts to normal characters Press twice: adds a line break
⌫	Delete letters

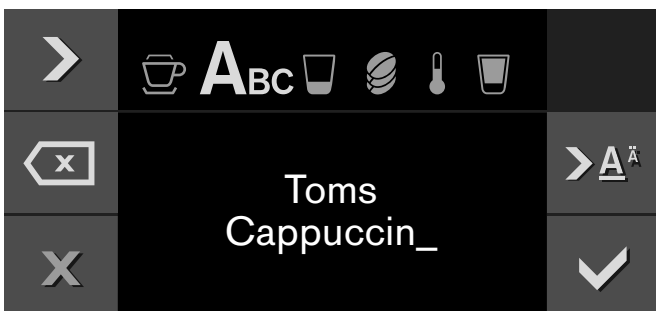

- 4 Save with ✓ or cancel with X and exit the menu.

- 5 Press ▶ to start.

Depending on the beverage selected, the beans will be ground first, then the milk prepared and finally the coffee brewed.

### Notes

- While the beverage is dispensed, the ■ symbol is displayed. Touch this symbol to stop the beverage being prepared.
- For entering a name, Latin characters, certain special characters and numbers are available.
- To change an existing memory location, touch the ⌫ symbol and save a new setting.
- If a memory location which is already occupied is selected, the settings will be overwritten.

---

## Child lock

---

The appliance has a child lock to prevent children operating it accidentally.

### Notes

- You must set the child lock to "Available" in Basic settings. → *"Basic settings" on page 20*
- If there is a power failure while the child lock is activated, it may be deactivated when power is restored.

## Activating the child lock

### Prerequisite:

The function selector is set to 0.

Touch the  symbol for at least 6 seconds.



The child lock is now activated. The  symbol is shown at the top of the display.

## Deactivating the child lock

### Prerequisite:

The function selector is set to 0.

Touch and hold the  symbol for at least 6 seconds.





The child lock is deactivated. You can set the appliance as normal.















## Basic settings









Your appliance can be individually adjusted in the basic settings.

- 1 Turn the function selector to **S**.
- 2 Select "Basic settings" using the rotary selector.
- 3 Touch the  symbol.
- 4 Turn the rotary selector to select the required basic setting.

- 5 Touch the  symbol.
- 6 Set the basic setting using the rotary selector.
- 7 Save with  or cancel with  and exit the current basic setting.
- 8 Turn the function selector to **0** to exit the basic settings menu.

The changes are saved.

	Basic setting	Permitted settings	Explanation
	Brightness	Level 1, 2, 3, 4, 5*, 6, 7, 8	Sets the display brightness
	Hibernate mode	with logo*/without logo	Hibernate mode display with or without GAGGENAU logo
	Display	Reduced*/Standard	If the 'Reduced' setting has been selected, only the most important information will be shown on the display after a short time.
	Touch field colour	Grey* / White	Selects the colour of the symbols on the touch fields
	Touch field tone	Tone 1* / Tone 2 / Off	Selects an audible signal for when a touch field is touched
	Touch field tone volume	Level 1, 2, 3, 4, 5*, 6, 7, 8	Sets the volume of the touch field tone
	Signal volume	Level 1, 2, 3, 4, 5*, 6, 7, 8	Sets the volume of the audible signal
	Light settings	Lighting options 1*-7	<ul style="list-style-type: none"> <li><input type="radio"/> Light off</li> <li><input checked="" type="radio"/> Light on</li> <li><input type="checkbox"/> Light only on when a beverage is being dispensed</li> </ul> Other setting options will appear if you touch the  symbol.
	Standby after	5 minutes - 12 hours	Setting for the time after which the appliance automatically rinses and switches to standby mode.
	Water hardness	1-4*, softening device	Briefly immerse the enclosed test strip in fresh tap water, leave it to drip and read off the result after one minute. Set the measured water hardness.
	Water filter	Available/not available*	Available: Operating the appliance with a water filter.  Not available: Operating the appliance without a water filter.
	Temperature format	°C* / °F	Sets the temperature unit
	Capacity unit	ml/fl.oz.*	Set the capacity unit

	Capacity	+ / 5 ml to 60 ml (0.2 fl.oz to 2 fl.oz)	Adjust the capacity to individual cup sizes. First select the beverage and then set the capacity.
	Weight unit	g*/oz.	Set the weight unit
	Milk container weight	Standard*/Individual	Setting for weight detection. → "Setting the milk container weight" on page 22
	Language	German* / French / Italian / Spanish / Portuguese / Dutch / Danish / Swedish / Norwegian / Finnish / Greek / Turkish / Russian / Polish / Czech / Slovenian / Slovakian / Arabic / Hebrew / Japanese / Korean / Thai / Chinese / English US / English	Select language for text display <b>Note:</b> If the language is changed, the system restarts. This takes a few seconds. The basic settings menu is also closed.
	Factory settings	Reset the appliance to the factory settings	Confirm the question "Delete all individual settings made and reset to factory settings?" by pressing ✓ or cancel by pressing X. <b>Note:</b> Individual drinks will also be deleted if the appliance is reset to factory settings. After resetting the factory settings, the "Initial settings" menu is displayed.
	Demo mode	On / Off*	Only for demonstration purposes. The "Off" setting must be activated for normal operation. The setting is only possible in the first 3 minutes after switching on the appliance.
	Milk container reminder	30* minutes - 6 hours	Setting for the time after which the reminder appears.
	Child lock	Not available*/Available	Available: The child lock can be activated. → "Child lock" on page 19

\* Factory setting

## Setting the milk container weight

Using the weight, the appliance detects the quantity of milk in the milk container to ensure that there is always sufficient milk to dispense e.g. Latte Macchiato. If there is too little milk in the container, a corresponding message will be displayed.

The weight of the supplied empty milk container and that of an empty Tetra Pak carton (approx. 30 g) are already saved under "Standard". The appliance automatically detects whether the milk container or a Tetra Pak carton is being used. However, you can also save the weight of your own milk container or a Tetra Pak carton (if its weight deviates from the standard value) under the "Individual" setting.

**Note:** The container filled with milk must not exceed the maximum weight of 2 kg.

- 1 Rotate the function selector to **S**.
- 2 Select "Basic settings" using the rotary selector.
- 3 Touch the ✓ symbol.
- 4 Select "Milk container weight" with the rotary selector.
- 5 Touch the ↵ symbol.
- 6 Select "Standard" (preset milk container weight) or "Individual" (own weight input for the milk container) using the rotary selector.
- 7 Press ✓ to confirm.
- 8 With the "Standard" setting the appliance automatically reverts to the "Basic settings" selection level  
or  
With the "Individual" setting, your own milk container can now be weighed and the weight saved.
- 9 Check whether the area for the milk container behind the door is free. Confirm with ✓.
- 10 Place an empty container, e.g. a milk jug, in the area and confirm with ✓.
- 11 Close the door.  
The weight of the container is determined and then displayed.
- 12 Press ✓ to confirm.  
The changes are saved.
- 13 Touch the ✕ symbol to leave the "Basic settings" menu.

## Messages

Depending on the setting in "Basic settings" or when dispensing a beverage with milk, various reminders or messages may be shown on the display:

"Reminder: Is the milk still fresh?"	Appears after a set time. → "Basic settings" on page 20  Please check whether the milk in the milk container is fresh.
"Reminder: Place milk in the refrigerator"	Appears when the appliance is switched off.
"Milk container connected?"	Message appears after selection of a beverage with milk. Please check and confirm.
"Not enough milk for the selected beverage"	Message appears when there is not enough milk in the milk container.

## Daily care and cleaning

### Daily maintenance

Every time the appliance is switched on or switched to **0**, it rinses automatically. Exception: the appliance was only switched off a few minutes beforehand or no coffee was dispensed before it was switched to **0**.

#### **Warning – Danger of electric shock!**

Before cleaning the appliance, switch it off using the main switch. Never immerse the appliance in water. Do not use a steam cleaner.

#### **Caution!**

Surface damage!

- Do not use any cleaning agents containing alcohol or spirits.
- Do not use abrasive cloths or cleaning agents.
- Always remove any residue of lime, coffee, milk and descaling solution immediately. This residue may cause corrosion to form.
- New sponge cloths may contain salts. Salts can cause rust film on stainless steel and must therefore be washed out thoroughly before use.

#### **Notes**

- The drip tray and coffee residue container should be emptied and cleaned every day to prevent deposits.
- Immediately remove residues from the shelf to avoid stains.
- If the appliance has not been used for a long time (e.g. while you are on holiday), clean the entire appliance thoroughly, including the milk system, ground coffee drawer and brewing unit before using.

- 1 Wipe the housing with a soft, damp cloth.
- 2 Remove the shelf, open the door and pull out the drip tray to the front.
- 3 Remove drip tray, cover and coffee residue container.
- 4 Empty, clean and dry the individual parts.
- 5 Rinse out the water tank with clear, fresh water.
- 6 Remove the ground coffee drawer, clean under running water and dry it thoroughly.
- 7 Wipe out the inside of the appliance (drip tray holder and ground coffee drawer) and the collecting tray and dry them.
- 8 Insert the dry parts, such as the ground coffee drawer.

#### **Caution!**

Not all of the appliance components can be cleaned in the dishwasher.

#### **Not dishwasher-safe:**



Shelf
Accessory drawer
Water tank with cover
Beverage dispenser cover
Metal connecting element
Bean container with lid
Ground coffee drawer
Protective cover for brewing unit
Brewing unit
Milk container

#### **Dishwasher-safe:**



max. 60°C

Collecting tray
Drip tray
Drip tray cover
Coffee residue container
Milk hoses
Milk tube
Individual parts of the beverage dispenser
Measuring spoon
Individual parts of the milk container lid
Shelf for the milk container

## Cleaning the milk system

The milk system is automatically cleaned with a short jet of steam directly after preparing a milk drink.

**Important:** Clean the milk system manually on a weekly basis, or more frequently if required.

### **⚠ Warning – Risk of burns!**

The beverage dispenser gets very hot. After use, let it cool down first before touching it.

### Cleaning the milk system automatically

- 1 Turn the function selector to **S**.
- 2 Use the rotary selector to select "Clean milk system".
- 3 Touch the ✓ symbol.  
The cleaning programme starts. The information in the display guides you through the programme.
- 4 Open the door.
- 5 Remove the milk tube from the milk container and wipe it down. Insert the end of the milk tube into the hole in the coffee residue container.

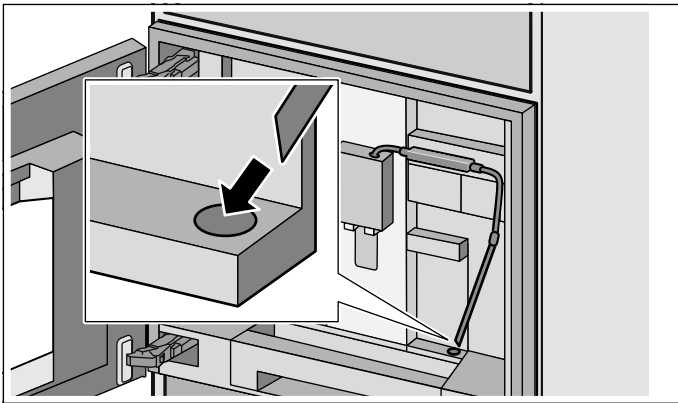

- 6 Close the door.
- 7 Place a container with a capacity of 0.5 l under the beverage dispenser.
- 8 Touch the ▶ symbol.  
The programme runs for approx. 1 minute. Then empty the container.
- 9 Touch the ✓ symbol.  
The programme has finished.

### Cleaning the milk system manually

Take the milk system apart to clean it:

- 1 Push the beverage dispenser down completely and pull the cover forwards to remove.

- 2 Press the snap lever to the left of the beverage dispenser downwards and pull the beverage dispenser straight forwards.

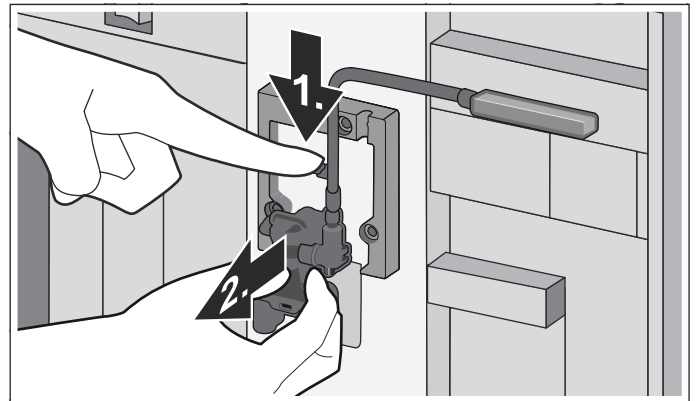

- 3 Detach the milk hose and dismantle the top and bottom sections of the beverage dispenser.

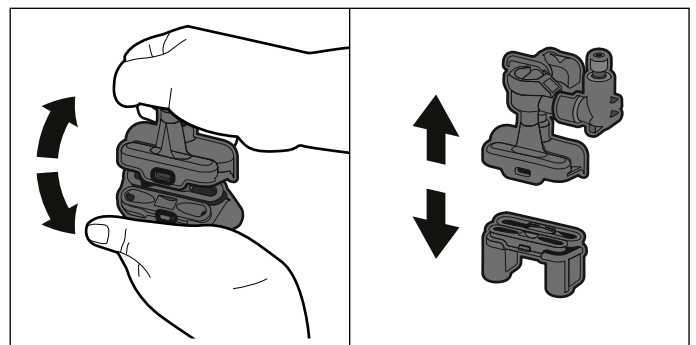

- 4 Separate the milk hoses, connecting element and milk tube.

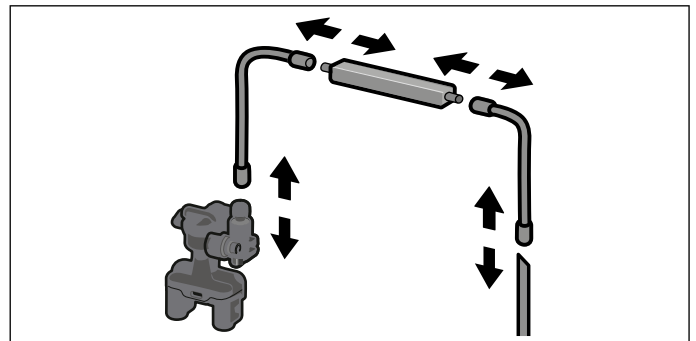

- 5 Clean the individual parts with a detergent solution and a soft cloth.
- 6 Rinse all parts with clean water and dry.
- 7 Put the individual parts back together again (also see quick reference guide).

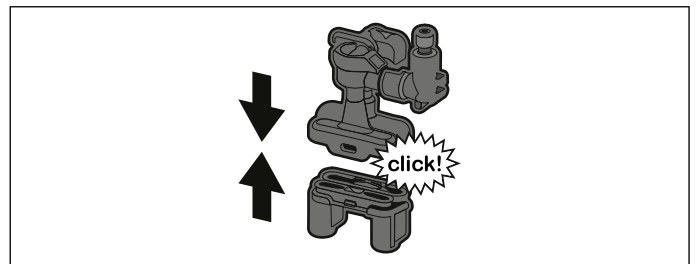

- 8 Firmly attach the beverage dispenser straight from the front onto the three connections.
- 9 Replace the cover.



## Cleaning the milk container

For reasons of hygiene the milk container must be cleaned regularly. Only the individual parts of the lid are dishwasher-safe. Clean the stainless steel milk container by hand using a mild cleaning agent.

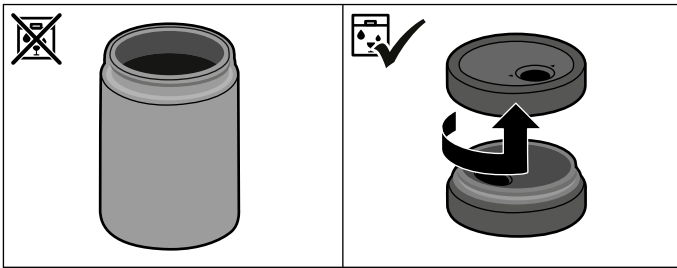

## Cleaning the brewing unit

(Also see the quick reference guide)

### Notes

- Regularly clean the brewing unit by hand in addition to the automatic cleaning programme.
- Do not use washing-up liquid or other cleaning agents to clean the brewing unit and do not put the brewing unit in the dishwasher.

- 1 Turn the function selector to **0**.
- 2 Open the door.
- 3 Switch off the appliance using the main switch.
- 4 Remove the protective cover of the brewing unit.
- 5 Remove the coffee residue container.
- 6 Slide the red latch on the brewing unit all the way to the left to .
- 7 Press the eject lever right down. The brewing unit will be released.
- 8 Take hold of the brewing unit by the recessed grips and carefully remove it.
- 9 Clean the brewing unit thoroughly under running water.

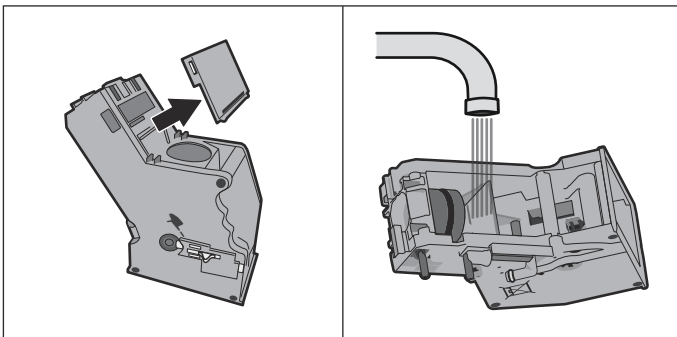

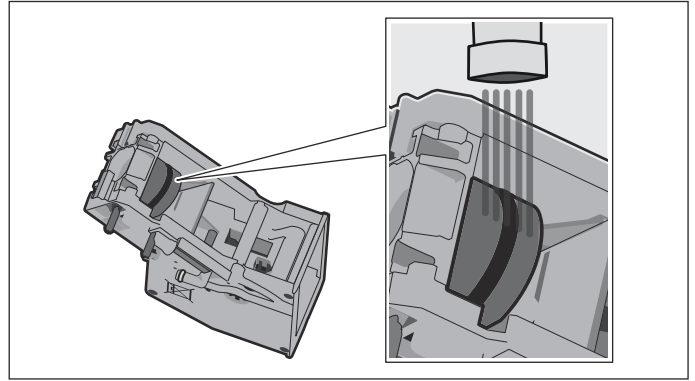

- 10 Remove the cover and clean the filter under running water.

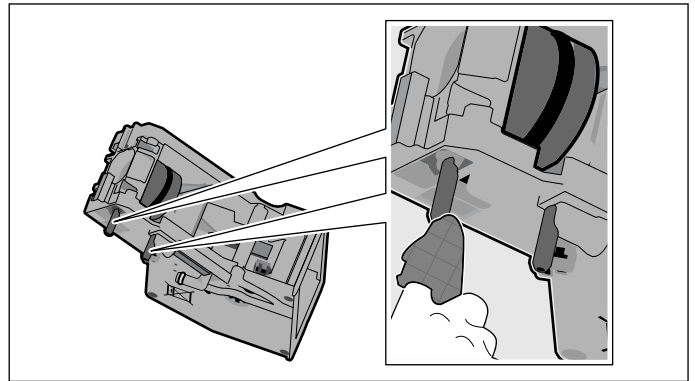

- 11 Thoroughly clean the connecting taps on the brewing unit.



- 12 Clean the interior of the appliance thoroughly, taking care to remove any coffee residues.
- 13 Allow the brewing unit and the interior of the appliance to dry.
- 14 Refit the cover.
- 15 Push the brewing unit all the way into the appliance, pressing on the middle until it audibly clicks into place.  
**Important:** The red latch must be right over to the left to  before inserting.
- 16 Press the eject lever all the way up and push the red latch right over to the right to .
- 17 Insert the coffee residue container.
- 18 Replace the protective cover.
- 19 Close the door.

---

## Service programmes

---

(Also see the quick reference guide)

Every so often – the exact frequency depends on usage and water hardness – one of the following messages will appear in the display in place of the coffee selection:

- Please change water filter
- Please clean
- Please descale
- Please descale and clean

The **i**<sup>®</sup> warning symbol then lights up.

The water filter should be changed immediately at this point and the appliance cleaned or descaled using the appropriate programme. Otherwise the appliance may be damaged.

The service programmes can also be started at any time without any prompt from the display. Set the function selector to **S** and select and run the desired programme.

### Notes

- **Caution!** Do not drink or come into contact with cleaning or descaling materials. Keep cleaning materials and descaling tablets out of the reach of children. They may be toxic.
- **Important:** If the appliance is not descaled in good time, the message "Appliance locked Descaling required urgently" will appear. Immediately perform the descaling process in accordance with the instructions. If the appliance is locked, it can only be operated again once descaling has been carried out.
- **Caution!** With each of the service programmes, use descaling and cleaning agents as described in the instructions and observe the (relevant) safety information.
- Do not drink the liquids.
- Never use vinegar, vinegar-based products, citric acid or citric acid-based products for descaling.
- When cleaning and descaling, only use the tablets intended for such purpose. They have been specially developed for this appliance, and new stocks can be ordered through the after-sales service. → "Accessories" on page 9
- Never insert descaling tablets or other products into the grounds compartment.
- Never interrupt the service programme.
- Prior to starting a service programme, remove, clean and reinsert the brewing unit. Rinse the milk system.

- At the end of a service programme, wipe down the appliance using a soft, damp cloth to immediately remove any descaler residue. This residue may cause corrosion.
- New sponge cloths may contain salts. Salts can cause rust film on stainless steel, so cloths must always be washed out thoroughly before use.
- If a service programme is interrupted, e.g. by a power failure, proceed as follows:
  - 1 Rinse out the water tank.
  - 2 Pour in fresh, still water up to the "max" mark and confirm. The programme starts and rinses the appliance. Duration approx. 2 minutes.
  - 3 Empty, clean and reinsert the drip tray.
- **Caution!** Do not drink the descale solution.

## Cleaning

**Duration: approx. 5 minutes**

Prior to starting the service programme, clean the brewing unit. → "Cleaning the brewing unit" on page 25

- 1 Rotate the function selector to **S**.
- 2 Select "Cleaning programme" using the rotary selector.
- 3 Touch the ✓ symbol. The cleaning programme starts. The information in the display guides you through the programme.
- 4 Empty and reinsert the drip tray and the coffee residue container.
- 5 Place a cleaning tablet in the ground coffee drawer and close the drawer again.
- 6 Close the door.
- 7 Place a container with a capacity of 0.5 l under the beverage dispenser.
- 8 Touch the ► symbol. The programme will run for approx. 5 minutes.
- 9 Empty and reinsert the drip tray.
- 10 Touch the ✓ symbol.

The cleaning programme has now ended.

## Descaling

Duration: approx. 21 minutes

- 1 Turn the function selector to **S**.
- 2 Select "Descaling programme" using the rotary selector.
- 3 Touch the ✓ symbol.  
The descaling programme starts. The notes in the display guide you through the programme.
- 4 Empty and replace the drip tray and the coffee dregs container.
- 5 Remove the water filter (if there is one) and touch the ✓ symbol.
- 6 Pour lukewarm water into the empty water tank up to the "calc" mark (0.5 l) and then dissolve a descaling tablet in it.
- 7 Remove the milk tube from the milk container and wipe it down. Insert the end of the milk tube into the hole in the coffee residue container.

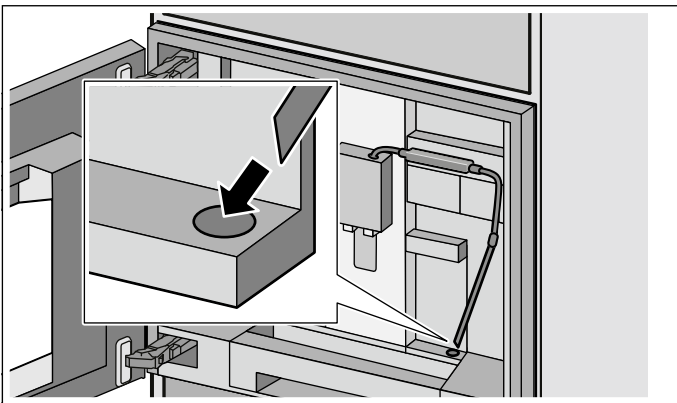

- 8 Close the door.
- 9 Place a container with a capacity of 0.5 l under the beverage dispenser.
- 10 Touch the ▶ symbol.  
The programme will run for approx. 19 minutes.  
**Note:** If there is too little descaling solution in the water tank, the message "Fill water tank with water and descaler" appears. Pour lukewarm water into the empty water tank up to the "calc" mark (0.5 l) and then dissolve a descaling tablet in it. Press ✓ to confirm. The programme will continue.
- 11 When prompted by the display, rinse the water tank and then fill it with fresh water up to the "max" mark. If a filter is used, reinsert it now.
- 12 Touch the ▶ symbol.  
The programme will run for approx. 2 minutes and rinse the appliance.
- 13 Empty and replace the drip tray.
- 14 Touch the ✓ symbol.  
The programme has finished.
- 15 Touch the ✓ symbol.  
The appliance is ready to use.

## Cleaning and descaling

Duration: approx. 26 minutes

The cleaning and descaling programme combines the individual cleaning and descaling functions. If the two programmes are both due at around the same time, the fully automatic espresso machine automatically suggests this service programme.

Prior to starting the service programme, clean the brewing unit. → "Cleaning the brewing unit" on page 25

- 1 Turn the function selector to **S**.
- 2 Select "Cleaning and descaling programme" using the rotary selector.
- 3 Touch the ✓ symbol.  
The cleaning and descaling programme starts. The notes on the display guide you through the programme.
- 4 Empty and replace the drip tray and the coffee dregs container.
- 5 Place a cleaning tablet in the ground coffee drawer and close the drawer again.
- 6 Remove the water filter (if there is one) and touch the ✓ symbol.
- 7 Pour lukewarm water into the empty water tank up to the "calc" mark (0.5 l) and then dissolve a descaling tablet in it.
- 8 Remove the milk tube from the milk container and wipe it down. Insert the end of the milk tube into the hole in the coffee residue container.

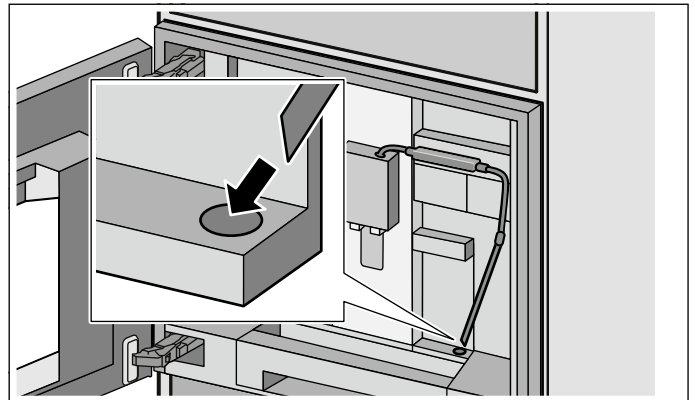

- 9 Close the door.
- 10 Place a container with a capacity of 0.5 l under the beverage dispenser.
- 11 Touch the ▶ symbol.  
The programme will run for approx. 19 minutes.  
**Note:** If there is too little descaling solution in the water tank, the message "Fill water tank with water and descaler" appears. Pour lukewarm water into the empty water tank up to the "calc" mark (0.5 l) and then dissolve a descaling tablet in it. Press ✓ to confirm. The programme will continue.

- 12 When prompted by the display, rinse the water tank and then fill it with fresh water up to the "max" mark. If a filter is used, reinsert it now.
  - 13 Touch the ► symbol.  
The programme will run for approx. 7 minutes and rinse the appliance.
  - 14 Empty and replace the drip tray.
  - 15 Touch the ✓ symbol.
- The programme has finished.
- 16 Touch the ✓ symbol.  
The appliance is ready to use.

---

## Emptying programme

---

The emptying programme is a service programme which is used to remove coffee bean residue and to prevent damage caused by frost during transportation and storage. The appliance must be ready for use.

- 1 Rotate the function selector to **S**.
- 2 Select "Emptying programme" with the rotary selector.
- 3 Touch the ✓ symbol.
- 4 Empty the bean container and reinsert it.
- 5 If present, remove the milk container and close the door.
- 6 Close the door.  
The emptying programme runs for approx. 2 minutes.
- 7 Empty and reinsert the water tank.
- 8 Close the door.  
The emptying programme runs for approx. 2 minutes.
- 9 Remove the brewing unit and clean it thoroughly.
- 10 Touch the ✓ symbol.
- 11 Clean the drip tray, coffee residue container, milk system and milk hose set thoroughly and then reinsert them.
- 12 Close the door.

The emptying programme has finished.

## Simple troubleshooting

Problem	Cause	Remedial action
The personally selected capacity is not reached. Coffee dispensing slows to a trickle or stops completely.	Grinding level is too fine. The ground coffee is too fine.	Adjust the grinding level to a coarser setting. Use coarser ground coffee.
	Heavy build-up of limescale in the appliance.	Descale the appliance as described in the instructions. → "Service programmes" on page 26
	The brewing unit is soiled.	Clean the brewing unit. → "Cleaning the brewing unit" on page 25
The hot water is milky or tastes of milk or coffee.	The milk hose has not been removed.	Remove the milk hose from the milk container.
	Milk or coffee residue in the beverage dispenser.	Clean the beverage dispenser.
The coffee has no crema.	Unsuitable type of coffee.	Use a type of coffee with a higher proportion of robusta beans.
	The beans are no longer freshly roasted.	Use fresh beans.
	The grinding level was not suitable for the coffee beans.	Set a finer grinding level.
The coffee is too "acidic".	The grinding level is too coarse. The ground coffee is too coarse.	Adjust the grinding level to a finer setting. Use finer ground coffee.
	Unsuitable type of coffee.	Change the type of coffee.
The coffee is too bitter.	Grinding level is too fine. The ground coffee is too fine.	Adjust the grinding level to a coarser setting. Use coarser ground coffee.
	Unsuitable type of coffee.	Change the type of coffee.
The coffee tastes burnt.	The brewing temperature is too high.	Reduce the temperature. → "Preparing beverages" on page 13
	Grinding level is too fine. Ground coffee is too fine.	Adjust the grinding level to a coarser setting. Use coarser ground coffee.
	Unsuitable type of coffee.	Change the type of coffee.
The coffee is too weak.	Coffee strength selected is too weak.	Use stronger coffee. → "Preparing beverages" on page 13
	Ground coffee drawer blocked with ground coffee.	Remove the ground coffee drawer, clean and dry it thoroughly.
The ground coffee gets stuck in the ground coffee drawer.	The ground coffee sticks together.	Do not compact the ground coffee in the ground coffee drawer.
	The ground coffee drawer is damp.	Remove the ground coffee drawer, clean and dry it thoroughly.
The water filter does not stay in position in the water tank.	The water filter is not fitted correctly.	Firmly press the water filter straight down into the tank connection.
The bean container sticks when inserted.	There are beans in the housing.	Remove beans.
The coffee grounds are not compact and are too wet.	The grinding level is set too fine or coarse, or not enough ground coffee has been used.	Set a coarser or finer grinding level or use 2 level measuring spoons of ground coffee.
The grinding level adjustment is stiff.	Too many beans in the grinding unit.	Dispense a beverage made from coffee beans. Only make any subsequent changes to the grinding level in small steps.
The brewing unit cannot be inserted.	Brewing unit in the wrong position.	Insert the brewing unit as described in the instructions. → "Cleaning the brewing unit" on page 25
	Brewing unit is locked.	Unlock brewing unit. → "Cleaning the brewing unit" on page 25
The protective cover of the brewing unit cannot be properly attached.	Brewing unit is not locked.	Lock the brewing unit. → "Cleaning the brewing unit" on page 25

<b>Problem</b>	<b>Cause</b>	<b>Remedial action</b>
There is water under the drip tray.	This is condensation.	Do not insert the drip tray without the cover.
Display screen "Milk container connected?" despite connected milk container.	Container is outside the range of the sensor.	Position the container at the right-hand edge.
	Material, e.g. milk carton, is not recognised.	Confirm the display query with "Yes" or use the supplied milk container.
No milk dispensed despite filled milk container.	The milk tube is not inserted deep enough in the milk container.	Insert the milk tube down to the bottom of the milk container.
The milk container is empty, but no message is displayed.	The shelf (scales) for the milk container is soiled.	Remove shelf. Clean the shelf and the area underneath thoroughly.
Display screen "High or low voltage".	Voltage is too high or too low.	Contact electricity or grid provider. Have the power supply checked by an expert.
Display screen "Let appliance cool down".	Appliance is too hot.	Switch off appliance for 30 minutes.
Display screen "Error: E0510".	The appliance has encountered an error.	Proceed according to the display screen.
Display screen shows "Fill bean container". The appliance does not grind the beans despite filled bean container.	Beans do not drop into the grinding unit (beans that are too oily may stick to the bean container).	Gently tap the bean container. Possibly change the type of coffee. When the bean container is empty, wipe it with a dry cloth.
Display screen shows "Remove brewing unit and clean by hand".	Brewing unit is soiled.	Clean the brewing unit.
	Too much ground coffee in the brewing unit.	Clean the brewing unit. Add no more than two level measuring spoons of ground coffee.
	The brewing unit mechanism is stiff.	Clean the brewing unit. → <i>"Cleaning the brewing unit" on page 25</i>
Display screen "Refill with still water or remove filter".	Water tank wrongly inserted.	Insert water tank correctly.
	Carbonated water in the water tank.	Fill the water tank with fresh tap water.
	Float is stuck in the water tank.	Remove the tank and clean thoroughly.
	New water filter not rinsed according to instructions, or water filter spent or defective.	Rinse the water filter according to the instructions and then switch on, or use a new water filter.
	Air in the water filter.	Immerse the water filter in water until no more air bubbles escape. Then insert the filter again.
Display screen "Clean trays and replace" despite being empty.	Drip tray is soiled and wet.	Clean and dry the drip tray thoroughly.
	Emptying is not detected when the appliance is off.	When the appliance is switched on, remove and reinsert the drip tray.
Display screen "Insert trays" despite being inserted.	Inside of appliance (tray holder) soiled.	Clean the inside.
	The coffee residue container was not fully inserted.	Push the coffee residue container all the way in.
Water dripped onto the inner floor of the appliance when the drip tray was removed.	Drip tray was removed too soon.	Wait a few seconds after the last drink was dispensed before removing the drip tray.
Display screen "Switch off appliance"	Appliance is too warm.	Allow the appliance to cool down.
	Brewing unit is soiled.	Clean the brewing unit.
Display screen "Contact after-sales service".	The appliance has encountered an error.	Please contact the hotline.
If you are unable to solve the problem, always call the hotline.		

---

## Technical data

---

Electrical connection (voltage – frequency)	220–240 V ~, 50 / 60 Hz
Power rating	1600 W
Maximum static pump pressure	19 bar
Maximum capacity of the water tank (without filter)	2,4 l
Maximum capacity of the coffee bean container	500 g
Length of the power cable	1,7 m
Dimensions (H x W x D)	455 x 590 x 444 mm
Weight, empty	21–22 kg
Type of grinder	Ceramic

**Gaggenau Hausgeräte GmbH**  
Carl-Wery-Straße 34  
81739 München  
GERMANY  
[www.gaggenau.com](http://www.gaggenau.com)

8001051624 (970116)  
en

**GAGGENAU**

