

Island ventilation hood AI 480

Contents

Safety notes	4
Operating for the first time	5
About use	5
Features of your new appliance	6
Island ventilation hood AI 480	6
Control panel	6
Accessories	7
Special accessories	7
Accessories for installation	7
Operation	8
Light	8
Fan levels	8
Special functions	10
Intensive time	10
Delayed shut-off	10
Interval ventilation	10
Cleaning and care	11
Cleaning the grease filters	11
Circulating air mode	12
Replacing the activated carbon filter	12
Cleaning the extractor hood	12
Maintenance	13
Lamp replacement	14
Inserting the lamp	14



Safety notes

Damaged appliances must not be operated.

The appliance must only be connected by an **authorised specialist**, paying attention to the relevant regulations of the power supply companies and the regional construction regulations.

Also observe the assembly instructions!

Connecting cables must not come into contact with hot cooking surfaces.

Do not operate the extractor hood without inserted lamps.

Never operate the appliance without a grease filter.

Hazardous or explosive substances and vapours must not be extracted!

The user is responsible for expert use and the perfect condition of the appliance.

Only operate the appliance under supervision.

Caution! Over-greased filters are a fire risk! Only ever deep-fry under the extractor under constant supervision. Be sure to clean the grease filter on a regular basis and change the activated charcoal filter.

Fire risk! Do not flambé meals under the extractor hood!

Operation of the extractor hood above a hearth for solid fuels, which poses a fire risk (e.g. sparks) is only permitted, if the hearth possesses a **closed and fixed lid**. The current local regulations must be obeyed. This does not apply to gas hobs and gas cookers.

Hobs may only be used under the extractor hood when pots and pans are placed on them!

When using more than 3 gas-operated rings at the same time, please operate the extractor hood at level 2 or higher. This prevents a build-up of heat in the appliance.

Note that one large burner of more than 5 kW (Wok) is equivalent to the power of 2 gas burners.

Never operate a gas cooking area without a cooking utensil on it. Regulate the flame in such a way that it does not project over the cooking utensil.

For safety reasons, do not place any heavy objects on the top of the appliance.

Do not clean the appliance with a steam cleaning apparatus or with water pressure because this poses a **risk of short-circuits**.

Isolate the appliance from the mains during every maintenance operation. To do this, remove the mains plug or actuate the corresponding fuse. If the mains plug is not accessible, the appliance must be switched off at fuse point.

Repairs must be carried out by authorised specialists, thus ensuring electrical safety.

No warranty claims can be lodged in the event of damage caused by failure to observe these instructions.

Adequate incoming air must be ensured if a wood, coal, gas or oil heater or an open hearth is operated in the same room as the one in which the hood is installed.

Safe operation is possible whenever the partial vacuum in the place where the firing equipment is installed does not exceed 4 Pa (0.04 mbar). This can be achieved whenever the air needed for combustion is able to enter through openings that cannot be sealed, for example in doors, windows, incoming/exhaust air wall boxes or other technical means.

After a power failure, the extactor will not go on again automatically. You can recommence operation by turning a knob or by pressing any key.

Technical modifications reserved.

Never allow children to play with the appliance. Do not let adults or children operate the appliance unsupervised:

- if they are mentally or physically unable to use the appliance safely and correctly,
- if they don't have the knowledge and experience to use the appliance safely and correctly.

Operating for the first time

Before operating the appliance for the first time, please pay attention to the following notes:

The appliance must be installed and connected by a specialist before it is operated for the first time.

Conscientiously read through the operating and assembly instructions before operating the appliance for the first time.

Remove the packaging from the appliance and dispose of it properly! Pay attention to the fact that there are accessories in the packaging!
Keep packaging elements (e.g. plastic foil, styrofoam parts) out of the reach of children!

Thoroughly clean the appliance before using it for the first time (see chapter "Cleaning and care").

Before operating the appliance for the first time, check that the mains connection is in proper working order.



This appliance is labelled in accordance with the European Directive 2002/96/EG concerning used electrical and electronic appliances (waste electrical and electronic equipment – WEEE). The guideline determines the framework for the return and recycling of used appliances as applicable.

Check the appliance for transport damage before installing it.

About use

The appliance is intended solely for use in the household and must not be put to any other uses.

In the event of malfunctions, first of all check the household fuses. If the problem has nothing to do with the power supply, please contact your specialist dealer or your local Gaggenau after-sales service.

Features of your new appliance

Island ventilation hood AI 480

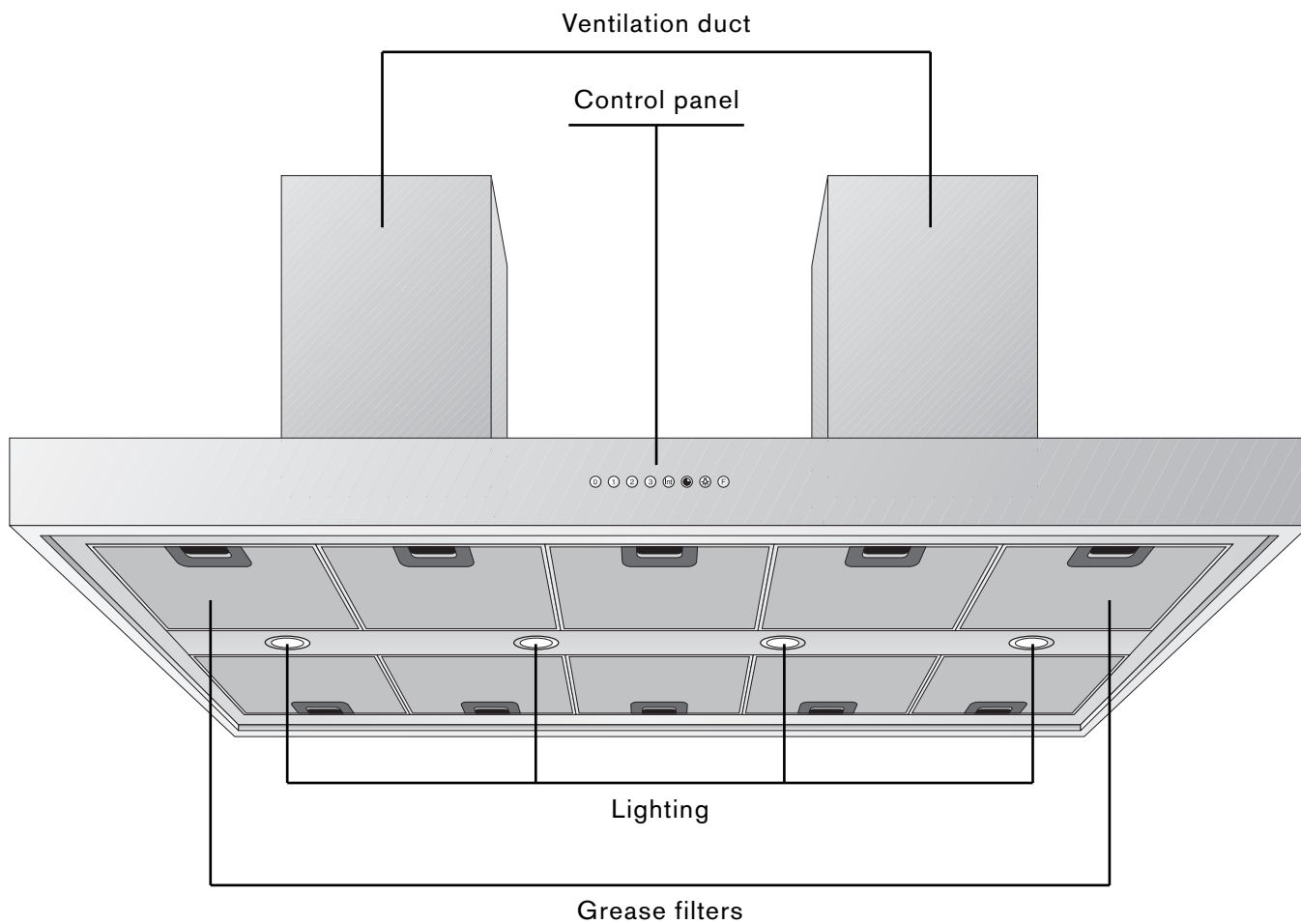

Control panel

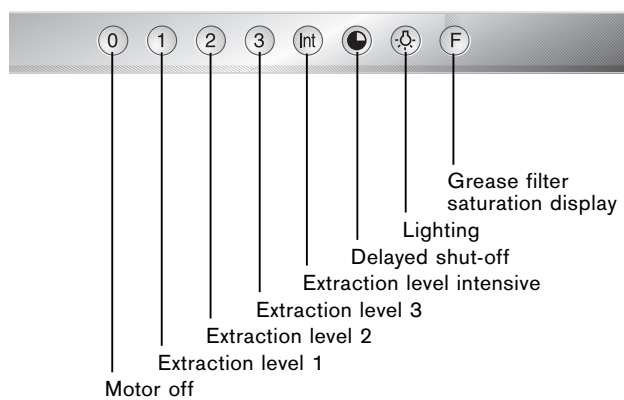

Accessories

Special accessories

You can order the following special accessories:

- **AA 480-180:** Activated carbon filter

Accessories for installation

You can order the following accessories for installation:

Installation accessories for exhaust air mode:

- **AD 480-016** for ceiling heights of 2.30 – 2.54 m
- **AD 480-026** for ceiling heights of 2.53 – 2.77 m
- **AD 480-036** for ceiling heights of 2.76 – 3.00 m

Installation accessories for circulating air mode:

- **AD 480-116** for ceiling heights of 2.30 – 2.54 m
- **AD 480-126** for ceiling heights of 2.53 – 2.77 m
- **AD 480-136** for ceiling heights of 2.76 – 3.00 m

Operation

After they have been pressed, all functions selection keys except 0 ("Motor off") are backlit in green.

Light

The lighting can be switched on or off, regardless of whether the extractor hood is in operation, by pressing the  key.

When you briefly press the  key, the lighting is increased up to the maximum level.

You can dim the lighting to the required level by keeping the  key pressed.

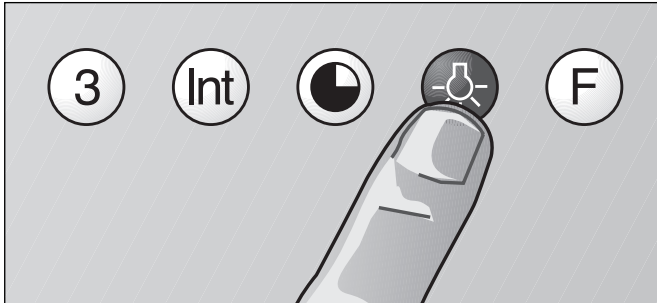

Fan levels

Three fan speeds and one intensive speed are available. You set the fan level required for each respective cooking situation by pressing the function selector keys 1, 2, 3 or Int.

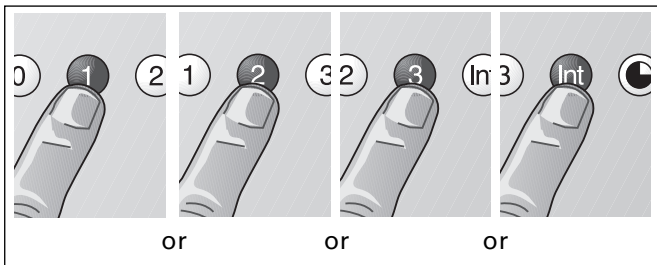

The **Int** key for the intensive level should be pressed when browning and frying in an open pan.

If you have switched on the hood by selecting the intensive level, it will be switched off again automatically after 5 minutes.

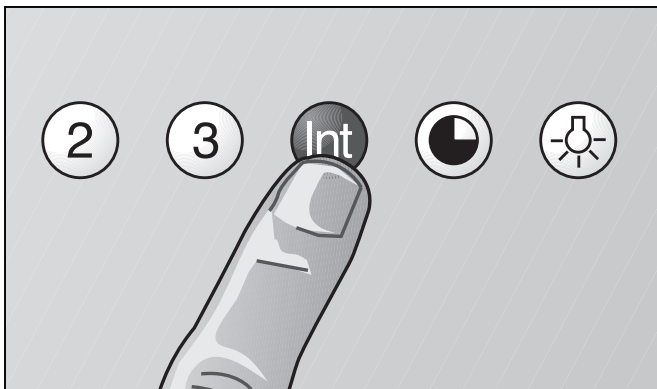

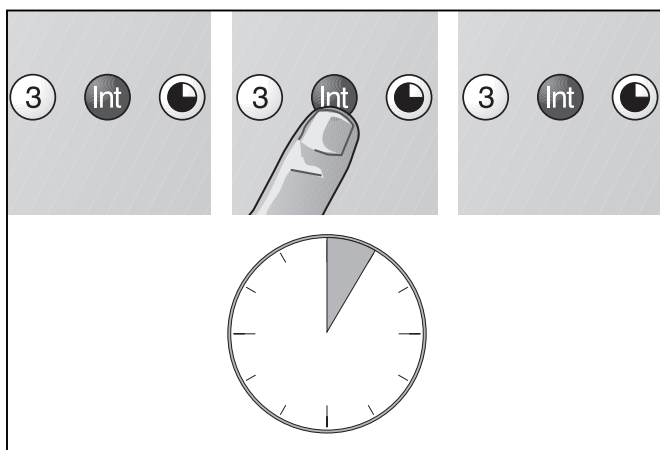

If you press the **Int** key while the hood is running at fan level **1**, **2** or **3**, the electronic control will switch back automatically to the previously selected fan level after 5 minutes.

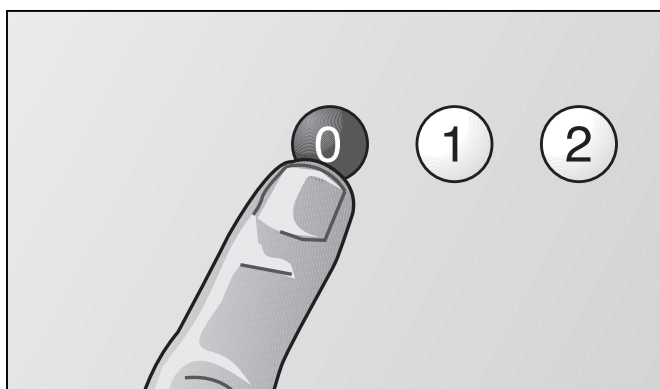

If you would like to end the intensive level before the five minutes have elapsed, press the **0** key ("Motor off") or select a different level. It is possible to switch off the extraction function at any time by pressing the **0** key (motor "off").

Special functions

Intensive time

You can set the intensive level running time to 3, 5 or 10 minutes by simultaneously pressing the **Int** key and the **1**, **2** or **3** key and you can store this setting. When delivered, the appliance is set to five minutes, i.e. the combination of the **Int** key and the key **2**.

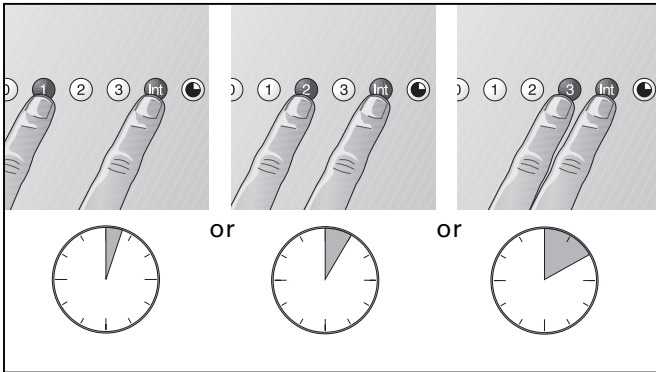

Delayed shut-off

Delayed shut-off is possible at any level. First press the required key **1**, **2**, **3** or **Int** and then press the  key.

The delayed shut-off time for all levels is ten minutes. After these ten minutes, the ventilation switches off, but the lighting stays on.

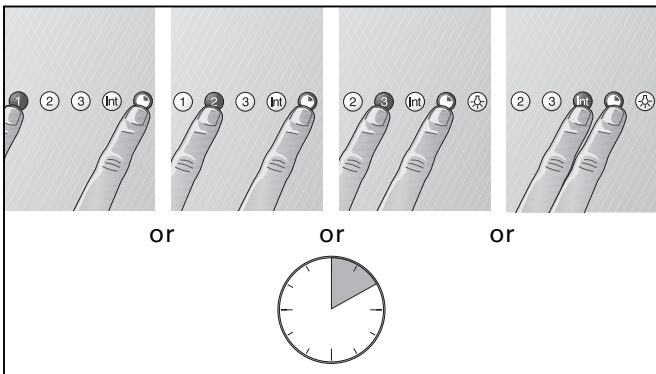

Interval ventilation

Interval ventilation is a special feature of this appliance which periodically activates the fan for five minutes every hour. You can activate this function by simultaneously pressing the **0** key and, depending on the required extraction capacity, the **1**, **2** or **3** key.

This mode of operation is indicated by alternating illumination of the  key together with the corresponding fan level indicator.

You can switch off interval ventilation by pressing the **0** key.

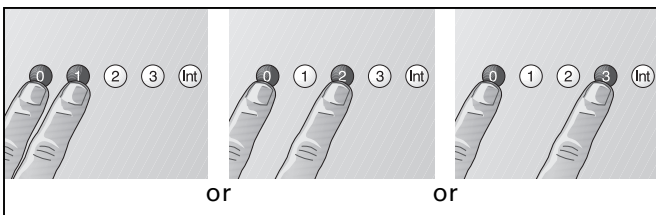

Cleaning the grease filters

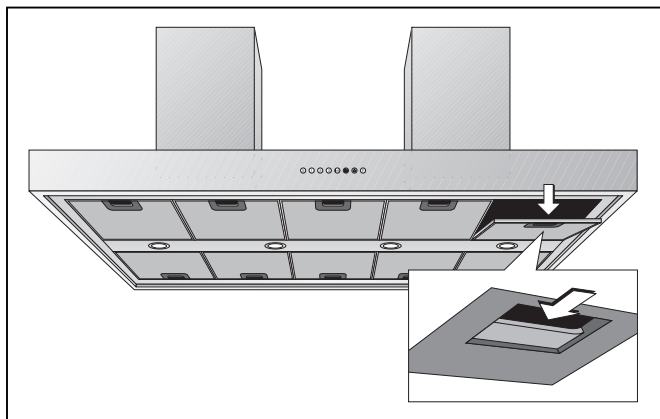

The grease filter saturation display **F** flashes after an operating time of 30 hours to indicate to you that you should clean the grease filter. The grease filters can of course be cleaned at any time, even if the grease filter saturation display has not started to flash.

- 1 The stainless steel grease filters can be removed easily for cleaning:
- 2 Disconnect the power supply (switch off the fuse).
Grip the grease filter handle and push the slide towards the rear. Then pull the grease filter downwards out of the holder; repeat the operation for the other grease filters.
- 3 You can clean the stainless steel grease filters in a dishwasher at a maximum temperature of 65°C, where it should be supported vertically to allow food or rinsing residues to drain off.

If possible, the inner parts of the housing should be wiped out in hot rinsing water when replacing the filters.

Caution:

when cleaning the inside of the housing, beware of protruding parts..

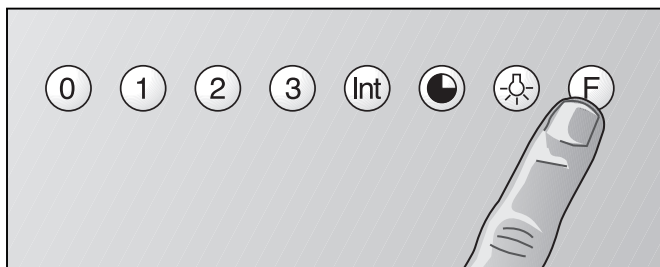

After having cleaned them, re-insert the grease filters in the extractor hood in reverse order.

Important:

the handles of both grease filters must be visible after assembly.

Press the **F** key to set the elapsed hours counter to zero. Flashing of the indicating lamp goes off.

Circulating air mode

The activated charcoal filter eliminates kitchen smells in the circulating air mode. In normal use (1 to 2 hours daily), the activated charcoal filter must be replaced approximately once a year.

If no activated charcoal filter is installed, kitchen smells will not be eliminated.

Replacing the activated charcoal filter

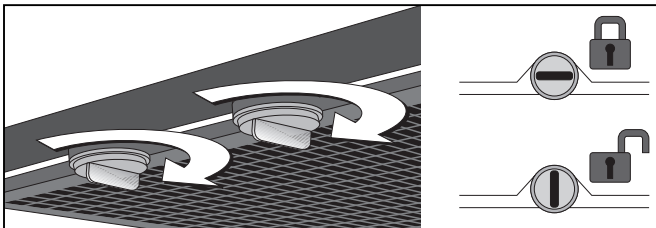

Remove the stainless steel grease filters.

Rotate the catches of the the activated carbon filter through 90°. Remove the activated carbon filter.

Insert the new activated carbon filter at an angle until the rear catch locks into place. Lift the activated carbon filter at the front and rotate the catches through 90°.

Re-insert the stainless steel grease filters.

Activated charcoal filters are available through your specialist dealer. Only use original filters.

Activated charcoal filters do not contain any dangerous substances. They can be disposed of through the household refuse collection. 1.

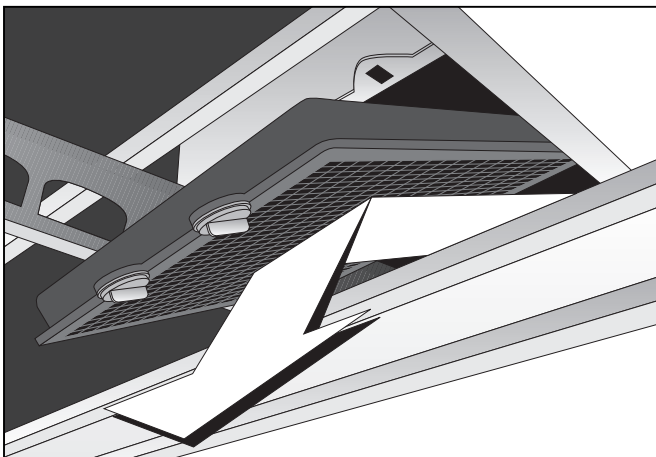

Cleaning the extractor hood

Clean the exterior of your extractor hood with a soft cloth and mild detergent solution. Do not use any strong, caustic or abrasive cleaning agents. Do not use any abrasive sponges or brushes either.

Maintenance

Disconnect the appliance from the mains before carrying out any repairs.

In the event of malfunctions, first of all check the household fuses.

If the power supply is in proper working order, but the appliance is nevertheless not functioning, then please contact your specialist dealer or Gaggenau after-sales service. Specify the appliance type (see rating plate).

Repairs must only be carried out by authorised specialists, thus ensuring the safety of the appliance. Improper tampering will render all warranty claims null and void.

Lamp replacement

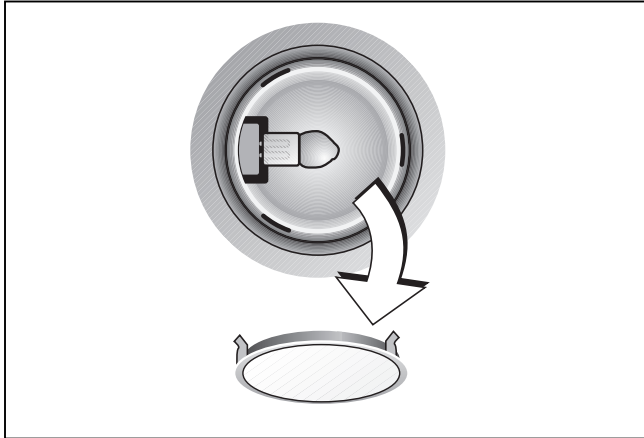

Caution: disconnect the power supply before replacing lamps (switch off the fuse)!

Caution: lamps may still be hot shortly after use!
Risk of burns.

- 1 Detach the ring from the lamp cover. Note: make sure that the glass will not fall out.
- 2 Pull out the lamp.

Defective lamps must only be replaced by lamps of the same type! (12 V/20 W/G4 lampholder)

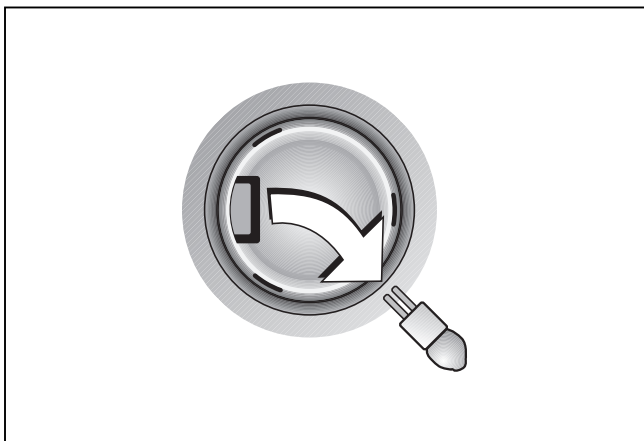

Inserting the lamp

- 1 Insert the lamp in the lampholder.
Note: do not touch the halogen lamps with your hands. Use a cloth and touch the lamp only on its edges.
- 2 Engage the lamp cover.
- 3 Connect the appliance to the mains again.

Gaggenau Hausgeräte GmbH
Carl-Wery-Straße 34
D-81739 München
www.gaggenau.com

06067815_en 0209
9000191476 EB 8607 en

GAGGENAU