

Gaggenau Use and care manual

BO 480/481 611

Built-in oven

Table of Contents

Safety Definitions	3
IMPORTANT SAFETY INSTRUCTIONS	4
Proper Installation and Maintenance	4
Fire Safety	4
Burn Prevention	5
Child Safety	5
Cleaning Safety	6
Cookware Safety	6
State of California Proposition 65 Warnings	6
Causes of damage	7
Protecting the environment	7
Tips for saving energy	7
Getting to know the appliance	8
Oven	8
Displays and controls	9
Symbols	9
Colors and display	10
Automatic door opening	10
Additional information i and i [®]	10
Cooling fan	10
Program selection positions	11
Accessories	13
Special accessories	13
Before first use	14
Setting the language	14
Setting the time format	14
Setting the time	14
Setting the date format	14
Setting the date	15
Setting the temperature format	15
Completing initial set-up	15
Heating up the oven	15
Cleaning accessories	15
Activating the appliance	16
Standby	16
Activate appliance	16
Operating the appliance	16
Oven interior	16
Inserting the rack	17
Turning on	17
Quick heat	17
Safety shut-off	17

Timer functions	18
Launching the timer menu	18
Timer	18
Stopwatch	18
Cooking time	19
End of cooking time	20
Sabbath mode and Yom Tov mode	21
Sabbath mode	21
Yom Tov mode	22
Personal recipes	23
Recording a recipe	23
Programming a recipe	23
Entering a name	24
Starting a recipe	24
Deleting a recipe	24
Core temperature probe	25
Insert the core temperature probe in the food to be cooked	25
Setting the core temperature	26
Core temperature guidelines	26
Rotisserie spit	28
Preparation	28
Switching on the rotisserie spit	29
Switching off the rotisserie spit	29
Roasting function	30
Child lock	30
Activating the child lock	30
Deactivating the child lock	30
Factory setting	31
Cleaning and maintenance	33
Cleaning agents	33
Removing slide-in racks	34
Self-clean (pyrolysis)	34
Preparing the pyrolytic self-cleaning feature	35
Starting self-clean (pyrolysis)	35
Cleaning the Accessories with the Pyrolytic Self-cleaning Feature	35
Troubleshooting	36
Power cut	36
Demo mode	36
Replacing the oven lamp	37

Customer service	38
Tables and tips	39
Vegetables	40
Side dishes and dishes	41
Fish	44
Meat	45
Poultry	48
Grilling and roasting	49
Baked goods	50
Dough proving (leaving to rise)	54
Desserts	54
Defrosting	55
Preserving	56
Disinfecting	56
Drying	56
Baking stone	57
Roasting dish	58
Acrylamide in foodstuffs	59

Additional information on products, accessories, replacement parts and services can be found at www.gaggenau.com and in the online shop www.gaggenau.com/zz/store

Safety Definitions

WARNING

This indicates that death or serious injuries may occur as a result of non-observance of this warning.

CAUTION

This indicates that minor or moderate injuries may occur as a result of non-observance of this warning.

NOTICE: This indicates that damage to the appliance or property may occur as a result of non-compliance with this advisory.

Note: This alerts you to important information and/or tips.



IMPORTANT SAFETY INSTRUCTIONS

READ AND SAVE THESE INSTRUCTIONS

WARNING

When properly cared for, your new appliance has been designed to be safe and reliable. Read all instructions carefully before use. These precautions will reduce the risk of burns, electric shock, fire, and injury to persons. When using kitchen appliances, basic safety precautions must be followed, including those in the following pages.

Proper Installation and Maintenance

Have the installer show you the location of the circuit breaker or fuse. Mark it for easy reference.

This appliance must be properly installed and grounded by a qualified technician. Connect only to properly grounded outlet. Refer to Installation Instructions for details.

This appliance is intended for normal family household use only. It is not approved for outdoor use. See the Statement of Limited Product Warranty. If you have any questions, contact the manufacturer.

Do not store or use corrosive chemicals, vapors, flammables or nonfood products in or near this appliance. It is specifically designed for use when heating or cooking food. The use of corrosive chemicals in heating or cleaning will damage the appliance and could result in injury.

Do not operate this appliance if it is not working properly, or if it has been damaged. Contact an authorized servicer.

Do not obstruct oven vents.

Do not repair or replace any part of the appliance unless specifically recommended in this manual. Refer all servicing to an authorized servicer.

WARNING

Risk of burns

To avoid risk of injury, turn off the interior light before cleaning the oven to allow the bulbs to cool down. The bulbs can become very hot when switched on. Keep the light off while cleaning the oven.

WARNING

Make sure the appliance and lights are cool and power to the appliance has been turned off before replacing the light bulb(s). Failure to do so could result in electrical shock or burns. The lenses (if equipped) must be in place when using the appliance. The lenses (if equipped) serve to protect the light bulb from breaking. The lenses (if equipped) are made of glass. Handle carefully to avoid breaking. Broken glass can cause an injury.

WARNING

Light socket is live when door is open if main power supply is not turned off.

Fire Safety

WARNING

NEVER cover any slots, holes or passages in the oven bottom or cover an entire rack with materials such as aluminum foil. Doing so blocks air flow through the oven. Aluminum foil linings may also trap heat, causing a fire hazard.

If materials inside an oven or warming drawer should ignite, keep door closed. Turn off the appliance and disconnect the circuit at the circuit breaker box.

WARNING

Use this appliance only for its intended use as described in this manual. NEVER use this appliance as a space heater to heat or warm the room. Doing so may result in overheating the appliance. Never use the appliance for storage.

Always have a working smoke detector near the kitchen.

In the event that personal clothing or hair catches fire, drop and roll immediately to extinguish flames.

Have an appropriate fire extinguisher available, nearby, highly visible and easily accessible near the appliance.

Smother flames from food fires other than grease fires with baking soda. Never use water on cooking fires.

IMPORTANT SAFETY INSTRUCTIONS

READ AND SAVE THESE INSTRUCTIONS

WARNING

TO REDUCE THE RISK OF INJURY TO PERSONS IN THE EVENT OF A GREASE FIRE, OBSERVE THE FOLLOWING:

- a) SMOTHER FLAMES with a close-fitting lid, cookie sheet, or metal tray, then turn off the burner. BE CAREFUL TO PREVENT BURNS. If the flames do not go out immediately, EVACUATE AND CALL THE FIRE DEPARTMENT.
 - b) NEVER PICK UP A FLAMING PAN – You may be burned.
 - c) DO NOT USE WATER, including wet dishcloths or towels – a violent steam explosion will result.
 - d) Use an extinguisher ONLY if:
 - You know you have a Class ABC extinguisher, and you already know how to operate it.
 - The fire is small and contained in the area where it started.
 - The fire department is being called.
 - You can fight the fire with your back to an exit.
-

Burn Prevention

DO NOT TOUCH HEATING ELEMENTS OR INTERIOR SURFACES OF OVEN - Heating elements may be hot even though they are dark in color. Interior surfaces of an oven become hot enough to cause burns. During and after use, do not touch, or let clothing, potholders, or other flammable materials contact heating elements or interior surfaces of oven until they have had sufficient time to cool. Other surfaces of the appliance may become hot enough to cause burns. Among these surfaces are oven vent openings, surfaces near these openings and oven doors.

Exercise caution when opening the appliance. Standing to the side, open the door (or drawer) slowly and slightly to let hot air and/or steam escape. Keep your face clear of the opening and make sure there are no children or pets near the unit. After the release of hot air and/or steam, proceed with your cooking. Keep doors shut unless necessary for cooking or cleaning purposes. Do not leave open doors unattended.

Do not heat or warm unopened food containers. Build-up of pressure may cause the container to burst and cause injury.

Use caution when cooking foods with high alcohol content (e.g. rum, brandy, bourbon) in the oven. Alcohol evaporates at high temperatures. There is a risk of burning as the alcohol vapors may catch fire in the oven.

Use only small quantities of alcohol in foods, and open the oven door carefully.

Always place oven racks in desired location while oven is cool. Always use oven mitts, when the oven is warm. If a rack must be moved while oven is hot, do not let potholder contact the heating elements.

CAUTION

To avoid possible injury or damage to the appliance, ensure rack is installed exactly per installation instructions and not backwards or upside down.

Always use dry potholders. Moist or damp potholders on hot surfaces may result in burns from steam. Do not let potholder touch hot heating elements. Do not use a towel or other bulky cloth.

Secure all loose garments, etc. before beginning. Tie long hair so that it does not hang loose, and do not wear loose fitting clothing or hanging garments, such as ties, scarves, jewelry, or dangling sleeves.

Child Safety

When children become old enough to use the appliance, it is the responsibility of the parents or legal guardians to ensure that they are instructed in safe practices by qualified persons.

Do not allow anyone to climb, stand, lean, sit, or hang on any part of an appliance, especially a door, warming drawer, or storage drawer. This can damage the appliance, and the unit may tip over, potentially causing severe injury.

Do not allow children to use this appliance unless closely supervised by an adult. Children and pets should not be left alone or unattended in the area where the appliance is in use. They should never be allowed to play in its vicinity, whether or not the appliance is in use.

CAUTION

Items of interest to children should not be stored in an appliance, in cabinets above an appliance or on the backsplash. Children climbing on an appliance to reach items could be seriously injured.



IMPORTANT SAFETY INSTRUCTIONS

READ AND SAVE THESE INSTRUCTIONS

Cleaning Safety

IMPORTANT SAFETY NOTICE: The California Safe Drinking Water and Toxic Enforcement Act requires the Governor of California to publish a list of substances known to the state to cause cancer, birth defects or other reproductive harm, and requires businesses to warn customers of potential exposure to such substances. The burning of gas cooking fuel and the elimination of soil during self-cleaning can generate some by-products which are on the list. To minimize exposure to these substances, always operate this unit according to the instructions contained in this booklet and provide good ventilation.

When self-cleaning, confirm that the door locks and will not open. If the door does not lock, do not run Self-Clean. Contact service.

Wipe out excessive spillage before self-cleaning the oven.

Birds have very sensitive respiratory systems. Keep pet birds out of the kitchen or other rooms where kitchen fumes could reach them. During self-clean, fumes are released that may be harmful to birds. Other kitchen fumes such as overheating margarines and cooking oils may also be harmful.

Keep oven free from grease build up.

Cookware Safety

NOTICE: Do not place food directly on oven bottom.

Follow the manufacturer's directions when using cooking or roasting bags.

Do not clean parts or accessories in the self-clean oven.

WARNING

Risk of electric shock

Use of a wrong core temperature probe can damage the insulation. Use only the core temperature probe intended for this appliance.

State of California Proposition 65 Warnings

WARNING

This product can expose you to chemicals including vinyl chloride, which is known to the State of California to cause cancer and birth defects or other reproductive harm. For more information go to www.P65Warnings.ca.gov.

Causes of damage

NOTICE:

- Accessories, foil, baking paper or cookware on the bottom of the oven interior: do not place any accessories on the bottom of the oven interior. Do not line the bottom of the oven interior with any type of foil or baking paper. Do not place cookware on the bottom of the oven interior when a temperature above 122°F (50 °C) is set. This produces a build-up of heat. Baking and roasting times are no longer correct and the enamel is damaged.
- Water in the hot oven interior: Never pour water into the hot oven interior. Steam is produced. Damage to the enamel can arise due to the temperature change.
- Do not leave moist groceries in a closed oven for an extended period of time. It can lead to corrosion inside the oven.
- Fruit juice can leave stains in the oven. Always remove fruit juice immediately when safe to touch, and wipe up first with a damp and then a dry cloth.
- Cooling with the appliance door open: only allow the oven cavity to cool when it is closed. Even if the appliance door is only open a little, front panels of adjacent units could be damaged over time.
- Highly soiled door seal: the appliance door will no longer close properly during operation if the door seal is highly soiled. Adjoining furniture fronts may be damaged. Always keep the door seal clean.
- Appliance door as a seat or storage surface: do not stand, sit or hang on the appliance door. Do not place any cookware or accessories on the appliance door.
- Inserting accessories: depending on the appliance type, accessories can scratch the door pane when closing the appliance door. Always slide accessories fully into the oven interior.
- Do not hold or carry the appliance by the door handle. The door handle cannot carry the weight of the device and could break off.

Protecting the environment

Unpack the appliance and dispose of the packaging in an environmentally friendly manner.

Tips for saving energy

- Open the appliance door as little as possible while cooking, baking or roasting.
- Use dark, black-painted or enameled baking forms. These absorb the heat particularly well.
- It is best to bake several cakes in succession. The oven is still warm. This shortens the baking time for the second cake. You can also slide in two loaf tins next to each other.
- In the hot air mode, you can bake simultaneously on several levels.
- For longer cooking times, you can switch off the oven 10 minutes before the end of the cooking time and you can use the residual heat to finish cooking.

Getting to know the appliance

You will get to know your new appliance here. We explain the control panel and the individual controls to you. You are informed about the oven interior and accessories.

Oven

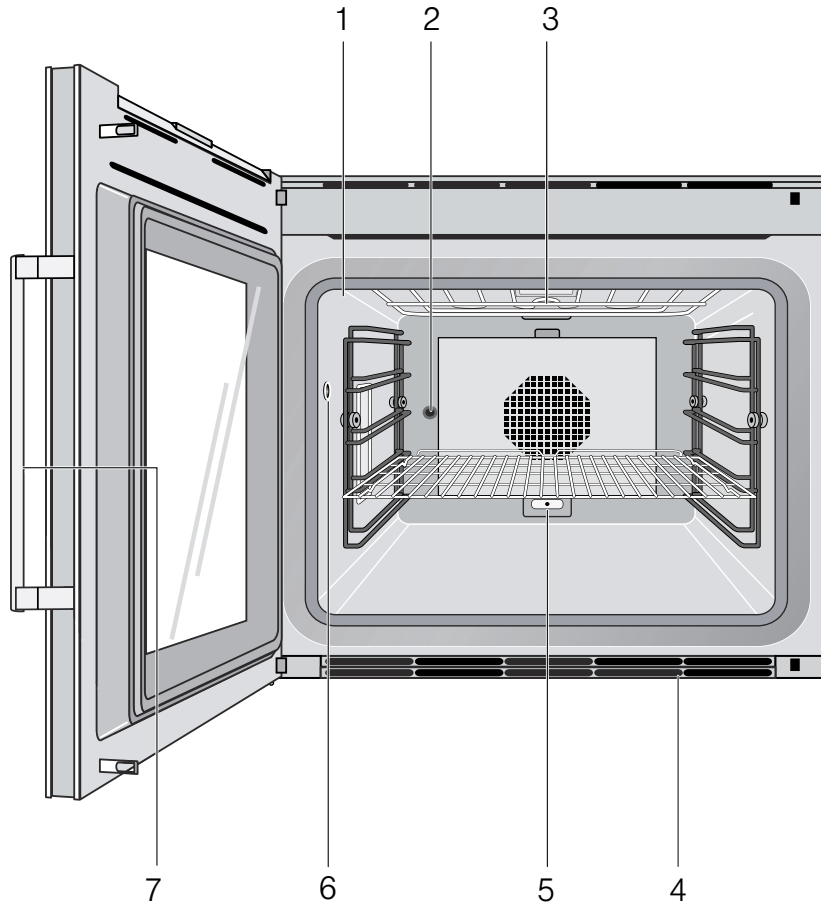

1	Door seal
2	Rotisserie spit drive
3	Grill heating element
4	Oven vents
5	Socket for additional heating element (special accessory for baking stone and roaster)
6	Socket for core temperature probe
7	Recessed handle

NOTICE: Do not place food directly on oven bottom.

Do not obstruct oven vents.

Displays and controls

These instructions apply to different versions of the appliance. Slight deviations are possible depending on the appliance type.

Operation is identical for all appliance versions.

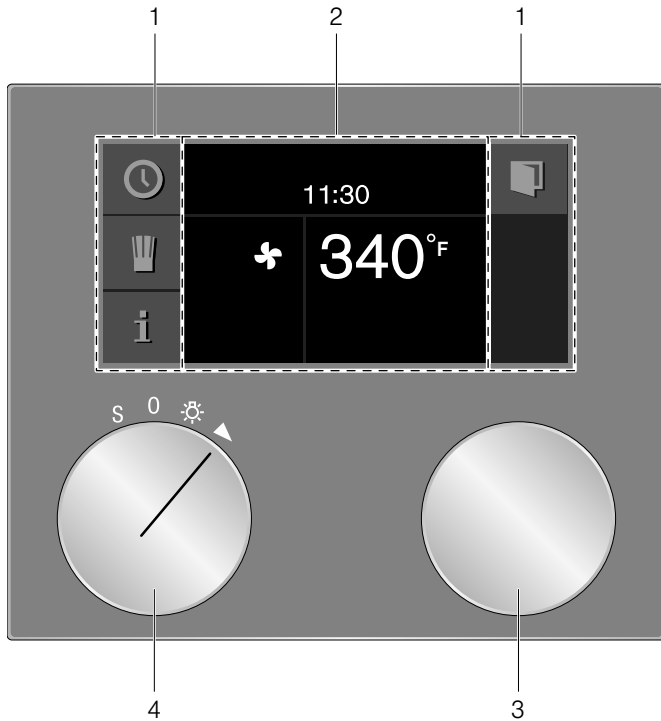

1	Control panel	These areas are touch-sensitive. Touch a symbol to select the applicable function.
2	Display	The display shows current settings and options, for example.
3	Rotary selector	With the rotary selector you can select the temperature and make other settings.
4	Program selector	With the program selector, you can select the heating function, the cleaning function or the basic settings.

Symbols

Symbol	Function
▶	Start
■	Stop
	Pause/end
X	Cancel
C	Delete
✓	Confirm/save settings
>	Selection arrow
🚪	Open appliance door
i	Launching additional information
⏩	Quick heating with status indicator
🍷	Launching personal recipes
rec ●	Recording a menu
↘	Edit settings
>A ^A	Enter a name
⏪	Delete letters
🔒	Child lock
🕒	Launching the timer menu
🕒	Launching the Sabbath mode
🔧	Demo mode
🍷	Core temperature probe
🍷	Start rotisserie spit
🍷	Stop rotisserie spit
⏩	Start pre-roast stage
⏩	End pre-roast stage

Colors and display

Colors

The various colors serve to guide you in the various adjustment situations.

Orange	First settings Main functions
Blue	Basic settings Cleaning
White	Adjustable values

Presentation

The presentation of symbols, values or the entire display changes depending on the situation.

Zoom	The display of the setting you are just changing is enlarged. Just before it elapses, a duration that is just elapsing is enlarged (e.g. the last 60 seconds in the case of timers).
Minimized display screen	After a short time, the display screen is minimized and only the most important things are displayed. This function is the default and can be modified in the basic settings.

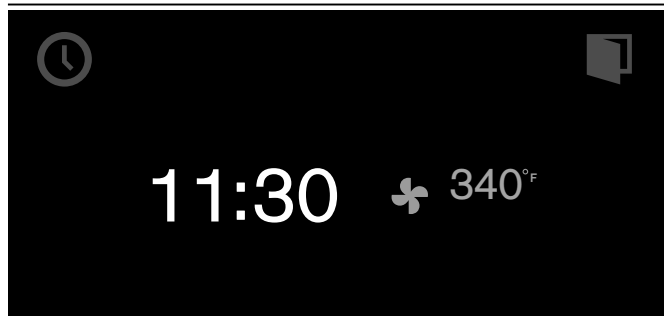

Automatic door opening

When you touch the  symbol, the appliance door springs open and you can open it fully with the handle recess at the side.

Automatic door opening does not work when the child lock is activated or in the event of a power failure. You can open the door manually with the handle recess at the side.

Additional information **i** and **i**[Ⓢ]

By touching the **i** symbol, you can call up additional information. For example, information on the heating function set or on the current temperature of the cooking compartment.

Note: During continuous operation, small fluctuations in temperature are normal after the oven has heated up.

The **i**[Ⓢ] symbol is displayed for important information and action prompts. Important information on safety and operation mode are occasionally shown automatically. These messages either disappear automatically after a few seconds or must be confirmed with .

Cooling fan

Your appliance has a cooling fan. The cooling fan switches on during operation. Depending on the appliance version, the warm air escapes above or under the door.

After removing cooked food, keep the door closed until the appliance cools down. The appliance door must not be left ajar, as adjoining kitchen furniture may be damaged. The cooling fan continues to run for a while and then switches off automatically.









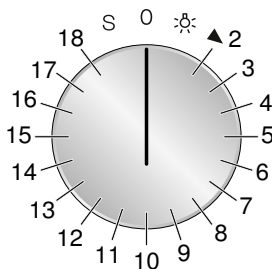

CAUTION

Do not cover up the ventilation slots. Otherwise, the appliance will become overheated.

Program selection positions



Position	Function/type of heating	Temperature	Application
0	Off position		
☀	Light		
2	Convection	120 - 550°F (50 - 300°C) Default temperature 340°F (170°C)	Convection: For cakes, cookies and baked casseroles on several levels. The fan in the rear wall of the oven distributes the heat evenly throughout the cooking compartment.
3	Economy	120 - 550°F (50 - 300°C) Default temperature 340°F (170°C)	Energy-saving convection mode for cakes, meat, baked casseroles, and gratins. The convenience features (e.g. the oven lighting) remain off. The oven temperature can only be displayed while the oven is heating up. Do not preheat the oven. Place the food into the cold, empty cooking compartment and start the stated cooking time. Keep the oven door closed during cooking to prevent heat escaping from the oven.
4	--- Top + bottom heat	120 - 550°F (50 - 300°C) Default temperature 340°F (170°C)	For cakes in pans or sheet cakes, baked casseroles, roasting.
5	--- Top + 1/3 bottom heat	120 - 550°F (50 - 300°C) Default temperature 340°F (170°C)	For sheet cakes, cookies, cakes with meringue, grilling, and baked casseroles with gratin. Very well-suited for a situation when the food should be heated from above toward the end of preparation.
6	--- Top heat	120 - 550°F (50 - 300°C) Default temperature 340°F (170°C)	Targeted heat from above, for example grilling cake topped with fruit and meringue.
7	--- 1/3 top + bottom heat	120 - 550°F (50 - 300°C) Default temperature 340°F (170°C)	For cheesecake, bread in loaf pans, dishes in a water bath (e.g. egg custard, crème brûlée). For roasting without a lid and warming up foods (foods dry out less). Very well-suited for a situation when the food should be heated from above toward the end of preparation.
8	--- Bottom heat	120 - 550°F (50 - 300°C) Default temperature 340°F (170°C)	For the final baking stage (such as for moist cakes topped with fruit), for preserving, for dishes in a water bath.
9	Convection + bottom heat	120 - 550°F (50 - 300°C) Default temperature 340°F (170°C)	Additional heat from below for moist cakes, such as cake topped with fruit.
10	Convection + 1/3 bottom heat	120 - 550°F (50 - 300°C) Default temperature 340°F (170°C)	For high baked casseroles, lasagne, onion tart, egg dishes (e.g. tortillas, farmers' omelettes).
11	Broil + circulated air	120 - 550°F (50 - 300°C) Default temperature 430°F (220°C)	Even, all-round heating for meat, poultry and whole fish.

Position	Function/type of heating	Temperature	Application
12	 Broil	120 - 550°F (50 - 300°C) Default temperature 430°F (220°C)	To grill flat pieces of meat, sausages or fillets of fish. Cooking "au gratin."
13	 Economy broil	120 - 550°F (50 - 300°C) Default temperature 430°F (220°C)	Only the center part of the grill heating element is heated. Energy-saving grilling for small amounts.
14	 Baking stone function	120 - 550°F (50 - 300°C) Default temperature 480°F (250°C)	Baking stone only available as a special accessory Baking stone heated from below for crisp stone-baked pizza, bread or rolls.
15	 Roaster function	120 - 430°F (50 - 220°C) Default temperature 360°F (180°C)	Roasting dish only available as a special accessory Heatable cast iron roasting pan for large quantities of meat, baked casseroles or holiday roasts.
16	 Dough proofing	85 - 120°F (30 - 50°C) Default temperature 100°F (38°C)	Proofing: For yeast dough and sourdough. Dough will proof considerably more quickly than at room temperature. The optimal temperature setting for yeast dough is 100°F (38 °C).
17	 Defrosting	100 - 140°F (40 - 60°C) Default temperature 115°F (45°C)	Even, gentle defrosting. For vegetables, meat, fish and fruit.
18	 Keeping warm	85 - 250°F (30 - 120°C) Default temperature 160°F (70°C)	Keeping food warm, pre-heating crockery.
S	 Basic settings		The basic settings of your appliance can be adjusted individually.
	 Pyrolytic cleaning	905°F (485°C)	Self-cleaning

Accessories

Use only the accessories included or obtainable from after-sales service. It has been specially adapted to your appliance. Make sure you always insert accessories into the interior the right way round.

Your appliance comes with the following accessories:

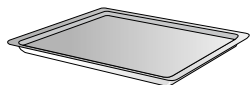

Baking tray, enameled



Wire grill tray



Grill tray with wire rack

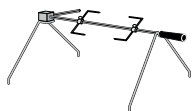

Rotisserie spit

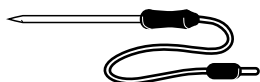

Plug-in core temperature probe

Special accessories

You can order the following accessories from your specialist dealer:

- BA 478 110 Handle, stainless steel
- BA 018 165 Pull-out system
Fully extendable telescopic pull-out rack and pyrolysis-proof cast frame
- BA 028 115 Baking tray, enameled, 30 mm deep
- BA 038 165 Wire rack, chrome-plated, with feet
- BA 058 115 Heating element for baking stone and roaster
- BA 058 133 Baking stone
Including heating element and pizza paddle (order heating element separately)
- BS 020 002 Pizza paddle, set of 2
- GN 340 230 Cast aluminum roaster GN 2/3, 6½" (165 mm) high, non-stick

Use the accessories only as indicated. The manufacturer assumes no liability for incorrect usage of the accessories.

Remove any accessories that are not required during operation from the cooking compartment. Bush for the additional heating element at the back of the cooking compartment: Always leave the cover in during normal operation without the additional heating element.

Before first use

In this chapter, you can find out what you must do before using your oven to prepare food for the first time. Read the "Safety information" chapter beforehand.

The appliance must be completely fitted and connected.

The "First settings" menu appears in the display after the mains has been connected. You can now set your new appliance:

- Language
- Time format
- Time
- Date format
- Date
- Temperature format

Notes

- The "Initial settings" menu only appears when you first connect the power or if the appliance has been without power for several days. After connecting the power, first the GAGGENAU logo appears for approx. 30 seconds, then the "Initial settings" menu appears automatically.
- You can change these settings at any time (see the "Basic settings" chapter).

Setting the language

The default language appears in the display.

- 1 Select the desired display language with the rotary selector.
- 2 Confirm with ✓.

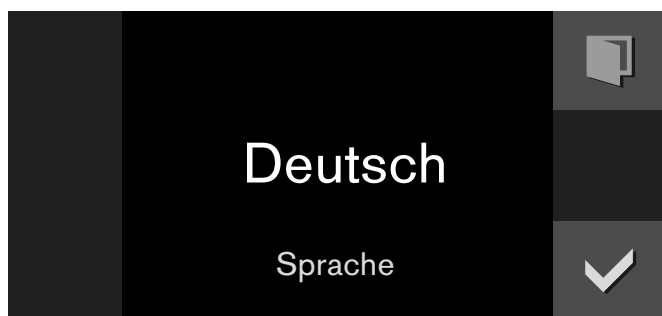

Note: When the language is changed, the system is restarted; this procedure takes a few seconds.

Setting the time format

the two possible formats 24h and AM/PM appear in the display. The default format is 24h.

- 1 Set the required format with the rotary selector.
- 2 Confirm with ✓.

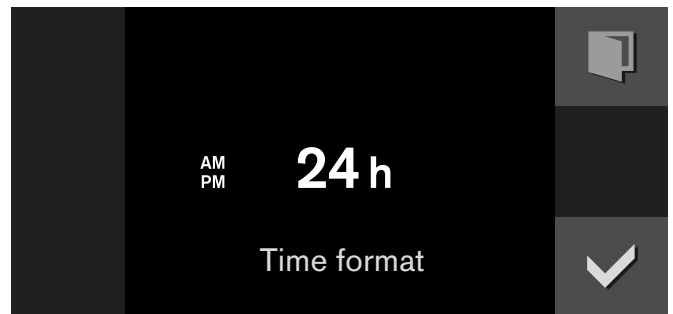

Setting the time

The time appears in the display.

- 1 Set the required time with the rotary selector.
- 2 Confirm with ✓.



Setting the date format

The three possible formats D.M.Y, D/M/Y and M/D/Y appear in the display. The D.M.Y is the default.

- 1 Set the required format with the rotary selector.
- 2 Confirm with ✓.

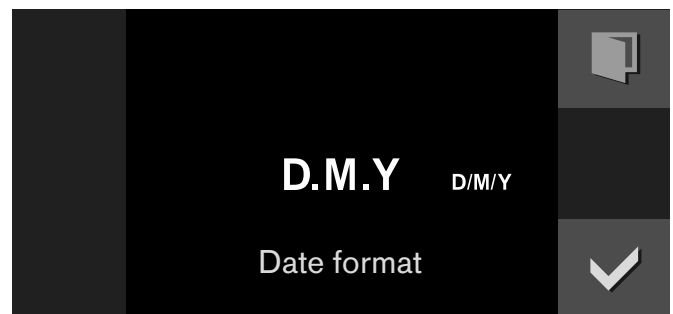

Setting the date

The default date appears in the display. The day setting is already active.

- 1 Set the required day with the rotary selector.
- 2 Switch to the month setting with the > symbol.
- 3 Set the month with the rotary selector.
- 4 Switch to the year setting with the > symbol.
- 5 Set the year with the rotary selector.
- 6 Confirm with ✓.

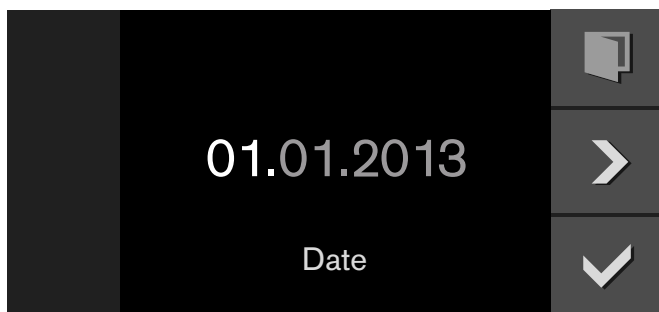

Setting the temperature format

The two possible formats °C and °F appear in the display. The °C format is selected by default.

- 1 Set the required format with the rotary selector.
- 2 Confirm with ✓.

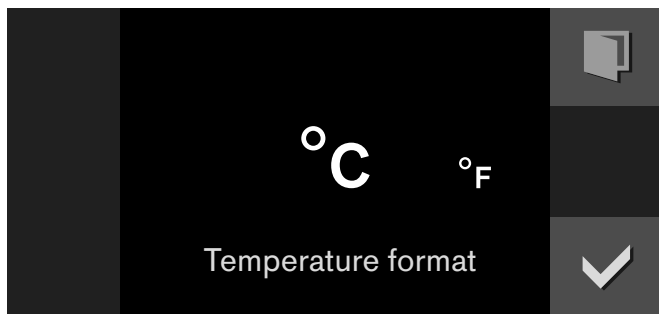

Completing initial set-up

"Initial set-up complete" appears in the display.

Confirm with ✓.

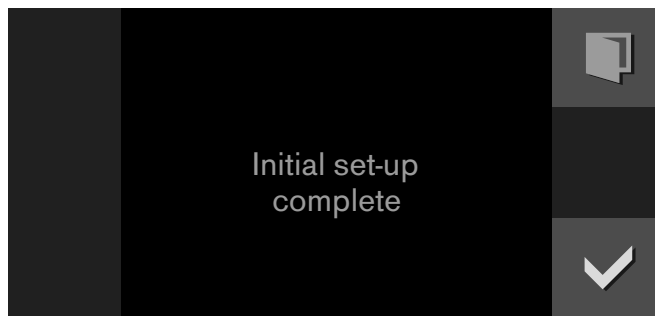

The appliance enters the standby mode and the standby display appears. The appliance is now ready for operation.

Heating up the oven

Make sure there are no packaging remainders left in the interior.

Heat up the empty, closed oven to dispel the 'new' smell. An hour with convection  at 390° F (200° C) is ideal. For details of how to set this heating function, refer to the section entitled ***Operating the appliance.***

Cleaning accessories

Before using accessories for the first time, thoroughly clean them with hot soapy water and a soft dish cloth.

Activating the appliance

Standby

The appliance is in the standby mode when no function is set or the child lock is activated.

The control panel's brightness is reduced in the standby mode.



Notes

- There are various displays for the standby mode. The GAGGENAU logo and the time are set by default. Refer to the section entitled **Factory setting** if you would like to change the display.
- The display's brightness depends on the vertical viewing angle. You can adjust the display by way of the "Brightness" setting in the factory settings.

Activate appliance

In order to exit standby mode, you can either

- Set the function selector,
- Touch a control panel,
- or open or close the door.

Now you can set the desired function. Read the appropriate chapters to learn how to set functions.

Notes

- If "Standby screen = off" is selected in the factory setting, you must turn the function selector to exit the standby mode.
- The standby display appears again if you have not made any settings for a long while after activation.
- The cooking compartment lighting goes out after a little while if the door is open.

Operating the appliance

Oven interior

The cooking compartment has five shelf levels.

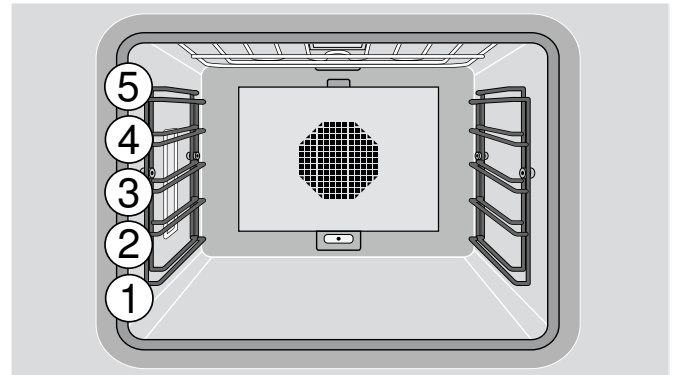

⚠ CAUTION

Do not place anything on the cooking compartment floor. Do not cover it with aluminium foil. A build-up of heat could damage the appliance or cause injury.

⚠ CAUTION

Do not slide any accessories between the shelf positions, or they may tip.

Inserting the rack

The accessories feature a rack stop function. The rack stop function prevents tilting of accessories when pulling them out. You must insert accessories in the oven interior correctly so that tilt protection will work.

Inserting the rack

- 1 Tilt the rack to guide the rack stop in between the rails of the rack holders **A**. The rack stop has to face downwards.
- 2 Lower the rack and slide it into the oven, so that the rack stop can engage **B**. Make sure the rack's safety rod is at the rear and top **C**.

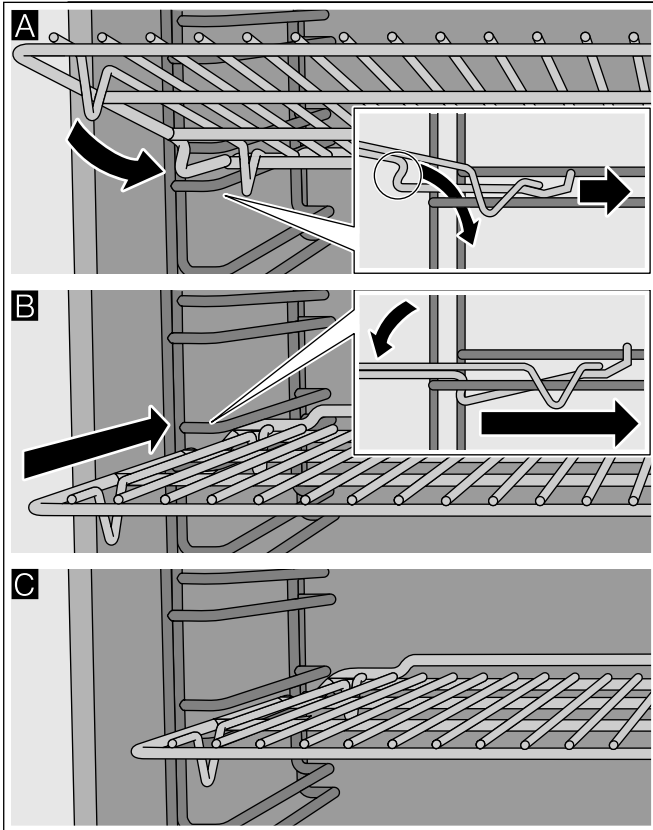

Turning on

- 1 Set the required heating mode using the function selector. The chosen heating mode and the default temperature are displayed.
- 2 If you want to change the default temperature: set the required temperature with the rotary selector.

The preheating symbol \gg appears on the display. The bar continuously shows the preheating status. When the set temperature is reached, a signal sounds and the preheating symbol \gg goes off.

Note: The oven interior lighting stays switched off at a temperature setting below 160° F (70°C).

Switching off:

Turn the function selector to 0.

Quick heat

With the "Quick heat" function, your appliance reaches the desired temperature particularly quickly in the top heat, bottom heat, and top/bottom heat types of heating.

To ensure an even cooking result, do not place your food in the cooking compartment until "Quick heat" is complete and the \gg heat-up symbol goes out.

Note: The "Quick heat" function is preset in the factory settings. In the basic settings, you can select \gg Quick heat or \wedge Heat-up.

Safety shut-off

For your protection, the appliance has a safety shut-off feature. Every heating operation is switched off after 12 hours if the appliance is not operated during this time. A message appears in the display.

Exception:

programming with the long-term timer.

Turn the program selection to 0, after which you can operate the appliance in the manner to which you are accustomed.

Timer functions

In the timer menu, set:

- ⌚ Timer
- ⌚ Stopwatch
- 🕒 Cooking time (not in the idle state)
- 🕒 Cooking time end (not in the idle state)

Launching the timer menu

You can launch the timer menu from any mode. Only from the factory settings, program selection is set to **S**, the time menu is not available.

Touch the ⌚ symbol.

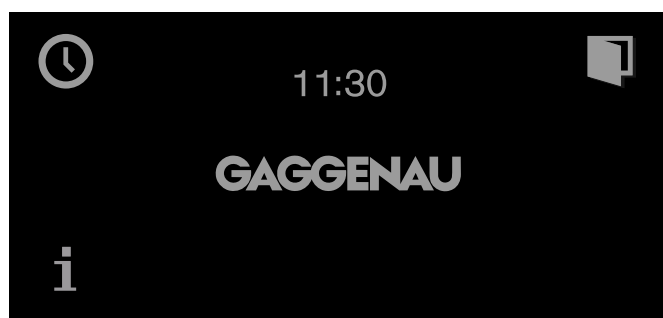

The timer menu appears.

Timer

The timer runs independently of the other appliance functions. You can enter a maximum of 90 minutes.

Setting the timer

- 1 Call up the Timer menu.
The "Timer" function ⌚ is displayed.
- 2 Turn the rotary selector to set the desired time.

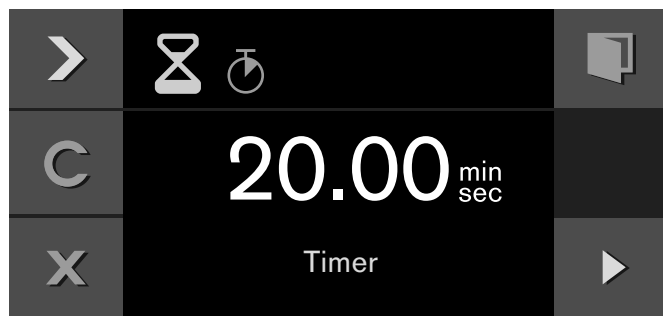

- 3 Start with ▶.

The Timer menu closes and the timer starts to run. The symbol for the timer ⌚ appears on the display and the time can be seen counting down.

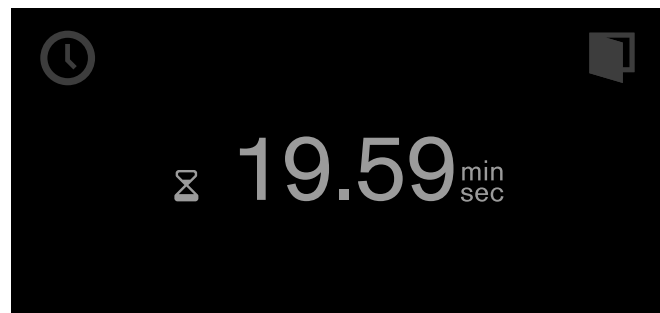

A signal sounds once the time has elapsed. The audible signal ceases if you touch the ✓ symbol.

You can exit the Timer menu at any time by touching the ✕ symbol. This way, the settings are lost.

Suspend timer:

Call up the Timer menu. Select the "Timer" function with >, select ⌚, and touch the || symbol. To let the timer run on, touch the ▶ symbol.

Switch off the timer early:

Call up the Timer menu. Select the "Timer" function with >, select ⌚, and touch the C symbol.

Stopwatch

The stopwatch runs independently of the other appliance functions.

The stopwatch counts up from 0 seconds to 90 minutes.

It has a pause function. Therefore, you can stop the timer in between times.

Starting the stopwatch

- 1 Launch the timer menu.
- 2 With >, select the "Stopwatch" function ⌚.

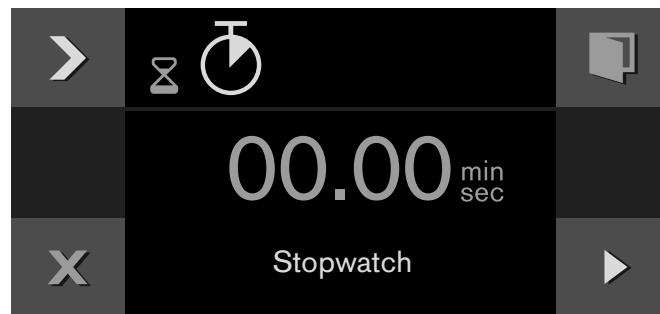

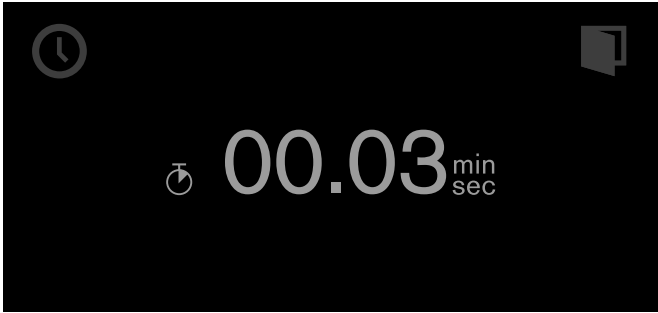

- 3 Start with ▶.

The timer menu is closed and the time runs. The  symbol and the elapsing timer are shown in the display.



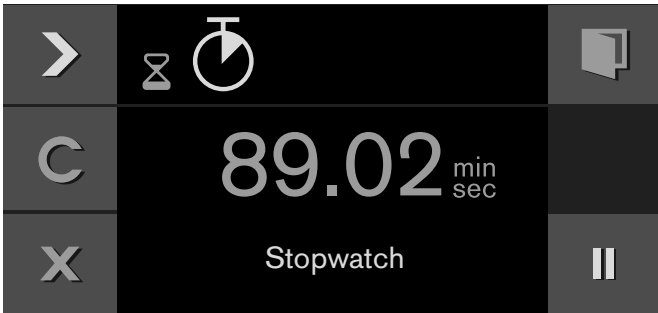

Stopping and restarting the stopwatch

- 1 Launch the timer menu.
- 2 With , select the "Stopwatch" function .
- 3 Touch the  symbol.



The time stops. The symbol changes to Start  again.

- 4 Start with .

The time continues to run. Once 90 minutes have been reached, the display pulsates and a signal sounds. It goes off when you touch the  symbol. The  symbol disappears from the display. The operation has ended.

Switching off the stopwatch:

Launch the timer menu. With , select the "Stopwatch" function  and touch the  symbol.



Cooking time

If you set a cooking time for your meal, the appliance switches off heating automatically after this time has elapsed.

You can set a cooking time from 1 minute to 23:59 hours.

Setting the cooking time

You have set the heating function and temperature and you have placed your dish in the oven interior.

- 1 Touch the  symbol.
- 2 With , select the "Cooking time" function .
- 3 Set the required cooking time with the rotary selector.



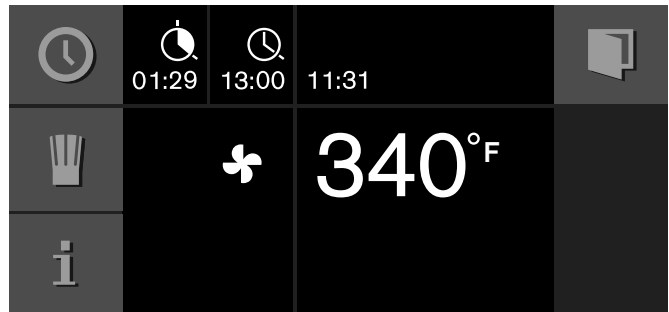

- 4 Start with .

The appliance starts. The timer menu is closed. The temperature, the operating mode, the remaining cooking time and the end of the cooking time appear in the display.



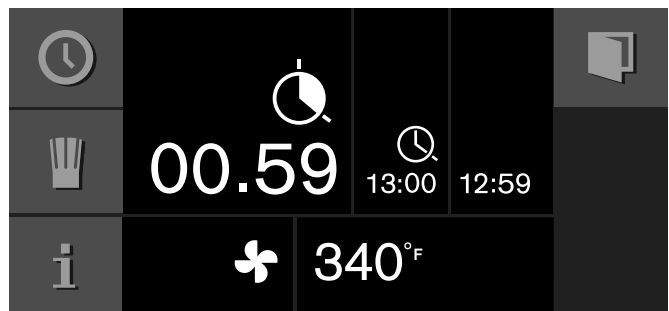



One minute before expiration of the cooking time, the expiring cooking time is enlarged in the display.





The appliance switches off after expiration of the cooking time. The  pulsates and a signal sounds. It goes off prematurely if you touch the  symbol, open the appliance door or set the program selection to 0.





Interrupting the cooking time:

Launch the timer menu. With , select the "Cooking time" function . With  interrupt the cooking time. With  continue the cooking time.

Changing the cooking time:

Launch the timer menu. With , select the "Cooking time" function . Set the cooking time with the rotary selector. Start with .

Clearing the cooking time:

Launch the timer menu. With , select the "Cooking time" function . Clear the cooking time with . Return to normal operation with .

Canceling the entire operation:

Set the program selection to 0.

Note: You can also change the heating function and temperature during the cooking time.

End of cooking time

You can defer the end of the cooking time until later.



Example: it is 2 pm. The meal takes 40 minutes to cook. It should be ready by 3.30 pm.

Enter the cooking time and shift the end of the cooking time to 3.30 pm. The electronic circuitry calculates the starting time. The appliance starts automatically at 2:50 pm and switches off at 3.30 pm.

Note that easily perishable foodstuffs must not be left in the oven for too long.

Shifting the end of the cooking time

You have set the heating function, the temperature and the cooking time.

- 1 Touch the  symbol.
- 2 With , select the "End of cooking time" function .



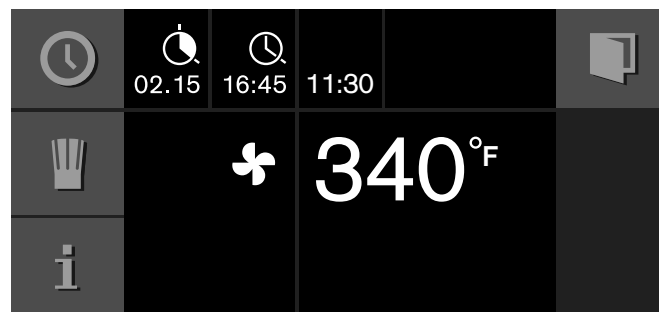

- 3 Set the required cooking time end with the rotary selector.
- 4 Start with .





The appliance assumes a waiting mode. The operating mode, the temperature, the cooking time and the end of the cooking time appear in the display. The appliance starts at the calculated time and switches off automatically when the cooking time has elapsed.

Note: If the  symbol flashes: you have not set a cooking time. Always set a cooking time first.

The appliance switches off after expiration of the cooking time. The  pulsates and a signal sounds. It goes off prematurely if you touch the  symbol, open the appliance door or set the program selection to 0.

Changing the cooking time end:

Launch the timer menu. With , select "End of cooking time" . Set the required cooking time end with the rotary selector. Start with .

Canceling the entire operation:

Set the program selection to 0.

Sabbath mode and Yom Tov mode

Sabbath mode

With this function, the appliance maintains a temperature between 120 and 450°F (50 and 230°C) with the convection heating function.

You can keep dishes warm for up to 74 hours without having to switch on or off.

Note that easily perishable foodstuffs must not be left in the oven for too long.

Note: You must activate the Sabbath mode in the factory setting in order to operate the mode.

Follow these steps:

- 1 Set the program selector to **S**.
- 2 Select "Factory setting" with the rotary selector.
- 3 Confirm by touching the ✓ symbol.
- 4 Rotate the selector to Sabbath mode (🕒).
- 5 Confirm by touching the ✓ symbol.
- 6 Rotate the selector to "activate".
- 7 Confirm by touching the ✓ symbol.
- 8 Turn the oven off.

Setting the Sabbath mode

- 1 Set the program selector to 🕒.
- 2 Touch the 🕒 symbol.
The suggested value of 24h at 185° F (85° C) appears in the display. Start with ▶
- or -
Change the cooking time and the temperature.



- 3 Changing the cooking time 🕒 :
Touch the 🕒 symbol. Set the preferred cooking time with the rotary selector. You can set up to 74 hours. Confirm by touching the ✓ symbol. Then changing the temperature becomes an option.
- 4 Changing the temperature:
Set the required temperature with the rotary selector.
- 5 Start with ▶ .

The appliance starts. 🕒 and the temperature appear in the display. The Sabbath screen will appear as shown.



The oven and display lighting is off. The control panel is blocked and no tone can be heard when you touch it.

The appliance no longer heats after expiry of the time. The display is blank. Set the program selector to **0**.

Switching off:

To cancel the operation, set the program selector to **0**.

Yom Tov mode

With this function, the appliance is programmed to perform in three stages.

Stage 1 and 2 can be programmed for a maximum total duration of 74 hours. The duration of Step 3 is 1 hour and cannot be modified.



Stage 1: maintains a warm temperature of 122° F (50°C) in the convection heating function. The interior oven lights remain off through this stage.

Stage 2: the appliance raises to a desired temperature setting and maintains a temperature between 120 and 450° F (50 -230°C). For warming and cooking foods in the convection heating function. The desired time can be adjusted for this stage. The interior oven lights will be on during this time.

Stage 3: maintains a warm temperature of 122° F (50°C) in the convection heating function for 1 hour after stage 2 has ended. The interior oven lights will be on during this time.





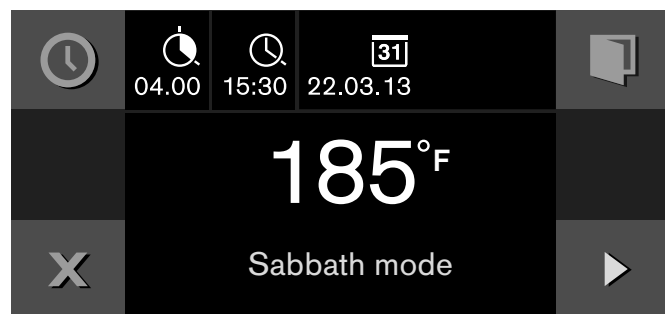

Note that easily perishable foodstuffs must not be left in the oven for too long.

Setting the Yom Tov mode

- 1 Set the program selector to .
- 2 Touch the  symbol.
The suggested value of 24h at 185° F (85° C) appears in the display.



To set Stage 2 cooking time with rotary selector:

- 1 Touch the  symbol to adjust the duration of Stage 2 cooking time .
- 2 Set the desired Stage 2 cooking time with the rotary selector.
- 3 Touch the  symbol to adjust the end of Stage 2 cooking time .
- 4 Select the end time with the rotary selector.
- 5 Change the date if needed by touching the  symbol to .
- 6 Rotate the selector to the desired date.
- 7 Confirm settings by touching the  symbol.

To set Stage 2 temperature:

- 1 Rotate selector to desired Stage 2 temperature.
- 2 Start with .

The temperatures of Stage 1 and Stage 2 appear in the display. The remaining time to the beginning of Stage 2 is counted down in the display. The Yom Tov screen will appear as shown.

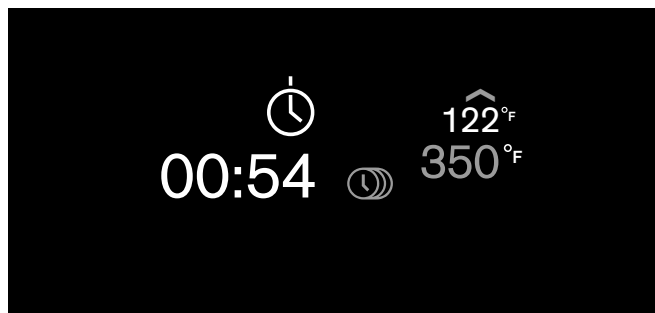

The program will begin with the pre-set warm temperature without light, then advance to the programmed temperature with light until the end of the set date and time, and then maintain the pre-set warm temperature for 60 minutes.

The appliance no longer heats after expiry of the time. The display is blank. Set the program selector to 0.

Switching off:



To cancel the operation, set the program selector to 0.

Personal recipes

You can save up to 50 individual recipes. You can record a recipe. You can assign these recipes a name so that you can fall back on them quickly and conveniently if you need them.

Recording a recipe

You can set up to five phases in succession and you can record them.

- 1 Set the program selection to the required heating function.
The  symbol is displayed.
- 2 Touch the  symbol.
- 3 Choose a free storage location with the rotary selector.
- 4 Touch the  symbol.

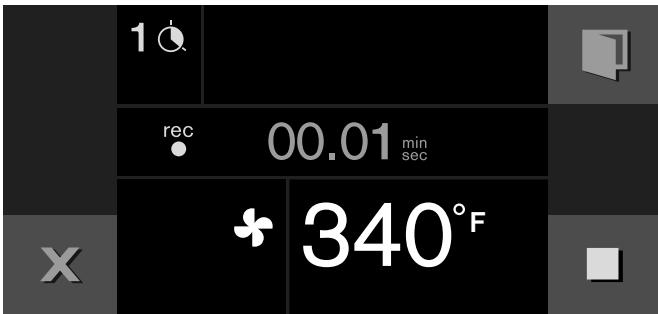



- 5 Set the desired temperature with the rotary selector.
- 6 The cooking time is recorded.
- 7 Recording another phase:
Set the program selection to the required heating function. Set the required temperature with the rotary selector. A new phase begins.
- 8 Once the appliance has achieved the desired cooking result, touch the  symbol to end the recipe.
- 9 Enter the name under "ABC" (see Section entitled *Entering names*).

Notes





- Recording a phase does not begin until the appliance has reached the set temperature.
- Every phase must last at least one minute.
- During the first minute you can change the heating function or the temperature.

Enter the core temperature for a phase:





Insert the core temperature probe in the socket in the oven interior. Set the heating function and temperature. Touch the  symbol. With the rotary selector, enter the required temperature and confirm it with .

Programming a recipe

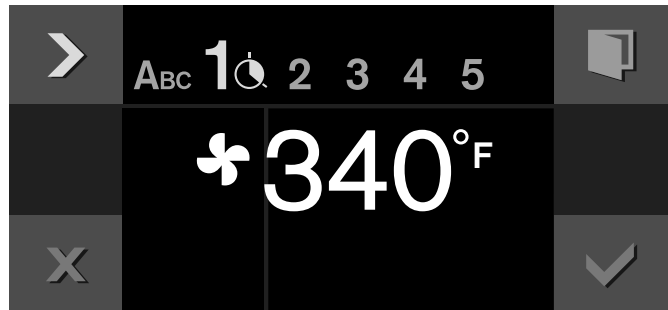

You have the option of programming and saving up to five phases of preparation.

- 1 Set the program selection to the required heating function. Set the required temperature with the rotary selector.
The  symbol is displayed.
- 2 Touch the  symbol.
- 3 Choose a free storage location with the rotary selector..
- 4 Touch the  symbol.
- 5 Enter the name under "ABC" (see Section entitled *Entering names*).
- 6 Choose the first phase with the  symbol.
The heating function and temperature set at the start are displayed. You can change the heating function and temperature with the rotary selectors.



- 7 Choose the time setting with the  symbol.
- 8 Set the required cooking time with the rotary selector.
- 9 Choose the next phase with the  symbol.
- or -
Preparation is complete, end input.
- 10 Save with .
- or -
Cancel with  and quit the menu.

Enter the core temperature for a phase:

Choose the next phase with the  symbol. Set the heating function and temperature. Touch the  symbol. With the rotary selector, enter the required temperature and confirm it with .

Note: For phases for which a core temperature has been programmed you cannot set a cook time.

Entering a name

- 1 Enter the recipe's name under "ABC".

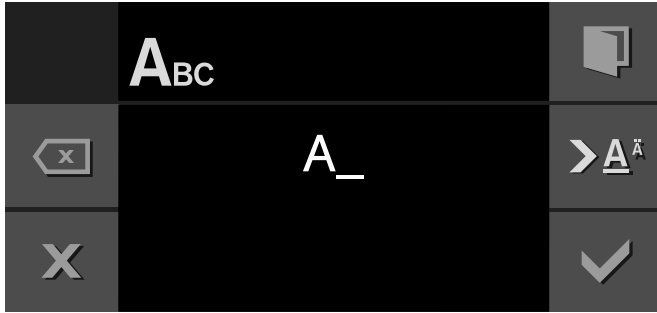

Rotary selector	Selecting letters A new word always begins with an upper case letter.
>A ^ä	Press briefly: cursor to the right Press long: switch to diacritics and special characters Press twice: insert line space
>Ä	Press briefly: cursor to the right Press long: switch to normal characters Press twice: insert line space
⊗	Clear letters

- 2 Save with ✓.
- or -
Cancel with X and quit the menu..

Note: For entering a name, Latin characters, certain special characters and numbers are available.

Starting a recipe

- 1 Set the program selection to any heating function. The 🍷 symbol is displayed.
- 2 Touch the 🍷 symbol. Set the required recipe with the rotary selector.
- 3 Start with ▶.
Operation begins. Its duration elapses visibly. The settings of the phases appear in the display bar.

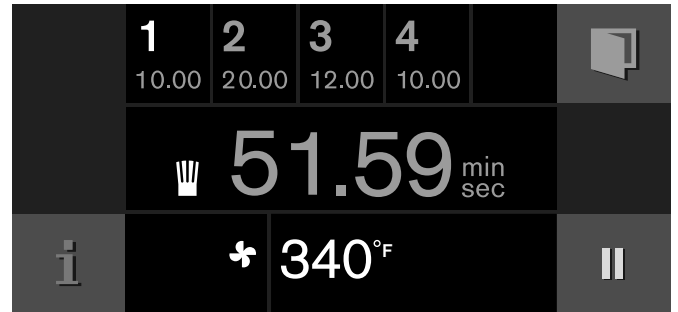

Notes

- The cooking time does not start counting down until the appliance has reached the set temperature.
- You can use the rotary selector to change the temperature while the recipe is in progress. This does not change the saved recipe.

Deleting a recipe

- 1 Set the function selector to any type of heating. The 🍷 symbol is displayed.
- 2 Touch the 🍷 symbol.
- 3 Use the rotary selector to select the desired recipe.
- 4 Delete the recipe with C.
- 5 Confirm with ✓.

Core temperature probe

The core temperature probe enables exact cooking to the spot. It measures the temperature inside the food being cooked. Automatic switching off when the desired core temperature is reached ensures that each cooked food is cooked precisely.

Use the included core temperature probe only. You can purchase one as a spare part from after-sales service or in the online shop.

The core temperature probe is damaged at temperatures above 480°F (250°C). Therefore, only ever use it in your appliance at a maximum temperature setting of 445°F (230°C).

Always remove the core temperature probe from the oven interior after use. Never store it in the oven interior.

After every use, clean the core temperature probe with a moist cloth. Do not wash it in a dishwasher!

⚠ WARNING

Risk of electric shock

Use of a wrong core temperature probe can damage the insulation. Use only the core temperature probe intended for this appliance.

⚠ WARNING

Risk of burns

The oven interior and the core temperature probe become very hot. Use oven mitts to plug and unplug the core temperature probe.

Insert the core temperature probe in the food to be cooked

Insert the core temperature probe in the food to be cooked before you place it in the oven interior.

Insert the metal tip at the thickest point in the food you are cooking. Make sure that the end of the tip is approximately in the center. It must not be placed in the fat and must not touch any cookware or bones.

If there are several pieces, insert the core temperature probe in the middle of the thickest piece.

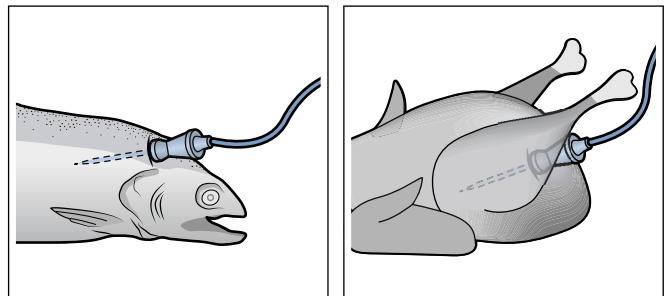
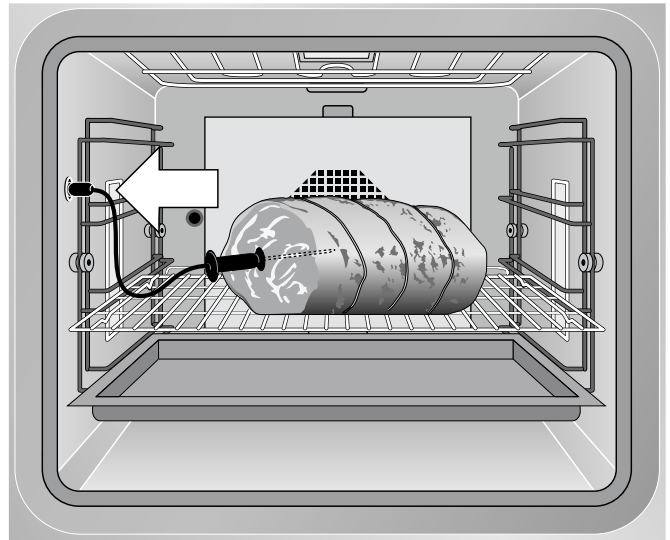

Insert the core temperature probe completely, if possible.

In the case of poultry, make sure that the tip of the core temperature probe is not in the cavity in the center, but in the meat between the belly and upper leg.



When using with bread, insert the core temperature probe into the coldest part of the bread only after baking for 10–15 minutes. The core temperature probe pierces the crust, but does not sink into the dough. Continue baking the bread until the desired core temperature is reached.

Setting the core temperature

- 1 Insert food into the oven interior with the core temperature probe inserted. Insert the core temperature probe in the socket in the oven interior and close the appliance door.
Do not jam the core temperature probe's cable!  and the current core temperature appear in the display.
- 2 Set the program selection to the required heating function.
- 3 Set the oven interior temperature with the rotary selector.
- 4 Touch the  symbol. With the rotary selector, set the required core temperature and confirm it with .
The set core temperature must be higher than the current core temperature.

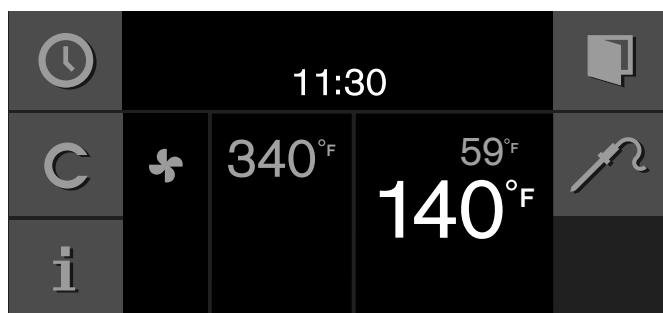



- 5 The appliance heats with the set heating function. The current core temperature is displayed and, under it, the set core temperature.
You can change the set core temperature at any time.

A signal sounds when the set core temperature in the food has been reached. The cooking mode is ended automatically. Confirm with  and turn the program selection to **0**.

Notes

- The measurable range is 59 to 210° F (15 to 99° C). Outside the measurable range, "--°F" is displayed for the current core temperature.
- If you leave the food in the cooking compartment for some time after cooking, the core temperature will continue to rise somewhat due to the residual heat in the cooking compartment.
- If at the same time you adjust a programming with the core temperature probe and the cooking time timer, then the programming switches the device off that reaches the specified value first.

Changing the core temperature set:

Touch the  symbol. Use the rotary selector to change the set core temperature for the food and confirm with .

Deleting the core temperature set:

Touch the  symbol. Delete the set core temperature with **C**. The appliance continues heating in normal cooking mode.

Core temperature guidelines

Use chilled food only, not frozen food. The details given in the table are guidelines. Results depend on the quality and composition of the food.

For hygiene reasons, critical foodstuffs such as fish and game should reach a core temperature of 143 - 158° F (62 - 70 °C); for poultry and minced meat this should be as high as 176 - 185° F (80 - 85 °C).

Food	Core temperature guideline
Beef	
Sirloin, tenderloin, entrecôte	
very rare	113 - 117° F (45 - 47 °C)
rare	122 - 126° F (50 - 52 °C)
medium	137 - 140° F (58 - 60 °C)
well-done	158 - 167° F (70 - 75 °C)
Roast beef	176 - 185° F (80 - 85 °C)
Pork	
Pork roast	162 - 176° F (72 - 80 °C)
Pork loin	
medium	149 - 158° F (65 - 70 °C)
well-done	167° F (75 °C)
Meat loaf	185° F (85 °C)
Fillet of pork	149 - 158° F (65 - 70 °C)
Veal	
Veal roast, well-done	167 - 176° F (75 - 80 °C)
Breast of veal, stuffed	167 - 176° F (75 - 80 °C)

Food	Core temperature guideline
Saddle of veal	
medium	137 - 140°F (58 - 60 °C)
well-done	149 - 158°F (65 - 70 °C)
Fillet of veal	
rare	122 - 126°F (50 - 52 °C)
medium	137 - 140°F (58 - 60 °C)
well-done	158 - 167°F (70 - 75 °C)
Game	
Saddle of venison	140 - 157°F (60 - 70 °C)
Leg of venison	158 - 167°F (70 - 75 °C)
Venison loin steaks	149 - 158°F (65 - 70 °C)
Saddle of hare or rabbit	149 - 158°F (65 - 70 °C)
Poultry	
Chicken	185°F (85 °C)
Guinea fowl	167 - 176°F (75 - 80 °C)
Goose, turkey, duck	176 - 185°F (80 - 85 °C)
Duck breast	
medium	131 - 140°F (55 - 60 °C)
well-done	158 - 176°F (70 - 80 °C)
Ostrich steak	140 - 149°F (60 - 65 °C)
Lamb	
Leg of lamb	
medium	140 - 149°F (60 - 65 °C)
well-done	158 - 176°F (70 - 80 °C)
Saddle of lamb	
medium	131 - 140°F (55 - 60 °C)
well-done	149 - 167°F (65 - 75 °C)

Food	Core temperature guideline
Mutton	
Leg of mutton	
medium	158 - 167°F (70 - 75 °C)
well-done	176 - 185°F (80 - 85 °C)
Saddle of mutton	
medium	158 - 167°F (70 - 75 °C)
well-done	176 °F (80 °C)
Fish	
Fillet	144 - 149°F (62 - 65 °C)
Whole	149°F (65 °C)
Terrine	144 - 149°F (62 - 65 °C)
Other provisions	
Bread	205°F (96 °C)
Paté	162 - 167°F (72 - 75 °C)
Terrine	140 - 158°F (60 - 70 °C)
Foie gras	113°F (45 °C)

Rotisserie spit

Using the rotisserie spit, you can prepare large roasts such as rolled roast and poultry particularly well. The meat becomes crispy and brown all round.

You can use the rotisserie spit in all modes of operation. You achieve the best results with the "Broil" or "Top heat" heating functions.

⚠ CAUTION

Do not use the temperature probe in combination with the rotisserie spit.

Preparation

- 1 Insert both supports in the sockets on the grill tray. The drive is on the left.
- 2 Plug the right retaining clip onto the rotisserie spit and screw it in firmly.
- 3 Place the food you want to cook on the rotisserie spit's center. Secure protruding parts (e.g. wings) to make sure they do not touch the grill heating element.

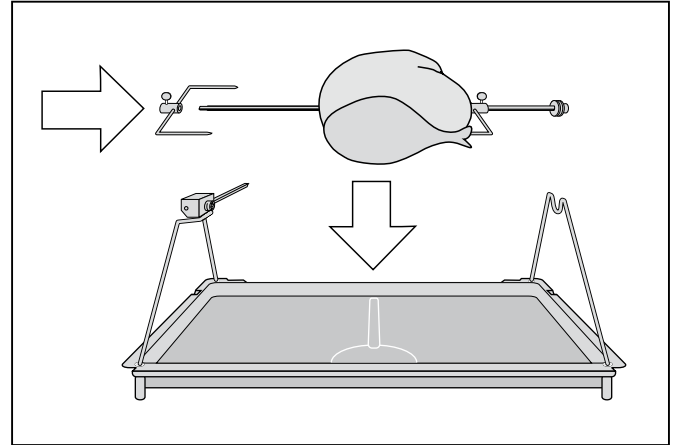

- 4 Plug the left retaining clip onto the rotisserie spit and screw it in firmly.
- 5 Place the rotisserie spit on the supports. Latch the square shaft into the drive section.

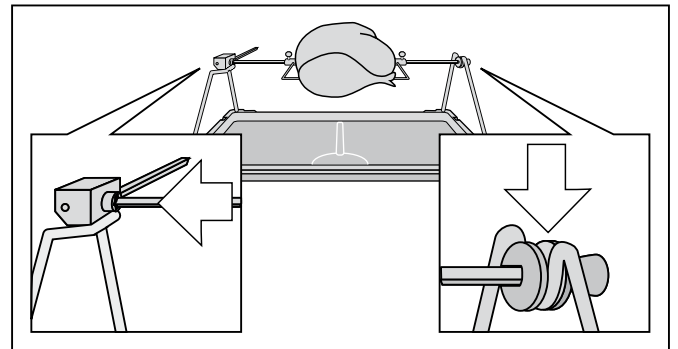

- 6 Insert the rotisserie spit in the lowest insertion level in the oven. The drive spindle must engage in the opening on the oven's rear wall.

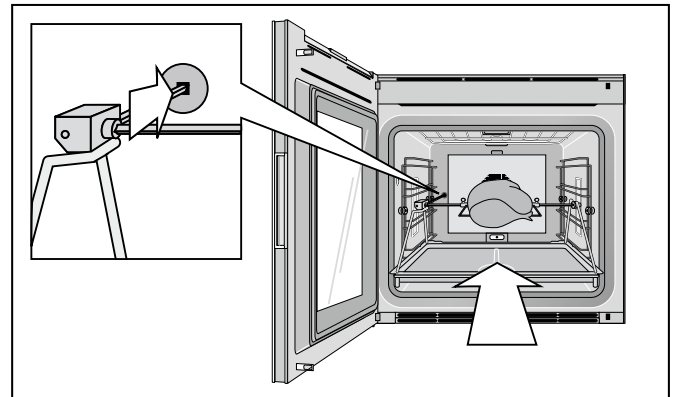

Switching on the rotisserie spit

- 1 Set the required temperature and heating function.
- 2 Touch the  symbol. The rotisserie spit is switched on.

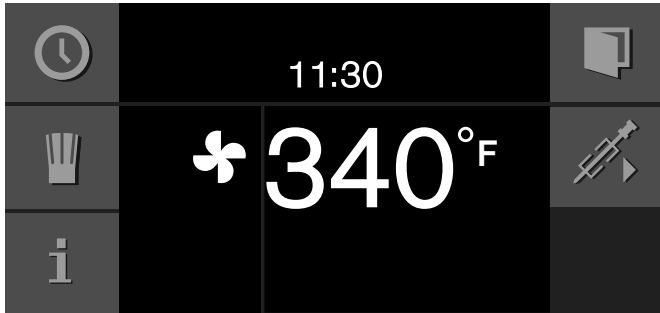

Switching off the rotisserie spit

- 1 Touch the  symbol. The rotisserie spit's drive stops.
- 2 Switch off the oven with the program selection.
- 3 Take out the grill tray with the rotisserie spit and place them on a stable, heat-resistant surface.



WARNING

Risk of burns

Use a glove to remove them.

- 4 Screw on the handle at the side to remove the rotisserie spit.

Notes

- Use the rotisserie spit at oven temperatures up to 480° F (250°C) only.
- Do not clean the drive part of the rotisserie spit in a dishwasher.

Roasting function

Only with heating type "Roaster operation":
In the pre-roast stage, the oven heats at full power for approx. 3 minutes. This way, you can cook steaks quickly.

Touch the **>>** symbol. The pre-roast stage starts up. You can also set the pre-roast feature several times one after another.

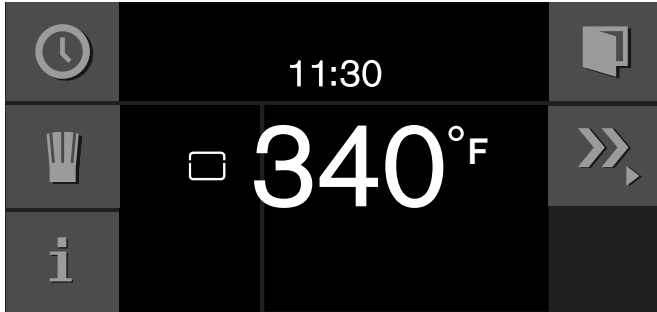

To end the pre-roast stage early, touch **>>**.

Child lock

The appliance has a child lock to make sure children cannot operate it inadvertently.

Notes

- You must set the child lock in the factory setting to "Available" (see section entitled 'Factory setting').
- If there is a power cut while the child lock is activated, it may be deactivated when the power returns.

Activating the child lock

Requirement:

Program selector is set to 0.

Touch the **🔒** symbol for at least 6 seconds.

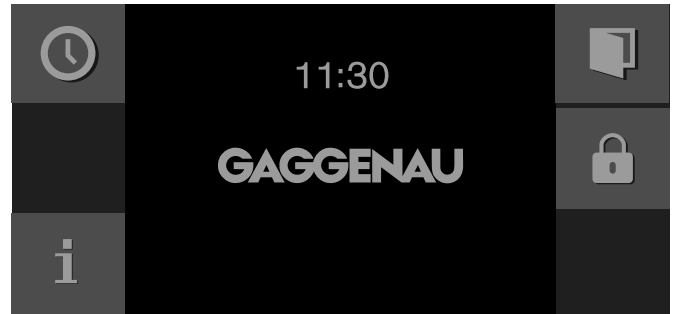

The child lock is activated. The standby screen appears. The **🔒** appears at the top of the display.

Deactivating the child lock

Requirement:

Program selector is set to 0.

Touch the **🔓** symbol for at least 6 seconds.

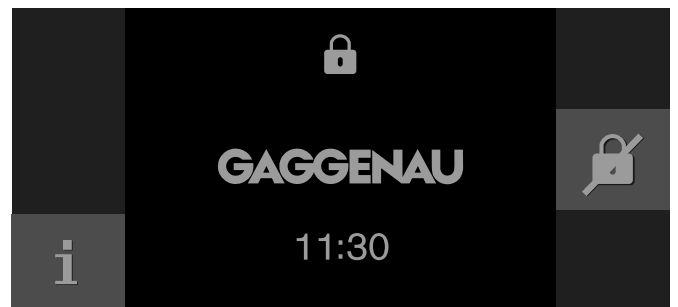

The child lock is deactivated. You can switch on the appliance in the usual manner.











Factory setting











In the general settings, you can adapt your appliance individually.

- 1 Set the program selector to **S**.
- 2 Select "General setting" with the rotary selector.
- 3 Touch the ✓ symbol.
- 4 Set the required general setting with the rotary selector.

- 5 Touch the ↘ symbol.
- 6 Set the general setting with the rotary selector.
- 7 Save with ✓ or cancel with ✕ and quit the current general setting.
- 8 Turn the program selector to **0** to quit the general setting menu.

Changes are saved.

	Basic setting	Possible settings	Explanation
	Brightness	Stages 1, 2, 3, 4, 5*, 6, 7, 8	Setting display brightness
	Standby screen	On*/Off - Clock - Clock + GAGGENAU logo* - Date - Date + GAGGENAU logo - Clock + date - Clock + date + GAGGENAU logo	Appearance of the standby screen. Off: no display. Use this setting to reduce the standby consumption of your appliance. On: several displays can be set, confirm "On" with ✓ and choose the desired display with the rotary selector. The selection is displayed.
	Display screen	Minimized*/Standard	When 'Minimized' is set, only the most important details are displayed after a short time.
	Touchpad color	Gray*/White	Select the color of symbols on the touchpads
	Touchpad tone	Tone 1*/Tone 2/Off	Select the signal tone when touching a touchpad
	Touchpad volume	Levels 1, 2, 3, 4, 5*, 6, 7, 8	Sets the volume of the touchpad tone
	Preheating speed/signal	Preheating with signal Quick heat with signal* Preheating without signal Quick heat without signal	The audible signal sounds when the desired temperature is reached during preheating. With quick heat, the desired temperature is reached especially fast.
	Signal volume	Levels 1, 2, 3, 4, 5*, 6, 7, 8	Sets the volume of the signal tone
	Time format	AM/PM / 24 h*	Time display in 24 or 12-hour format
	Time	Current time	Setting the time
	Daylight savings	Manual*/Automatic	Automatic time changeover when changing daylight savings time. If automatic: setting of the month, day and week when the time is to be changed. To be set separately for summer and winter time.

	Date format	D.M.Y* D/M/Y M/D/Y	Setting the date format
	Date	Current date	Setting the date. Switch between the year/month/day with the > symbol.
	Temperature format	°C*/°F	Set the temperature unit
	Language	German* / French / Italian / Spanish / Portuguese / Dutch / Danish / Swedish / Norwegian / Finnish / Greek / Turkish / Russian / Polish / Czech / Slovenian / Slovakian / Arabic / Hebrew / Japanese / Korean / Thai / Chinese / English US / English	Select language for the text display Note: When the language is changed, the system is restarted; this procedure takes a few seconds. Then the General settings menu is closed.
	Factory settings	Restore appliance to factory settings	Confirm the question "Delete all individual settings and restore appliance to factory settings?" with ✓ or cancel with X. Note: When restoring factory settings, the personal recipes are also deleted. After restoring the factory settings, you will see the "Initial settings" menu.
	Demo mode	On/Off*	For presentation purposes only. The appliance does not heat in the demo mode, but all other functions are available. The "Off" setting must be activated for normal operation. The setting is only possible in the first three minutes after connecting the appliance.
	Sabbath mode	Not Available* / Available	Available: Sabbath mode can be set; see the section entitled 'Sabbath mode'.
	Door lock	Off*/On	The door lock prevents unintentional opening of the appliance door. When "On" is set, you must touch the  symbol for several seconds before the door opens.
	Child lock	Not Available* / Available	Available: the child lock can be activated (see section entitled 'Child lock').

* Factory settings

Cleaning and maintenance

If taken care of and cleaned conscientiously, your appliance will stay beautiful and intact for a long time. Here we explain how to take care of and clean your appliance correctly.

WARNING

Risk of electrical shock

Moisture entering the appliance can cause an electrical shock. Don't use a high-pressure cleaner or steam cleaner.

WARNING

Risk of burns

- To avoid risk of injury, never touch the inside surfaces of the oven interior or heating elements. These surfaces are extremely hot after use. Always allow the appliance to cool down before touching or cleaning the interior.
 - Always turn off the interior light before cleaning the oven to allow the bulbs to cool down. The bulbs can become very hot when switched on. Keep the light off while cleaning the oven.
 - Keep children away.
-

WARNING

Risk of injury

Scratched glass in the appliance door can burst. Do not use any glass scrapers or strong or abrasive cleaning agents.

WARNING

Do not clean the appliance while it is still hot. Some cleaners produce noxious fumes when applied to a hot surface. Wet clothes and sponges can cause burns from steam.

Cleaning agents

Pay attention to the information in the table to ensure that the various surfaces are not damaged by incorrect cleaning agents.

Do not use any

- sharp or abrasive cleaning agents
- metal or glass scrapers to clean the glass on the appliance door.
- metal or glass scrapers to clean the door seal.
- hard abrasive pads or cleaning sponges.

Thoroughly rinse out new sponge cloths before use.

Area	Cleaning agent
Door panels	Glass cleaner: Clean with a soft cloth or a microfiber cloth. Do not use a glass scraper.
Display	Wipe down using a microfiber cloth or a slightly damp cloth. Do not wipe with a wet cloth.
Stainless steel	Hot soapy water: Clean with a dish cloth and dry with a soft cloth. Remove flecks of lime scale, grease, starch, and albumin (e.g., egg white) immediately. Corrosion can form under such flecks. Special stainless steel cleaning agents are available from customer service or from specialist retailers.
Aluminum	Clean with a mild window cleaning agent. Using a window cloth or a lint-free microfiber cloth, wipe over the surfaces lightly in a horizontal direction.
Cooking compartment	Hot soapy water: Clean with a dish cloth and dry with a soft cloth.
Very dirty cooking compartment	Cleaning gel spray for oven (order number 00311860 from customer service or in the online shop). Please note: <ul style="list-style-type: none">● Must not come into contact with the door seal.● Soak for a max. of 12 hours.● Do not use on hot surfaces.● Rinse thoroughly with water.● Observe the manufacturer's instructions.
Glass cover for the cooking compartment light	Hot soapy water: Clean with a dish cloth.
Door seal Do not remove.	Hot soapy water: Clean with a dish cloth, do not scour. Do not use a metal or glass scraper for cleaning.
Core temperature sensor	Wipe with a damp cloth. Do not place in the dishwasher.

Area	Cleaning agent
Accessories	Hot soapy water: Soak and clean with a dish cloth or brush.
Plug-in grids	Dishwasher, see section entitled "Removing the plug-in grids"
Rotary spit (not available with all oven models)	Hot soapy water: Clean with a dish cloth or brush. Do not soak or clean the rotary spit drive in the dishwasher.
Telescopic shelf (Special accessories)	Hot soapy water: Clean with a dish cloth or brush. Do not soak or clean in the dishwasher.
Baking stone (Special accessories)	Clean burnt-on residues with a brush. Never clean the baking stone when it is wet.
Roasting dish (Special accessories)	Hot soapy water: Soak and clean with a dish cloth or brush. Do not clean roasting pan in the dishwasher.

Microfiber cloth

The honeycomb microfiber cloth is particularly suitable for cleaning sensitive surfaces such as glass, glass ceramic, stainless steel or aluminum (product no. 00460770, also available from our online online shop). It removes liquid and greasy deposits in one go.

Removing slide-in racks

You can remove the slide-in racks for cleaning.

Removing slide-in racks

- 1 Place a dish cloth in the oven interior to protect the enamel against scratches.
- 2 Undo the knurled nuts (Figure A).
- 3 Detach the slide-in racks (Fig. B).

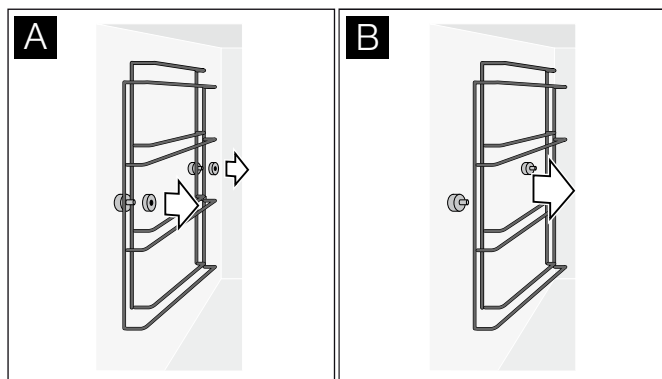

You can clean the slide-in racks in a dishwasher.

Hooking in slide-in racks

- 1 Fit slide-in racks the right way round: with the longer side pointing up. The left and right-hand racks are identical.
- 2 Tighten the knurled nuts.

Self-clean (pyrolysis)

During self-clean (pyrolysis), the oven heats up to 905°F (485°C). Thus, remainders from roasting, grilling or baking are burnt up and all you have to do is wipe the ash out of the interior.

Self-clean (pyrolysis) takes three hours. You can move the self-clean switch-off time (for example, if you would like it to run at night).

⚠ WARNING

During the elimination of soil during self-cleaning, small amounts of Carbon Monoxide can be created and the fiberglass insulation could give off very small amounts of formaldehyde during the first several cleaning cycles. To minimize exposure to these substances, provide good ventilation with an open window, or use a ventilation fan or hood.

Wipe out excessive spillage before self-cleaning the oven.

⚠ WARNING

Risk of fire

The appliance becomes very hot during pyrolytic self-cleaning. Never hang flammable items such as dishcloths on the door handle. Keep the front of the appliance clear. Keep children away.

⚠ WARNING

Severe health risk

The appliance becomes very hot during pyrolytic self-cleaning. The non-stick coatings on trays and forms are destroyed and toxic gases are produced. Never leave trays and forms with non-stick coatings in the oven during pyrolytic self-cleaning. Only leave enameled accessories in oven during self-clean cycle.

Do not clean parts or accessories in the self-clean oven.





Preparing the pyrolytic self-cleaning feature

CAUTION

Risk of fire! Loose food remnants, fat and meat juices may catch fire. Wipe the cooking compartment with a damp cloth.

- Remove the worst soiling and food residues from the oven.
- Clean the door seals, the inside of the door and the glass pane by hand as these parts are not cleaned during the pyrolytic self-cleaning cycle.
- Remove any loose parts from inside the cooking compartment. The plug-in grids are pyrolysis-proof. Make sure that nothing is left inside the cooking compartment.
- Bush for the additional heating element at the back of the cooking compartment: Make sure that the cover is in the bush.
- Close the oven door.

Starting self-clean (pyrolysis)

- 1 Set the program selector to **S**.
- 2 The + symbol is displayed. Confirm with .
- 3 The turn-off time for when the self-clean (pyrolysis) will be completed is displayed. If preferred, the turn-off time can be changed with the rotary selector. Confirm with .
- 4 Remove all accessories and coarse soiling from the oven interior. Confirm with .
- 5 Start with . The cleaning time counts down on the screen. If the turn-off time was changed, the time until the self-clean (pyrolysis) starts counts down on the screen. The oven light remains off.

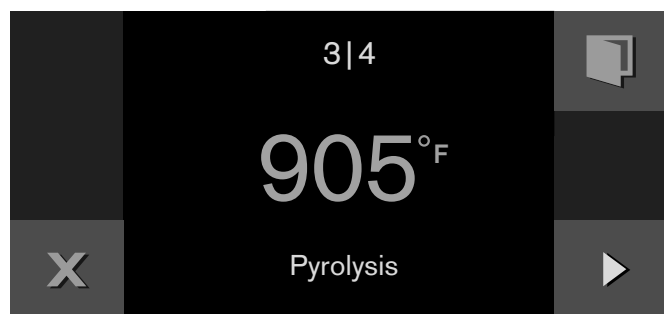

After 3 hours, a signal sounds. A message will appear on the screen. Once the appliance is cool, wipe out the remaining ash from the oven with a damp cloth.

Note: The oven door is locked for your safety. After cooling down, the door is unlocked as soon as the temperature has dropped below 390 °F (200 °C).

Cleaning the Accessories with the Pyrolytic Self-cleaning Feature

Gaggenau baking trays and broiler pans are coated with pyrolysis-resistant enamel. For optimal results when cleaning the oven, we recommend removing all accessories from the oven before initiating the pyrolytic self-cleaning feature. This is the only way to achieve even heat distribution.

If you wish to remove burnt-on residue from your baking tray or broiler pan with the pyrolytic self-cleaning cycle, please observe the following instructions:

Notes

- Remove the worst soiling, meat juices, and food residues before initiating the pyrolytic self-cleaning cycle. Food residues, grease, and meat juices may catch fire during the pyrolytic self-cleaning cycle.
- Slide only one baking tray or broiler pan onto the lowest rack in the oven.
- Push the baking tray or broiler pan in as far as it will go.
- Wire rack, rotisserie spit, cast iron roaster, baking stone, core temperature sensor, or other accessories must not be cleaned in the pyrolytic self-cleaning cycle.
- Broiler pans with stainless steel bushings can discolor during the pyrolytic self-cleaning cycle. This does not affect its usability.



Troubleshooting

You can often easily eliminate problems that may occur on your own. Before calling customer service, take into account the following information.

WARNING

Risk of electric shock

Improper repairs are dangerous. Only an authorized servicer may perform repairs and may replace damaged plug and connections. Remove the power plug or turn off the circuit breaker or fuse in the fuse box if the appliance is damaged or not working. Call Customer Service.

Disruption	Possible cause	Solution
Appliance not working, no display	Plug not inserted	Connect the appliance to the electricity mains
	Power failure	Check whether other kitchen appliances are working
	Fuse defective	Check in the fuse box whether the fuse for the appliance is in working order
	Operating error	Switch off the fuse for the appliance in the fuse box and switch it on again after about 10 seconds
Appliance cannot be started	Appliance door is not quite closed	Close appliance door
Appliance is not working, display is not responding.  appears in the display.	Child lock activated	Deactivate child lock (see section entitled 'Child lock')
Appliance switches off automatically	Safety deactivation: the appliance has not been operated for longer than 12 hours	Confirm the message with  , switch off the appliance and set it again.
Appliance does not heat up,  appears in the display	Appliance is in the demo mode	Deactivate demo mode in the basic settings
Error message "Exxx"		If an error message appears, turn the program selection to 0; if the display goes off, it was a one-time problem. If the problem occurs repeatedly or if the display stops, please contact after-sales service and inform them of the error code.

Power cut

Your appliance can bridge a power cut of a few seconds. Operation continues.

If the power cut was for a longer period and the appliance was in operation, a message appears in the display. Operation is interrupted.

Set the function selector to 0, then the appliance can be operated again as usual.

Demo mode

The demo mode is activated if the  symbol appears in the display. The appliance does not heat up.

Briefly disconnect the appliance from the mains (switch off the domestic fuse or the circuit-breaker in the fuse box). Then deactivate the demo mode within 3 minutes in the factory setting (see section entitled 'Factory setting').

Replacing the oven lamp

You can replace the oven lamps. You can obtain replacement lamps after-sales service or from trade dealers. Use the same type of halogen bulbs only.

- Top lamp:
60 W/230 V/G9
- Side lamp: 10 W/12 V/G4

WARNING

Risk of electric shock

When you replace the oven interior lamp, the contacts of the lamp holder are live. Before replacing the lamp, remove the power plug or deactivate the circuit breaker or fuse in the fuse box.

WARNING

Risk of burns

Lamps become very hot when switched on. There is still a risk of burning your skin for some time after they have been switched off. Allow lamps to cool down before replacing them.

Note: Always use a dry cloth to remove the halogen lamp from its packaging. This lengthens the lamp's useful life.

Replacing the top oven lamp

- 1 Undo the screw on the lamp cover. The lamp cover folds down.
- 2 Take out the halogen lamp. Insert the new halogen lamp.
- 3 Fold up and screw down the lamp cover.
- 4 Switch on the fuse in the fuse box again.

Replacing the side oven lamp

- 1 Place a dishcloth in the oven to avoid damage.
- 2 Undo the knurled screws on the slide-in rack. Remove the slide-in rack.
- 3 Press the top retaining spring to the side. Remove the glass cover.
- 4 Take out the halogen lamp. Insert the new halogen lamp.
- 5 Insert the glass cover at the bottom into the retaining spring and latch it at the top. The beveled side of the glass cover must point toward the oven.
- 6 Remove the dishcloth from the oven.
- 7 Switch on the fuse in the fuse box again.

Replacing the glass cover

The glass cover in the oven must be replaced if it is damaged. You can obtain covers from after-sales service. Always specify the E number and the FD number of your appliance.

Customer service

If your appliance needs repairs, our customer service is there for you. We work hard to help solve problems quickly and without unnecessary service calls, getting your appliance back up and running correctly in the least amount of time possible.

When you call, please indicate the product number (E-Nr.) and serial number (FD-Nr.) so that we can support you in a qualified manner. You will find the type plate with these numbers on the bottom of the appliance. To avoid having to search for a long time when you need it, you can enter your appliance data and the customer support telephone number here.

E-Nr.

FD-Nr.

Customer Service ☎

Please read the use and care instructions provided with your appliance. Failure to do so may result in an error in using the appliance. This could result in a service call that instead of fixing a mechanical issue is only needed for customer education. Such calls are not covered by the appliance warranty.

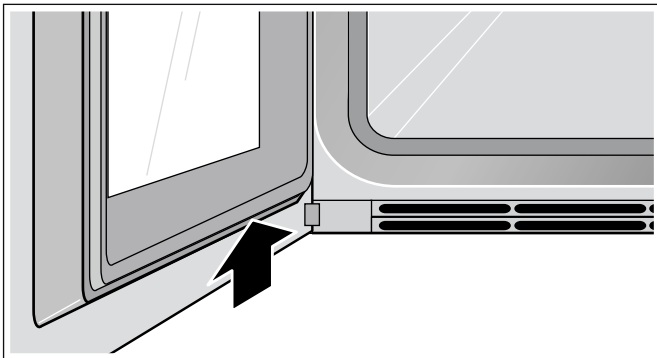

Please find the contact data of all countries in the enclosed customer service list.

To book an engineer visit and product advice

USA 877 442 4436
 toll-free

CANADA 877 442 4436
 toll-free

You can rely on the manufacturer's expertise. Rest assured that the repair will be handled by trained service technicians who have the original replacement parts for your appliance.

Tables and tips

Notes

- Always preheat the appliance. This will provide the best cooking results. The cooking times specified refer to a pre-heated appliance.
- The values specified are intended as a guide. The actual cooking time depends on the quality and temperature of the food before cooking, the weight and thickness of the food to be cooked.
- The tables list temperature and/or time ranges. Try the lowest value to start with. You can always choose a longer time next time if need be. A lower temperature will result in more even browning. If necessary, set a higher temperature.
- The specifications refer to average quantities for four people. If you would like to prepare more, you should calculate a longer cooking time.
- Use the cookware specified. If you use other cookware, cooking times may be longer or shorter.
- You may use any heat-resistant cookware. Place the cookware in the center of the wire rack. For large roasts, you can also use the grill or glass tray.
- Do not crowd the wire rack and baking trays too tightly. This guarantees optimal heat circulation.
- For the preparation of bulky foods, you can also remove the side slide-in tray. Place the wire rack directly on the bottom of the cooking compartment and place the food or the roasting dishes on the wire rack. Do not place the food or the roasting dishes directly on the enameled bottom.
- Make sure to open the cooking compartment door of the pre-heated appliance only briefly and to fill the cooking compartment quickly.
- The details for the level refer to the slide-in level from below for appliances with 4 slide-in levels. The values in brackets refer to appliances with 5 slide-in levels.
- When removing it, place glass cookware on a dry trivet, never on a cold or wet surface. The glass can explode.
- Some operating modes are not available with all oven models or only with special accessories.
- Economy heating function:
Energy-saving hot air operation for cakes, meat, bakes and gratins. Optimal use is made of the residual heat. Convenience functions remain switched off (e.g. the interior lighting). The cooking compartment temperature can only be displayed while the appliance is heating up. Do not preheat the oven.
Make sure that the cooking compartment is cold and that there is nothing already in there when you place the food inside. Then start the specified cooking time. To avoid losing heat, always keep the appliance door closed when cooking.

Vegetables

- Vegetables from the oven are a good alternative to vegetables from the pan. The flavors are concentrated and the roasting aromas make them very aromatic. Furthermore, very little fat is required for preparation.
- Wash the vegetables and mix them in a bowl with a little oil. Place in a heat-resistant pan or distribute evenly in the glass/grill tray.
- During cooking, stir at least once. After cooking, adjust the spices and flavor to taste with fresh herbs.
- Vegetables are suitable as warm or cold appetizers or vegetarian main dishes, or also as side dishes to be served with fish and meat.
- For small portions (for 2-3 people), use an ovenproof dish and place it on the wire rack. Otherwise the food will burn or dry out in the glass/wire tray.
- Always follow the manufacturer's instructions for pre-cooked and frozen products.

Dish	Accessories	Level	Temperature in °F (°C)	Type of heating	Cooking time in min.	Observations
Vegetable skewers	Wire rack + Grill tray	3 (4)	430 (220)	~~~~~	24*	Cut wooden skewers short or soak in water overnight so they do not burn. Recipe tip: peppers, onions, corn (pre-cooked), cherry tomatoes, zucchini
Green asparagus grilled	Glass/grill tray	3 (4)	570 (300)	~~~~~	6 - 10*	Recipe tip: season with onions, oil, vinegar, salt, and pepper.
Root vegetables	Glass/grill tray	3 (4)	390 (200)	✿	30*	Recipe tip: carrots, celery, rutabagas, red beets with oil, season with oil, garlic, salt, and pepper.
		3 (4)	480 (250)	~~~~~	15 - 20*	
Pumpkin pieces	Glass/grill tray	3 (4)	390 (200)	✿	30*	Recipe tip: season with oil, garlic, ginger, cumin, salt, and pepper.
Antipasti	Glass/grill tray	3 (4)	390 (200)	✿	30*	Recipe tip: as long as the vegetables are still hot, drizzle with balsamic vinegar and season.
		3 (4)	480 (250)	~~~~~	15 - 20*	
Escalivada (Mediterranean oven-roasted vegetables)	Ovenproof dish	4 (5)	480 (250)	~~~~~	15*	Recipe tip: eggplant, onions, tomatoes, peppers, oil. Tastes good warm and cold.
Ratatouille	Glass/grill tray	3 (4)	390 (200)	--- ---	30 - 40*	Recipe tip: sprinkle with Parmesan at the end.
Baked tomatoes	Ovenproof dish	2 (3)	250 (120)	✿	60	Recipe tip: place cherry tomatoes or tomato slices, rosemary, and garlic in the pan and drizzle with oil and a little honey. If desired, blanch and peel tomatoes beforehand.
Chicory	Ovenproof dish	2 (3)	355 (180)	✿	25 - 30	Recipe tip: Halve, season, wrap in cooked ham, top with cream or Béchamel sauce, and sprinkle with cheese.
		2 (3)	375 (190)	✿ ^e	40 - 45	No need to preheat; do not open appliance door.
Stuffed peppers, vegetarian	Ovenproof dish/roasting dish	2 (3)	390 (200)	--- ---	30 - 34	Recipe tip: fill with cooked rice, Eibly wheat or lentils and onions, cheese, herbs and spices.
Stuffed zucchini, vegetarian	Glass/grill tray	2 (3)	355 (180)	✿	25	Recipe tip: fill with grated carrots, spring onions, fresh goat cheese, garlic, thyme, salt and pepper and sprinkle with Parmesan.

* Turn food halfway through the cooking time.

Dish	Accessories	Level	Temperature in °F (°C)	Type of heating	Cooking time in min.	Observations
Vegetable bake	Ovenproof dish	2 (3)	390 (200)	---	20 - 30	Pre-cook/blanch vegetables and other ingredients.
Veggie burgers, frozen	Baking tray + greaseproof paper	2 (3)	430 (220)	✿	12 - 15*	

* Turn food halfway through the cooking time.

Side dishes and dishes

- The best side dishes from the oven are based on potatoes, for example potatoes au gratin. However, other outstanding side dishes can also be prepared in the oven, which normally are prepared in the pan (e.g. potato pancakes or fried potatoes). The advantages of this type of preparation: you can prepare larger quantities at once, the cooking smells are distributed less in the room, and you can prepare the dishes with less fat.
- Another versatile side dish from the oven is cheese. Cheese is an especially good addition to vegetarian dishes, or you can prepare the cheese as an appetizer or finger food.
- Dishes that are suited for preparation in the oven are especially dishes that are gratinated, such as casseroles and gratins. Suitable also are dishes with a dough base, e.g. pizza or tarte flambée, and egg dishes such as tortillas.
- For small portions (for 2-3 people), use an ovenproof dish and place it on the wire rack. Otherwise the food will burn or dry out in the glass/wire tray.
- Always follow the manufacturer's instructions for pre-cooked and frozen products.

Dish	Accessories	Level	Temperature in °F (°C)	Type of heating	Cooking time in min.	Observations
Side dishes						
Salted potatoes	Ovenproof dish	2 (3)	390 (200)	---	40 - 60*	Fill ovenproof dish with 2 cm sea salt. Place small, unpeeled potatoes on top, brush with olive oil.
Potato wedges	Baking tray + Greaseproof paper	2 (3)	390 (200)	✿	15*	Recipe tip: cut potatoes in wedge, season with olive oil, paprika, and salt.
French fries, fresh	Baking tray + Greaseproof paper	3 (4)	390 (200)	✿	15 - 20*	Recipe tip: oil slightly, after cooking, season with salt, paprika or curry powder.
French fries, frozen	Baking tray + Greaseproof paper	3 (4)	430 (220)	✿	14*	
Potato gratin	Ovenproof dish	2 (3)	355 (180)	✿	35	No need to preheat; do not open appliance door.
		2 (3)	375 (190)	✿ ^e	50	
Potato pancakes	Baking sheet	2 (3)	345 (175)	✿	20 - 30*	Oil baking tray thoroughly, press down the potato pancake batter, brush with oil. Turn once.
		2 (3)	390 (200)	---	20 - 30*	
Roasted potatoes	Grill tray	2 (3)	355 (180)	✿	30 - 45*	Low-fat preparation. Distribute evenly on the grill tray, mix several times.
Goat cheese wrapped in bacon	Glass tray/baking tray	2 (3)	430 (220)	✿	8 - 10	Fresh goat cheese or goat camembert works well.
		3 (4)	430 (220)	~~~~~	8 - 10	
Goat cheese with honey	Glass tray/baking tray	2 (3)	390 (200)	✿	8	Recipe tip: drizzle fresh goat cheese or goat camembert with lavender honey and sprinkle with pine nuts.
		3 (4)	390 (200)	~~~~~	8	

* Turn food halfway through the cooking time.

Dish	Accessories	Level	Temperature in °F (°C)	Type of heating	Cooking time in min.	Observations
Baked camembert, breaded, fresh	Baking tray + greaseproof paper	2 (3)	355 (180)	☼	15 - 20	Bake until the breading puffs out.
Baked camembert, breaded, frozen	Baking tray + greaseproof paper	2 (3) 2 (3)	355 (180) 390 (200)	☼ ---	15 - 20 15	Bake until the breading puffs out.
Mozzarella sticks, frozen	Baking tray + greaseproof paper	2 (3)	355 (180)	☼	10	
Feta	Baking sheet	2 (3)	480 (250)	☼ ☼	12	Recipe tip: put in a pan with oil, tomatoes, onions, garlic, and rosemary and season with salt and pepper.
Grilled cheese, fresh	Baking sheet	2 (3)	355 (180)	☼	20	After 10 min., cut the cheese in the shape of a cross and fold open. If possible, the pan should not be much larger than the cheese so that it does not run out.
Dishes						
Tortillas	Ovenproof dish	2 (3)	320 (160)	☼	40	Recipe tip: with pepper, olives, onions, Serrano ham, and Manchego cheese.
Farmers' omelette	Ovenproof dish	2 (3)	320 (160)	☼	40	Recipe tip: with green and white asparagus, serve with gravled lox.
Frittata	Ovenproof dish	2 (3)	375 (190)	---	45 - 50	Recipe tip: with spinach, onions, and prawns.
Enchiladas, au gratin	Glass/ grill tray	2 (3)	390 (200)	---	15 - 20	
Lasagne	Ovenproof dish	2 (3)	345 (175)	☼	35	Recipe tip: classic or vegetarian with grilled vegetables and Buffalo mozzarella.
		2 (3)	355 (180)	☼ ^e	50 - 60	No need to preheat; do not open appliance door.
Macaroni and cheese	Ovenproof dish	2 (3)	355 / 430 (180 / 220)	☼	10 - 20	For a cheesy crust, increase the temperature to 430°F (220°C) after 10 min. and let brown for 10 min.
Cheese spätzle	Ovenproof dish	2 (3)	355 / 430 (180 / 220)	☼	30	Gradually layer freshly-cooked spätzle into the pan, sprinkle each layer with cheese. Finally, top with cheese and roasted onions and increase the temperature to 430°F (220°C) for 5 min.
Spring rolls, frozen	Baking tray + Greaseproof paper	2 (3)	435 (225)	☼	18 - 20*	
Mini spring rolls, frozen	Baking tray + Greaseproof paper	2 (3)	435 (225)	☼	10*	
Pizza, fresh	Baking sheet	2 (3)	445 - 480 (230 - 250)	---	10 - 15	Oil baking tray slightly.
Pizza, pre-baked	Baking tray + Greaseproof paper	2 (3)	445 (230)	☼	6 - 8	
		2 (3)	445 (230)	---	6 - 8	
Pizza, frozen	Wire rack	2 (3)	390 (200)	☼	11 - 13	
		2 (3)	430 (220)	---	11 - 13	

* Turn food halfway through the cooking time.

Dish	Accessories	Level	Temperature in °F (°C)	Type of heating	Cooking time in min.	Observations
American Pizza (thick dough), frozen	Baking sheet	2 (3)	390 (200)	---	20 - 24	Do not preheat!
Tarte flambee, fresh	Baking sheet	2 (3)	480 (250)	---	8 - 10	Recipe tip: classic or with fresh goat cheese, Parma ham, figs, and pring onions.
Tarte flambee, pre-baked	Baking tray + Greaseproof paper	2 (3)	480 (250)	✿	7	
Tarte flambee, frozen	Wire rack	2 (3)	390 (200)	✿	10 - 12	
		2 (3)	445 (230)	---	8 - 10	
Quiche	Pie dish	2 (3)	390 (200)	---	20 + 20	Pre-bake crust for 20 min., pour mixture into the crust, and bake another 20 min.
Onion tart	Baking sheet	2 (3)	390 (200)	---	30 - 40	
* Turn food halfway through the cooking time.						

Fish

- Fish should (for hygienic reasons) have a core temperature of at least 144 - 158°F (62 - 70 °C) after cooking. This is also the ideal cooking point.
- Only salt the fish after cooking. Thus the natural aroma is retained and less water is removed from the fish.
- Oil the wire rack and baking tray a little bit, then the fish will not stick.
- For fillets with skin: if you place the fish skin-side up, the structure and aroma will be retained better.
- Cut wooden skewers short or soak in water overnight before skewering the ingredients so they do not burn.
- Always follow the manufacturer's instructions for pre-cooked and frozen products.

Dish	Accessories	Level	Temperature in °F (°C)	Type of heating	Cookingtime in min.	Observations
Shrimp skewers, fresh	Wire rack + Grill tray	3 (4)	355 (180)	~~~~~	10*	
Shrimp skewers, frozen	Wire rack + Grill tray	3 (4)	355 (180)	~~~~~	12*	
Fish kebabs	Wire rack + Grill tray	3 (4)	390 (200)	~~~~~	12*	Use firm types of fish, e.g. salmon, ocean perch, cod.
Trout, whole	Baking sheet	3 (4)	390 - 430 (200 - 220)	~~~~~	16*	Recipe tip: fill with lemon, garlic, and parsley.
Sea bream, whole	Wire rack + Grill tray	3 (4)	390 - 430 (200 - 220)	~~~~~	20 - 25*	Recipe tip: fill with lemon, garlic, and thyme or make it summery with mint. Cut into the skin of the sea bream diagonally.
	Baking sheet	3 (4)	345 (175)	✿	20 - 25*	
Salmon steak	Wire rack + Grill tray	3 (4)	480 (250)	~~~~~ ☼	10 - 12	Recipe tip: marinate with lime, salt, pepper, and garlic.
	Baking sheet	2 (3)	390 (200)	✿	10 - 12	
Tuna steak	Baking sheet	3 (4)	480 (250)	~~~~~ ☼	8 - 10	Recipe tip: season Asian style with soy sauce, sesame oil, ginger, honey, garlic, chili, and coriander seeds.
Fish sticks, frozen	Baking tray + greaseproof paper	2 (3)	430 (220)	✿	15 - 17*	
Squid rings, frozen	Baking tray + greaseproof paper	2 (3)	430 (220)	---	8 - 12	

* Turn food halfway through the cooking time.

Meat



















- For better results, use the core temperature sensor. For notes and optimal target temperatures, see the **Core temperature sensor** chapter.
- Let meat rest 10 - 15 min. after cooking. This way, the meat can "relax." The circulation of the meat juice slows down and there is less loss of juice when cutting into the meat. Large pieces of meat such as roasts can rest in the oven. Smaller ones, e.g. steaks, should rest outside the oven wrapped in aluminum foil.
- For small portions (2 - 3 people) use a heat-resistant pan so that the food does not burn or dry out.
- Use the wire rack or the roasting dish for a large roast and for types of preparation that generate a lot of liquid for roasting.
- Marinate overnight and discard the marinade before roasting or grilling, e.g. with the back of a knife or a spoon. Otherwise the spices and herbs will burn.
- When the roast gets too dark and the crust is burned in places, reduce the temperature the next time and check the slide-in level.
- If the roast is cooked but the sauce is burned on, next time use a smaller roasting dish and add more liquid. If the sauce is too watery, next time use a larger roasting dish and add less liquid.

Dish	Accessories	Level	Temperature in °F (°C)	Type of heating	Cooking time in min.	Observations
Beef						
Roast beef (1.5 kg)	Glass/grill tray	2 (3)	355 (180)	✚	90 - 120*	
Rump steak, medium rare, 15.9 oz (450 g)	Glass/grill tray	2 (3)	390 (200)	✚	30	Core temperature 150° F (65 °C)
		2 (3)	390 (200)	✚ ^e	40	Core temperature 150° F (65 °C). No need to preheat; do not open appliance door.
Roast beef/sirloin (1 kg) - rare	Glass/grill tray	2 (3)	445 / 355 (230 / 180)	✚	25 - 35**	Recipe tip: tastes very good with Béarnaise sauce or sliced cold with remoulade and roasted potatoes.
- medium	Glass/grill tray	2 (3)	445 / 355 (230 / 180)	✚	30 - 40**	
- well-done	Glass/grill tray	2 (3)	445 / 355 (230 / 180)	✚	50 - 60**	
Pork						
Fillet of pork, whole	Glass/grill tray	2 (3)	445 / 355 (230 / 180)	✚	20 - 25**	Recipe tip: marinate with oil, garlic, and parsley.
Fillet of pork, 0.6 lb (260 g)	Glass/grill tray	2 (3)	355 (180)	✚	30	Core temperature 160° F (70 °C).
		2 (3)	355 (180)	✚ ^e	40	Core temperature 160° F (70 °C). No need to preheat; do not open appliance door.
Pork medallions	Glass/grill tray	2 (3)	355 (180)	✚	12 - 15*	Recipe tip: shortly before removing, put a piece of butter and a rosemary sprig in the glass/grill tray and continue cooking in the oven.
Pork roast - joint (1 kg)	Glass/grill tray	2 (3)	445 / 355 (230 / 180)	✚	45 - 50**	
Pork roast - neck (1.5 kg)	Glass/grill tray	2 (3)	445 / 355 (230 / 180)	✚	85 - 95**	
		2 (3)	445 / 355 (230 / 180)	✚ ^e	70 - 80**	
Pork roast with crust (1.5 kg)	Wire rack + Grill tray	2 (3)	355 / 390 (180 / 200)	✚ ^e	60 - 70***	

* First cook thoroughly in a pan/roasting dish on the burner.

** Brown the meat at high temperature, after 15 - 20 min. switch back to a lower temperature.

*** Cook meat at a low temperature, set the temperature higher for the last 15 - 20 min.

Dish	Accessories	Level	Temperature in °F (°C)	Type of heating	Cooking time in min.	Observations
Pork knuckles	Wire rack + Grill tray	2 (3)	300 / 390 (150 / 200)		40 - 45***	Cut roughly into skin so that it gets crusty.
Smoke-cured pork (1 kg)	Glass/grill tray	2 (3)	355 / 320 (180 / 160)		50 - 60**	
Rolled pork	Glass/grill tray	2 (3)	445 / 355 (230 / 180)		65 - 70***	
	Wire rack + Grill tray	2 (3)	445 / 355 (230 / 180)		75 - 80***	
Veal						
Veal roast (1.5 kg)	Glass/grill tray, roasting dish	2 (3)	355 (180)		50 - 60*	
Veal knuckle	Glass/grill tray, roasting dish	2 (3)	300 / 355 (150 / 180)		50 - 60***	
Veal loin	Glass/grill tray, roasting dish	2 (3)	320 - 340 (160 - 170)		20	
Stuffed breast of veal	Glass/grill tray, roasting dish	2 (3)	250 - 265 (120 - 130)		120	
Game						
Wild boar roast	Glass/grill tray, roasting dish	2 (3)	340 (170)		60 - 90*	Recipe tip: marinate overnight in oil, garlic, mustard, and herbes de Provence.
Leg of venison	Glass/grill tray, roasting dish	2 (3)	340 - 355 (170 - 180)		60 - 80	
Saddle of venison	Glass/grill tray, roasting dish	2 (3)	330 - 345 (165 - 175)		20	
		2 (3)	330 - 345 (165 - 175)		20 - 25	
Saddle of hare or rabbit	Glass/grill tray, roasting dish	2 (3)	355 (180)		15 - 25*	Recipe tip: marinate in garlic, rosemary, olive oil, and high-quality balsamic vinegar.
Leg of lamb - medium	Glass/grill tray, roasting dish	2 (3)	355 - 375 (180 - 190)		100*	Recipe tip: marinate overnight in olive oil, garlic, rosemary, and lemon peel.
					120*	
Knuckle of lamb	Glass/grill tray, roasting dish	2 (3)	355 - 390 (180 - 200)		35 - 45	
Miscellaneous						
Meatballs (80 g each)	Baking tray + greaseproof paper	2 (3)	390 (200)		30 - 35	The flatter the meatballs are, the quicker they will cook. Well-suited for large quantities.
Meatballs, cooked (80 g each)	Baking tray + greaseproof paper	2 (3)	390 (200)		20	Well-browned and yet juicy meatballs: first cook in the pan and then put in the oven.
Meatballs (25 g each)	Baking tray + Greaseproof paper	2 (3)	390 (200)		25 - 30	Recipe tip: very good for further combinations, e.g. meatballs with tomato sauce, Swedish meatballs, Königsberger meatballs.

* First cook thoroughly in a pan/roasting dish on the burner.

** Brown the meat at high temperature, after 15 - 20 min. switch back to a lower temperature.

*** Cook meat at a low temperature, set the temperature higher for the last 15 - 20 min.

Dish	Accessories	Level	Temperature in °F (°C)	Type of heating	Cooking time in min.	Observations
Meatballs, cooked (25 g each)	Baking tray + Greaseproof paper	2 (3)	390 (200)	✚	15	Recipe tip: put meatballs of lamb or rabbit on a skewer and serve with minted yogurt or fig mustard.
Head cheese, fresh (700 g)	Wire rack + Grill tray	2 (3)	320 (160)	✚	60	Use core temperature sensor (core temperature 153°F (67 °C)).
Bacon strips, thin	Baking tray + Greaseproof paper	3 (4)	355 (180)	✚	8 - 10	After taking out, let drip on a paper towel.
Bacon strips, thick	Baking tray + Greaseproof paper	3 (4)	375 (190)	✚	8 - 12	
Stuffed peppers with ground meat	Ovenproof dish/roasting dish	2 (3)	345 (175)	✚	55 - 60	Recipe tip: fill with ground meat and cook in tomato sauce.

* First cook thoroughly in a pan/roasting dish on the burner.

** Brown the meat at high temperature, after 15 - 20 min. switch back to a lower temperature.

*** Cook meat at a low temperature, set the temperature higher for the last 15 - 20 min.

Poultry

- For better results, use the core temperature sensor. Do not place it in the middle (hollow space), but rather between the belly and upper thigh. For notes and optimal target temperatures, see the **Core temperature sensor** chapter.
- Poultry will turn out particularly crispy and brown if you baste it towards the end of the roasting time with butter, salted water, drippings or orange juice.
- When cooking duck or goose, pierce the skin on the underside of the wings to allow the fat to run out.
- Use a roasting dish or another heat-resistant pan for dishes that generate a lot of liquid for roasting. The same applies if a lot of fat can run out of the food, e.g. with roast goose.















Dish	Accessories	Level	Temperature in °F (°C)	Type of heating	Cooking time in min.	Observations
Duck, whole (1.5 - 2 kg)	Wire rack + Grill tray/roasting dish	2 (3)	320 / 355 (160 / 180)	---	75*	Recipe tip: fill with oranges, apples or dried fruit.
Duck breast	Roasting dish/oven-proof dish	2 (3)	320 (160)	✿	25 - 35	Tear skin roughly.
Goose, whole (5 kg)	Wire rack + Grill tray/roasting dish	2 (3)	320 / 375 (160 / 190)	✿	110 - 130*	Recipe tip: fill with apples, onions, and marjoram and pierce.
		2 (3)	320 / 375 (160 / 190)	---	110 - 130*	
Turkey hen, whole	Wire rack + Grill tray/roasting dish	2 (3)	320 / 375 (160 / 190)	✿	120 - 180*	
		2 (3)	320 / 375 (160 / 190)	---	120 - 180*	
Chicken, whole (according to EN 60350-1)	Wire rack + Grill tray	2 (3)	375 (190)	✿	70 - 80	Preheat
		2 (3)	375 (190)	☼	70 - 80	
Chicken, legs and thighs	Wire rack + Grill tray	3 (4)	430 (220)	~~~~~	30**	Recipe tip: Asian marinade with soy sauce, honey, chili, garlic, ginger, cumin, lime rub, coriander.
		3 (4)	430 (220)	☼	30**	
Chicken legs	Wire rack + Grill tray	3 (4)	430 (220)	~~~~~	30**	After turning, the side with more skin should be up; this way, it gets crispy. Marinate with oil, rosemary, lime wedges, and garlic.
		3 (4)	430 (220)	☼	30**	
Chicken breast	Wire rack + Grill tray	2 (3)	390 (200)	✿	25	Recipe tip: before cooking, rub with Tandoori paste.
		2 (3)	390 (200)	✿ ^e	45	No need to preheat; do not open appliance door.
Chicken nuggets, frozen	Baking tray + Greaseproof paper	2 (3)	390 (200)	✿	15**	
Breast of quail	Baking sheet	3 (4)	430 (220)	☼	10 - 12	Baste with oil and spices, e.g. paprika, thyme, juniper, and garlic.
Quail, whole (150 g each)	Wire rack + Grill tray	3 (4)	390 (200)	☼	20 - 25	Baste with oil and spices, e.g. paprika, thyme, juniper, garlic.

* Cook meat at a low temperature, set the temperature higher for the last 15 - 20 min.

** Turn food halfway through the cooking time.

Grilling and roasting

- Do not grill food with the oven door open.
- Use the grill tray with inlaid shelf for grilling (depending on the version, accessory or special accessory). Pour approximately 100 ml water into the grill tray; this will catch the meat juices so that the oven stays clean. If you pour in too much water, this may alter the cooking result because too much steam will be produced.
- The pieces of food to be grilled should be of roughly the same thickness (at least 2 to 3 cm). This will allow them to brown evenly and remain succulent and juicy. Never add salt to meat before grilling it. Place the pieces to be grilled directly on the wire rack.
- If you use wooden skewers, these can burn. In order to prevent this, cut the skewers as short as possible or soak them overnight in water before spearing the ingredients, or use metal skewers.
- For small quantities, use the energy-saving "Compact grill" heating function. With this heating function, only the center part of the grill is heated. Place the food to be grilled in the middle of the wire rack.

Dish	Accessories	Level	Temperature in °F (°C)	Type of heating	Cooking time in min.	Observations
Pork belly, sliced	Wire rack + Grill tray	3 (4)	530 (275)		18 - 20*	
		3 (4)	480 (250)		18 - 20*	
Shish kebab	Wire rack + Grill tray	3 (4)	375 (190)		16*	
Bratwurst	Wire rack + Grill tray	3 (4)	520 (270)		10*	
Merguez (grilling sausage)	Wire rack + Grill tray	3 (4)	480 (250)		12*	
Spare ribs, pre-cooked	Wire rack + Grill tray	3 (4)	390 - 430 (200 - 220)		24*	
		3 (4)	390 - 430 (200 - 220)		24*	
Spare ribs, raw	Wire rack + Grill tray	3 (4)	430 (220)		40*	Recipe tip: put in oil, mustard, balsamic vinegar, honey, garlic, Worcester sauce, tomato paste, and Tabasco.
		3 (4)	430 (220)		30*	
Chicken Satay	Wire rack + Grill tray	3 (4)	480 (250)		10 - 14*	Serve with peanut sauce.
Halloumi cheese (grilled cheese)	Wire rack + Grill tray	3 (4)	480 (250)		5 - 8	Halloumi is a firm cheese that is used in Turkish and Greek cuisine. It is very well-suited for grilling.
Toasting open-faced sandwiches	Wire rack	3 (4)	390 (200)		1 - 2*	Remain near the appliance so that the sandwiches do not burn.
Toast Hawaii	Baking tray + greaseproof paper	3 (4)	375 (190)		8 - 10**	
Croque Monsieur	Baking tray + greaseproof paper	3 (4)	375 (190)		8 - 11**	
Croutons	Baking sheet	2 (3)	355 (180)		15*	Recipe tip: mix fresh white bread with olive oil, garlic, and rosemary needles. Do not use too much oil and pour the oil over only shortly beforehand so that the bread cubes do not get soggy. Turn several times.

* Turn food halfway through the cooking time.

** Gratin depending on desired degree of browning.

Dish	Accessories	Level	Temperature in °F (°C)	Type of heating	Cooking time in min.	Observations
Cooking "au gratin"	Springform cake pan	2 (3)	430 - 480 (220 - 250)	~~~~~	4 - 5**	Remain near the appliance so that the gratin does not burn.
Dried plums wrapped in bacon	Baking tray + greaseproof paper	3 (4)	390 (200)	~~~~~	8 - 10	Also tastes good with dates or apricots.

* Turn food halfway through the cooking time.

** Gratin depending on desired degree of browning.

Baked goods

- We recommend dark pans of metal since these absorb the heat better. Place the pan in the middle of the wire rack.
 - For sheet cakes without greaseproof paper, oil the pan slightly.
 - Small baked items such as cream puffs, cookies or pastries can be baked on two levels, 1+3 or 2+4.
 - If you bake on several levels it is normal that the trays are not done at the same time. Leave the lower trays bake a little longer or put them in the oven earlier the next time.
 - Before cutting, let the baked goods cool on a rack.
 - If the baked goods are too dark on the bottom: insert one level higher, select a lower temperature. If the baked goods are too dark on the top: insert one level lower, select a lower temperature, and extend the baking time a bit.
 - If the cake is too dry, set the temperature a little higher. If the cake is not cooked on the inside, set the temperature a little lower.
- Baking times cannot be shortened by selecting a higher temperature; it is better to select a somewhat lower temperature.
- If the cake collapses: use less liquid or set the temperature 50°F (10 °C) lower. Do not open the oven door too soon.
 - The cake rises only in the middle: grease the edges of the pan.
 - If the cookies are hard to take off the sheet, insert the sheet in the hot oven again and remove the cookies while they are still warm.
 - If the cake does not come out of the pan when you turn it over, use a knife to loosen the cake around the edges. Turn the cake pan upside down again and cover it several times with a cold, wet cloth. Next time, grease the pan well and sprinkle some bread crumbs into it.
 - Always follow the manufacturer's instructions for pre-cooked and frozen products.

Dish	Accessories	Level	Temperature in °F (°C)	Type of heating	Cooking time in min.	Observations
Cake						
Cheesecake	Springform cake pan	1 (2)	320 - 330 (160 - 165)	✻	70 - 75	
		1 (2)	320 - 330 (160 - 165)	---	70 - 75	
		1 (2)	320 - 330 (160 - 165)	✻	85 - 90	
		1 (2)	320 - 330 (160 - 165)	---	80 - 90	
		1 (2)	320 - 330 (160 - 165)	✻	40 - 45	Cheesecake with half quark filling.

* Pre-heat the appliance to the specified temperature. When putting in the food to be cooked, switch back to the second temperature specification.

** Deactivating the quick heat function in the basic settings (see chapter *Basic settings*: Basic settings > Pre-heat time/signal > Pre-heating with signal)

Dish	Accessories	Level	Temperature in °F (°C)	Type of heating	Cooking time in min.	Observations
Sponge cake	Springform cake pan	2 (3)	320 - 340 (160 - 170)	☛	50 - 60	
		2 (3)	320 - 340 (160 - 170)	---	50 - 60	
Loaf cakes	Loaf pan	2 (3)	320 - 340 (160 - 170)	☛	60 - 65	For even browning, place lengthwise in the cooking compartment.
		2 (3)	320 - 340 (160 - 170)	---	55 - 60	
Bundt cake	Bundt cake pan	1 (2)	330 (165)	☛	30	Recipe tip: classic Bundt cake or with bacon and walnuts.
		1 (2)	340 (170)	☛ ^e	50	No need to preheat; do not open appliance door.
Sheet cakes	Baking sheet	2 (3)	330 - 340 (165 - 170)	☛	40 - 45	Oil baking sheet slightly.
		2 (3)	330 - 340 (165 - 170)	---	40 - 50	
Swiss roll	Baking tray + Greaseproof paper	2 (3)	375 (190)	☛	6	Place dough on greaseproof paper sprinkled with sugar, then roll up.
Sponge base	Springform cake pan	2 (3)	330 - 345 (165 - 175)	☛	30 - 35	Line a springform cake pan with greaseproof paper.
Yeast sheet cake	Baking sheet	2 (3)	330 (165)	☛	30 - 35	Recipe tip: top with plums, figs or onions and bacon.
		2 (3)	330 (165)	---	30 - 35	
Fruit cake on a shortcake base	Pie dish	2 (3)	330 (165)	☛	40 - 50	Recipe tip: top with strawberries or with apricots and marzipan.
		2 (3)	340 (170)	---	40 - 50	
		2 (3)	330 (165)	☛	45 - 55	
Tart	Pie dish	2 (3)	330 (165)	☛	30 - 40	French cake with shortcake base, e.g. tarte aux pommes, tarte tatin, tarte au chocolat, tarte au citron.
		2 (3)	340 (170)	---	30 - 40	
		2 (3)	330 (165)	☛	40 - 45	
		2 (3)	340 (170)	---	45 - 50	For light tart types.
Puff pastry strudel	Baking tray + greaseproof paper	2 (3)	390 (200)	☛	20 - 25	Recipe tip: fill with pudding and cherries or apples.
Apple pie (according to EN60350-1)	Springform cake pan ø 20 cm	2 (3)	320** (160**)	☛	85 - 105	Pre-heat
	Springform cake pan ø 20 cm	1 (2)	355** (180**)	---	80 - 95	Pre-heat
Cake base (according to EN60350-1)	Springform cake pan ø 26 cm	2 (3)	320** (160**)	☛	22 - 30	Pre-heat
	Springform cake pan ø 26 cm	2 (3)	320** (160**)	---	20 - 45	Pre-heat

* Pre-heat the appliance to the specified temperature. When putting in the food to be cooked, switch back to the second temperature specification.

** Deactivating the quick heat function in the basic settings (see chapter *Basic settings*: Basic settings > Pre-heat time/signal > Pre-heating with signal)

Dish	Accessories	Level	Temperature in °F (°C)	Type of heating	Cooking time in min.	Observations
Small baked products						
Cream puffs, eclairs	Baking tray + greaseproof paper	2 (3)	355 (180)	☛	35	Recipe tip: fill with vanilla cream, mousse au chocolat, fruit or mocha cream.
		2 (3)	355 (180)	---	40	
		2 (3)	355 (180)	☛	35	
Cookies, Piped cookies	Baking sheet	2 (3)	320 - 340 (160 - 170)	☛	15	
		2 (3)	320 - 340 (160 - 170)	---	18	
Small puff pastry items	Baking tray + Greaseproof paper	2 (3)	390 (200)	☛	15 - 20	
Filled puff pastry items	Baking tray + Greaseproof paper	3 (4)	390 (200)	☛ / ☛ ^e	15	Recipe tip: fill with ham and cheese or apples and raisins.
Puff pastry	Baking tray + Greaseproof paper	3 (4)	390 (200)	☛	15	Recipe tip: with sesame, poppy, sugar topping.
Puff pastry rods	Baking tray + Greaseproof paper	3 (4)	390 (200)	☛	15	Recipe tip: with ham, cheese, nuts.
Puff pastry slices	Baking tray + Greaseproof paper	2 (3)	390 (200)	☛	15 - 20	Recipe tip: with pudding, fruit.
Hippengebäck cookies	Baking tray + Greaseproof paper	2 (3)	285 (140)	☛	8 - 10	Shape before cooling, e.g. into horns or rolls for dessert.
Breadsticks	Baking tray + Greaseproof paper	2 (3)	320 (160)	☛	30	Sprinkle with sea salt, rosemary, curry, sesame or cumin.
Cookies (20 g each)	Baking tray + Greaseproof paper	2 (3)	345 (175)	☛	12 - 14	With chocolate, raisins, nuts or lemon.
Brownies	Baking tray + Greaseproof paper	2 (3)	250 (120)	☛	60	After baking, cut into squares. Typical is that the consistency is still a bit sticky.
		2 (3)	355 (180)	☛ ^e	35	No need to preheat; do not open appliance door.
Muffins	Muffin pan/ paper wrappers	2 (3)	320 (160)	☛	25 - 30	With chocolate, nuts or raisins.
		2 (3)	345 (175)	---	25 - 30	
		2 (3)	320 - 330 (160 - 165)	-	25 - 30	
Small cakes (according to EN60350-1)	Glass tray	2 (3)	300** (150**)	☛ ^e	25 - 40	Pre-heat
	Baking sheet	3 (4)	300** (150**)	☛ ^e	25 - 40	Pre-heat
	Glass tray	1 (2)				Application on two levels
	Glass tray	3 (4)	320** (160**)	---	20 - 30	Pre-heat

* Pre-heat the appliance to the specified temperature. When putting in the food to be cooked, switch back to the second temperature specification.

** Deactivating the quick heat function in the basic settings (see chapter *Basic settings*: Basic settings > Pre-heat time/signal > Pre-heating with signal)

Dish	Accessories	Level	Temperature in °F (°C)	Type of heating	Cooking time in min.	Observations
Piped cookies (according to EN60350-1)	Baking sheet	2 (3)	285** (140**)	☛	30 - 40	Pre-heat
	Baking sheet	3 (4)	285** (140**)	☛	30 - 45	Pre-heat
	Glass tray	1 (2)				Application on two levels
	Baking sheet	2 (3)	320** (160**)	---	15 - 33	Pre-heat
Bread, rolls						
Multi-grain bread	Baking tray + Greaseproof paper	2 (3)	390 / 340 (200 / 170*)	☛	40 - 50	
		2 (3)	390 / 340 (200 / 170*)	---	40 - 50	
		2 (3)	390 / 330* (200 / 165*)	-	45 - 50	
Sourdough bread	Baking sheet	2 (3)	390 / 355* (200 / 180*)	---	50 - 60	
Olive-tomato bread	Baking sheet	2 (3)	390 / 340 (200 / 170*)	---	40 - 50	
Bread, in loaf pan	Loaf pan	2 (3)	345 (175)	---	40 - 45	
Baguettes, pre-baked	Baking tray + Greaseproof paper	2 (3)	430 (220)	---	10 - 12	
Ciabatta, pre-baked	Baking tray + Greaseproof paper	2 (3)	375 (190)	---	12 - 14	
		2 (3)	355 (180)	☛	12 - 14	
Flatbread	Baking tray + Greaseproof paper	2 (3)	390 (200)	☛	15 - 20	Cooking time depends on the size and thickness of the flatbread.
		2 (3)	410 (210)	---	15 - 20	
Focaccia	Baking tray + Greaseproof paper	2 (3)	410 (210)	---	15 - 20	Top with various ingredients, e.g. with herbs, sea salt, olives, sardines, onions, ham, tomatoes or cheese.
Garlic/herb baguette	Baking tray + Greaseproof paper	2 (3)	390 (200)	---	8 - 10	
Puff pastry strudel	Baking tray + Greaseproof paper	2 (3)	390 (200)	☛	20 - 25	Recipe tip: fill with sheep's milk cheese and feta.
Challah	Baking tray + Greaseproof paper	2 (3)	330 (165)	☛	20	No need to preheat; do not open appliance door.
		2 (3)	340 (170)	☛ ^e	30	
Rolls, pre-baked	Baking tray + Greaseproof paper	2 (3)	410 (210)	---	8 - 10	
		2 (3)	390 (200)	☛	8 - 10	
Rolls, frozen	Baking tray + Greaseproof paper	2 (3)	355 (180)	☛	10 - 12	
		2 (3)	390 (200)	---	10 - 12	
Rolls, fresh (50 g each)	Baking tray + Greaseproof paper	2 (3)	480 / 390* (250 / 200*)	---	15 - 20	

* Pre-heat the appliance to the specified temperature. When putting in the food to be cooked, switch back to the second temperature specification.

** Deactivating the quick heat function in the basic settings
(see chapter *Basic settings*: Basic settings > Pre-heat time/signal > Pre-heating with signal)

Dish	Accessories	Level	Temperature in °F (°C)	Type of heating	Cooking time in min.	Observations
Lye pastries, frozen	Baking tray + Greaseproof paper	2 (3)	390 (200)	☛	10 - 12	
Croissants, frozen	Baking tray + Greaseproof paper	2 (3)	340 (170)	---	15 - 25	

* Pre-heat the appliance to the specified temperature. When putting in the food to be cooked, switch back to the second temperature specification.

** Deactivating the quick heat function in the basic settings
(see chapter *Basic settings*: Basic settings > Pre-heat time/signal > Pre-heating with signal)

Dough proving (leaving to rise)

- Place the bowl with the dough on the wire rack. Select the "dough proofing" heating function.
- For large quantities, e.g. bread, set the temperature to 100 - 105°F (38 - 40°C). This way, the dough rises evenly from the middle to the edges.
- For small quantities of dough, for noodles or rolls, you can set the temperature to 105 - 115°F (40 - 45°C).
- The suggested cooking time is only a guideline. Let the dough proof until its volume has doubled.
- If the dough does not rise, you have used too little yeast or not kneaded the dough enough.

Dish	Accessories	Level	Temperature in °F (°C)	Type of heating	Cooking time in min.	Observations
Dough	Bowl	2 (3)	100 (38)	☞	25 - 45	e.g. yeast dough, natural fermentation starter, sourdough, dumplings

Desserts

- Oven-cooked desserts are very easy to prepare – you just have to put it in the oven. This preparation method is well-suited for larger quantities, for example if you have guests.
- Oven-cooked desserts are generally eaten warm, and are particularly enjoyable during the cooler months.

Dish	Accessories	Level	Temperature in °F (°C)	Type of heating	Cooking time in min.	Observations
Apple Crumble	Ovenproof dish	2 (3)	390 (200)	☛	35 - 40	Apple casserole with streusel, also tastes very good when made with berries or mirabelles.
		2 (3)	390 (200)	---	25 - 30	For soft types of apples.
		2 (3)	390 (200)	---	25 - 30	For firm types of apples.
Baked apples	Ovenproof dish	2 (3)	375 - 390 (190 - 200)	☛	20 - 30	Recommendation: use cooking apples, e.g. Boskop. These are especially well-suited for cooking and baking. Summer variant: fill with ricotta, lemon, honey, cardamom, vanilla, and pine nuts.
Compote	Glass / grill tray	2 (3)	320 - 355 (160 - 180)	☛	30 - 40	e.g. apricots or assorted berries
		2 (3)	390 (200)	---	30 - 40	Do not add any liquid, stir several times. Season with honey, fresh vanilla or cinnamon.

Dish	Accessories	Level	Temperature in °F (°C)	Type of heating	Cooking time in min.	Observations
Clafouti	Ovenproof dish	2 (3)	375 (190)	✿	30 - 35	French dessert: classic with cherries, also tastes very good when made with berries or mirabelles.
		2 (3)	390 (200)	✿ ^e	45 - 50	No need to preheat; do not open appliance door.
Sweet bake	Ovenproof dish	2 (3)	320 - 355 (160 - 180)	✿	30 - 40	e.g. semolina, quark or rice pudding
Bread pudding, cherry cake	Ovenproof dish	2 (3)	300 (150)	✿	50 - 55	e.g. with cherries or apricots
Crepes with quark filling	Ovenproof dish	2 (3)	355 - 375 (180 - 190)	✿	8 - 10	Austrian specialty: pancakes, filled with quark and raisins, topped with cream and baked.
Meringue	Baking tray + greaseproof paper	2 (3)	210 (100)	✿	150	Spread out as flat as possible so that the mass dries all the way through.

Defrosting

- For this, use the "defrost" heating function.
- The defrost values specified are intended as a guide. The defrost time depends on the size, weight, and shape of the food to be defrosted: freeze your foods flat or separately. This shortens the defrost time.
- Slide the wire rack with the frozen food into the second shelf level (in the third shelf level if there are five shelf levels). Slide the grill tray underneath to catch any excess liquid.
- Remove the food from the packaging before defrosting.
- Only defrost the quantity that you need right away.
- Please consider: defrosted food will not last as long as frozen food and will spoil more quickly than fresh food. Prepare defrosted food immediately and cook it thoroughly.
- After half the defrost time has elapsed, turn the meat or fish. Separate defrosted food in pieces,

e.g. berries or pieces of meat. Fish does not have to defrost all the way; it is sufficient if the surface is soft enough to take up the spices.

- The oven is not suited for defrosting whole chickens and roasts; this takes a long time. It is much faster to defrost such foods in the steam oven.

WARNING

Health risk

When defrosting food from animal sources, you must remove the liquid that escapes during defrosting. It must never come into contact with other food. Bacteria could be transferred. Slide the glass/grill tray under the food. Pour away the excess liquid collected from the meat and poultry. Then clean the sink and rinse with plenty of water. Clean the glass/grill tray in hot soapy water or in the dishwasher.

After defrosting, operate the oven for 15 minutes using Hot air at 355°F (180°C).

Dish	Accessories	Level	Temperature in °F (°C)	Type of heating	Cooking time in min.	Observations
Berries (500 g)	Glass / grill tray	2 (3)	120 - 130 (50 - 55)	* ◊	25 - 30	
Vegetables (500 g)	Glass / grill tray	2 (3)	120 - 130 (50 - 55)	* ◊	30 - 50	The defrosting time depends on the portioning. Small vegetables such as peas and beans defrost faster than blocks of spinach or whole cauliflower.
Chicken legs (200 g each)	Wire rack	2 (3)	120 - 130 (50 - 55)	* ◊	45 - 50*	

* Add balancing time: switch appliance off after the defrost time has elapsed and leave the food in the closed appliance for 10 - 15 minutes so that it defrosts all the way to the center.

Dish	Accessories	Level	Temperature in °F (°C)	Type of heating	Cooking time in min.	Observations
Fish fillet (150 g each)	Wire rack	2 (3)	115 - 120 (45 - 50)	* ◊	45 - 50*	
Prawns	Wire rack	2 (3)	115 - 120 (45 - 50)	* ◊	20 - 25	

* Add balancing time: switch appliance off after the defrost time has elapsed and leave the food in the closed appliance for 10 - 15 minutes so that it defrosts all the way to the center.

Preserving

- If possible, cook food immediately after purchase or harvesting. Longer storage decreases the vitamin content and can cause spoilage.
- Only use fruit and vegetables in good condition.
- The oven is not suited for preserving meat.
- Check and clean the canning jars, rubber rings, clamps, and springs carefully.
- Place the canning jars in a heat-resistant container with water. Make sure that they do not touch. The water level must reach at least three quarters of the way up to the top of the contents of the jars.
- Open the cooking compartment door after the cooking time has elapsed. Do not remove the canning jars from the cooking compartment until they have cooled down completely.
- Store the preserves in a cool, dark and dry place, e.g. in a pantry. Once the jars have been opened, use the contents up quickly and store in the refrigerator.

Dish	Accessories	Level	Temperature in °F (°C)	Type of heating	Cooking time in min.	Observations
Fruit	Wire rack	1 (2)	300 - 320 (150 - 160)	---	35 - 40	in closed canning jars
Vegetables	Wire rack	1 (2)	375 - 390 (190 - 200)	---	60 - 120	in closed canning jars

Disinfecting

- Before canning, the jars should be disinfected in the oven in order to prevent spoilage. Only this way is it possible to store canned goods for a longer time and outside the refrigerator.
- Disinfect empty jars at 212°F (100°C) hot air for at least 20 minutes. The lids and seals for the jars can be disinfected simultaneously in boiling water so that they do not dry out in the dry heat in the oven.

Dish	Accessories	Level	Temperature in °F (°C)	Type of heating	Cooking time in min.	Observations
Disinfecting	Wire rack	2 (3)	212 (100)	✚	20 - 25	Canning jars, baby bottles

Drying

- Drying is a preservation method with which, through the feeding in of dry heat, up to 50% of the liquid in food is removed. At the same time, the flavor becomes more intense.
- The thicker the food is, the longer the drying process takes. Drying is the fastest and most energy-saving method if you want to cut food into slices.
- Place the prepared food on a roasting dish or tray covered with greaseproof paper. During the drying process, turn the food every now and then.
- The duration depends on the thickness of the food and the natural moisture in the food since drying tomatoes takes longer than drying mushrooms.
- If you would like to dry on two levels simultaneously, use levels 1 and 3 (or 2 and 4).

Dish	Accessories	Level	Temperature in °F (°C)	Type of heating	Cooking time in hours	Observations
Sliced mushrooms	Wire rack + greaseproof paper	2 (3)	120 - 140 (50 - 60)	☛	3 - 4	
Apple rings	Wire rack + greaseproof paper	2 (3)	120 - 160 (50 - 70)	☛	5 - 8	
Quartered tomatoes	Wire rack + greaseproof paper	2 (3)	140 - 160 (60 - 70)	☛	7 - 8	Remove the core from the tomatoes; otherwise the drying time is longer.
Herbs	Wire rack + greaseproof paper	2 (3)	120 - 140 (50 - 60)	☛	1½ - 2	e.g. chives, parsley, sage

Baking stone

- You will need a baking stone and heating element – these are optional accessories.
- Whether you are baking crispy pizza or fresh bread, with the baking stone, you will achieve results that are comparable to, or even exceed, those that you would get from a massive stone oven because you are able to precisely control the baking temperature.
- Depending on the size, you can also place several pizzas, rolls or other baked goods on the baking stone at the same time.
- You can bake several pizzas in succession. This may increase the baking time per pizza by approx. 1 - 3 minutes.
- When baking bread, we recommend that you use the core temperature sensor. Wait 10 - 15 minutes after baking has begun before inserting the core temperature sensor into the thickest part of the bread. The sensor measures the internal temperature of the baked goods and switches the oven off when the set core temperature has been reached.
- When dough is baked, it needs to be able to expand without the surface breaking apart. This can be achieved by pricking it several times with a fork or by making a cut with a knife.
- The temperatures and times given in the cooking table are guideline values. Always follow the manufacturer's instructions for pre-cooked and frozen products.

Dish	Accessories	Level	Temperature in °F (°C)	Type of heating	Cooking time in min.	Observations
Rolls, fresh (50 g each)	Baking stone	1	480/390* (250/200*)	☞	15 - 20	
Flatbread	Baking stone	1	410 (210)	☞	15	Cooking time depends on the size and thickness of the flatbread.
Focaccia	Baking stone	1	410 (210)	☞	15	Top with various ingredients, e.g. with herbs, sea salt, olives, sardines, onions, ham, tomatoes or cheese.
Multi-grain bread	Baking stone	1	345 (175)	☞	45	
Sourdough bread	Baking stone	1	480/390* (250/200*)	☞	50 - 60	
Olive-tomato bread	Baking stone	1	345 (175)	☞	45	
Pizza, fresh	Baking stone	1	525 (275)	☞	5 - 8	Cooking time varies depending on the type and thickness of the dough and the toppings.
Pizza, frozen	Baking stone	1	445 (230)	☞	8 - 10	Cooking time varies depending on the thickness of the dough. Observe the manufacturer's instructions.
Tarte flambee, fresh	Baking stone	1	570 (300)	☞	3 - 4	Recipe tip: classic or with fresh goat cheese, Parma ham, figs, and pring onions.
Tarte flambee, frozen	Baking stone	1	480 (250)	☞	4 - 5	

* Pre-heat the appliance to the specified temperature. When putting in the food to be cooked, switch back to the lower temperature.

Roasting dish

- You need the special accessory roasting dish and heating element.
 - In the roasting dish, you can also braise large pieces of meat easily and cook large quantities.
 - You can prepare food well and keep food warm in the oven. Your kitchen will look clean and tidy, the cooktop will not be dirty, and there will be fewer cooking odors because the dish was cooked in the oven.
 - The non-stick coating enables you to roast using very little fat.
- Tip: Instead of adding the fat to the roasting dish, oil the meat. This ensures a direct heat transfer.
 - Cooking liquids reduce down quickly. Make sure there is always sufficient cooking liquid. For a cooking time of 30 minutes, add approx. ½ l liquid.
 - When roasting in a sauce, always ensure the sauce remains runny and add cooking liquid.
 - Please also observe the instructions in the roasting dish instruction manual.

Dish	Accessories	Level	Temperature in °F (°C)	Type of heating	Cooking time in min.	Observations
Chicken breast	Roasting dish	1	390 (200)	<input type="checkbox"/>	Searing + 15 - 20	Before inserting the food, also heat the roasting dish with the roasting function. Then insert the core temperature sensor.
Beef goulash	Roasting dish	1	430/265 - 285* (220/130 - 140*)	<input type="checkbox"/>	Searing + 60 - 120	Sear onions and meat; use the roasting setting for this. Pour in liquid and turn heat down, depending on the type of meat, cook for 60 - 120 minutes.
Ossobuco	Roasting dish	1	430/285* (220/140*)	<input type="checkbox"/>	Searing + 60 - 90	Sear meat and vegetables; use the roasting setting for this. Pour in liquid and turn heat down, cook covered for 60 - 90 minutes. Turn once.
Viennese boiled beef	Roasting dish	1	430/265* (220/130*)	<input type="checkbox"/>	Searing + 210 - 240	Sear halved onions, add vegetables briefly and fill up with liquid. Bring to a boil, season, and add beef. The meat should be completely covered with liquid. Put roasting lid on and continue cooking at 265 °F (130 °C).
Venison ragout	Roasting dish	1	430/265 - 285* (220/130 - 140*)	<input type="checkbox"/>	Searing + 60 - 100	Sear meat and other ingredients; use the roasting setting for this. Pour in liquid and turn heat down, depending on the type of meat and size of the pieces of meat, cook for 60 - 100 minutes.
Roulades	Roasting dish	1	430/250* (220/120*)	<input type="checkbox"/>	Searing + 60 - 90	Sear roulades portion by portion; use the roasting setting for this.
Tortillas	Roasting dish	1	345 (175)	<input type="checkbox"/>	Searing + 10 - 15	Sear all ingredients but for the eggs in the roasting dish, then pour the eggs over the top and continue cooking until the tortilla is firm.
Farmers' omelette	Roasting dish	1	345 (175)	<input type="checkbox"/>	Searing + 10 - 15	Sear all ingredients but for the eggs in the roasting dish, then pour the eggs over the top and continue cooking until the farmers' omelette is firm.
Stuffed peppers, vegetarian	Roasting dish	1	390 (200)	<input type="checkbox"/>	30	Recipe tip: fill with cooked rice, Eibly wheat or lentils and onions, cheese, herbs and spices.
Chili con carne	Roasting dish	1	430/265* (220 / 130*)	<input type="checkbox"/>	Searing + 60 - 90	

** Brown the meat at high temperature, switch back to a lower temperature for further cooking.

Acrylamide in foodstuffs

Which foods are affected?

Acrylamide is mainly produced in grain and potato products that are heated to high temperatures, such as chips, fries, toast, rolls, bread, fine baked goods (cookies, gingerbread, Christmas spice cookies).

Tips for keeping acrylamide to a minimum when preparing food

General	Keep cooking times as short as possible. Cook food until it is golden brown, but not too dark. Large, thick pieces of food contain less acrylamide.
Baking	With hot air at max. 355° F (180 °C).
Cookies	Egg or egg yolk reduces the production of acrylamide. Spread out a single layer evenly on the baking tray.
Oven French fries	Cook at least 400 g at once on a baking tray so that the fries do not dry out.

Gaggenau

BSH Home Appliance Corporation
1901 Main Street, Suite 600
Irvine, CA 92614
+1.877.442.4436
USA
www.gaggenau-usa.com

© 2017 BSH Home Appliances

Gaggenau Hausgeräte GmbH

Carl-Wery-Straße 34
81739 München
GERMANY

GAGGENAU

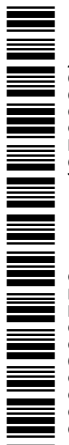

9000866756 en-us (970622)