

**BS 464 610**

**BS 465 610**

Combi-steam oven

---

## Table of Contents

---

<b>Safety Definitions</b>	<b>3</b>
<b>IMPORTANT SAFETY INSTRUCTIONS</b>	<b>4</b>
Proper Installation and Maintenance	4
Fire Safety	4
Burn Prevention	5
Child Safety	6
Cleaning Safety	6
Cookware Safety	7
State of California Proposition 65 Warnings	7
<b>Causes of damage</b>	<b>8</b>
<b>Environmental protection</b>	<b>8</b>
Saving energy	8
<b>Getting to know the appliance</b>	<b>9</b>
Combi-steam oven	9
Displays and controls	10
Symbols	10
Colors and display	10
Additional information <b>i</b> and <b>i</b> <sup>®</sup>	11
Cooling fan	11
Program selection positions	11
Accessories	12
Special accessories	13
<b>Before using the appliance for the first time</b>	<b>13</b>
Setting the language	14
Setting the time format	14
Setting the time	14
Setting the date format	14
Setting the date	14
Setting the temperature format	15
Setting water hardness	15
Completing initial set-up	15
Calibrating	15
Grease filter	16
Cleaning accessories	16
<b>Activating the appliance</b>	<b>17</b>
Standby	17
Activate appliance	17
<b>Operating the appliance</b>	<b>17</b>
Filling the water tank	17
Oven interior	18
Inserting accessories	18
Turning on	18
After every use	19
Safety shut-off	19

<b>Timer functions</b>	<b>19</b>
Launching the timer menu	19
Timer	19
Stopwatch	20
Cooking time	21
End of cooking time	21
<b>Sabbath mode and Yom Tov mode</b>	<b>22</b>
Sabbath mode	22
Yom Tov mode	23
<b>Personal recipes</b>	<b>24</b>
Recording a recipe	24
Programming a recipe	24
Entering a name	25
Starting a recipe	25
Change recipe	25
Deleting a recipe	25
<b>Core temperature probe</b>	<b>26</b>
Insert the core temperature probe in the food to be cooked	26
Setting the core temperature	26
Core temperature guidelines	27
<b>Child lock</b>	<b>28</b>
Activating the child lock	28
Deactivating the child lock	28
<b>Factory setting</b>	<b>29</b>
<b>Cleaning and maintenance</b>	<b>31</b>
Cleaning agents	31
Cleaning aid	32
Drying program	33
Descaling program	33
Removing slide-in racks	34
<b>Troubleshooting</b>	<b>35</b>
Power cut	36
Demo mode	36
Replacing the oven interior lamp	36
<b>Customer service</b>	<b>36</b>

---

<b>Tables and tips</b>	<b>37</b>
Vegetables	37
Fish	38
Fish – low-temperature steaming	39
Meat – cooking at higher temperatures	40
Meat/poultry – low-temperature cooking	41
Poultry	42
Side dishes	42
Desserts	43
Other	43
Baked goods	44
Refreshing (warming up)	45
Dough proving (leaving to rise)	45
Defrosting	46
Preserving	47
Extracting juice (soft fruits)	47
Preparing yoghurt	48
Preparing bulky food	48
Acrylamide in foodstuffs	48

Additional information on products, accessories, replacement parts and services can be found at [www.gaggenau.com](http://www.gaggenau.com) and in the online shop [www.gaggenau.com/zz/store](http://www.gaggenau.com/zz/store)

---

## Safety Definitions

---

---

### **WARNING**

---

This indicates that death or serious injuries may occur as a result of non-observance of this warning.

---

---

### **CAUTION**

---

This indicates that minor or moderate injuries may occur as a result of non-observance of this warning.

---

**NOTICE:** This indicates that damage to the appliance or property may occur as a result of non-compliance with this advisory.

**Note:** This alerts you to important information and/or tips.



# IMPORTANT SAFETY INSTRUCTIONS

READ AND SAVE THESE INSTRUCTIONS

## IMPORTANT SAFEGUARDS

## SAVE THESE INSTRUCTIONS.

---

### WARNING

When properly cared for, your new appliance has been designed to be safe and reliable. Read all instructions carefully before use. These precautions will reduce the risk of burns, electric shock, fire, and injury to persons. When using kitchen appliances, basic safety precautions must be followed, including those in the following pages.

---

## Proper Installation and Maintenance

Have the installer show you the location of the circuit breaker or fuse. Mark it for easy reference.

This appliance must be properly installed and grounded by a qualified technician. Connect only to properly grounded outlet. Refer to Installation Instructions for details.

This appliance is intended for normal family household use only. It is not approved for outdoor use. See the Statement of Limited Product Warranty. If you have any questions, contact the manufacturer.

Do not store or use corrosive chemicals, vapors, flammables or nonfood products in or near this appliance. It is specifically designed for use when heating or cooking food. The use of corrosive chemicals in heating or cleaning will damage the appliance and could result in injury.

Do not operate this appliance if it is not working properly, or if it has been damaged. Contact an authorized servicer.

Do not obstruct oven vents.

Do not repair or replace any part of the appliance unless specifically recommended in this manual. Refer all servicing to an authorized servicer.

---

### WARNING

#### Risk of burns

To avoid risk of injury, turn off the interior light before cleaning the oven to allow the bulbs to cool down. The bulbs can become very hot when switched on. Keep the light off while cleaning the oven.

---

---

### WARNING

Make sure the appliance and lights are cool and power to the appliance has been turned off before replacing the light bulb(s). Failure to do so could result in electrical shock or burns. The lenses (if equipped) must be in place when using the appliance. The lenses (if equipped) serve to protect the light bulb from breaking. The lenses (if equipped) are made of glass. Handle carefully to avoid breaking. Broken glass can cause an injury.

---

---

### WARNING

Light socket is live when door is open if main power supply is not turned off.

---

---

### WARNING

Risk of short circuiting! Never allow electrical appliance cords to become pinched in the hot appliance door. The cord's insulation can melt.

---

## Fire Safety

---

### WARNING

NEVER cover any slots, holes or passages in the oven bottom or cover an entire rack with materials such as aluminum foil. Doing so blocks air flow through the oven. Aluminum foil linings may also trap heat, causing a fire hazard.

---

If materials inside an oven or warming drawer should ignite, keep door closed. Turn off the appliance and disconnect the circuit at the circuit breaker box.

# IMPORTANT SAFETY INSTRUCTIONS

## READ AND SAVE THESE INSTRUCTIONS

---

### WARNING

---

Use this appliance only for its intended use as described in this manual. NEVER use this appliance as a space heater to heat or warm the room. Doing so may result in overheating the appliance. Never use the appliance for storage.

---

Always have a working smoke detector near the kitchen.

In the event that personal clothing or hair catches fire, drop and roll immediately to extinguish flames.

Have an appropriate fire extinguisher available, nearby, highly visible and easily accessible near the appliance.

Smother flames from food fires other than grease fires with baking soda. Never use water on cooking fires.

---

### WARNING

---

TO REDUCE THE RISK OF INJURY TO PERSONS IN THE EVENT OF A GREASE FIRE, OBSERVE THE FOLLOWING:

- a) SMOTHER FLAMES with a close-fitting lid, cookie sheet, or metal tray, then turn off the burner. BE CAREFUL TO PREVENT BURNS. If the flames do not go out immediately, EVACUATE AND CALL THE FIRE DEPARTMENT.
  - b) NEVER PICK UP A FLAMING PAN – You may be burned.
  - c) DO NOT USE WATER, including wet dishcloths or towels – a violent steam explosion will result.
  - d) Use an extinguisher ONLY if:
    - You know you have a Class ABC extinguisher, and you already know how to operate it.
    - The fire is small and contained in the area where it started.
    - The fire department is being called.
    - You can fight the fire with your back to an exit.
- 

### Burn Prevention

DO NOT TOUCH HEATING ELEMENTS OR INTERIOR SURFACES OF OVEN - Heating elements may be hot even though they are dark in color. Interior surfaces of an oven become hot enough to cause burns. During and after use, do not touch, or let clothing, potholders, or other flammable materials contact heating elements or interior surfaces of oven until they have had sufficient time to cool. Other surfaces of the appliance may become hot enough to cause burns. Among these surfaces are oven vent openings, surfaces near these openings and oven doors.

Exercise caution when opening the appliance. Standing to the side, open the door (or drawer) slowly and slightly to let hot air and/or steam escape. Keep your face clear of the opening and make sure there are no children or pets near the unit. After the release of hot air and/or steam, proceed with your cooking. Keep doors shut unless necessary for cooking or cleaning purposes. Do not leave open doors unattended.

Do not heat or warm unopened food containers. Build-up of pressure may cause the container to burst and cause injury.

Always place oven racks in desired location while oven is cool. Always use oven mitts, when the oven is warm. If a rack must be moved while oven is hot, do not let potholder contact the heating elements.

---

### CAUTION

---

To avoid possible injury or damage to the appliance, ensure rack is installed exactly per installation instructions and not backwards or upside down.

---

Always use dry potholders. Moist or damp potholders on hot surfaces may result in burns from steam. Do not let potholder touch hot heating elements. Do not use a towel or other bulky cloth.

---

### WARNING

---

#### Scalding hazard

Movement when opening the appliance door and when removing the cookware can cause hot liquid to spray out. Do not stand too close to the appliance when opening it. Open appliance door carefully. Remove cookware carefully. Keep children away.

---



# IMPORTANT SAFETY INSTRUCTIONS

## READ AND SAVE THESE INSTRUCTIONS

Secure all loose garments, etc. before beginning. Tie long hair so that it does not hang loose, and do not wear loose fitting clothing or hanging garments, such as ties, scarves, jewelry, or dangling sleeves.

Use caution when cooking foods with high alcohol content (e.g. rum, brandy, bourbon) in the oven. Alcohol evaporates at high temperatures. There is a risk of burning as the alcohol vapors may catch fire in the oven. Use only small quantities of alcohol in foods, and open the oven door carefully.

---

### WARNING

#### Risk of scalding

Hot liquid may spill over the sides of cooking accessories when they are removed from the cooking compartment. Carefully remove cooking accessories with oven mitts.

---

### WARNING

#### Risk of scalding

Hot steam can escape when you open the appliance door. Steam is not visible at certain temperatures. Do not stand too close to the appliance when opening it. Open the appliance door with caution. Keep children away.

---

### WARNING

#### Risk of burns

Hot steam can leak during operation. Do not touch the ventilation openings. Keep children away.

---

### WARNING

#### Risk of scalding

Even after switching off, the water in the evaporator tray is still hot. Do not empty the evaporator tray immediately after switching off. Allow the appliance to cool down before cleaning it.

## Child Safety

When children become old enough to use the appliance, it is the responsibility of the parents or legal guardians to ensure that they are instructed in safe practices by qualified persons.

Do not allow anyone to climb, stand, lean, sit, or hang on any part of an appliance, especially a door, warming drawer, or storage drawer. This can damage the appliance, and the unit may tip over, potentially causing severe injury.

Do not allow children to use this appliance unless closely supervised by an adult. Children and pets should not be left alone or unattended in the area where the appliance is in use. They should never be allowed to play in its vicinity, whether or not the appliance is in use.

---

### CAUTION

Items of interest to children should not be stored in an appliance, in cabinets above an appliance or on the backsplash. Children climbing on an appliance to reach items could be seriously injured.

## Cleaning Safety

Risk of severe burns! Do not clean the appliance immediately after turning it off. The water in the evaporator dish is still hot. Wait until the appliance has cooled down.

Keep oven free from grease build up.

---

### WARNING

#### Risk of injury

Scratched glass in the appliance door can burst. Do not use any glass scrapers or strong or abrasive cleaning agents.

---

### WARNING

#### Risk of electrical shock

Moisture entering the appliance can cause an electrical shock. Don't use a high-pressure cleaner or steam cleaner.

# **IMPORTANT SAFETY INSTRUCTIONS**

## READ AND SAVE THESE INSTRUCTIONS

### **Cookware Safety**

Do not place food directly on oven bottom.

Follow the manufacturer's directions when using cooking or roasting bags.

---

#### **WARNING**

---

##### **Risk of electric shock**

Use of a wrong core temperature probe can damage the insulation. Use only the core temperature probe intended for this appliance.

---

Ovenware must be heat and steam resistant. Silicone baking pans are not suitable for Combination mode.

When using Steam mode with a perforated cooking pan, always slide the baking pan underneath it. The pan will catch any drippings.

The oven bottom and the evaporator dish must always remain clear. Always place ovenware on the rack or in the perforated cooking pan.

### **State of California Proposition 65 Warnings**

---

#### **WARNING**

---

This product can expose you to chemicals including vinyl chloride, which is known to the State of California to cause cancer and birth defects or other reproductive harm. For more information go to [www.P65Warnings.ca.gov](http://www.P65Warnings.ca.gov).

---

---

## Causes of damage

---

### NOTICES:

- Do not place anything directly on the oven floor. Do not line it with aluminum foil. Heat build-up can damage the appliance.
- The oven bottom and the evaporator tray should always remain clear. Always place dishes in a perforated baking pan or on a rack.
- Aluminum foil may not contact the door pane in the oven. This can cause permanent discoloration of the door pane.
- We recommend you use a mineral water low in chloride and without added carbonic acid if the mains water contains large amounts of chloride (>40 mg/l). You can inquire with your waterworks to obtain information about your mains water.
- Dishes must be heat and steam resistant. Silicone baking dishes are not suited for combination operation with steam.
- Use only original accessories in the oven interior. Rusting material (such as serving platters or knives and forks) can cause corrosion in the oven interior.
- Use original small parts (e.g. knurled nuts) only. Reorder small parts through out spare parts service if these should be lost.
- When steaming with a perforated baking dish, always push the baking sheet or the unperforated baking dish beneath it. This will catch drippings.
- Do not leave moist groceries in a closed oven for an extended period of time. It can lead to corrosion inside the oven.
- Salt, spicy sauces (e.g. ketchup or mustard) or salted dishes (e.g. cured roast) contain chlorides and acids. These corrode the surfaces of stainless steel. Always remove residues immediately.
- Fruit juice can leave stains in the oven. Always remove fruit juice immediately when safe to touch, and wipe up first with a damp and then a dry cloth.
- Your appliance's oven interior consists of high-grade stainless steel. Corrosion can occur in the oven interior if it is not cared for properly. Observe the care and cleaning notes in the operating instructions. After every use, clean the oven interior straight after the appliance has cooled down. After cleaning, dry the oven interior with the drying program.

- Do not detach the door seal. The appliance door will no longer close properly if the door seal is damaged. Adjoining furniture frontages may be damaged. Have the door seal replaced.
- Do not hold or carry the appliance by the door handle. The door handle cannot carry the weight of the device and could break off.

---

## Environmental protection

---

Unpack the appliance and dispose of the packaging in an environmentally friendly manner.

### Saving energy

- Open the appliance door as little as possible while cooking.
- Use dark, black-painted or enamelled baking forms. These absorb the heat particularly well.
- It is best to bake several cakes in succession. The steam oven is still warm. This shortens the baking time for the second cake. You can also slide in two loaf tins next to each other.
- For longer cooking times, you can switch off the steam oven 10 minutes before the end of the cooking time and you can use the residual heat to finish cooking.
- When steaming, you can cook simultaneously on several levels. If dishes require different cooking times, insert the dishes that require the longest time first.



---

## Getting to know the appliance

---

You will get to know your new appliance here. We explain the control panel and the individual controls to

you. You are informed about the oven interior and accessories.

### Combi-steam oven

These instructions apply to different versions of the appliance. Slight deviations are possible depending on the appliance type.

Operation is identical for all appliance versions.

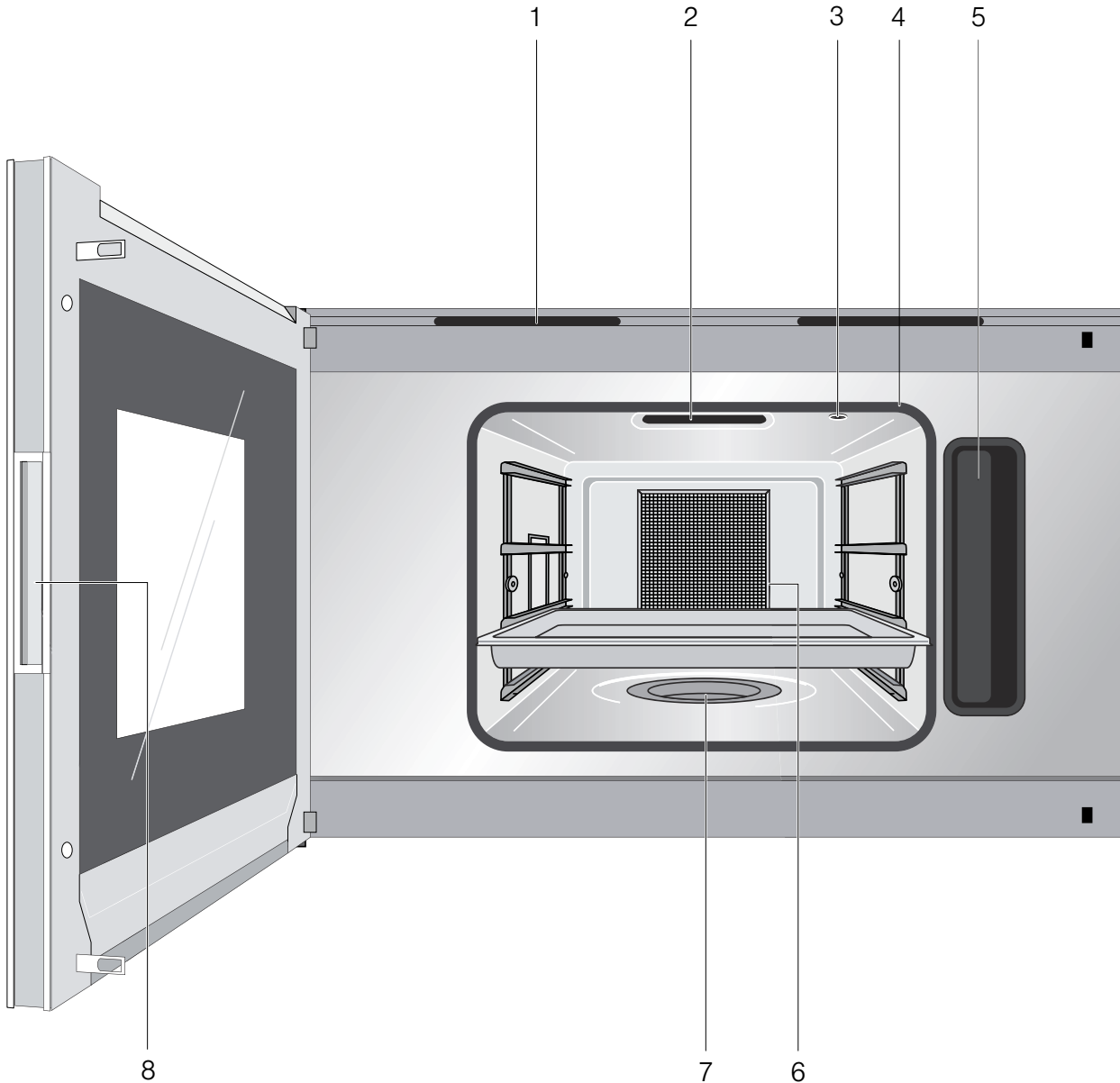

1	Ventilation slots
2	Ventilation flap
3	Socket for core temperature probe
4	Door seal
5	Water tank
6	Grease filter

7	Evaporator tray
8	Recessed handle

Do not obstruct oven vents.

**NOTICE:** Do not place food directly on oven bottom.

## Displays and controls

These instructions apply to different versions of the appliance. Slight deviations are possible depending on the appliance type.

Operation is identical for all appliance versions.

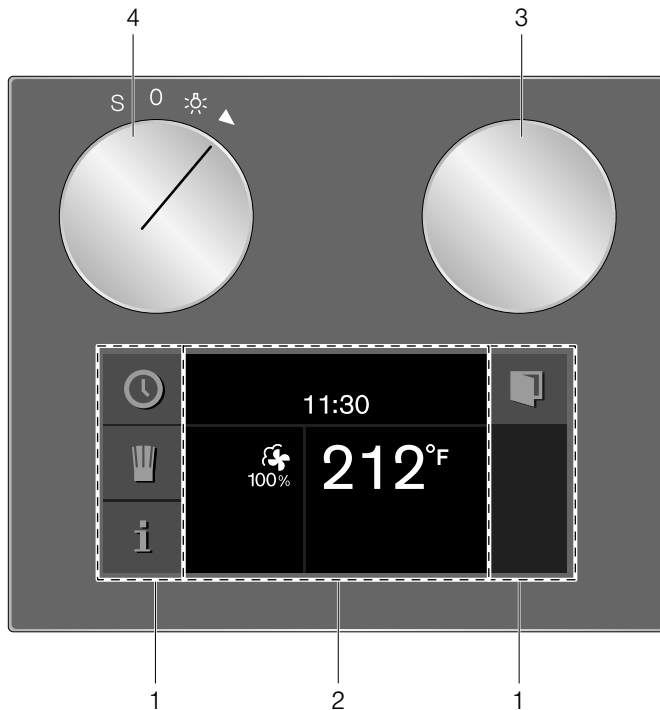

1	Control panel	These areas are touch-sensitive. Touch a symbol to select the applicable function.
2	Display	The display shows current settings and options, for example.
3	Rotary selector	With the rotary selector you can select the temperature and make other settings.
4	Program selector	With the program selector, you can select the heating function, the cleaning function or the basic settings.

## Symbols

Symbol	Function
▶	Start
■	Stop
	Pause/end
X	Cancel
C	Delete
✓	Confirm/save settings
>	Selection arrow
🔲	Open appliance door
i	Launching additional information

⤴	Preheating with status display
👤	Launching personal recipes
REC	Recording a menu
🔧	Edit settings
>A <sup>A</sup>	Enter a name
✕	Delete letters
🔒	Child lock
🕒	Launching the timer menu
🕒	Launching the Sabbath mode
🔪	Demo mode
🔥	Core temperature probe

## Colors and display

### Colors

The various colors serve to guide you in the various adjustment situations.

Orange	First settings
	Main functions
Blue	Basic settings
	Cleaning
White	Adjustable values

### Presentation

The presentation of symbols, values or the entire display changes depending on the situation.

Zoom	The display of the setting you are just changing is enlarged. Just before it elapses, a duration that is just elapsing is enlarged (e.g. the last 60 seconds in the case of timers).
Minimized display screen	After a short time, the display screen is minimized and only the most important things are displayed. This function is the default and can be modified in the basic settings.

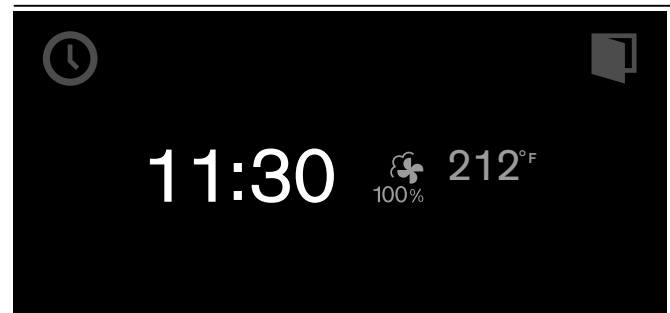

## Additional information **i** and **i**<sup>Ⓢ</sup>

By touching the **i** symbol, you can call up additional information. For example, information on the heating function set or on the current temperature of the cooking compartment.

**Note:** During continuous operation, small fluctuations in temperature are normal after the oven has heated up.

The **i**<sup>Ⓢ</sup> symbol is displayed for important information and action prompts. Important information on safety and operation mode are occasionally shown automatically. These messages either disappear automatically after a few seconds or must be confirmed with **✓**.

## Cooling fan

Your appliance has a cooling fan. The cooling fan switches on during operation. Depending on the appliance version, the warm air escapes above or under the door.

After removing cooked food, keep the door closed until the appliance cools down. The appliance door must not be left ajar, as adjoining kitchen furniture may be damaged. The cooling fan continues to run for a while and then switches off automatically.







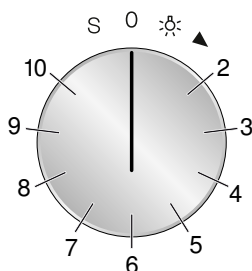

### **⚠ CAUTION**

Do not cover up the ventilation slots. Otherwise, the appliance will become overheated.

## Program selection positions



Position	Function/heating function	Temperature	Application
0	Off position		
	Light		
2	Convection + 100% Humidity	85 - 450° F (30 - 230°C) Default temperature 212° F (100°C)	Steaming at 160 - 212° F (70°C - 100°C): For vegetables, fish and side dishes. Meals are surrounded entirely by steam Combined operation at 250 - 450° F (120°C - 230°C): for puff pastry, bread and bread rolls. Convection and steam are combined.
3	Convection + 80% Humidity	85 - 450° F (30 - 230°C) Default temperature 340° F (170°C)	Combined operation: for puff pastry, meat and poultry. Convection and steam are combined.
4	Convection + 60% Humidity	85 - 450° F (30 - 230°C) Default temperature 340° F (170°C)	Combined operation: for yeast-risen pastries and bread. Convection and steam are combined.
5	Convection + 30% Humidity	85 - 450° F (30 - 230°C) Default temperature 340° F (170°C)	Cooking in intrinsic steam: for cakes and cookies When you select this mode, no steam is generated, but the ventilation flap is closed. Thus, the moisture escaping from the food stays in the oven interior and prevents drying out of prepared foods.
6	Convection + 0% Humidity	85 - 450° F (30 - 230°C) Default temperature 340° F (170°C)	Hot air: for cakes, cookies and soufflés. The fan on the rear wall distributes the heat evenly in the oven interior

Position	Function/heating function	Temperature	Application
7	 Dough proofing	85 - 120° F (30 - 50° C) Default temperature 100° F (38° C)	Raising: for yeast and sour dough. The dough rises much faster than at room temperature. Hot air and steam are combined to ensure the dough surface does not dry out. The optimum temperature setting for yeast dough is 100° F (38° C).
8	* Defrosting	100 - 140° F (40 - 60° C) Default temperature 115° F (45° C)	For vegetables, meat, fish and fruit. Thanks to the moisture, heat is transferred to meals evenly. Meals do not dry out and do not lose their shape.
9	 Refreshing	140 - 360° F (60 - 180° C) Default temperature 250° F (120° C)	For cooked and baked food. Pre-cooked food is gently heated up again. Thanks to the supply of steam, cooked food is not dried out. Refreshing pre-cooked meals on a plate at 250° F (120° C) and baked items at 360° F (180° C).
10	 Low-temperature cooking	85 - 200° F (30 - 90° C) Default temperature 160° F (70° C)	Low-temperature cooking for meat. Gentle, slow cooking for a particularly tender result.
S	 Factory setting		In the basic settings, you can adapt your appliance individually.
	 Cleaning aid		The cleaning aid removes soiling with steam.
	 Drying program		The drying program dries the oven interior after steaming or cleaning.
	 Descaling program		With the descaling program you remove scale from the oven interior.
	 Delete descaling reminder		Clear the descaling reminder in the display after the descaling process.

## Accessories

Use only the accessories included or obtainable from after-sales service. It has been specially adapted to your appliance. Make sure you always insert accessories into the interior the right way round.

Your appliance comes with the following accessories:



**Rack**  
for cookware, cake pans and casseroles and for roasts

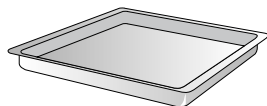

**Stainless steel cooking receptacle, unperforated, GN 2/3, 40 mm deep**  
for cooking rice, pulses and cereals, for baking cake baked on trays and for collecting dripping liquid during steaming

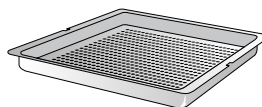

**Stainless steel cooking receptacle, GN 2/3, 40 mm deep**  
for steaming vegetables or fish, for extracting berry juices and for thawing

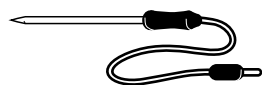

**Core temperature probe**  
for precise preparation of meat, fish, poultry and bread

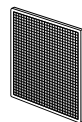

**Grease filter**  
protects the fan on the rear of the oven interior from soiling (e.g. by roast splashes)

## Special accessories

You can order the following accessories from your specialist dealer:

- BA 476 310 Handle, stainless steel
- GN 114 130 Stainless steel cooking insert GN 1/3, unperforated, 1½" (40 mm) deep, 1.5 l
- GN 114 230 Stainless steel cooking insert GN 2/3, unperforated, 1½" (40 mm) deep, 3 l
- GN 124 130 Stainless steel cooking insert GN 1/3, perforated, 1½" (40 mm) deep, 1.5 l
- GN 124 230 Stainless steel cooking insert GN 2/3, perforated, 1½" (40 mm) deep, 3 l
- GN 340 230 Cast aluminum roaster GN 2/3, 6½" (165 mm) high, non-stick
- GN 410 130 Stainless steel cover GN 1/3
- GN 410 230 Stainless steel cover GN 2/3
- GR 220 046 Wire rack, chrome-plated, with feet

Use the accessories only as indicated. The manufacturer assumes no liability for incorrect usage of the accessories.

---

## Before using the appliance for the first time

---

- Appliance must be properly installed by a qualified technician before use.
- Remove all packing materials from inside and outside the oven.
- While cool, wipe with a clean, damp cloth and dry.
- There may be a slight odor from your new appliance; this is normal and will disappear after a short time.
- Optimum cooking results depend on proper cookware being used.
- Read and understand all safety precautions and Use and Care Manual information.

### Execute the following sections prior to operating:

The "First settings" menu appears in the display after the mains has been connected. You can now set your new appliance:

- Language
- Time format
- Time
- Date format
- Date
- Temperature format
- Water hardness

The appliance must be completely fitted and connected.

### Notes

- The "Initial settings" menu only appears when you first connect the power or if the appliance has been without power for several days. After connecting the power, first the GAGGENAU logo appears for approx. 30 seconds, then the "Initial settings" menu appears automatically.
- You can change these settings at any time (see the "Basic settings" chapter).

## Setting the language

The default language appears in the display.

- 1 Select the desired display language with the rotary selector.
- 2 Confirm with ✓.

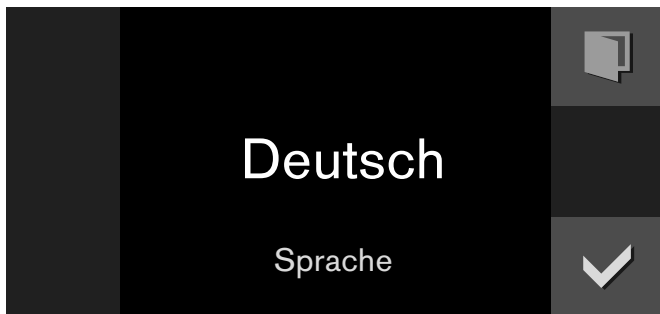

**Note:** When the language is changed, the system is restarted; this procedure takes a few seconds.

## Setting the time format

the two possible formats 24h and AM/PM appear in the display. The default format is 24h.

- 1 Set the required format with the rotary selector.
- 2 Confirm with ✓.

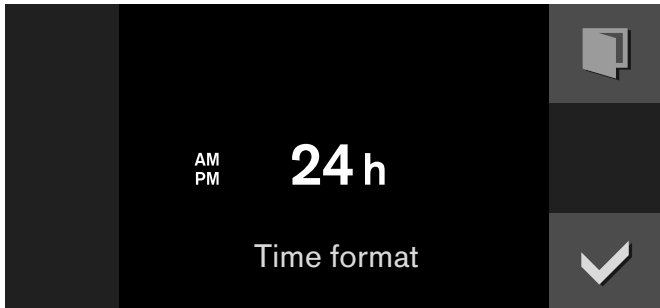

## Setting the time

The time appears in the display.

- 1 Set the required time with the rotary selector.
- 2 Confirm with ✓.



## Setting the date format

The three possible formats D.M.Y, D/M/Y and M/D/Y appear in the display. The D.M.Y is the default.

- 1 Set the required format with the rotary selector.
- 2 Confirm with ✓.

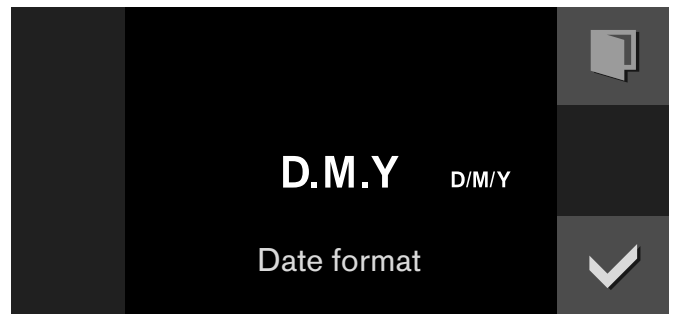

## Setting the date

The default date appears in the display. The day setting is already active.

- 1 Set the required day with the rotary selector.
- 2 Switch to the month setting with the > symbol.
- 3 Set the month with the rotary selector.
- 4 Switch to the year setting with the > symbol.
- 5 Set the year with the rotary selector.
- 6 Confirm with ✓.

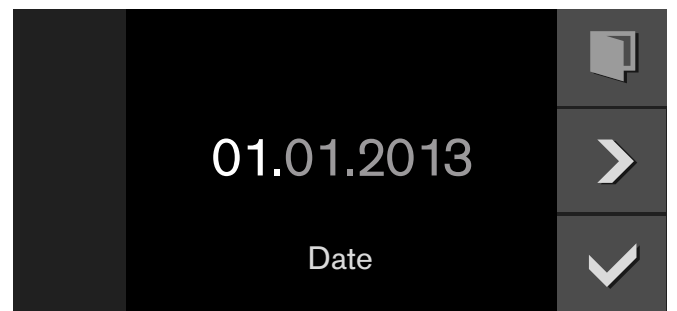

## Setting the temperature format

The two possible formats °C and °F appear in the display. The °C format is selected by default.

- 1 Set the required format with the rotary selector.
- 2 Confirm with ✓.

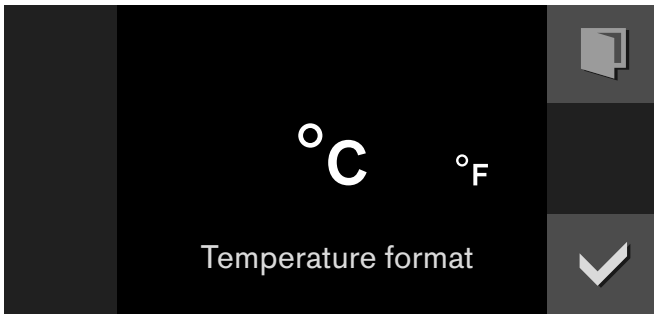

## Setting water hardness

"Water hardness" appears in the display.

- 1 Check the mains water with the included carbonate hardness test: fill the small measurement tube with mains water up to the 5 ml mark.
- 2 Add drops of indicator solution until the color changes from purple to yellow.  
**Important:** count the drops and carefully swing the measurement tube after every drop until the liquids have mixed thoroughly. The number of drops corresponds to the water hardness.
- 3 Set the measured water hardness with the rotary selector. The value 12 is set by default.
- 4 Confirm with ✓.

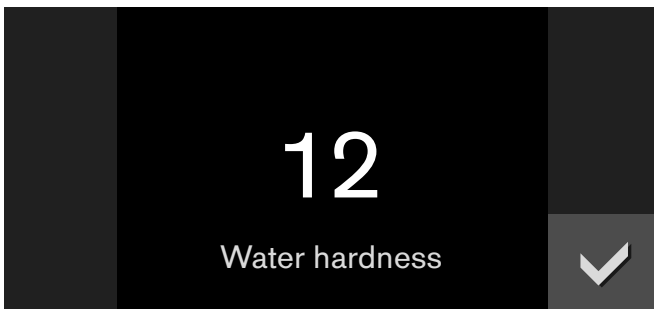

## Completing initial set-up

"Initial set-up complete. Please calibrate the appliance before first cooking" appears in the display.

Confirm with ✓.

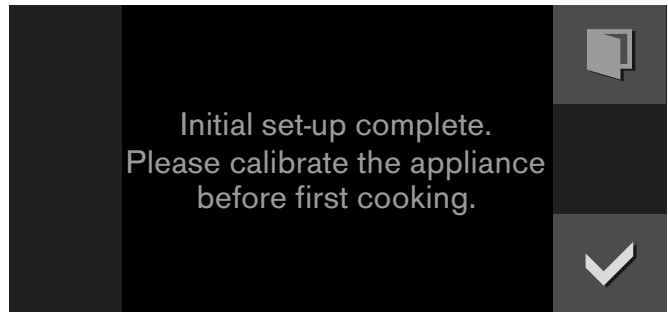

The appliance enters the standby mode and the standby display appears. The appliance is now ready for operation.

Calibrate the appliance before steaming for the first time. The appliance sets the boiling point.

## Calibrating

The boiling point of water depends on barometric pressure. As air pressure drops with increasing elevation, the boiling point drops as well. During calibration, the appliance sets the boiling point to the pressure conditions at the place where it is installed.

It is important for the appliance to steam for 20 minutes at 212° F (100° C) without interruption. Do not open the appliance door during this time.

### Notes

- Calibrate the appliance only when it is cold.
  - During calibration, the appliance generates more steam than it normally would do.
- 1 Set the program selection to **S**.
  - 2 Select "Factory setting" with the rotary selector..
  - 3 Touch the ✓ symbol.
  - 4 Select "Calibration" with the rotary selector.
  - 5 Touch the ↵ symbol.
  - 6 Fill the water tank with cold water and touch the ✓ symbol.
  - 7 Remove all accessories from the oven interior and touch the ✓ symbol.

- 8 The duration of 20.00 minutes appears. Start calibration with ▶.

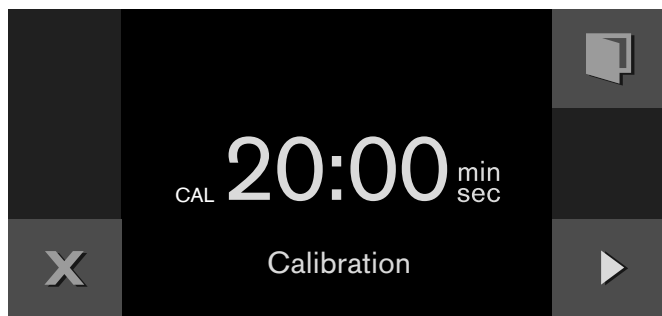

Calibration begins. The elapsing time is shown on the display.

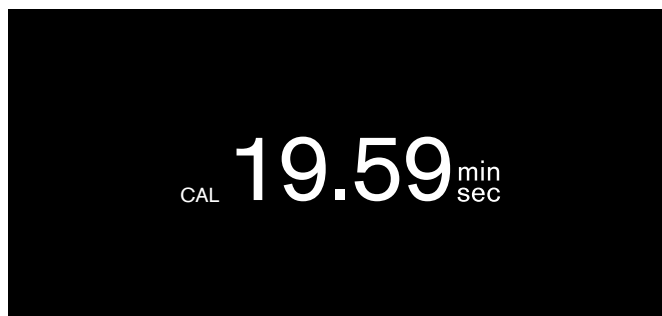

**Note:** Do not interrupt calibration. Do not change the program selection. Do not open the appliance door.

A message appears in the display once calibration has ended. Confirm with ✓ and turn the program selection to 0.

**After a removal**

Repeat calibration so that the appliance will automatically adapt again to the new location.

**After resetting to factory settings**

After resetting to factory settings in the basic settings menu the appliance has to be recalibrated.

**After a power failure**

The appliance saves the calibration settings, even after a power failure or a disconnection from the mains. It need not be recalibrated.

## Grease filter

Hook the included grease filter onto the hot air grill in the rear panel of the oven interior.

Leave the grease filter inside the appliance during every use. Clean the grease filter after every highly soiling use with hot soapy solution or in a dishwasher.

## Cleaning accessories

Before using accessories for the first time, thoroughly clean them with hot soapy water and a soft dish cloth.



## Activating the appliance

### Standby

The appliance is in the standby mode when no function is set or the child lock is activated.

The control panel's brightness is reduced in the standby mode.

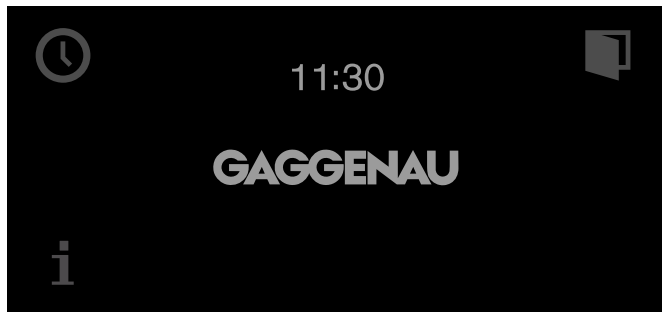

#### Notes

- There are various displays for the standby mode. The GAGGENAU logo and the time are set by default. Refer to the section entitled **Factory setting** if you would like to change the display.
- The display's brightness depends on the vertical viewing angle. You can adjust the display by way of the "Brightness" setting in the factory settings.

### Activate appliance

In order to exit standby mode, you can either

- Set the function selector,
- Touch a control panel,
- or open or close the door.

Now you can set the desired function. Read the appropriate chapters to learn how to set functions.

#### Notes

- If "Standby screen = off" is selected in the factory setting, you must turn the function selector to exit the standby mode.
- The standby display appears again if you have not made any settings for a long while after activation.
- The cooking compartment lighting goes out after a little while if the door is open.

## Operating the appliance

### Filling the water tank

When you open the appliance door, you see the water tank at the side.

**NOTICE:** Use of inappropriate liquids can damage the appliance!

- Only use fresh tap water, softened water, or mineral water without carbonation.
- If your tap water contains a lot of lime, we recommend softened water.
- Do not use distilled water, highly chlorinated tap water (> 40 mg/l), or any other liquids.

Information about your tap water can be obtained from your water utility office. The hardness of your water can be tested with the accompanying test strip.

Fill the water tank before every operation (except for "Convection + 30% Humidity", "Convection + 0% Humidity" and "Drying program"):

- 1 Open the appliance door and remove the water tank (Figure A).
- 2 Fill the water tank with cold water up to the "max" mark (Figure B).

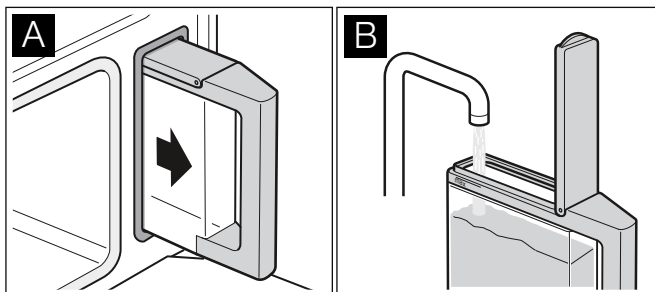

- 3 Close the tank cover until it noticeably engages.
- 4 Completely push in the water tank (Figure C).

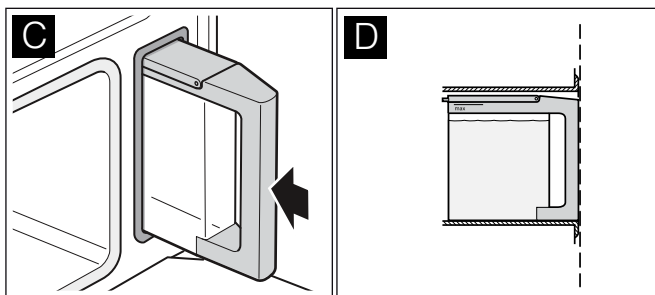

The tank must be flush with the tank slot (Figure D).

## Oven interior

The oven interior has four insertion levels. These are counted from the bottom up.

**Note:** When steaming, thawing, fermenting and regenerating, you can use up to three insertion levels at the same time (levels 2, 3 and 4). You can only bake on one level, and you should use level 2 to do this (or level 1 for higher cake pans).

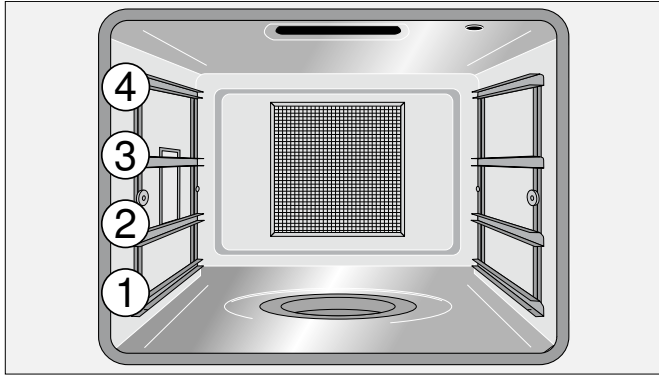

### ⚠ CAUTION

Do not place anything on the cooking compartment floor. Do not cover it with aluminium foil. A build-up of heat could damage the appliance or cause injury.

### ⚠ CAUTION

The oven interior's floor and the evaporator tray must always be left free. Always place cookware in the perforated cooking receptacle or on the rack.

### ⚠ CAUTION

Do not insert any accessories between the levels as otherwise it may tilt over.

Always open the appliance door fully. In this position the open appliance door does not swing back of its own accord.

## Inserting accessories

The rack and the perforated cooking receptacle feature a latching function. The latching function prevents tilting of accessories when pulling them out. You must insert accessories in the cooking interior correctly so that tilt protection will work. When removing accessories, you must raise them slightly.

When inserting the rack, make sure

- that the engaging lug (a) points upward
- that the rack's safety clip is at the rear and top.

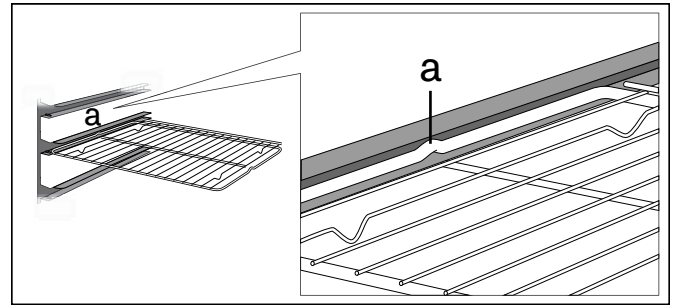

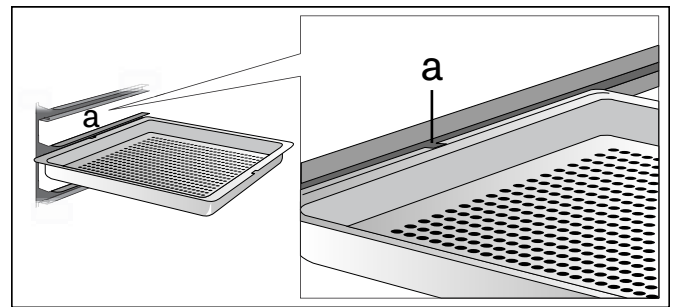

When pushing in the perforated cooking receptacle, make sure that the recess (a) points to the side.



## Turning on

- 1 Set the required heating function with the program selection. The chosen heating function and the default temperature are displayed.
- 2 If you would like to change the temperature: set the required temperature with the rotary selector.

The preheating symbol  appears on the display. The bar continuously shows the preheating status. When the set temperature is reached, a signal sounds and the preheating symbol  goes off.

**Note:** The oven interior lighting stays switched off at a temperature setting below 160° F (70° C).

### Topping up water:

a message appears in the display when the water tank is empty. Fill the water tank up to the "max" mark and insert it again.

### Switching off:

Set program selection to 0.

## After every use

### Empty water tank

- 1 Open the appliance door carefully.  
Hot steam can escape!
- 2 Remove and empty water tank.
- 3 Dry the tank lid and tank duct in the appliance well.

---

#### CAUTION

Do not dry the water tank in the hot oven. This will damage the water tank.

---

### Drying the oven interior

---

#### WARNING

##### Risk of scalding

The water in the evaporator tray may be hot. Let it cool down before emptying it.

---

- 1 Remove soiling from the oven interior as soon as it has cooled down. Baked-in residue is much harder to remove later on.
- 2 Empty the evaporator tray with the included cleaning sponge.
- 3 Wipe out the cooled down oven interior and the evaporator tray with the cleaning sponge and dry them well with a soft cloth.
- 4 Wipe furnishings or handles dry if condensate has collected on them.
- 5 Dry the oven interior with the drying program (see section entitled **Drying program**) or leave the appliance door open until the interior has dried completely.

## Safety shut-off

For your protection, the appliance has a safety shut-off feature. Every heating operation is switched off after 12 hours if the appliance is not operated during this time. A message appears in the display.

Exception:  
programming with the long-term timer.





Turn the program selection to **0**, after which you can operate the appliance in the manner to which you are accustomed.

---

## Timer functions

---

In the timer menu, set:

-  Timer
-  Stopwatch
-  Cooking time (not in the idle state)
-  Cooking time end (not in the idle state)

## Launching the timer menu

You can launch the timer menu from any mode. Only from the factory settings, program selection is set to **S**, the time menu is not available.

Touch the  symbol.

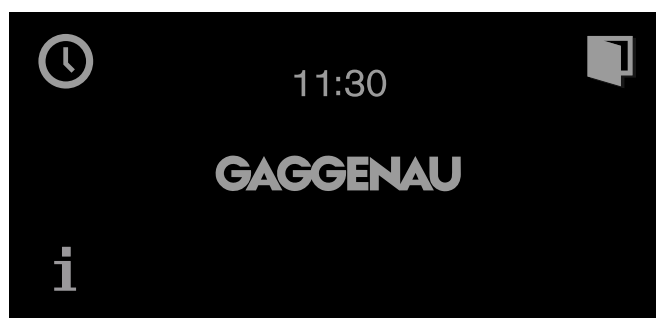

The timer menu appears.

## Timer

The timer runs independently of the other appliance functions. You can enter a maximum of 90 minutes.

### Setting the timer

- 1 Call up the Timer menu.  
The "Timer" function  is displayed.
- 2 Turn the rotary selector to set the desired time.

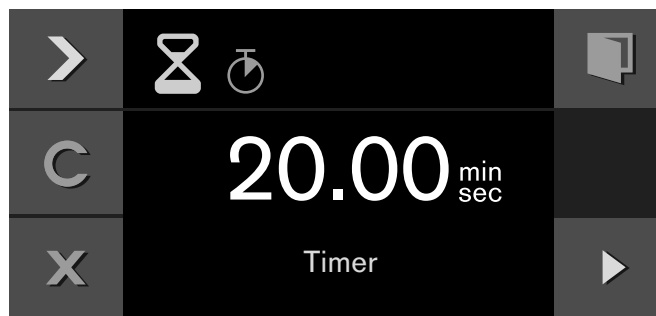

### 3 Start with ▶.

The Timer menu closes and the timer starts to run. The symbol for the timer ⌚ appears on the display and the time can be seen counting down.

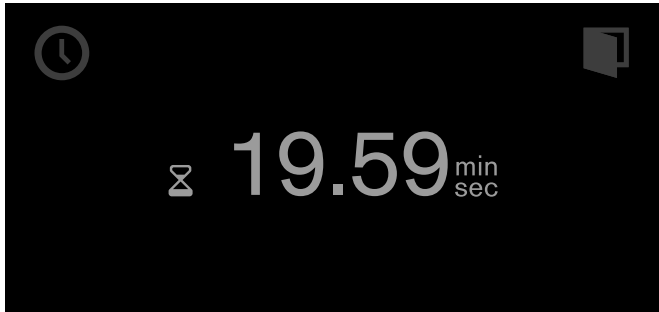

A signal sounds once the time has elapsed. The audible signal ceases if you touch the ✓ symbol.

You can exit the Timer menu at any time by touching the X symbol. This way, the settings are lost.

#### Suspend timer:

Call up the Timer menu. Select the "Timer" function with >, select ⌚, and touch the || symbol. To let the timer run on, touch the ▶ symbol.

#### Switch off the timer early:

Call up the Timer menu. Select the "Timer" function with >, select ⌚, and touch the C symbol.

## Stopwatch

The stopwatch runs independently of the other appliance functions.

The stopwatch counts up from 0 seconds to 90 minutes.

It has a pause function. Therefore, you can stop the timer in between times.

#### Starting the stopwatch

- 1 Launch the timer menu.
- 2 With >, select the "Stopwatch" function ⌚.

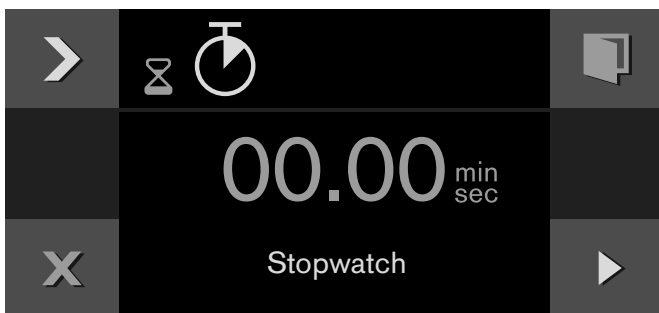

### 3 Start with ▶.

The timer menu is closed and the time runs. The ⌚ symbol and the elapsing timer are shown in the display.

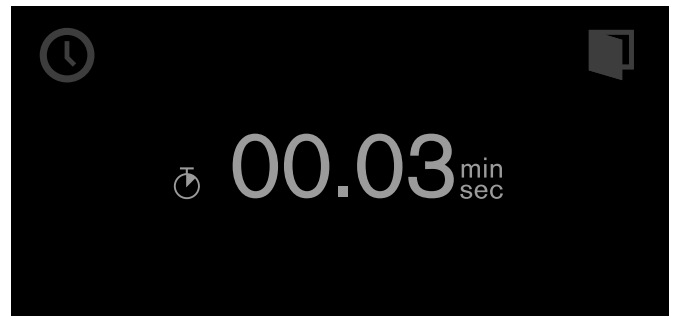

#### Stopping and restarting the stopwatch

- 1 Launch the timer menu.
- 2 With >, select the "Stopwatch" function ⌚.
- 3 Touch the || symbol.

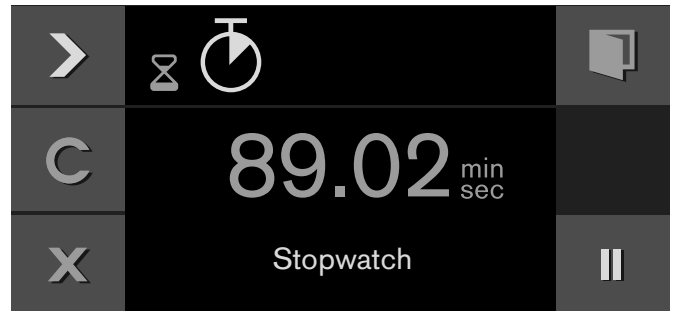

The time stops. The symbol changes to Start ▶ again.

#### 4 Start with ▶.

The time continues to run. Once 90 minutes have been reached, the display pulsates and a signal sounds. It goes off when you touch the ✓ symbol. The ⌚ symbol disappears from the display. The operation has ended.

#### Switching off the stopwatch:

Launch the timer menu. With >, select the "Stopwatch" function ⌚ and touch the C symbol.



## Cooking time

If you set a cooking time for your meal, the appliance switches off heating automatically after this time has elapsed.

You can set a cooking time from 1 minute to 23:59 hours.

### Setting the cooking time

You have set the heating function and temperature and you have placed your dish in the oven interior.

- 1 Touch the  symbol.
- 2 With , select the "Cooking time" function .
- 3 Set the required cooking time with the rotary selector.





- 4 Start with .

The appliance starts. The timer menu is closed. The temperature, the operating mode, the remaining cooking time and the end of the cooking time appear in the display



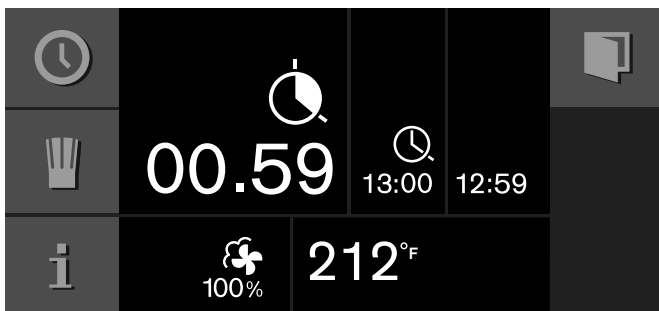

One minute before expiration of the cooking time, the expiring cooking time is enlarged in the display.







The appliance switches off after expiration of the cooking time. The  pulsates and a signal sounds. It goes off prematurely if you touch the  symbol, open the appliance door or set the program selection to 0.

### Changing the cooking time:

Launch the timer menu. With , select the "Cooking time" function . Set the cooking time with the rotary selector. Start with .

### Clearing the cooking time:

Launch the timer menu. With , select the "Cooking time" function . Clear the cooking time with . Return to normal operation with .

### Canceling the entire operation:

Set the program selection to 0.

**Note:** You can also change the heating function and temperature during the cooking time.

## End of cooking time

You can defer the end of the cooking time until later.



Example: it is 2 pm. The meal takes 40 minutes to cook. It should be ready by 3.30 pm.

Enter the cooking time and shift the end of the cooking time to 3.30 pm. The electronic circuitry calculates the starting time. The appliance starts automatically at 2:50 pm and switches off at 3.30 pm.

Note that easily perishable foodstuffs must not be left in the oven for too long.

### Shifting the end of the cooking time

You have set the heating function, the temperature and the cooking time.

- 1 Touch the  symbol.
- 2 With , select the "End of cooking time" function .





- 3 Set the required cooking time end with the rotary selector.

#### 4 Start with ▶.





The appliance assumes a waiting mode. The operating mode, the temperature, the cooking time and the end of the cooking time appear in the display. The appliance starts at the calculated time and switches off automatically when the cooking time has elapsed.

**Note:** If the  symbol flashes: you have not set a cooking time. Always set a cooking time first.

The appliance switches off after expiry of the cooking time. The  pulsates and a signal sounds. It goes off prematurely if you touch the  symbol, open the appliance door or set the program selection to 0.

#### Changing the cooking time end:

Launch the timer menu. With , select "End of cooking time" . Set the required cooking time end with the rotary selector. Start with ▶.

#### Canceling the entire operation:

Set the program selection to 0.

## Sabbath mode and Yom Tov mode

### Sabbath mode





With this function, the appliance maintains a temperature between 120 and 450°F (50 and 230°C) with the convection heating function.

You can keep dishes warm for up to 74 hours without having to switch on or off.



Note that easily perishable foodstuffs must not be left in the oven for too long.

**Note:** You must activate the Sabbath mode in the factory setting in order to operate the mode.



#### Follow these steps:

- 1 Set the program selector to S.
- 2 Select "Factory setting" with the rotary selector.
- 3 Confirm by touching the  symbol.
- 4 Rotate the selector to Sabbath mode .
- 5 Confirm by touching the  symbol.
- 6 Rotate the selector to "activate".
- 7 Confirm by touching the  symbol.
- 8 Turn the oven off.

#### Setting the Sabbath mode

- 1 Set the program selector to .
- 2 Touch the  symbol.  
The suggested value of 24h at 185° F (85° C) appears in the display. Start with ▶  
- or -  
Change the cooking time and the temperature.



- 3 Changing the cooking time  :  
Touch the  symbol. Set the preferred cooking time with the rotary selector. You can set up to 74 hours. Confirm by touching the  symbol. Then changing the temperature becomes an option.
- 4 Changing the temperature:  
Set the required temperature with the rotary selector.
- 5 Start with ▶.

The appliance starts.  and the temperature appear in the display. The Sabbath screen will appear as shown.



The oven and display lighting is off. The control panel is blocked and no tone can be heard when you touch it.

The appliance no longer heats after expiry of the time. The display is blank. Set the program selector to 0.

#### Switching off:

To cancel the operation, set the program selector to 0.

## Yom Tov mode

With this function, the appliance is programmed to perform in three stages.

Stage 1 and 2 can be programmed for a maximum total duration of 74 hours. The duration of Step 3 is 1 hour and cannot be modified.



**Stage 1:** maintains a warm temperature of 122° F (50°C) in the convection heating function. The interior oven lights remain off through this stage.

**Stage 2:** the appliance raises to a desired temperature setting and maintains a temperature between 120 and 450° F (50 -230°C). For warming and cooking foods in the convection heating function. The desired time can be adjusted for this stage. The interior oven lights will be on during this time.

**Stage 3:** maintains a warm temperature of 122° F (50°C) in the convection heating function for 1 hour after stage 2 has ended. The interior oven lights will be on during this time.

Note that easily perishable foodstuffs must not be left in the oven for too long.





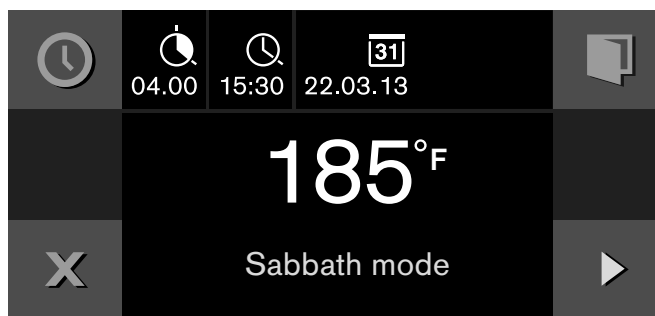

#### Setting the Yom Tov mode

- 1 Set the program selector to .
- 2 Touch the  symbol.

The suggested value of 24h at 185° F (85° C) appears in the display.



To set Stage 2 cooking time with rotary selector:

- 1 Touch the  symbol to adjust the duration of Stage 2 cooking time .
- 2 Set the desired Stage 2 cooking time with the rotary selector.
- 3 Touch the  symbol to adjust the end of Stage 2 cooking time .
- 4 Select the end time with the rotary selector.
- 5 Change the date if needed by touching the  symbol to .
- 6 Rotate the selector to the desired date.
- 7 Confirm settings by touching the  symbol.

To set Stage 2 temperature:

- 1 Rotate selector to desired Stage 2 temperature.
- 2 Start with .

The temperatures of Stage 1 and Stage 2 appear in the display. The remaining time to the beginning of Stage 2 is counted down in the display. The Yom Tov screen will appear as shown.

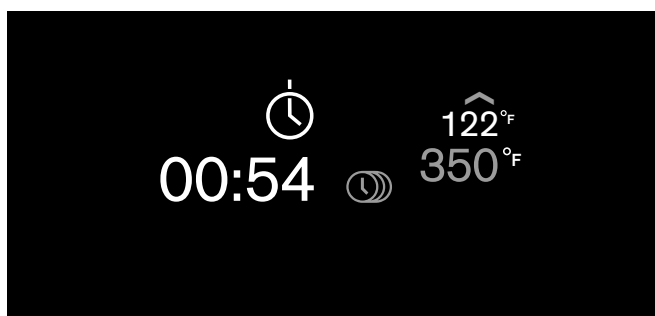

The program will begin with the pre-set warm temperature without light, then advance to the programmed temperature with light until the end of the set date and time, and then maintain the pre-set warm temperature for 60 minutes.

The appliance no longer heats after expiry of the time. The display is blank. Set the program selector to 0.

#### Switching off:



To cancel the operation, set the program selector to 0.

## Personal recipes

You can save up to 50 individual recipes. You can record a recipe. You can assign these recipes a name so that you can fall back on them quickly and conveniently if you need them.

### Recording a recipe

You can set up to five phases in succession and you can record them.

- 1 Set the program selection to the required heating function.  
The  symbol is displayed.
- 2 Touch the  symbol.
- 3 Choose a free storage location with the rotary selector.
- 4 Touch the  symbol.

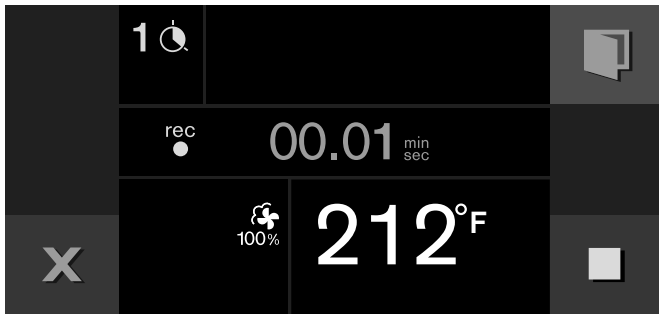



- 5 Set the desired temperature with the rotary selector.
- 6 The cooking time is recorded.
- 7 Recording another phase:  
Set the program selection to the required heating function. Set the required temperature with the rotary selector. A new phase begins.
- 8 Once the appliance has achieved the desired cooking result, touch the  symbol to end the recipe.
- 9 Enter the name under "ABC" (see section "Entering a name").

#### Notes





- Recording a phase does not begin until the appliance has reached the set temperature.
- Every phase must last at least one minute.
- During the first minute you can change the heating function or the temperature.

#### Enter the core temperature for a phase:





Insert the core temperature probe in the socket in the oven interior. Set the heating function and temperature. Touch the  symbol. With the rotary selector, enter the required temperature and confirm it with .

### Programming a recipe



You have the option of programming and saving up to five phases of preparation.

- 1 Set the program selection to the required heating function. Set the required temperature with the rotary selector.  
The  symbol is displayed.
- 2 Touch the  symbol.
- 3 Choose a free storage location with the rotary selector..
- 4 Touch the  symbol.
- 5 Enter the name under "ABC" (see section "Entering a name").
- 6 Choose the first phase with the  symbol.  
The heating function and temperature set at the start are displayed. You can change the heating function and temperature with the rotary selectors.



- 7 Choose the time setting with the  symbol.
- 8 Set the required cooking time with the rotary selector.
- 9 Choose the next phase with the  symbol.  
- or -  
Preparation is complete, end input.
- 10 Save with .  
- or -  
Cancel with  and quit the menu.

#### Enter the core temperature for a phase:

Choose the next phase with the  symbol. Set the heating function and temperature. Touch the  symbol. With the rotary selector, enter the required temperature and confirm it with .

**Note:** For phases for which a core temperature has been programmed you cannot set a cook time.



## Entering a name

- 1 Enter the recipe's name under "ABC".

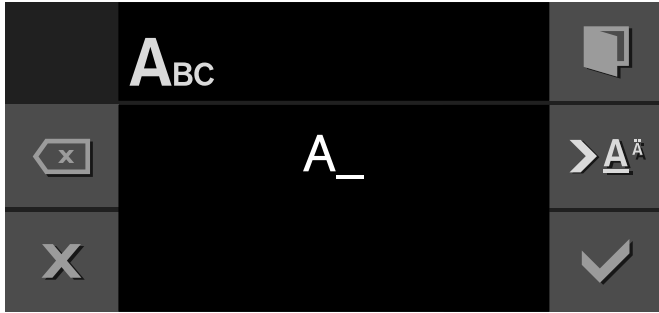

Rotary selector	Selecting letters A new word always begins with an upper case letter.
➤ Â	Press briefly: cursor to the right Press long: switch to diacritics and special characters Press twice: insert line space
➤ Ä	Press briefly: cursor to the right Press long: switch to normal characters Press twice: insert line space
⌫	Clear letters

- 2 Save with ✓.  
- or -  
Cancel with X and quit the menu..

**Note:** For entering a name, Latin characters, certain special characters and numbers are available.

## Starting a recipe

- 1 Set the program selection to any heating function. The 🍷 symbol is displayed.
- 2 Touch the 🍷 symbol. Set the required recipe with the rotary selector.
- 3 Start with ▶.  
Operation begins. Its duration elapses visibly. The settings of the phases appear in the display bar.

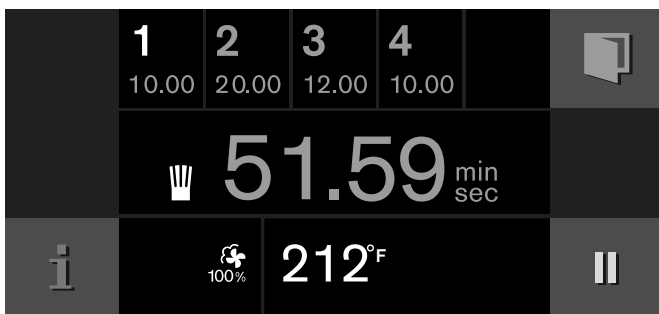

## Notes

- The cooking time does not start counting down until the appliance has reached the set temperature.
- You can use the rotary selector to change the temperature while the recipe is in progress. This does not change the saved recipe.

## Change recipe

You can change the settings of a recorded or programmed recipe.

- 1 Turn the function selector to any heating type. The 🍷 symbol is displayed.
- 2 Touch the 🍷 symbol.
- 3 Use the rotary selector to select the desired recipe.
- 4 Touch the \\_ symbol.
- 5 Use the ➤ symbol to select the desired phase. The programmed heating type, temperature, and cooking time are displayed. You can change the settings with the rotary selector or the function selector.
- 6 Save with ✓.  
- or -  
Cancel with X and exit the menu.

## Deleting a recipe

- 1 Set the function selector to any type of heating. The 🍷 symbol is displayed.
- 2 Touch the 🍷 symbol.
- 3 Use the rotary selector to select the desired recipe.
- 4 Delete the recipe with C.
- 5 Confirm with ✓.

---

## Core temperature probe

---

The core temperature probe enables exact cooking to the spot. It measures the temperature inside the food being cooked. Automatic switching off when the desired core temperature is reached ensures that each cooked food is cooked precisely.

Use the included core temperature probe only. You can purchase one as a spare part from after-sales service or in the online shop.

The core temperature probe is damaged at temperatures above 480°F (250°C). Therefore, only ever use it in your appliance at a maximum temperature setting of 445°F (230°C).

Always remove the core temperature probe from the oven interior after use. Never store it in the oven interior.

After every use, clean the core temperature probe with a moist cloth. Do not wash it in a dishwasher!

---

### **⚠ WARNING**

#### **Risk of electric shock**

Use of a wrong core temperature probe can damage the insulation. Use only the core temperature probe intended for this appliance.

---

---

### **⚠ WARNING**

#### **Risk of burns**

The oven interior and the core temperature probe become very hot. Use oven mitts to plug and unplug the core temperature probe.

---

## Insert the core temperature probe in the food to be cooked

Insert the core temperature probe in the food to be cooked before you place it in the oven interior.

Insert the metal tip at the thickest point in the food you are cooking. Make sure that the end of the tip is approximately in the center. It must not be placed in the fat and must not touch any cookware or bones.



If there are several pieces, insert the core temperature probe in the middle of the thickest piece.

Insert the core temperature probe completely, if possible.

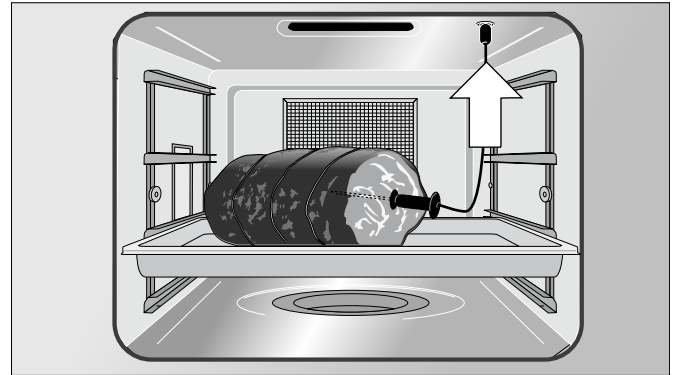
In the case of poultry, make sure that the tip of the core temperature probe is not in the cavity in the center, but in the meat between the belly and upper leg.



## Setting the core temperature

- 1 Insert food into the oven interior with the core temperature probe inserted. Insert the core temperature probe in the socket in the oven interior and close the appliance door. Do not jam the core temperature probe's cable!  and the current core temperature appear in the display.
  - 2 Set the program selection to the required heating function.
  - 3 Set the oven interior temperature with the rotary selector.
  - 4 Touch the  symbol. With the rotary selector, set the required core temperature and confirm it with .
- The set core temperature must be higher than the current core temperature.

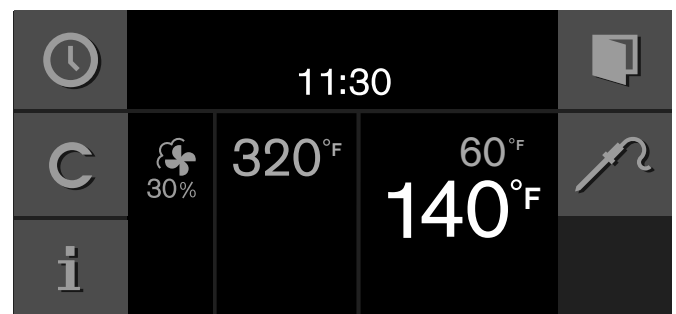



- 5 The appliance heats with the set heating function. The current core temperature is displayed and, under it, the set core temperature. You can change the set core temperature at any time.

A signal sounds when the set core temperature in the food has been reached. The cooking mode is ended automatically. Confirm with  and turn the program selection to 0.

## Notes

- The measurable range is 59 to 210° F (15 to 99°C). Outside the measurable range, "--°F" is displayed for the current core temperature.
- If you leave the food in the cooking compartment for some time after cooking, the core temperature will continue to rise somewhat due to the residual heat in the cooking compartment.
- If at the same time you adjust a programming with the core temperature probe and the cooking time timer, then the programming switches the device off that reaches the specified value first.

### Changing the core temperature set:

Touch the  symbol. Use the rotary selector to change the set core temperature for the food and confirm with .

### Deleting the core temperature set:

Touch the  symbol. Delete the set core temperature with **C**. The appliance continues heating in normal cooking mode.

## Core temperature guidelines

Use chilled food only, not frozen food. The details given in the table are guidelines. Results depend on the quality and composition of the food.

For hygiene reasons, critical foodstuffs such as fish and game should reach a core temperature of 143 - 158° F (62 - 70 °C); for poultry and minced meat this should be as high as 176 - 185° F (80 - 85 °C).

Food	Core temperature guideline
<b>Beef</b>	
Sirloin, tenderloin, entrecôte	
very rare	113 - 117°F (45 - 47 °C)
rare	122 - 126°F (50 - 52 °C)
medium	137 - 140°F (58 - 60 °C)
well-done	158 - 167°F (70 - 75 °C)
Roast beef	176 - 185°F (80 - 85 °C)
<b>Pork</b>	
Pork roast	162 - 176°F (72 - 80 °C)
Pork loin	
medium	149 - 158°F (65 - 70 °C)
well-done	167°F (75 °C)

Food	Core temperature guideline
Meat loaf	185°F (85 °C)
Fillet of pork	149 - 158°F (65 - 70 °C)
<b>Veal</b>	
Veal roast, well-done	167 - 176°F (75 - 80 °C)
Breast of veal, stuffed	167 - 176°F (75 - 80 °C)
Saddle of veal	
medium	137 - 140°F (58 - 60 °C)
well-done	149 - 158°F (65 - 70 °C)
Fillet of veal	
rare	122 - 126°F (50 - 52 °C)
medium	137 - 140°F (58 - 60 °C)
well-done	158 - 167°F (70 - 75 °C)
<b>Game</b>	
Saddle of venison	140 - 157°F (60 - 70 °C)
Leg of venison	158 - 167°F (70 - 75 °C)
Venison loin steaks	149 - 158°F (65 - 70 °C)
Saddle of hare or rabbit	149 - 158°F (65 - 70 °C)
<b>Poultry</b>	
Chicken	185°F (85 °C)
Guinea fowl	167 - 176°F (75 - 80 °C)
Goose, turkey, duck	176 - 185°F (80 - 85 °C)
Duck breast	
medium	131 - 140°F (55 - 60 °C)
well-done	158 - 176°F (70 - 80 °C)
Ostrich steak	140 - 149°F (60 - 65 °C)
<b>Lamb</b>	
Leg of lamb	
medium	140 - 149°F (60 - 65 °C)
well-done	158 - 176°F (70 - 80 °C)

Food	Core temperature guideline
<b>Saddle of lamb</b>	
medium	131 - 140°F (55 - 60 °C)
well-done	149 - 167°F (65 - 75 °C)
<b>Mutton</b>	
<b>Leg of mutton</b>	
medium	158 - 167°F (70 - 75 °C)
well-done	176 - 185°F (80 - 85 °C)
<b>Saddle of mutton</b>	
medium	158 - 167°F (70 - 75 °C)
well-done	176 °F (80 °C)
<b>Fish</b>	
<b>Fillet</b>	
	144 - 149°F (62 - 65 °C)
<b>Whole</b>	
	149°F (65 °C)
<b>Terrine</b>	
	144 - 149°F (62 - 65 °C)
<b>Other provisions</b>	
<b>Bread</b>	
	205°F (96 °C)
<b>Paté</b>	
	162 - 167°F (72 - 75 °C)
<b>Terrine</b>	
	140 - 158°F (60 - 70 °C)
<b>Foie gras</b>	
	113°F (45 °C)

## Child lock

The appliance has a child lock to make sure children cannot operate it inadvertently.

### Notes

- You must set the child lock in the factory setting to "Available" (see section entitled 'Factory setting').
- If there is a power cut while the child lock is activated, it may be deactivated when the power returns.

## Activating the child lock

### Requirement:

Program selector is set to 0.

Touch the  symbol for at least 6 seconds.

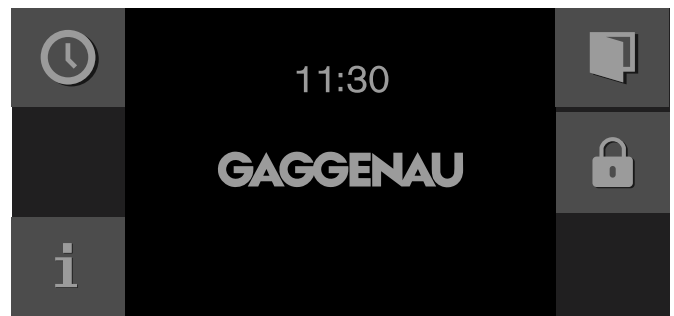

The child lock is activated. The standby screen appears. The  appears at the top of the display.

## Deactivating the child lock

### Requirement:

Program selector is set to 0.

Touch the  symbol for at least 6 seconds.

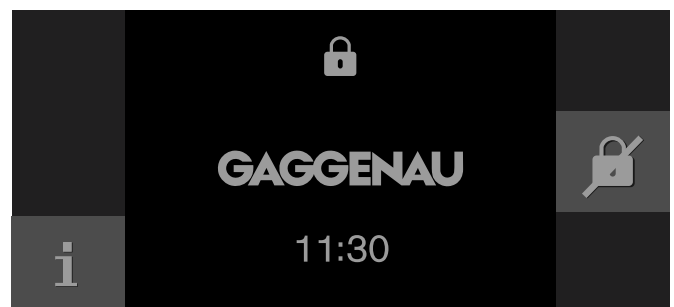

The child lock is deactivated. You can switch on the appliance in the usual manner.













## Factory setting











In the general settings, you can adapt your appliance individually.

- 1 Set the program selector to **S**.
- 2 Select "General setting" with the rotary selector.
- 3 Touch the ✓ symbol.

- 4 Set the required general setting with the rotary selector.
- 5 Touch the ↵ symbol.
- 6 Set the general setting with the rotary selector.
- 7 Save with ✓ or cancel with ✕ and quit the current general setting.
- 8 Turn the program selector to **0** to quit the general setting menu.

Changes are saved.

	Basic setting	Possible settings	Explanation
	Brightness	Stages 1, 2, 3, 4, 5*, 6, 7, 8	Setting display brightness
	Standby screen	On*/Off - Clock - Clock + GAGGENAU logo* - Date - Date + GAGGENAU logo - Clock + date - Clock + date + GAGGENAU logo	Appearance of the standby screen. Off: no display. Use this setting to reduce the standby consumption of your appliance. On: several displays can be set, confirm "On" with ✓ and choose the desired display with the rotary selector. The selection is displayed.
	Display screen	Minimized*/Standard	When 'Minimized' is set, only the most important details are displayed after a short time.
	Touchpad color	Gray*/White	Select the color of symbols on the touchpads
	Touchpad tone	Tone 1*/Tone 2/Off	Select the signal tone when touching a touchpad
	Touchpad volume	Levels 1, 2, 3, 4, 5*, 6, 7, 8	Sets the volume of the touchpad tone
	Preheating signal	On*/Off	The signal tone sounds when the required temperature is reached during preheating.
	Signal volume	Levels 1, 2, 3, 4, 5*, 6, 7, 8	Sets the volume of the signal tone
	Water hardness	1-18	Check mains water with the included carbon hardness test. Set the measured water hardness.
	Calibration	Calibrating the appliance	Setting the boiling point
	Time format	AM/PM / 24 h*	Time display in 24 or 12-hour format
	Time	Current time	Setting the time

	Daylight savings	Manual*/Automatic	Automatic time changeover when changing daylight savings time. If automatic: setting of the month, day and week when the time is to be changed. To be set separately for summer and winter time.
	Date format	D.M.Y* D/M/Y M/D/Y	Setting the date format
	Date	Current date	Setting the date. Switch between the year/month/day with the > symbol.
	Temperature format	°C*/°F	Set the temperature unit
	Language	German* / French / Italian / Spanish / Portuguese / Dutch / Danish / Swedish / Norwegian / Finnish / Greek / Turkish / Russian / Polish / Czech / Slovenian / Slovakian / Arabic / Hebrew / Japanese / Korean / Thai / Chinese / English US / English	Select language for the text display <b>Note:</b> When the language is changed, the system is restarted; this procedure takes a few seconds. Then the General settings menu is closed.
	Factory settings	Restore appliance to factory settings	Confirm the question "Delete all individual settings and restore appliance to factory settings?" with ✓ or cancel with ✕. <b>Note:</b> When restoring factory settings, the personal recipes are also deleted. After restoring the factory settings, you will see the "Initial settings" menu.
	Demo mode	On/Off*	For presentation purposes only. The appliance does not heat in the demo mode, but all other functions are available. The "Off" setting must be activated for normal operation. The setting is only possible in the first three minutes after connecting the appliance.
	Sabbath mode	Not Available* / Available	Available: Sabbath mode can be set; see the section entitled 'Sabbath mode'.
	Door lock	Off*/On	The door lock prevents unintentional opening of the appliance door. When "On" is set, you must touch the  symbol for several seconds before the door opens.
	Child lock	Not Available* / Available	Available: the child lock can be activated (see section entitled 'Child lock').

\* Factory settings

---

## Cleaning and maintenance

---

If taken care of and cleaned conscientiously, your appliance will stay beautiful and intact for a long time. Here we explain how to take care of and clean your appliance correctly.

---

### WARNING

---

#### Risk of electrical shock

Moisture entering the appliance can cause an electrical shock. Don't use a high-pressure cleaner or steam cleaner.

---

---

### WARNING

---

#### Risk of burns

- To avoid risk of injury, never touch the inside surfaces of the oven interior or heating elements. These surfaces are extremely hot after use. Always allow the appliance to cool down before touching or cleaning the interior.
  - Always turn off the interior light before cleaning the oven to allow the bulbs to cool down. The bulbs can become very hot when switched on. Keep the light off while cleaning the oven.
  - Keep children away.
- 

---

### WARNING

---

#### Risk of injury

Scratched glass in the appliance door can burst. Do not use any glass scrapers or strong or abrasive cleaning agents.

---

---

### WARNING

---

Do not clean the appliance while it is still hot. Some cleaners produce noxious fumes when applied to a hot surface. Wet clothes and sponges can cause burns from steam.

---

## Cleaning agents

Pay attention to the information in the table to ensure that the various surfaces are not damaged by incorrect cleaning agents.

Do not use any

- sharp or abrasive cleaning agents
- metal or glass scrapers to clean the glass on the appliance door.
- metal or glass scrapers to clean the door seal.
- hard abrasive pads or cleaning sponges.

Thoroughly rinse out new sponge cloths before use.

---

Area	Cleaning agent
Door panes	Glass cleaner: clean with a dishcloth. Do not use any glass scrapers for cleaning.
Display	Wipe off with a microfiber cloth and a slightly moistened cloth. Do not wipe it off wet.
Stainless steel	Hot soapy water: clean with a dishcloth and dry with a soft cloth. Remove scale, grease, starch and protein stains immediately. Corrosion can form under such stains. Special stainless steel cleaners are available from after-sales service or specialist dealers.
Aluminum	Clean with a mild window cleaning agent. Using a window cleaning cloth or a lint-free microfiber cloth, wipe horizontally over surfaces without applying pressure.
Stainless steel or enamel oven interior	Hot soapy water: clean with a dishcloth and dry with a soft cloth.

Do not use oven spray or other aggressive oven cleaners or abrasive agents. Scourers, rough sponges and pot cleaners are also unsuitable. They scratch the surface.

For regular care, use oven interior care agents in compliance with the manufacturer's specifications (order number 667027 from after-sales service or in the online shop).

---

### CAUTION

---

Do not spray cleaner into the ventilation flap on the top of the oven interior!

Cleaner residues will create stains when heated up. Before drying the oven interior, thoroughly remove cleaner or care agent residues with clear water.

---

Always dry the oven interior after cleaning (see Section entitled *Drying program*).

Area	Cleaning agent
Extremely soiled stainless steel or enamel oven interior	Oven cleaner gel (order number 463582 from after-sales service or in the online shop). <b>Please note:</b> <ul style="list-style-type: none"> <li>● Must not penetrate into seals on the door, the lamp or the evaporator tray</li> <li>● Allow it to act for no more than 12 hours.</li> <li>● Do not use on hot surfaces.</li> <li>● Rinse thoroughly with water.</li> <li>● Pay attention to manufacturers' specifications.</li> </ul>
Glass cover of oven interior lamp	Hot soapy water: Clean with a dishcloth.
Grease filter	Dishwasher
Water tank	Hot soapy water. Do not clean in a dishwasher. Dry the seal in the cover well. Allow to dry with the cover open.
Tank slot	Rub dry after operation.
Door seal	Hot soapy water: clean with a dishcloth.
Do not remove!	Do not scrape. Do not use any metal or glass scrapers for cleaning.
Meat probe	Wipe off with a moist cloth. Do not clean in a dishwasher.
Cooking receptacle, rack	Dishwasher or hot soapy solution. Soak baked-in grime and clean with a brush.
Slide-in racks	Dishwasher or hot soapy solution. See Section entitled <i>Removing slide-in racks</i>

### Cleaning sponge

The included cleaning sponge is highly absorbent. Only use the cleaning sponge to remove remaining water from the evaporator tray and to clean the oven interior.

Thoroughly wash the cleaning sponge before using it for the first time. You can wash the cleaning sponge along with clothes in the washing machine.

### Microfiber cloth



The honeycomb microfiber cloth is particularly suitable for cleaning sensitive surfaces such as glass, glass ceramic, stainless steel or aluminum (product no. 00460770, also available from our online online shop). It removes liquid and greasy deposits in one go.

## Cleaning aid



The cleaning aid loosens stubborn grime from the oven interior and makes cleaning easy.

The cleaning aid consists of the steps of once cleaning and twice rinsing.

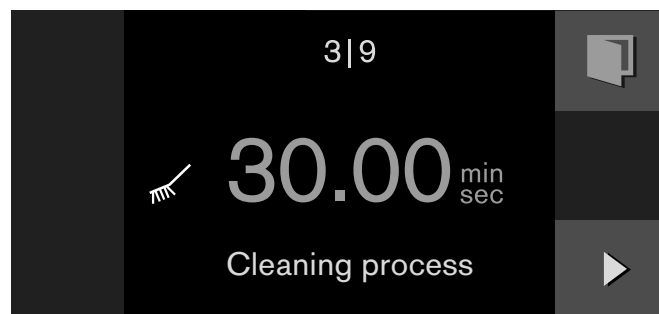

### Starting the cleaning aid

- 1 Set the function selector to **S**.
- 2 The  symbol is displayed. Confirm with .
- 3 Remove accessories and grease filters from the oven interior. Remove slide-in racks from the oven interior (see section entitled **Removing slide-in racks**). Wipe out the oven interior with detergent.
- 4 Fill the water tank with cold water up to the "max" mark and slide it into the tank slot. Close the appliance door.
- 5 The cleaning time of 30 minutes appears. Start with . The cleaning time elapses on the display. The lamp in the oven interior stays off.

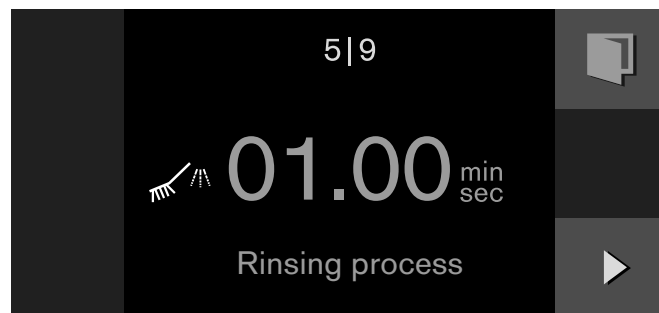

- 6 A signal sounds after 30 minutes. A message appears in the display.
- 7 Wipe out the oven interior. Remove cleaner residues. Fill the water tank with fresh water. Confirm with .
- 8 The first rinsing operation appears. Start with . The appliance rinses. The rinsing time elapses on the display.



- 9 A signal sounds after 1 minute. Empty the evaporator tray with the cleaning sponge. Confirm with .
- 10 The second rinsing operation appears. Start with . The appliance rinses. The rinsing time elapses on the display.



A signal sounds after 1 minute. Empty the evaporator tray with the cleaning sponge. Empty the water tank and allow it to dry with the cover open. Wipe the oven interior dry with a soft cloth and dry it completely with the drying program.

#### Notes

- Always allow the cleaning aid to run fully. It cannot be prematurely.
- Remove cleaning agent residue thoroughly from the oven interior before cooking.
- If the cleaning aid has been canceled due to a power outage, you must restart the cleaning aid before the next use to remove cleaning agent residue from the oven interior.

## Drying program



With the drying program, you can dry the oven interior after cleaning or after steaming.

The drying program takes 20 minutes.

### ⚠ CAUTION

Do not dry the water tank in the hot oven interior. This would damage the water tank.

#### Starting the drying program

- 1 Remove the water tank. Remove accessories from the oven interior. Empty the evaporator tray with the cleaning sponge. Wipe out the oven interior. Thoroughly remove residues of cleaner. Close the appliance door.
- 2 Set the function selector to **S**. Select the drying program with the rotary selector.
- 3 The  symbol is displayed. Confirm with .
- 4 The drying time of 20 minutes appears. Start with . The drying time elapses on the display. The lamp in the oven interior stays off.

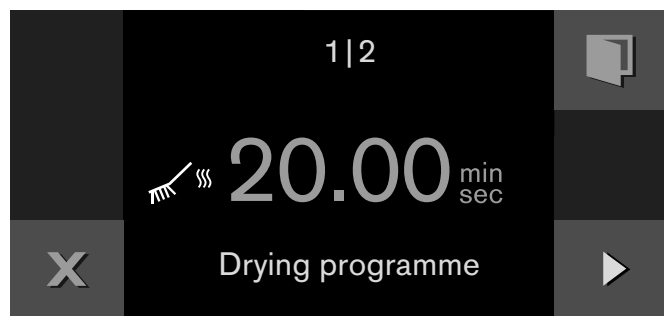

- 5 A signal sounds after 20 minutes. A message appears in the display. Confirm with .

The drying program has ended. Allow the appliance to cool down. Then polish the oven interior and the pane with a soft cloth.

## Descaling program

Your appliance must be descaled at regular intervals for it to remain operable. A reminder appears in the display.

The descaling program consists of the steps of descaling and twice rinsing.

#### Descaler

For descaling, use only the liquid descaler recommended by after-sales service (order No. 311138 from after-sales service or in the online shop). Other descaling agents can cause damage to the appliance.





### ⚠ CAUTION

#### Surface damage

Wipe off descaler immediately with water if it reaches the door seal, the front or other sensitive surfaces.

#### Starting the descaling program

The oven interior must have cooled down completely.

- 1 Mix 300 ml (about 0.6 pints) of water and 60 ml (about 0.13 pints) of liquid descaler to form a descaling solution.
- 2 Set the function selector to **S**. Select the descaling program with the rotary selector.
- 3 The  symbol is displayed. Confirm with .
- 4 Fill the water tank with the descaling solution and slide it into the tank slot. Close the appliance door. Confirm with .
- 5 The descaling time of 30 minutes appears. Start with . The descaling time elapses on the display. The lamp in the oven interior stays off.

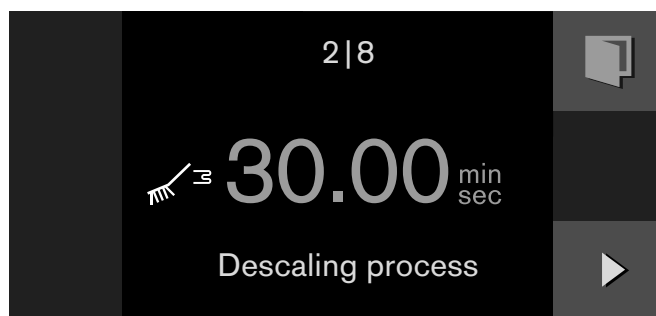

- 6 Nach 30 Minuten ertönt ein Signal. Eine Meldung erscheint im Display.
- 7 Empty the evaporator tray with the cleaning sponge. Fill the water tank with cold water. Confirm with .

- 8 The first rinsing operation appears. Start with ►. The appliance rinses. The rinsing time elapses on the display.

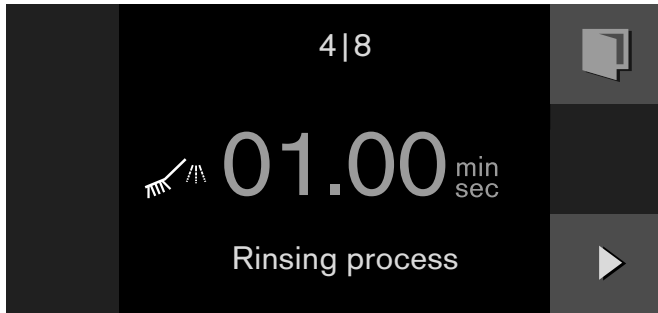

- 9 A signal sounds after 1 minute. Empty the evaporator tray with the cleaning sponge. Confirm with ✓.
- 10 The second rinsing operation appears. Start with ►. The appliance rinses. The rinsing time elapses on the display.

A signal sounds after 1 minute. The descaling program has ended.

Empty the evaporator tray with the cleaning sponge. Empty the water tank and allow it to dry with the cover open. Wipe the oven interior dry with a soft cloth and dry it completely with the drying program.

Then clear the descaling reminder from the display.

#### Clearing the descaling reminder

- 1 Set the function selector to **S**. Select “ Delete descaling reminder” with the rotary selector. Confirm with ✓.
- 2 A message appears. Confirm with ✓.

#### Notes

- The descaling programme must always run completely and can not be cancelled.
- Before cooking, remove any descaler residue from the cooking compartment.
- If the descaling programme was cancelled due to a power cut, it must be restarted before using the oven again in order to remove any descaler residues from the appliance.

## Removing slide-in racks

You can remove the slide-in racks for cleaning.

### Removing slide-in racks

- 1 Place a dishcloth in the oven interior to protect the stainless steel against scratches.
- 2 Undo the knurled nuts (Figure A).
- 3 Pull away the slide-in racks slightly sideward from the screw and pull it out toward you (Figure B).

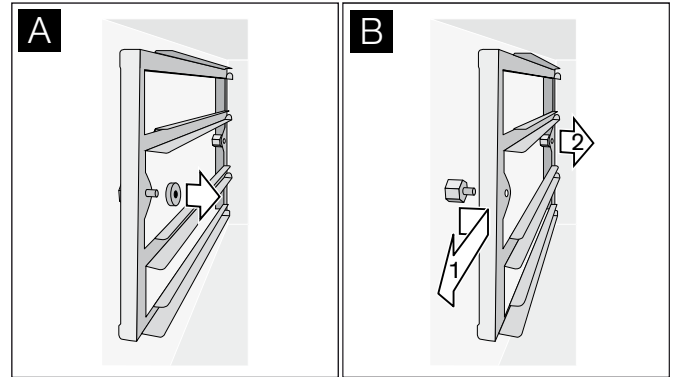

You can clean the slide-in racks in a dishwasher.

### Hooking in slide-in racks

- 1 Fit slide-in racks the right way round: they bottom at the back.
- 2 Push the slide-in racks onto the bolt at the rear and then hook them in at the front.
- 3 Tighten the knurled nuts.

**Note:** If you should lose a knurled nut, you can reorder it as a spare part from our after-sales service. Using knurled nuts other than the original ones will cause corrosion in the oven interior.



## Troubleshooting

You can often easily eliminate problems that may occur on your own. Before calling customer service, take into account the following information.

### WARNING

#### Risk of electric shock

Improper repairs are dangerous. Only an authorized servicer may perform repairs and may replace damaged plug and connections. Remove the power plug or turn off the circuit breaker or fuse in the fuse box if the appliance is damaged or not working. Call Customer Service.

Disruption	Possible cause	Solution
Appliance not working, no display	Plug not inserted	Connect the appliance to the electricity mains
	Power failure	Check whether other kitchen appliances are working
	Fuse defective	Check in the fuse box whether the fuse for the appliance is in working order
	Operating error	Switch off the fuse for the appliance in the fuse box and switch it on again after about 10 seconds
Appliance cannot be started	Appliance door is not quite closed	Close appliance door
Appliance is not working, display is not responding.  appears in the display.	Child lock activated	Deactivate child lock (see section entitled 'Child lock')
Appliance switches off automatically	Safety deactivation: the appliance has not been operated for longer than 12 hours	Confirm the message with  , switch off the appliance and set it again.
Appliance does not heat up,  appears in the display	Appliance is in the demo mode	Deactivate demo mode in the basic settings
Appliance cannot be started, and a message appears on the display	Water tank is empty	Fill water tank
No steam visible	Steam is not visible above 212° F (100° C)	This is normal
Extreme amounts of steam emerging at the top of the door	Appliance is calibrating the boiling point or is preheating or the mode has been changed	This is normal
	Boiling point has not yet been adjusted	Adjust the boiling point
Extreme amounts of steam emerging at the side of the door	Door seal soiled or loose	Clean the door seal and insert it in the groove
There is a 'plop' noise during cooking	Stress expansion in the event of a large temperature difference	This is normal
Appliance does not steam properly any more	Appliance is clogged with scale	Start the descaling program
Error message "Exxx"		If an error message appears, turn the program selection to 0; if the display goes off, it was a one-time problem. If the problem occurs repeatedly or if the display stops, please contact after-sales service and inform them of the error code.

## Power cut

Your appliance can bridge a power cut of a few seconds. Operation continues.

If the power cut was for a longer period and the appliance was in operation, a message appears in the display. Operation is interrupted.

Set the function selector to **0**, then the appliance can be operated again as usual.

## Demo mode

The demo mode is activated if the  symbol appears in the display. The appliance does not heat up.

Briefly disconnect the appliance from the mains (switch off the domestic fuse or the circuit-breaker in the fuse box). Then deactivate the demo mode within 3 minutes in the factory setting (see section entitled 'Factory setting').

## Replacing the oven interior lamp

For technical reasons, the lamp cover is not detachable. Only Gaggenau after-sales service may replace the lamp.

---

### CAUTION

Do not detach the lamp cover. This would damage the seal.

---

The lamp cover in the oven must be replaced if it is damaged. You can obtain covers from after-sales service. Always specify the E number and the FD number of your appliance.

---

## Customer service

---

If your appliance needs repairs, our customer service is there for you. We work hard to help solve problems quickly and without unnecessary service calls, getting your appliance back up and running correctly in the least amount of time possible.

When you call, please indicate the product number (E-Nr.) and serial number (FD-Nr.) so that we can support you in a qualified manner. You will find the type plate with these numbers on the bottom of the appliance. To avoid having to search for a long time when you need it, you can enter your appliance data and the customer support telephone number here.

---

E-Nr.

FD-Nr.

---

Customer Service 

---

Please read the use and care instructions provided with your appliance. Failure to do so may result in an error in using the appliance. This could result in a service call that instead of fixing a mechanical issue is only needed for customer education. Such calls are not covered by the appliance warranty.

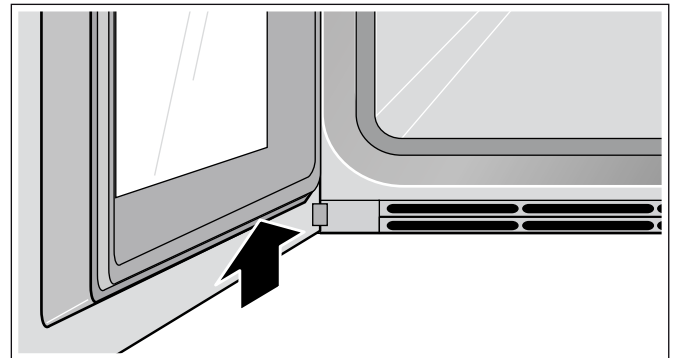

Please find the contact data of all countries in the enclosed customer service list.

### To book an engineer visit and product advice

**USA**            877 442 4436  
toll-free

**CANADA**      877 442 4436  
toll-free

You can rely on the manufacturer's expertise. Rest assured that the repair will be handled by trained service technicians who have the original replacement parts for your appliance.

## Tables and tips

### Notes

- The cooking times specified are intended as a guide. The actual cooking time depends on the quality and temperature of the food before cooking, the weight and thickness of the food to be cooked.
- Always preheat the appliance. Here's how to get the best cooking results.  
The cooking times specified refer to a pre-heated appliance. Cook the food approx. 5 minutes longer if the appliance is not pre-heated.
- The specifications refer to average quantities for four people. If you would like to prepare more, you should calculate a longer cooking time.
- Use the cookware specified. If you use other cookware, cooking times may be longer or shorter.
- Begin with the shortest time specified if you have not made a dish before. If necessary, you can always cook the food longer.
- Make sure to open the cooking compartment door of the pre-heated appliance only briefly and to fill the appliance quickly.
- If you are using only one cooking container, insert it on the second level from the bottom.
- If you use the perforated cooking insert or the grid without additional cookware, always insert the non-perforated cooking insert in the first level from the bottom in order to avoid soiling the bottom of the cooking compartment and steamer tray more than necessary.
- When steaming, defrosting, proofing dough, and reheating, you can use up to three slide-in levels at the same time (slide-in levels 2, 3, and 4 from the bottom). This way there is no taste transfer. This is how fish, vegetables, and dessert can be prepared at the same time. The cooking times specified may be longer with a large quantity of food.
- Baking can only be done on one level; for this, use the second level from the bottom.
- Do not allow the food to touch the cooking compartment, grease filter or back wall of the oven.
- The steam baking oven door must close securely. Always keep the sealing surfaces clean.
- Do not crowd the grid and containers too tightly. This guarantees optimal steam circulation.
- Leave the grease filter in the appliance at all times.
- If you want to prepare dishes in steam and the appliance is hotter than 100°C (e.g. because something was baked in it previously), let the appliance cool off before steaming. Otherwise the dishes will dry out due to the excessive heat.

## Vegetables

- Vegetables are prepared more gently in steam than in boiling water. Their taste, color and consistency are preserved better. Vitamins and ingredients that are soluble in water are hardly washed out. As the steam oven operates without pressure at only 212° F (100°C), foods are prepared considerably more gently than in a pressure cooker, for example.
- All data refers to 1 kg (about 2 lb) of cleaned vegetables.
- Use the perforated cooking insert to steam vegetables, sliding it into the second level from below. Slide the unperforated cooking insert under it. This prevents extreme soiling of the oven interior. You can use collect the vegetable juice and use it as the basis for a sauce or a vegetable broth.
- Blanch vegetables for up to four minutes in the preheated appliance. If vegetables or fruits are not served straight away, quench them in icy water to prevent simmering in the residual heat.

Foodstuff	Cooking receptacle	Temperature in ° F (°C)	Humidity in %	Cooking time in min.	Remarks
Artichokes, large	Perforated	212 (100)	100	25 - 35	
Artichokes, small	Perforated	212 (100)	100	15 - 20	
Cauliflower, whole	Perforated	212 (100)	100	20 - 25	
Cauliflower, in florets	Perforated	212 (100)	100	15 - 20	
Beans, green	Perforated	212 (100)	100	25 - 30	
Broccoli, in florets	Perforated	212 (100)	100	10 - 15	
Fennel, in strips	Perforated	212 (100)	100	10 - 15	

Foodstuff	Cooking receptacle	Temperature in ° F (° C)	Humidity in %	Cooking time in min.	Remarks
Vegetable terrine	Perforated/ rack	212 (100)	100	50 - 60	In a terrine form
Carrots, in slices	Perforated	212 (100)	100	10 - 15	
Potatoes, peeled and quartered	Perforated	212 (100)	100	20 - 35	
Kohlrabi, in slices	Perforated	212 (100)	100	15 - 25	
Leek, in slices	Perforated	212 (100)	100	5 - 10	
Bell pepper, filled	Unperforated	355 - 390 (180 - 200)	80/100	15 - 20	If there is a meat filling, brown the filling beforehand.
Jacket potatoes (about 50 g (approx. 1.8 oz) each)	Perforated	212 (100)	100	25 - 30	
Jacket potatoes (about 100 g (approx. 3.5 oz) each)	Perforated	212 (100)	100	40 - 45	
Brussels sprouts	Perforated	212 (100)	100	15 - 20	
Asparagus, green	Perforated	212 (100)	100	10 - 15	
Asparagus, white	Perforated	212 (100)	100	18 - 25	
Spinach	Perforated	212 (100)	100	4	
Tomatoes, skinned	Perforated	212 (100)	100	3 - 4	Cut into tomatoes and quench them with icy water after steaming.
Zucchini, stuffed	Perforated	320 - 355 (160 - 180)	80/100	15 - 35	If there is a meat filling, brown the filling beforehand.
Sugar snaps	Perforated	212 (100)	100	10 - 15	

## Fish

- Steaming is a fat-free way of cooking food, with which the fish does not dry out.
- Fish should (for hygienic reasons) have a core temperature of at least 143 - 149° F (62 - 65° C) after cooking. This is also the ideal cooking point.
- Only salt the fish after cooking. Thus the natural aroma is retained and less water is removed from the fish.
- If you are using the perforated cooking container: you can grease the container if the fish sticks too much.
- Insert the unperforated cooking insert into the first level from the bottom to prevent soiling the cooking compartment with fish juices.
- For fillets with skin: if you place the fish skin-side up, the structure and aroma will be retained better.

Food	Cooking container	Temperature in ° F (° C)	Humidity in %	Cooking time in min.	Observations
Gilthead bream, whole (500 g / 1 lb 2 oz)	unperforated	195 - 212 (90 - 100)	100	18 - 20	Can be cooked in swimming position if you set it on half a potato.
Fish dumplings (20 - 40 g / 1 - 1½ oz apiece)	unperforated	195 - 212 (90 - 100)	100	4 - 8	Line the unperforated cooking container with greaseproof paper.
Lobster, cooked, removed from the shell, reheating	perforated	160 - 175 (70 - 80)	100	10 - 12	
Carp, blue, whole (1.5 kg / 3½ lb)	unperforated	195 - 212 (90 - 100)	100	35 - 45	in broth
Salmon filet (150 g / 5 oz)	perforated	195 - 212 (90 - 100)	100	10 - 12	
Salmon, whole (2.5 kg / 5½ lb)	perforated	212 (100)	100	65 - 75	
Blue mussels (1.5 kg / 3½ lb)	perforated	212 (100)	100	6 - 8	The blue mussels are cooked as soon as their shells open up.

Food	Cooking container	Temperature in °F (°C)	Humidity in %	Cooking time in min.	Observations
Atlantic salmon, whole (800 g / 1 lb 12 oz)	perforated	195 - 212 (90 - 100)	100	18 - 20	
Monkfish filet (300 g / 11 oz each)	Glass pan/wire rack	355 - 390 (180 - 200)	100	8 - 10	In stock
Sea bass, whole (400 g / 14 oz)	perforated	195 - 212 (90 - 100)	100	12 - 18	

## Fish – low-temperature steaming

- When steaming between 160 and 190° F (70 and 90°C) overcooked and the fish does not fall apart so easily. This is especially an advantage for delicate fish.
- The details for the various types of fish refer to fillets.
- Insert the unperforated cooking insert into the first level from the bottom to prevent soiling the cooking compartment with fish juices.
- Serve on a pre-warmed dish.

Food	Cooking container	Temperature in °F (°C)	Humidity in %	Cooking time in min.	Observations
Oysters (10)	unperforated	180 - 190 (80 - 90)	100	2 - 5	in broth
Tilapia (150 g / 5 oz)	perforated	180 - 190 (80 - 90)	100	10 - 12	
Gilthead bream (200 g / 7 oz)	perforated	180 - 190 (80 - 90)	100	12 - 15	
Fish fillet (200 - 300 g / 7 - 11 oz)	perforated	180 - 190 (80 - 90)	100	12 - 15	
Fish terrine	Wire rack	160 - 180 (70 - 80)	100	50 - 90	In a terrine mold For precise cooking point control, use the core temperature probe (see "core temperature probe" chapter).
Trout, whole (250 g / 9 oz)	perforated	180 - 190 (80 - 90)	100	12 - 15	
Halibut (300 g / 11 oz)	perforated	180 - 190 (80 - 90)	100	12 - 15	
Scallops (15 - 30 g / ½ - 1 oz)	unperforated	180 - 190 (80 - 90)	100	4 - 8	The more the scallops weigh, the longer the chosen cooking time should be.
Cod (250 g / 9 oz)	perforated	180 - 190 (80 - 90)	100	10 - 12	
Red snapper (200 g / 7 oz)	perforated	180 - 190 (80 - 90)	100	12 - 15	
Redfish (120 g / 4 oz)	perforated	180 - 190 (80 - 90)	100	10 - 12	
Monkfish (200 g / 7 oz)	perforated	180 - 190 (80 - 90)	100	10 - 15	
Sole rolls, stuffed (150 g / 5 oz apiece)	perforated	180 - 190 (80 - 90)	100	12 - 15	
Turbot (300 g / 11 oz)	perforated	180 - 190 (80 - 90)	100	12 - 15	
Sea bass (150 g / 5 oz)	perforated	180 - 190 (80 - 90)	100	10 - 12	
Pike-perch (250 g / 9 oz)	perforated	180 - 190 (80 - 90)	100	12 - 15	

## Meat – cooking at higher temperatures

- The combination of steam and hot air is the optimal cooking process for many types of meat. The cooking compartment is hermetically sealed in this mode, the moisture prevents the meat from drying out as in conventional hot air. Thanks to the variable humidity control, the optimal climate can be achieved for every type of food.
- The cooking times specified should be regarded as guidelines and depend heavily on the initial temperature of the food and the length of time roasted. For better results, use the core temperature probe. For notes and optimal target temperatures, see the "core temperature probe" chapter.
- Take the meat out of the refrigerator 1 hour before preparation.
- If you are using the perforated cooking inserts or the wire rack, insert an unperforated cooking container underneath. Put a little water in the unperforated cooking insert to prevent burning. In addition, you can add vegetables, wine, spices and herbs in order to create a tasty sauce base.
- If you would like to cook the meat so it is medium or rare: open the door 40° F (5° C) before the desired core temperature is reached and wait until the target temperature has been reached. This way you prevent overcooking and you give the meat the necessary time to rest.
- Meat's time to rest: Let the meat rest on a wire rack for 5 min. after cooking. This way, the meat can "relax." The circulation of the meat juice slows down and there is less loss of juice when cutting into the meat.

Foodstuff	Cooking receptacle	Temperature in °F (°C)	Humidity in %	Cooking time in min.	Remarks
Entrecote, browned, medium-rare (350 g/12 oz each)	Unperforated	340 - 355 (170 - 180)	0/30	10 - 20	
Filet, browned, medium-rare, in puff pastry (600 g/21 oz)	Unperforated	375 - 390 (190 - 200)	80/100	25 - 40	Line the cooking receptacle with baking paper
Back of veal, browned, medium-rare (1 kg/2 lb)	Unperforated	320 - 355 (160 - 180)	30/60	20 - 30	30 % humidity is sufficient when liquid is added to the unperforated cooking receptacle.
Smoked pork chops, cooked, in slices	Unperforated	210 (100)	100	15 - 20	
Roast pork with crust, well-done (1.5 kg/3.5 lb)	Rack	1) 250 (120)	100	30	Cut into the crust crosswise before cooking. Use the core temperature probe: in the second cooking step, you should achieve a core temperature of about 150 °F (65 °C) to cook the meat in the third step up to a core temperature of 165 - 175 °F (75 - 80 °C).
		2) 340 - 355 (170 - 180)	60	30 - 35	
		3) 430 (220)	0	10 - 15	
Leg of lamb, browned, medium-rare (1.5 kg/3.5 lb)	Unperforated	340 - 355 (170 - 180)	30/60	60 - 80	
Back of venison, browned, medium-rare (500 g/ 18 oz each)	Unperforated	320 - 355 (160 - 180)	0/30	12 - 18	
Beef roast, well-done (1.5 kg /3.5 lb)	Rack	1) 410 - 445 (210 - 230)	100	15 - 20	30 % humidity is sufficient when liquid is added to the unperforated cooking receptacle.
		2) 285 - 320 (140 - 160)	30/60	60 - 90	
Roast beef, browned, medium-rare (1 kg/2 lb)	Unperforated	320 - 355 (160 - 180)	0/30	40 - 60	
Roast pork (neck or shoulder), well-done (1.5 kg /3.5 lb)	Rack	1) 430 - 445 (220 - 230)	100	20	30 % humidity is sufficient when liquid is added to the unperforated cooking receptacle.
		2) 320 - 340 (160 - 170)	30/60	60 - 90	
Heating up (boiled) sausage	Unperforated	185 - 195 (85 - 90)	100	10 - 20	e.g. Bavarian veal sausage ('Weisswurst') or 'Lyoner' pork sausage



## Meat/poultry – low-temperature cooking

- Meat browned crisp needs to rest for a longer period at low temperature. This way, the meat gets evenly pink and extremely juicy but for a very thin crusty edge. Here, neither turning nor basting are required.
- The cooking times specified should be regarded as guidelines and depend heavily on the initial temperature of the food and the length of time roasted. For better results, use the core temperature probe. For notes and optimal target temperatures, see the "core temperature probe" chapter.
- Take the meat out of the refrigerator 1 hour before preparation.
- For hygienic reasons, brown the meat on all sides in the pan briefly and over high heat before cooking. This way, the meat has a crust that prevents the juices from escaping and provides a typical roast flavor.
- Season carefully: the slow resting of the meat intensifies all flavors.
- With game and horse meat, the flavor is stronger with low-temperature cooking than with a classic preparation.
- Use the "Low-temperature cooking" mode  $\curvearrowright$ . Any steam escaping from the food therefore remains in the cooking compartment and prevents the food from drying out.
- Please note that you cannot reach any core temperatures above the cooking compartment temperature. The rule of thumb is: the set cooking compartment temperature should be 50 - 60°F (10-15 °C) above the desired core temperature.
- Toward the end of the cooking time, you can reduce the temperature to 140°F (60 °C). This way, you can extend the cooking time (e.g. if your guests arrive late). If you want to stop the cooking process, the cooking compartment temperature may not be higher than the desired core temperature. Thus, large pieces can remain in the cooking compartment for 1 - 1.5 hours, small pieces for 30-45 minutes.
- Serve on a pre-warmed dish.

Food	Cooking container	Temperature in °F (°C)	Type of heating	Cooking time in min.	Observations
Duck breast, medium rare (350 g / 12 oz)	unperforated	160 - 175 (70 - 80)	$\curvearrowright$	40 - 60	Skin side can be browned crisp in the pan after cooking.
Entrecôte, medium rare (350 g / 12 oz)	unperforated	160 - 175 (70 - 80)	$\curvearrowright$	40 - 70	
Leg of lamb, boned, trussed, medium (1.5 kg / 3½ lb)	unperforated	160 - 175 (70 - 80)	$\curvearrowright$	180 - 240	Before cooking, turn in oil with garlic and herbs.
Beef steaks, medium rare (175 g / 6 oz)	unperforated	160 - 175 (70 - 80)	$\curvearrowright$	30 - 60	
Sirloin, medium rare (1 - 1.5 kg / 2 lb 4 oz - 3½ lb)	unperforated	160 - 175 (70 - 80)	$\curvearrowright$	150 - 210	Cut in slices and serve with Béchamel sauce.
Pork medallions, well-done (70 g / 2½ oz apiece)	unperforated	175 (80)	$\curvearrowright$	50 - 70	

## Poultry

- The humidity for combination operation prevents the drying out, which is essential with poultry. At the same time, thanks to the high temperature, the surface gets crispy and brown. The hot steam has twice as much ability to transfer heat as conventional hot air and reaches all parts of the food. Therefore, a chicken is browned evenly and gets crispy, yet the breast meat remains tender and juicy.
- The cooking times specified should be regarded as guidelines and depend heavily on the initial temperature of the food and the food cooked. For better results, use the core temperature sensor. Do not place it in the middle (hollow space), but rather between the belly and upper thigh. For notes and optimal target temperatures, see the "core temperature probe" chapter.
- If you season poultry primarily with spices and with little or no oil, the skin gets crispier.

Foodstuff	Cooking receptacle	Temperature in °F (°C)	Humidity in %	Cooking time in min.	Remarks
Duck, whole (3 kg/ 6.6 lb)	Unperforated	1) 300 - 320 (150 - 160) 2) 430 (220)	60 0	80 - 90 20 - 30	Start cooking with the breast pointing down. Turn the duck round after half of the cooking time. In this way, the sensitive breast meat will not dry out so much.
Duck breast, browned, medium-rare (350 g/ 12 oz each)	Unperforated	320 - 355 (160 - 180)	0	12 - 18	
Chicken, whole (1.5 kg /3.3. lb)	Rack	340 - 355 (170 - 180)	60	50 - 60	
Chicken breast, stuffed, steamed (200 g/7 oz each)	Perforated	212 (100)	100	10 - 15	
Chicken leg (350 g/ 12 oz each)	Rack	340 - 355 (170 - 180)	30/60	40 - 45	
Turkey breast fillet, steamed (300 g/11 oz each)	Perforated	212 (100)	100	12 - 15	
Spring chicken, quail, pigeon (300 g/11 oz each)	Perforated	212 (100)	100	25 - 30	
Spring chicken, quail, pigeon (300 g /11 oz each)	Perforated	355 - 390 (180 - 200)	60/80	12 - 16	

## Side dishes

Also note the instructions on the packaging.

Food	Cooking container	Temperature in °F (°C)	Humidity in %	Cooking time in min.	Observations
Basmati rice (250 g + 500 ml of water / 9 oz + 1 pint of water)	unperforated	212 (100)	100	15 - 20	
Couscous (250 g + 250 ml of water / 9 oz + 1/2 pint of water)	unperforated	212 (100)	100	5 - 10	
Dumplings (90 g / 3 oz apiece)	perforated/ unperforated	205 - 212 (95 - 100)	100	20 - 25	
Long-grain rice (250 g + 500 ml of water / 9 oz + 1 pint of water)	unperforated	212 (100)	100	20 - 25	
Brown rice (250 g + 375 ml of water / 9 oz + 0.8 pint of water)	unperforated	212 (100)	100	25 - 35	

Food	Cooking container	Temperature in °F (°C)	Humidity in %	Cooking time in min.	Observations
Lentils (250 g + 500 ml of water/ 9 oz + 1 pint of water)	unperforated	212 (100)	100	25 - 35	
White beans, pre-softened (250 g + 1 l of water / 9 oz + 2 pint of water)	unperforated	212 (100)	100	55 - 65	





## Desserts

Food	Cooking container	Temperature in °F (°C)	Humidity in %	Cooking time in min.	Observations
Crème brûlée (130 g / 4½ oz)	unperforated	195 (90)	100	40 - 45	In soufflé pan, cover with heat-resistant plastic wrap.
Steamed dumplings / yeast dumplings (100 g / 3½ oz apiece)	unperforated	212 (100)	100	20 - 30	Let the steamed dumplings rise 30 min. before steaming (see "Cooking" chapter).
Flan / Crème caramel (130 g / 4½ oz)	perforated	195 - 205 (90 - 95)	100	30 - 35	In soufflé pan, cover with heat-resistant plastic wrap.
Compote	unperforated	212 (100)	100	15 - 25	e.g. apples, pears, rhubarb  Recipe tip: add sugar, vanilla sugar, cinnamon or lemon juice.
Rice pudding (250 g / 9 oz of rice + 625 ml / 1.3 pint of milk)	unperforated	212 (100)	100	35 - 45	Recipe tip: add fruits, sugar or cinnamon.
Sweet bake	unperforated	355 - 390 (180 - 200)	0 / 60	20 - 40	e.g. semolina, quark or pre-cooked rice pudding

## Other

Food	Cooking container	Temperature in °F (°C)	Humidity in %	Cooking time in min.	Observations
Disinfect (e.g. baby bottles, canning jars)	Wire rack	212 (100)	100	20 - 25	
Drying fruit or vegetables	perforated	175 - 210 (80 - 100)	0	180 - 300	e.g. tomatoes, mushrooms, zucchini, apples, pears, etc. in thin slices
Eggs, size M (5)	perforated	212 (100)	100	8 - 15	
Egg custard (500 g / 1 lb 2 oz)	Glass pan, wire rack	195 (90)	80 - 100	25 - 30	Cover with heat-resistant plastic wrap.
Semolina dumplings	unperforated	195 - 205 (90 - 95)	100	8 - 10	
Lasagne	unperforated	340 - 375 (170 - 190)	0 / 60	35 - 60	
Soufflé	Soufflé pan, wire rack	355 - 390 (180 - 200)	60	12 - 20	
Melting chocolate	Heat-resistant bowl, wire rack	212 (100)	100	5 - 8	Cover with heat-resistant plastic wrap.

## Baked goods

- Using the steam oven, you can always prepare your baked items with the optimum humidity:
  -  | Hot air + 0% humidity: surplus liquid can escape in the case of fruit cakes and quiche. This mode corresponds to hot air in the conventional oven.
  -  | Hot air + 30% humidity: Mixed cake does not dry out. The intrinsic humidity in a foodstuff cannot escape from the oven interior.
-  -  | Hot air + 60 - 100% humidity: Puff pastry and yeast-risen pastries become looser on the inside and crispy on the outside with a gloss.
- You can only bake on one level in the steam oven. Insert the unperforated cooking insert into the second level from below. When using a high baking form, place it on the rack, which you then insert in the first level from below.
- Also when baking, leave the grease filter in the appliance.

Foodstuff	Cooking receptacle	Temperature in °F (°C)	Humidity in %	Cooking time in min.	Remarks
Apple pie	20 cm spring-form tin, rack	320 - 340 (160 - 170)	0	70 - 80	
Bagels (100 g/3.5 oz. each)	Unperforated	375 - 410 (190 - 210)	80/100	20 - 25	
Baguette, prebaked	Rack	375 - 390 (190 - 200)	60/100	10 - 15	
Sponge cake base, high (6 eggs)	Springform	320 - 340 (160 - 170)	0	30 - 35	
Jelly roll (2 eggs)	Unperforated	410 - 430 (210 - 220)	0/30	6 - 8	
Small flaky pastry cakes and cookies	Unperforated	355 - 390 (180 - 200)	80/100	15 - 25	
Bread rolls (50 - 100 g /1.8 - 3.5 oz. each)	Unperforated	355 - 390 (180 - 200)	80/100	15 - 25	
Bread rolls, prebaked	Rack	340 - 355 (170 - 180)	60	8 - 15	
Bread (1 - 1.5 kg)	Unperforated	1) 390 (200)	100	15	
		2) 320 - 330 (160 - 165)	0	25 - 35	
Flat cake made out of cake mixture	Unperforated	300 - 320 (150 - 160)	0	25 - 30	
Bundt cake (yeast dough from 1 kg/2 lb of flour)	Bundt pan	320 - 345 (160 - 175)	30/60	35 - 45	
Yeast tray bake	Unperforated	320 - 340 (160 - 170)	30/60	30 - 45	Use 30 % humidity for yeast tray bakes with a moist topping (e.g. plum cake or onion tart) and 60 % humidity for a dry topping (e.g. crumble).
'Hefezopf' (500 g/1 lb of flour)	Unperforated	300 - 320 (150 - 160)	60/80	20 - 30	
Muffins	Muffin tray, rack	340 - 355 (170 - 180)	0/30	20 - 30	
Macaroons	Unperforated	285 - 300 (140 - 150)	0	25 - 35	
Cookies	Unperforated	300 - 340 (150 - 170)	0	15 - 25	
Quiche, tart	Quiche form, rack	355 - 375 (180 - 190)	0	35 - 60	

Foodstuff	Cooking receptacle	Temperature in °F (°C)	Humidity in %	Cooking time in min.	Remarks
Mixed cake	Cake tin/ springform, rack	320 - 345 (160 - 175)	30	50 - 60	
Small cakes	Unperforated	300 - 320 (150 - 160)	0	35 - 45	
Cookies	Unperforated	300 - 320 (150 - 160)	0	25 - 30	
Tart	Tart form, rack	375 - 410 (190 - 210)	0/30	30 - 45	
Cream puffs, eclairs	Unperforated	340 - 355 (170 - 180)	0/30	40 - 45	

## Refreshing (warming up)

- In the steam oven, you can generate the optimum climate for warming ready-cooked meals without them drying out. Thus, taste and quality are preserved, and meals taste like freshly prepared.
- Use the "Refreshing" mode  to do this.
- The data refers to portions for one person. You can also warm up large quantities in the unperforated cooking insert. The specified times are lengthened.

Food	Cooking container	Temperature in °F (°C)	Cooking time in min.	Observations
Baguettes, rolls (frozen)	Wire rack	285 (140)	10 - 15	
Baguettes, rolls (day-old)	Wire rack	355 (180)	5 - 8	
Roast, in slices (150 g / 5 oz)	unperforated	250 (120)	12 - 15	Finger-thick slices, do not place on top of each other, to keep juicy, add sauce to the cooking container.
Vegetables	Plate, wire rack	195 - 212 (90 - 100)	8 - 10	
Pizza, thin	Wire rack	355 (180)	10 - 12	
Pizza, thick	Wire rack	355 (180)	12 - 14	
Starchy side dishes	Plate, wire rack	250 (120)	7 - 8	e.g. noodles, potatoes, rice, not suitable are baked or fried foods such as french fries or croquettes
Plated meals	Plate, wire rack	250 (120)	8 - 15	

## Dough proving (leaving to rise)

- The steam oven offers the ideal climate for raising dough and dough mixtures or dough pieces without drying them out.
- Use the "Dough proofing" mode  to do this.
- The bowl need not be covered with a moist cloth. Raising only takes half as much as it used to.
- The specified dough proofing time is for your orientation only. Raise dough until its volume has doubled.

Foodstuff	Cooking receptacle	Temperature in °F (°C)	Cooking time in min.	Remarks
Dough mixture	Bowl/rack	100 (38)	25 - 45	e.g. yeast dough, self-raising flour and sour dough

## Defrosting

- In the steam oven you can gently and evenly thaw deep frozen foods faster than at room temperature.
- Use the "Defrosting" mode \* $\delta$  to do this.
- The specified thawing times are for your orientation only. The time it takes to thaw depends on the size and weight of the frozen food: freeze your foods flatly or individually. This shortens the thawing time.
- Take foods out of the packaging before thawing them.
- Thaw only the amount you immediately need.
- Remember: in certain circumstances, thawed food does not keep so well and goes bad faster than fresh food. Immediately process thawed food and cook it thoroughly.
- After half of the thawing time, turn meat or fish over fish or separate fragmentary frozen food such as

berries or bits of meat. Fish need not thaw fully. It suffices if the surface is soft enough to absorb the spices.

---

### WARNING

#### Health risk

When thawing animal foodstuffs, it is imperative to remove the liquid that arises during thawing. It must never come into contact with other foodstuffs. Germs could be transmitted. Slide the unperforated cooking insert underneath the food. Pour away the collected thawing liquid from meat and poultry. Then clean the sink and rinse with plenty of water. Clean the cooking insert in hot soapy solution or in a dishwasher. After defrosting, operate the steam oven for 15 minutes with Convection at 350 °F (approx. 180 °C).

---

Foodstuff	Cooking receptacle	Temperature in °F (°C)	Heating function	Cooking time in min.	Remarks
Berries (300 g/10.5 oz.)	Perforated	105 - 115 (40 - 45)	* $\delta$	3 - 4	
Roast (1,000 g/2 lb)	Perforated	105 - 115 (40 - 45)	* $\delta$	45 - 60*	
Fish fillet (150 g/ 5 oz. each)	Perforated	105 - 115 (40 - 45)	* $\delta$	5 - 10*	
Vegetables (400 g / 14 oz.)	Perforated	105 - 115 (40 - 45)	* $\delta$	5 - 7	
Goulash (600 g/ 21 oz.)	Perforated	115 - 120 (45 - 50)	* $\delta$	30 - 45*	
Chicken (1,000 g/2 lb)	Perforated	115 - 120 (45 - 50)	* $\delta$	45 - 60*	
Chicken leg (400 g/14 oz. each)	Perforated	115 - 120 (45 - 50)	* $\delta$	20 - 30*	

\* You should add some extra time for this dish: switch off the appliance after the thawing time has elapsed and leave dishes in the closed appliance for another 10 - 15 minutes so that they can thaw completely to their interior.

## Preserving

- In combination steam ovens, you can can fruit and vegetables with little effort.
- If possible, cook food immediately after purchase or harvesting. Longer storage decreases the vitamin content and can cause spoilage.
- Only use fruit and vegetables in good condition.
- The combination steam oven is not suited for preserving meat.
- Check and clean the canning jars, rubber rings, clamps, and springs carefully.
- You can disinfect the clean jars in your combination steam oven at 212°F (100 °C) and 100% humidity for 20 - 25 min before you preserve the fruit in them.
- Place the jars in the perforated cooking container. They must not be in contact with each other.
- Open the cooking compartment door after the cooking time has elapsed. Do not remove the canning jars from the appliance until they have completely cooled down.

Food	Cooking container	Temperature in °F (°C)	Humidity in %	Cooking time in min.	Observations
Fruit, vegetables (in closed 0.75 l / ½ pint canning jars)	perforated	212 (100)	100	35 - 40	
Beans, peas (in closed 0.75 l / ½ pint canning jars)	perforated	212 (100)	100	120	

## Extracting juice (soft fruits)

- You can effortlessly and cleanly extract berry juice in the steam oven.
- Place the berries in the perforated cooking insert and slide it into the third level from below. Slide in the unperforated cooking insert one level below it to collect the liquid.
- Leave the berries in the appliance until no more juice appears.
- You can then squeeze the berries dry in a dishtowel to preserve the last remainders of juice.

Food	Cooking container	Temperature in °F (°C)	Humidity in %	Cooking time in min.	Observations
Berries	perforated + unperforated	212 (100)	100	60 - 120	

## Preparing yoghurt

- You can even prepare your own yogurt in the combination steam oven.
- Heat pasteurized milk to 195°F (90°C) on the burner in order to prevent a disturbance of the yogurt cultures. Ultra-high-heated milk (H-milk) does not have to be heated. (Note: if you want to make yogurt with cold milk, the resting period is longer).
- NB! Leave milk cool to 105°F (40°C) in the water bath so as not to destroy the yogurt cultures.
- Stir natural yogurt into the milk with active yogurt cultures (1 - 2 teaspoons of yoghurt for every 100 ml).
- For yogurt enzymes, heed the package instructions.
- Fill the yogurt into clean jars.
- You can disinfect the clean jars in your combination steam oven at 212°F (100°C) and 100% humidity for 20 - 25 min before you pour the yogurt in. Make sure to let the jars and the cooking compartment cool off before you pour the yogurt into them and place the jars in the appliance.
- After preparation, put the yogurt in the refrigerator.
- To make thicker yogurt, add skin milk powder to the milk before heating (1-2 tablespoons per liter).

Food	Cooking container	Temperature in °F (°C)	Humidity in %	Cooking time in min.	Observations
Yogurt approach (in sealed jars)	unperforated	115 (45)	100	300 - 360	Recipe tip: if you use the yogurt approach with fruit puree, jam, honey, vanilla or chocolate flavoring, then you may need to extend the preparation time.

## Preparing bulky food

- For the preparation of bulky foods, you can also remove the side slide-in tray.
- To do this, loosen the knurled screws at the front of the slide-in tray and pull the tray out toward the front.
- Place the wire rack directly on the bottom of the cooking compartment and place the food or the roasting dishes on the wire rack. Do not place the food or the roasting dishes directly on the enameled bottom.

## Acrylamide in foodstuffs

Which foods are affected?

Acrylamide is mainly produced in grain and potato products that are heated to high temperatures, such as chips, fries, toast, rolls, bread, fine baked goods (cookies, gingerbread, Christmas spice cookies).

### Tips for keeping acrylamide to a minimum when preparing food

General	Keep cooking times as short as possible. Cook food until it is golden brown, but not too dark. Large, thick pieces of food contain less acrylamide.
Baking	With hot air at max. 355° F (180 °C).
Cookies	Egg or egg yolk reduces the production of acrylamide. Spread out a single layer evenly on the baking tray.
Oven French fries	Cook at least 400 g at once on a baking tray so that the fries do not dry out.









**Gaggenau**

BSH Home Appliance Corporation

1901 Main Street, Suite 600

Irvine, CA 92614

+1.877.442.4436

USA

[www.gaggenau-usa.com](http://www.gaggenau-usa.com)

© 2017 BSH Home Appliances

**Gaggenau Hausgeräte GmbH**

Carl-Wery-Straße 34

81739 München

GERMANY

**GAGGENAU**

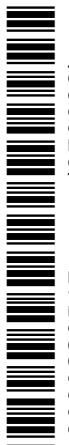

9000880517 en-us (970622)