

**RF 411**

**RF 413**

**RF 461**

**RF 463**

**RF 471**

Freezer

---

## en Table of Contents

---

Safety and warning information	3	Max. freezing capacity	13
Information concerning disposal	5	Freezing fresh food	14
Scope of delivery	5	Fast freezing	14
Installing the appliance	5	Thawing frozen food	15
Ambient temperature and ventilation	6	Ice maker	15
Connecting the appliance	6	Ice and water dispenser	16
Getting to know your appliance	8	Interior fittings	18
Switching the appliance on	10	Switching off and disconnecting the appliance	18
Set the language	10	Defrosting	18
Setting the temperature unit	10	Cleaning the appliance	19
Setting the temperature	10	Light (LED)	20
Special functions	11	Tips for saving energy	20
Alarm function	13	Operating noises	20
Usable capacity	13	Eliminating minor faults yourself	21
Freezer compartment	13	Customer service	24

## **Safety and warning information**

### **Before you switch ON the appliance**

Please read the operating and installation instructions carefully! They contain important information on how to install, use and maintain the appliance.

The manufacturer is not liable if you fail to comply with the instructions and warnings. Retain all documents for subsequent use or for the next owner.

### **Technical safety**

The tubes of the refrigeration circuit convey a small quantity of an environmentally friendly but flammable refrigerant (R600a). It does not damage the ozone layer and does not increase the greenhouse effect. If refrigerant escapes, it may injure your eyes or ignite.

#### **If damage has occurred**

- Keep naked flames and/or ignition sources away from the appliance,
- thoroughly ventilate the room for several minutes,
- switch off the appliance and pull out the mains plug,
- inform customer service.

The more refrigerant an appliance contains, the larger the room must be in which the appliance is situated. Leaking refrigerant can form a flammable gas-air mixture in rooms which are too small.

The room must be at least 1 m<sup>3</sup> per 8 g of refrigerant. The amount of refrigerant in your appliance is indicated on the rating plate inside the appliance.

If the power cord of this appliance is damaged, it must be replaced by the manufacturer, customer service or a similarly qualified person. Improper installations and repairs may put the user at considerable risk.

Repairs may be performed by the manufacturer, customer service or a similarly qualified person only.

Only original parts supplied by the manufacturer may be used. The manufacturer guarantees that only these parts satisfy the safety requirements.

Do not use multiple sockets, extension leads or adapters.

The hose set must only be purchased from and installed by customer service.

### **Important information when using the appliance**

- Never use electrical appliances inside the appliance (e.g. heater, electric ice maker, etc.). Explosion hazard!
- Never defrost or clean the appliance with a steam cleaner! The steam may penetrate electrical parts and cause a short-circuit. Risk of electric shock!
- Do not use pointed and sharp-edged implements to remove frost or layers of ice. You could damage the refrigerant tubes. Leaking refrigerant may cause eye injuries or ignite.
- Do not store products which contain flammable propellants (e.g. spray cans) or explosive substances in the appliance. Explosion hazard!
- Do not stand on or lean heavily against base of appliance, drawers or doors, etc
- For cleaning pull out mains plug or switch off fuse. Do not pull out the mains plug by tugging on the power cord.
- Store high-percentage alcohol tightly closed and standing up.
- Keep plastic parts and the door seal free of oil and grease. Otherwise, parts and door seal will become porous.
- Never cover or block the ventilation openings of the appliance!

- **Avoiding placing children and vulnerable people at risk:**

At risk are children, people who have limited physical, mental or sensory abilities, as well as people who have inadequate knowledge concerning safe operation of the appliance.

Ensure that children and vulnerable people have understood the hazards. A person responsible for safety must supervise or instruct children and vulnerable people who are using the appliance.

Only children from 8 years and above may use the appliance.

Supervise children who are cleaning and maintaining the appliance.

Never allow children to play with the appliance.

- Do not store bottled or canned drinks (especially carbonated drinks) in the freezer compartment. Bottles and cans may burst!
- Never put frozen food straight from the freezer compartment into your mouth. Risk of low-temperature burns!
- Avoid prolonged touching of frozen food, ice or the evaporator pipes, etc. Risk of low-temperature burns!

## **Children in the household**

- Keep children away from packaging and its parts.  
Danger of suffocation from folding cartons and plastic film!
- Do not allow children to play with the appliance!
- If the appliance features a lock: keep the key out of the reach of children!

## **General regulations**

The appliance is suitable

- for freezing food,
- for making ice,
- for dispensing drinking water.

This appliance is intended for use in the home and the home environment.

The appliance is suppressed according to EU Directive 2004/108/EC.

The refrigeration circuit has been checked for leaks.

This product complies with the relevant safety regulations for electrical appliances (EN 60335-2-24).

This appliance is intended for use up to a maximum height of 2000 metres above sea level.

---

## Information concerning disposal

---

### Disposal of packaging

The packaging protects your appliance from damage during transit. All utilised materials are environmentally safe and recyclable. Please help us by disposing of the packaging in an environmentally friendly manner.

Please ask your dealer or inquire at your local authority about current means of disposal.

### Disposal of your old appliance

Old appliances are not worthless rubbish! Valuable raw materials can be reclaimed by recycling old appliances.



This appliance is labelled in accordance with European Directive 2012/19/EU concerning used electrical and electronic appliances (waste electrical and electronic equipment - WEEE). The guideline determines the framework for the return and recycling of used appliances as applicable throughout the EU.

### Warning

Redundant appliances

1. Pull out the mains plug.
2. Cut off the power cord and discard with the mains plug.
3. Do not take out the trays and receptacles: children are therefore prevented from climbing in!
4. Do not allow children to play with the appliance once it has spent its useful life. Danger of suffocation!

Refrigerators contain refrigerant and gases in the insulation. Refrigerant and gases must be disposed of professionally. Ensure that tubing of the refrigerant circuit is not damaged prior to proper disposal.

---

## Scope of delivery

---

After unpacking all parts, check for any damage in transit.

If you have any complaints, please contact the dealer from whom you purchased the appliance or our customer service.

**The delivery consists of the following parts:**

- Built-in appliance
- Interior fittings (depending on model)
- Bag containing installation materials
- Operating instructions
- Installation manual
- Customer service booklet
- Warranty enclosure
- Information on the energy consumption and noises

---

## Installing the appliance

---

Have a technician install and connect the appliance according to the enclosed installation instructions.

### Transporting

The appliance is heavy. Secure in position during transportation and installation.

Due to the weight/dimensions of the appliance and to minimise the risk of injury and damage to the appliance at least two persons are necessary to set-up the appliance safely.

### Installation location

A dry, well ventilated room is suitable as an installation location. The installation location should not be exposed to direct sunlight and not placed near a heat source, e.g. a cooker, radiator, etc. If installation next to a heat source is unavoidable, use a suitable insulating plate or observe the following minimum distances from the heat source:

- 3 cm to electric or gas cookers.
- 30 cm to an oil or coal-fired cooker.

The floor of the installation location must not give way; if required, reinforce floor. To ensure that the ice maker functions correctly, the appliance must be upright.

---

## Ambient temperature and ventilation

---

### Ambient temperature

The climate class can be found on the rating plate. The climate class indicates within which ambient temperatures the appliance can be operated.

Climate class	Permitted ambient temperature
SN	+10 °C to 32 °C
N	+16 °C to 32 °C
ST	+16 °C to 38 °C
T	+16 °C to 43 °C

#### Note

The appliance is fully functional within the room temperature limits of the indicated climatic class. If an appliance of climatic class SN is operated at colder room temperatures, the appliance will not be damaged up to a temperature of +5 °C.

### Ventilation

Conduction of the heated air must not be obstructed. Otherwise, the refrigeration unit must work harder. This increases power consumption. Therefore: Never cover or block the ventilation opening!

---

## Connecting the appliance

---

Have a technician install and connect the appliance according to the enclosed installation instructions.

Do not remove the transportation protection devices from the shelves and storage compartments until the appliance has been installed.

Always connect the water before the power.

Apart from statutory national regulations, you should stick to the connection terms relating to the local electricity and water companies.

After installing the appliance, wait at least 1 hour until the appliance starts up. During transportation the oil in the compressor may have flowed into the refrigeration system.

Before switching on the appliance for the first time, clean the interior of the appliance (see chapter "Cleaning the appliance").

## Water connection

The water may be connected only by a competent fitter according to the local regulations of the appropriate water supply company.

#### Caution

Risk of appliance being damaged by particles! The water filter must always be connected to the tap – even if an additional filter system is used.

#### Caution

Use only the enclosed hose set or a hose set purchased from customer service for connection to the drinking water mains.

The hose set must only be installed by customer service.

Do not use existing or already used hose sets.

Connect the appliance to a drinking water line only:

- Minimum pressure: 0.2 Mpa (2 bar)
- Maximum pressure: 0.8 Mpa (8 bar)
- Pressure over 0.8 MPa (8 bar): install a pressure limiter between drinking water connection and hose set

A separate shut-off valve should be installed in the cold-water inflow.

The shut-off valve should not be located behind the appliance. It is recommended that you mount the shut-off valve directly next to the appliance or at another place which is easily accessible.

When installing the water connection, pay attention to the permissible installation area for the water mains.

For connection to the drinking water mains use only water pipes which are suitable for drinking water. Observe national regulations and the connection conditions of the local water supply companies.

#### Note

The maximum outside diameter of the water mains (without connecting pieces) is 10 mm.

## Water filter

### Warning

Health risks due to contaminated water!  
The filter is NOT used to disinfect the water. If the on-site water quality is questionable or not enough is known about it, disinfect water before use.

A replacement filter screen can be purchased from customer service or a specialist dealer.

### Caution

- Risk of appliance being damaged by particles!  
The water filter must always be connected to the tap – even if an additional filter system is used.
- After installing a new filter, always discard the ice produced within the first 24 hours after switching on the ice maker.
- If the ice has not been used for a prolonged period, pour all ice cubes out of the container and also discard the ice produced within the next 24 hours.

## Installing water filter

1. Insert filter screen into the filter housing (if not already fitted ex works).

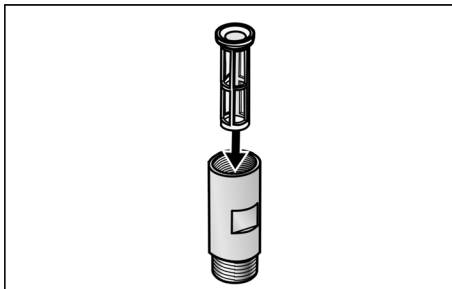

2. Place seal in the filter housing and connect to the tap ( $\frac{3}{4}$ " threaded connection).

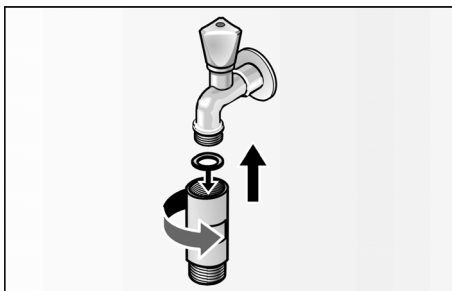

3. Using an open-end wrench, connect water supply hose with seal to the filter housing (if not already fitted ex works).

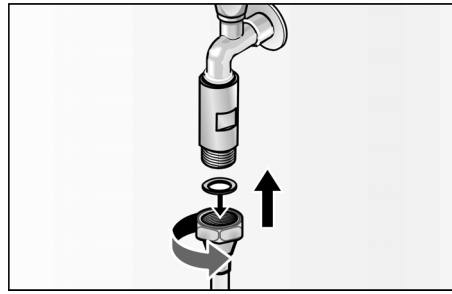

4. Carefully turn on the tap and check that the connection points are not leaking.

### Caution

**There must be no leaking water!**

If required, tighten the threaded connections to a higher torque.

## Electrical connection

The socket must be near the appliance and also freely accessible following installation of the appliance.

### Warning

Risk of electric shock!

If the length of the mains cable is inadequate, never use multiple sockets or extension leads. Instead, please contact Customer Service for alternatives.

The appliance complies with protection class I. Connect the appliance to 220–240 V/50 Hz alternating current via a correctly installed socket with protective conductor. The socket must be protected by a (10–16 A) fuse.

For appliances operated in non-European countries, check whether the indicated voltage and current type match the values of your electricity supply. This information can be found on the rating plate (see chapter entitled Customer Service).

### Warning

Never connect the appliance to electronic energy saver plugs.

Our appliances can be used with mains and sine-controlled inverters. Mains-controlled inverters are used for photovoltaic systems which are connected directly to the national grid. Sine-controlled inverters must be used for isolated applications (e.g. on ships or in mountain lodges) which are not connected directly to the national grid.

## Getting to know your appliance

These operating instructions refer to several models. The diagrams may differ.

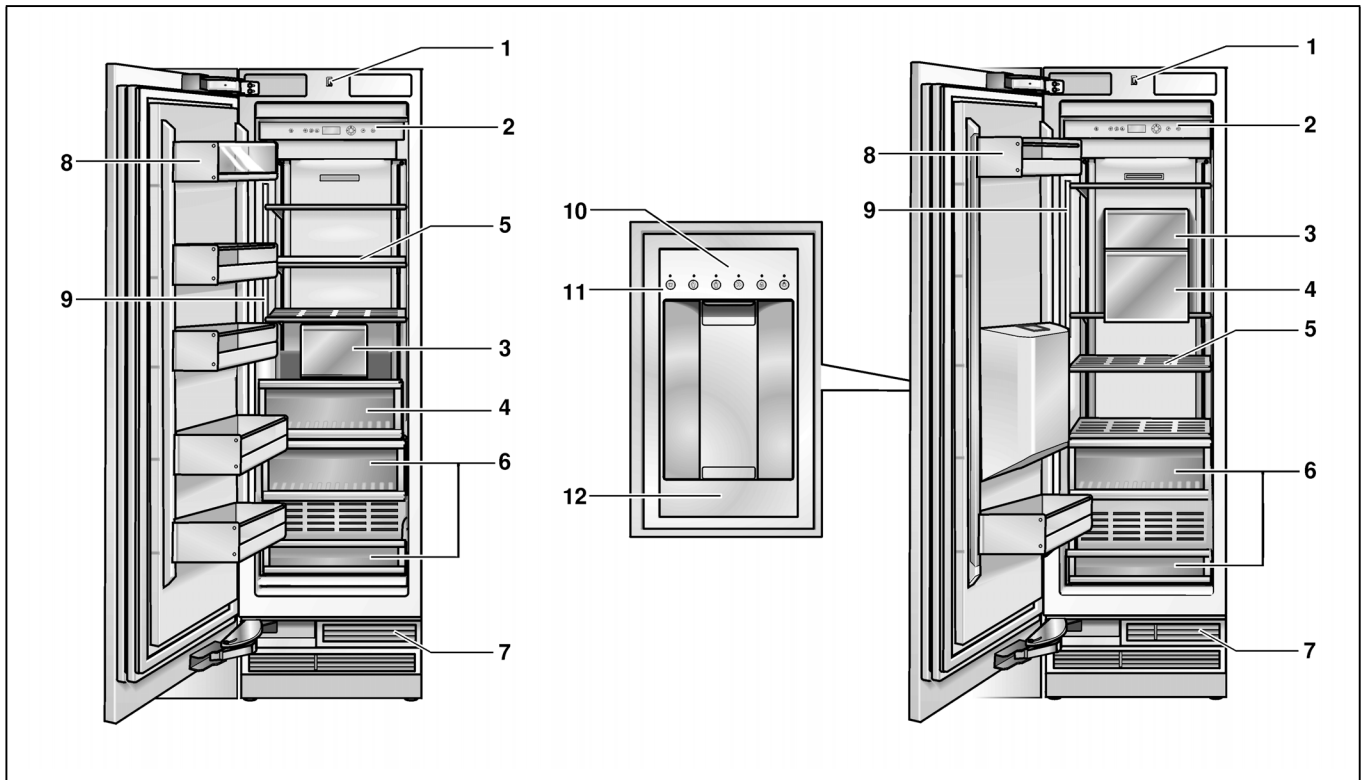

- 1 Light switch
- 2 Controls
- 3 Ice maker
- 4 Ice cube container
- 5 Shelf in the freezer compartment
- 6 Container
- 7 Ventilation
- 8 Door shelf
- 9 Light (LED)
- 10 Ice and water dispenser
- 11 Controls for the ice and water dispenser
- 12 Water collecting tray



# Controls

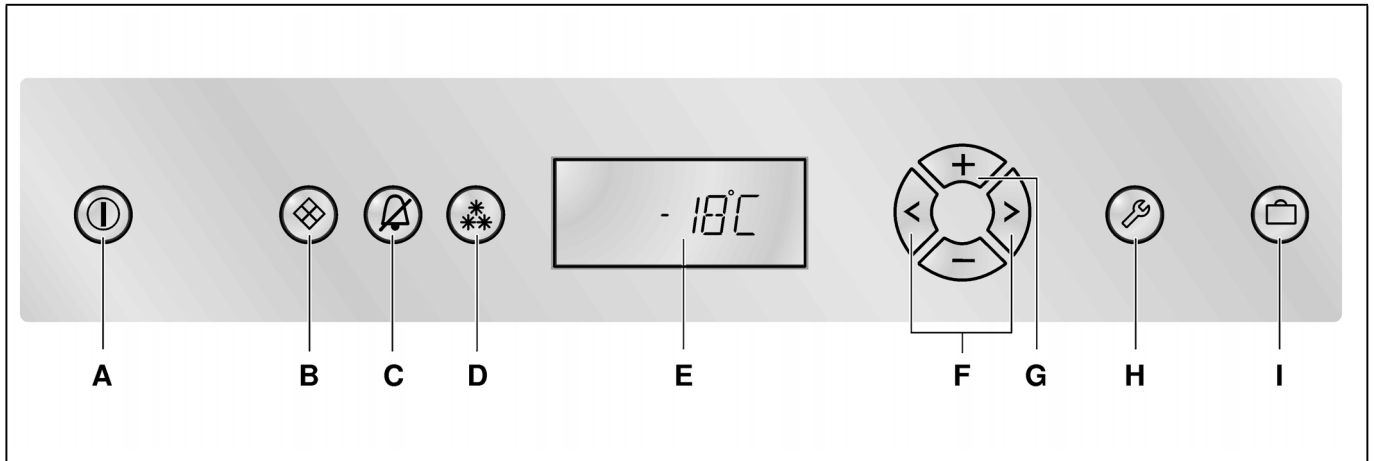

**A On/Off button** ①  
Serves to switch the whole appliance on and off.

**B Ice maker button** ②  
Serves to switch the ice maker on and off, see chapter Ice maker.

**C Alarm button** ③  
Used to switch off the warning signal, (see chapter Alarm function).

**D Fast freezing button** ④  
Switches fast freezing on and off, see chapter Fast freezing.

**E Display panel**  
The temperatures in the freezer compartment are shown in the display panel. Activated special functions are shown via “symbol”.  
The menus and setting options which are available are represented on the display panel in the setup mode, see chapter “Special functions”.

**F Selection buttons** < >  
The temperature setting is activated using the selection buttons (see chapter Setting the temperature).  
For selecting a menu in the setup mode (see chapter Special functions).

**G Setting buttons** +/-  
The temperature can be changed using the setting buttons (see chapter “Setting the temperature”).  
More settings can be selected in the setup mode, (see chapter “Special functions”).





**H “setup” button** ⑤  
This button starts and ends the setup mode. If the setup mode is ended using the setup button, the changes which have been made are stored.

**I Holiday button** ⑥  
Is used to switch holiday mode on and off, (see chapter Special functions, section Holiday mode).

### Note

A sound can be heard every time a button is actuated if this function is activated in the sound menu during the setup mode.

### Symbols in the display field

-  Fast freezing is activated (see chapter “Fast freezing”).
-  Holiday mode is activated, see chapter Special functions.
-  For the setting options in the set up mode, see chapter Special functions.
-  A warning message is displayed, see chapter Alarm function.
-  Ice maker is switched on, see chapter Ice maker.

## Controls for the ice and water dispenser



Water request button.



Ice cube request button.



Crushed ice request button.



Switch the quick ice function on and off.



Lock button for the ice and water maker control panel (childproof lock).  
To lock and unlock, hold down the button for 3 seconds.



Switch permanent light function on and off.

---

## Switching the appliance on

---

Switch on the appliance with the On/Off button ①.

The appliance begins to cool. Light is switched on when the door is open.

## Operating tips

- When the appliance has been switched on, it may take several hours until the set temperature has been reached.
- The fully automatic NoFrost system ensures that the freezer compartment remains free of ice. Defrosting is not required.

---

## Set the language

---

The display languages can be changed according to the table in the chapter "Special functions", "Setup mode".

In order to change the display language:

1. Press setup button ②.
2. Press the < or > setting button, until the set language is displayed.
3. Press the + or - setting button, until the desired language is displayed.
4. Press the setup button ②, in order to store the settings. The set temperature is displayed again in the fascia.

---

## Setting the temperature unit

---

The temperature can be displayed in degrees Celsius (°C) or degrees Fahrenheit (°F).

1. Press setup button ②.  
The first menu (temperature unit) is displayed.
2. Press the + or - setting button in order to switch between degrees Fahrenheit (°F) and degrees Celsius (°C).
3. Press the setup button ②, in order to store the settings.  
The set temperature is displayed again in the fascia.

---

## Setting the temperature

---

### Freezer compartment

(can be selected from -16 °C to -24 °C)

We recommend a setting of -18 °C.

1. Activate the setup mode with the selection button <.
2. Set the desired temperature with the + (warmer) or - (cooler) setting buttons.

## Special functions

The following special functions can be selected or displayed:

### Setup mode

In Setup mode you can make your personal settings.

#### Switching on

Press setup button .

The first menu (temperature unit) is displayed in the fascia.

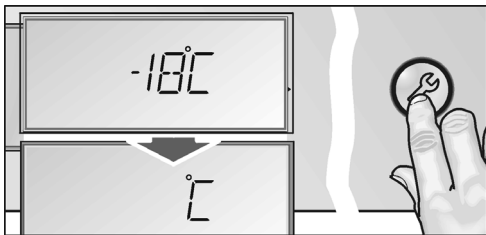

#### Making settings

1. Switch on setup mode.
2. Press the selection button < or >.  
The next menu is displayed and its current setting (mostly **ON** or **OFF**).

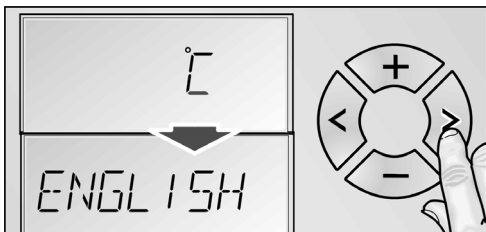

3. Press the setting button + or -.  
The setting is saved, if the next menu is selected using < or >.

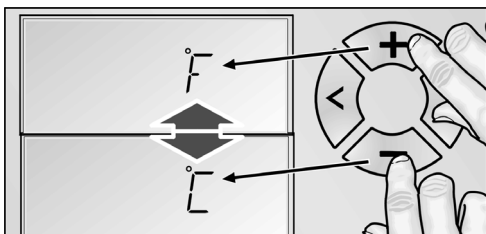

#### Switching off

Press setup button .

All of the changed settings are stored.

### Note

If no button is selected within 20 seconds, the setup mode ends automatically. All of the changed settings are stored. The set temperature is displayed again in the fascia.

### Menus in the setup mode

The following settings can be made.

Menu	Possible setting
Temperature unit	°C (degrees Celsius)
	°F (degrees Fahrenheit)
Language	Deutsch
	English
	French
	Danish
	Finnish
	Greek
	Dutch
	Italian
	Polish
	Portuguese
	Norwegian
Russian	
Swedish	
Spanish	
Turkish	
Czech	
Sound	On
	Off
Energy saving mode (eco function)	On
	Off

## Holiday mode

If leaving the appliance for a long period of time, you can switch the appliance over to the energy-saving holiday mode.

When holiday mode is switched on, the following settings are made:

- The appliance works in energy saving mode.
- The illumination is switched off.
- The fast freezing function is ended (if activated).

### Switching on

Press Holiday button .

**VACATION** is displayed in the display panel.

### Switching off

Press Holiday button .



The previous settings and temperature values are once again activated.

## Rest mode

When Rest mode is switched on, the following settings are switched off:

- Ice maker
- Acoustic signal
- Interior light
- Messages on the display panel
- The background illumination of the display panel is reduced
- Buttons are locked

### Switching on

1. Press the fast freezing button  and keep it held down.
2. Press Holiday button .
3. Hold the fast freezing button  down for 3 seconds longer.  
The symbol **VACATION** flashes on the display panel and **RESTMODE** is displayed.

### Switching off





Press Holiday button .

The previous settings and temperature values are once again activated.





## Energy saving mode

If the energy saving function (eco function) is activated, the appliance switches to energy saving operation. This energy saving function is preset at the factory in order to reduce energy consumption. The background illumination of the fascia is likewise reduced.

### Switching on

1. Press setup button .
2. Press the selection button , until **ECO MODE** and the current setting (**OFF**) is displayed.
3. Press the setting button , in order to reset the setting.
4. Press the setup button , in order to store the setting.  
**ECO** is displayed in the fascia.

### Switching off

1. Press setup button .
2. Press the selection button , until **ECO MODE** and the current setting (**ON**) is displayed.
3. Press the setting button , in order to reset the setting.
4. Press the setup button , in order to store the setting.

---

## Alarm function

---

### Door alarm

The door alarm switches on if an appliance door is left open for longer than three minutes. Close the door to switch off the warning signal.

### Temperature alarm

The temperature alarm switches on if the freezer compartment is too warm and the frozen food is at risk of thawing.

The set temperature of the freezer compartment flashes and "Alarm" is displayed on the display panel.

When the alarm button  is pressed, the temperature display for the freezer compartment indicates for five seconds the warmest temperature reached in the freezer compartment.

Then this value is deleted. The temperature display for the freezer compartment indicates the set freezer compartment temperature without flashing.

Henceforth the "warmest temperature" will be redefined and saved.

The alarm display goes out as soon as the set temperature has been reached again.

#### **The alarm may switch on without any risk to the frozen food:**

- when the appliance is switched on,
- when large quantities of fresh food are placed in the appliance,
- if the freezer compartment door is open too long.

### Switching off the alarm

Press the alarm button  to switch off the warning signal.

---

## Usable capacity

---

Information on the usable capacity can be found inside your appliance on the rating plate (see diagram at chapter "Customer service").

---

## Freezer compartment

---

Use the freezer compartment:

- To store deep-frozen food.
- To freeze food.
- To make ice cubes.

#### **Note**

Ensure that the freezer compartment door is always closed properly. If the door is open, the frozen food will thaw. The freezer compartment will become covered in thick ice.

Also: Energy will be lost due to high power consumption.

### Purchasing frozen food

- Packaging must not be damaged.
- Use by the "use by" date.
- Temperature in the supermarket freezer must be  $-18\text{ }^{\circ}\text{C}$  or lower.
- If possible, transport deep-frozen food in an insulated bag and place quickly in the freezer compartment.

---

## Max. freezing capacity

---

Information about the max. freezing capacity within 24 hours can be found on the rating plate (see diagram at chapter "Customer service").

---

## Freezing fresh food

---

Freeze fresh and undamaged food only.

To retain the best possible nutritional value, flavour and colour, vegetables should be blanched before freezing. Aubergines, peppers, zucchini and asparagus do not require blanching.

Literature on freezing and blanching can be found in bookshops.

### Note

Keep food which is to be frozen away from food which is already frozen.

- The following foods are suitable for freezing: Cakes and pastries, fish and seafood, meat, game, poultry, vegetables, fruit, herbs, eggs without shells, dairy products such as cheese, butter and quark, ready meals and leftovers such as soups, stews, cooked meat and fish, potato dishes, soufflés and desserts.
- The following foods are not suitable for freezing: Types of vegetables, which are usually consumed raw, such as lettuce or radishes, eggs in shells, grapes, whole apples, pears and peaches, hard-boiled eggs, yoghurt, soured milk, sour cream, crème fraîche and mayonnaise.

## Packing frozen food

To prevent food from losing its flavour or drying out, place in airtight containers.

1. Place food in packaging.
2. Remove air.
3. Seal the wrapping.
4. Label packaging with contents and date of freezing.

### Suitable packaging:

Cling wrap, tubular film made of polyethylene, aluminium foil, freezer containers.

These products are available from specialist outlets.

### Unsuitable packaging:

Wrapping paper, greaseproof paper, cellophane, bin liners and used shopping bags.

### Items suitable for sealing packaged food:

Rubber bands, plastic clips, string, cold-resistant adhesive tape, etc.

Bags and tubular film made of polyethylene (PE) can be sealed with a film heat sealer.

## Shelf life of frozen food

Storage duration depends on the type of food.

At a temperature of  $-18\text{ }^{\circ}\text{C}$ :

- Fish, sausage, ready meals and cakes and pastries:  
up to 6 months
- Cheese, poultry and meat:  
up to 8 months
- Vegetables and fruit:  
up to 12 months

---

## Fast freezing

---

Food should be frozen solid as quickly as possible in order to retain vitamins, nutritional value, appearance and flavour.

To prevent an undesirable temperature rise when placing fresh food in the freezer compartment, switch on fast freezing several hours beforehand. As a rule, 4–6 hours is adequate. 24 hours are necessary when using the maximum freezer capacity fully.

After 2 days the temperature set before fast freezing is automatically restored.

## Switching on

Press fast freezing button .

The display panel indicates the symbol **SUPER**  and the compartment for which the function was switched on.



## Switching off

Press fast freezing button .

---

## Thawing frozen food

---

Depending on the type and application, select one of the following options:

- at room temperature
- in the refrigerator
- in an electric oven, with/without fan assisted hot-air
- in the microwave

### Caution

Do not refreeze thawing or thawed food. Only ready meals (boiled or fried) may be refrozen.

No longer store the frozen produce for the max. storage period.

---

## Ice maker

---

The ice maker makes ice cubes.

The ice maker starts to make ice cubes as soon as the appliance has reached the set temperature. If the ice cube container is full, the ice maker automatically switches off.

### Caution

Do not place bottles or food in the cube container in order to cool them quickly. The ice maker may block and be damaged.

## Switching on

### Note

If the ice maker is used for the first time and/or a long period of not being used, do not use the ice which is produced in the first day for hygiene reasons. Throw the ice cubes away and clean the container!

1. Make sure that ice maker container is its place and locked into position.
2. Press ice maker button .  
The symbol **ICE** is lit on the display panel.



## Switching off

### Notes

- Switching off for a prolonged period (> 2 days):  
The water supply to the appliance must be interrupted beforehand for 2–3 hours. This prevents stagnant water from collecting in the ice maker.
  - Switching off briefly, e.g. for cleaning: Place a bowl under the dispenser to catch ice cubes or condensation.
1. Press ice maker button .
  2. Empty ice cube container (see chapter Cleaning the ice cube container).

---

## Ice and water dispenser

---

(not all models)

The ice and water dispenser is used to dispense:

- cooled water,
- crushed ice,
- ice cubes.

### **Warning**

Risk of injury!

Never reach into the ice cube dispenser opening of the ice cube container!

### **Caution**

Do not place bottles or food in the cube container in order to cool them quickly. The ice maker may block and be damaged.

## Using the ice and water dispenser

The ice and water dispenser only works when the appliance is connected to the water mains.

When the appliance has been switched on, it takes approx. 24 hours until the first batch of ice cubes are ready.

When the appliance has been connected, there are still air bubbles in the lines.

Run off drinking water and pour away until water can be dispensed without bubbles. Pour away the first 5 glasses.

When using the ice maker for the first time, do not use the first 30-40 ice cubes for reasons of hygiene.

## Observing drinking water quality

All materials used in the drinks dispenser are odourless and tasteless.

If the water has an aftertaste, this may be caused by:

- Mineral and chlorine content of the drinking water.
- Material of the domestic water line and connection line.
- Freshness of the drinking water. If water has not been dispensed for a long time, the water may have a "stale" taste. In this case fill approx. 15 glasses of water and throw away.

We recommend that you regularly dispense a little fresh water from the water maker and that you do not switch off the appliance. This will ensure that the best water quality is retained.

## Operating the ice maker

As soon as the freezer compartment has reached its freezing temperature, ice cube production starts. After 2–3 hours the ready ice cubes are automatically discharged into the ice cube container.

### **Note**

The appliance produces more ice if you lower the freezer compartment temperature. This will slightly increase the energy consumption of your appliance.

Occasionally ice cubes will freeze together and block the dispenser:

1. Open the door and check inside whether ice cubes are sticking to the ice and water dispenser.
2. If the ice and water dispenser is not blocked:

### **Caution**

A full ice cube container is heavy!

Carefully pull out ice cube container and remove ice cubes which are frozen together.

When the ice cube container is full, ice making switches off automatically.



## Dispensing ice/water

- Select the ice and water dispenser button (water, crushed ice or ice cubes).
- Keep pressing the button until the required quantity is in the glass.

### Dispensing ice

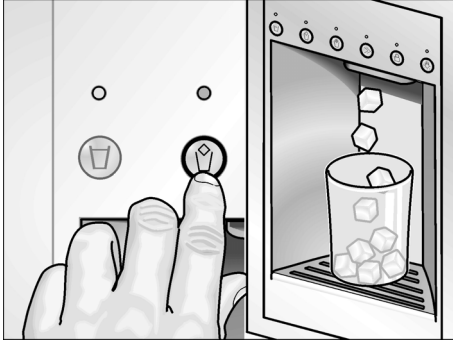

### Dispensing water

#### Notes

- The water from the water dispenser is cooled to a palatable temperature. If you would like the water colder, place ice cubes in the glass before dispensing the water.
- When dispensing fairly large amounts of water, the dispensed water may become warmer.

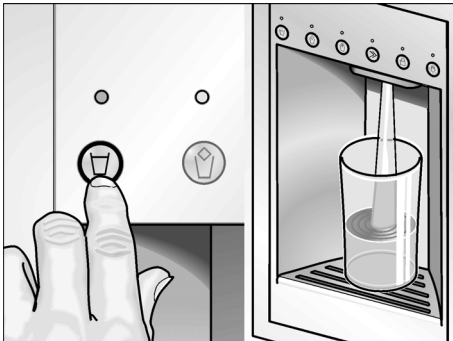

## Dispensing ice and water

#### Notes

- To prevent the ice from falling on the floor, hold the glass directly under the dispenser when dispensing crushed ice.
  - To prevent water damage, the water dispenser automatically stops after 30 seconds of continuous dispensing. If you want to dispense more water, wait 5 seconds and press the button again.
  - The dispensed water is cooled to a palatable temperature. To obtain a colder drinking temperature, put more ice cubes in the glass.
  - The water may become warmer when dispensing fairly large amounts of water.
1. Hold the glass under the ice and water dispenser.
  2. Keep pressing the dispensing button until the required quantity of ice or water is in the glass.

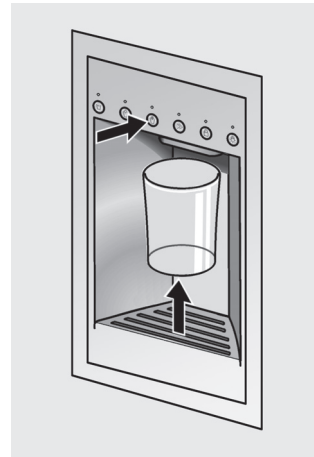

---

## Interior fittings

---

### Taking out the shelves

You can reposition the shelves inside the appliance and the door shelves as required.

Lift the shelves and remove.

#### Shelves inside the compartment

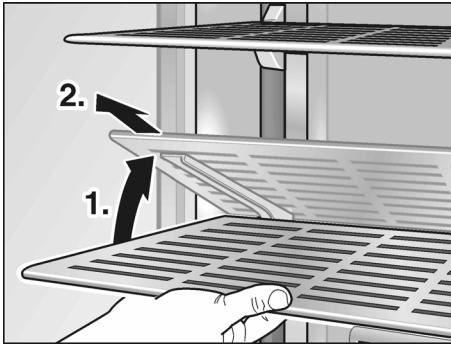

#### Door shelves

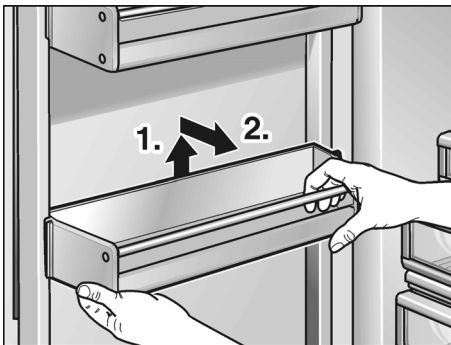

### Containers in the freezer compartment

The containers in the freezer compartment can be taken out for cleaning.

1. Lift container slightly and take out.

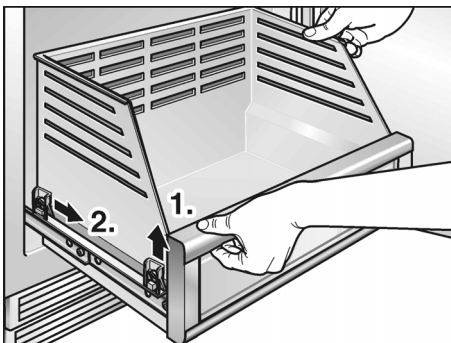

2. Lift container at front slightly and insert into the pullouts.
3. Lower container and push back.

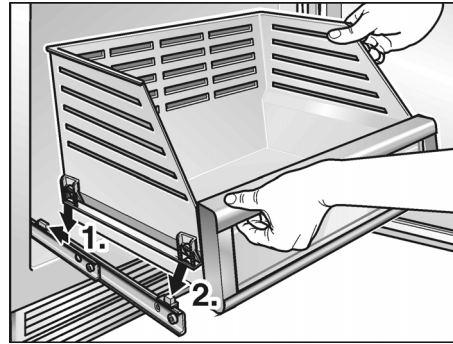

---

## Switching off and disconnecting the appliance

---

### Switching the appliance off

Press the On/Off button ①.

Pull out the mains plug.

### Disconnecting the appliance

If you do not use the appliance for a prolonged period:

1. Before switching off, it is most important that you switch the water supply to the appliance off for a few hours.
2. Take all food out of the appliance.
3. Switch the appliance off.
4. Pull out mains plug or switch off fuse.
5. Empty and clean the ice cube container (see chapter Cleaning the appliance).
6. Clean the appliance interior (see chapter Cleaning the appliance).
7. Leave the appliance doors open to prevent odours from forming.

---

## Defrosting

---

Defrosting is actuated automatically.

---

## Cleaning the appliance

---

### Warning

Never clean the appliance with a steam cleaner!

### Caution

- Do not use abrasive, chloride or acidic cleaning agents or solvents.
- Do not use scouring or abrasive sponges. The metallic surfaces could corrode.
- Never clean shelves and containers in the dishwasher. The parts may become deformed!

### Proceed as follows:

1. Before cleaning: Switch off the appliance.
2. Pull out mains plug or switch off fuse.
3. Take out the frozen food and store in a cool location. Place the ice pack (if enclosed) on the food.
4. Wait until the layer of frost has thawed.
5. Clean the appliance with a soft cloth, lukewarm water and a little pH neutral washing-up liquid. The rinsing water must not run into the light.
6. Wipe the door seal with clear water only and then wipe dry thoroughly.
7. After cleaning reconnect and switch the appliance back on.
8. Put the frozen food back into the appliance.

### Interior fittings

All variable parts of the appliance can be taken out for cleaning (see chapter Interior fittings).

#### Cleaning the ice cube container

If ice cubes have not been dispensed for a prolonged period, they will shrink, have a stale taste and stick together. Therefore, the ice cube container should be cleaned regularly.

### Caution

A full ice cube container is heavy.

1. Switch off ice maker (see chapter Switching off the ice maker).
2. Remove the ice cube container.

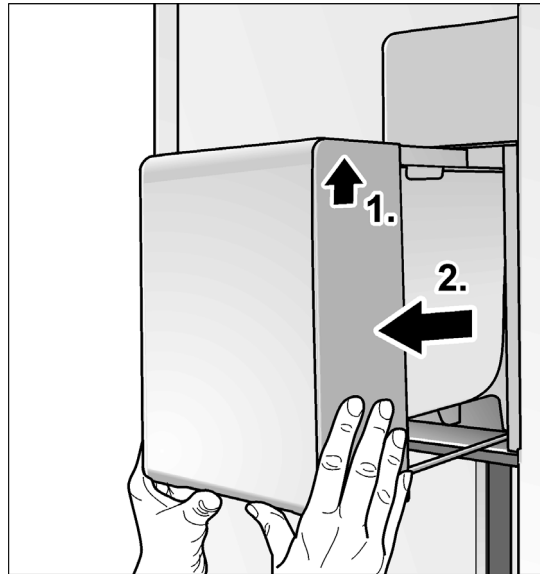

3. Empty the container and clean with lukewarm water.
4. Rub the container and screw conveyor dry so that new ice cubes cannot freeze to them.
5. Insert ice cube container and push back until it engages. If the container cannot be pushed all the way back, twist the screw conveyor in the container.

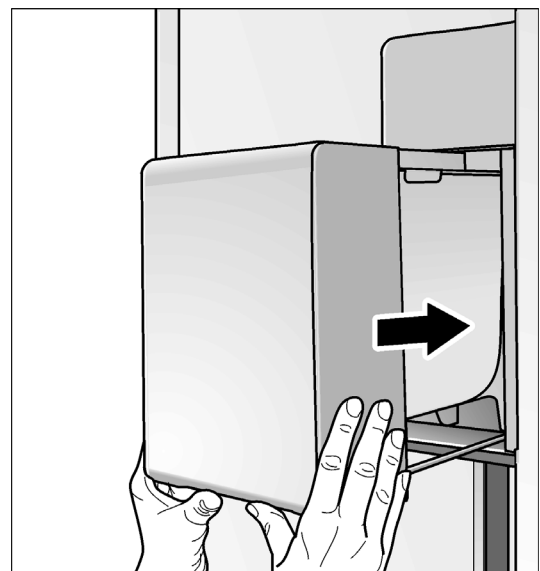

6. Switch on the ice maker – ice cube production starts.

---

## Light (LED)

---

Your appliance features a maintenance-free LED light.

These lights may be repaired by customer service or authorised technicians only.

---

## Tips for saving energy

---

- Install the appliance in a dry, well ventilated room! The appliance should not be installed in direct sunlight or near a heat source (e.g. radiator, cooker).  
If required, use an insulating plate.
- Do not block the ventilation openings in the appliance.
- Allow warm food and drinks to cool down before placing in the appliance.
- Thaw frozen food in the refrigerator compartment and use the low temperature of the frozen food to cool refrigerated food.
- Open the appliance as briefly as possible.
- Ensure that the freezer compartment door is always closed properly.
- The arrangement of the fittings does not affect the energy rating of the appliance.

---

## Operating noises

---

### Quite normal noises

#### Droning

Motors are running (e.g. refrigerating units, fan).

#### Bubbling, humming or gurgling noises

Refrigerant is flowing through the tubing or water is flowing into the ice maker.

#### Clicking

Motor, switches or solenoid valves are switching on/off.

#### Rumbling

Ready ice cubes from the ice maker are falling into the ice cube container.

## Preventing noises

### The appliance is not level

Please align the appliance with a spirit level. Use the height-adjustable feet or place packing underneath them.

### The appliance is not free-standing

Please move the appliance away from adjacent units or appliances.

### Containers or storage areas wobble or stick

Please check the removable parts and re-insert them correctly if required.

### Bottles or receptacles are touching each other

Move the bottles or receptacles slightly away from each other.

## Eliminating minor faults yourself

Before you call customer service:

Please check whether you can eliminate the fault yourself based on the following information.

Customer service will charge you for advice – even if the appliance is still under guarantee!

<b>Fault</b>	<b>Possible cause</b>	<b>Remedial action</b>
Appliance has no refrigeration capacity.	Appliance has been switched off.	Press the On/Off button.
	Power failure.	Check whether the power is on.
The light does not work.	The fuse has been switched off.	Check the fuse.
The display does not illuminate.	The mains plug has not been inserted properly.	Check whether the mains plug is secure.
The refrigeration unit is switching on more frequently and for longer.	Appliance opened frequently.	Do not open the appliance unnecessarily.
	The ventilation openings have been covered.	Remove obstacles.
	Large quantities of fresh food are placed in the freezer.	Activate fast freezing.
The light (LED) does not work.	The LED lamp is defective.	Call customer service.
	Light switch is jammed.	Check whether it can be moved.
Display indicates "E..".	Electronics have detected a fault.	Call customer service.
Display indicates "LOWPOWER".	The mains voltage falls below the permitted limiting value.	When the mains voltage reaches the stipulated value again, the warning message goes out. If the warning message lasts for longer, inform the energy supply company.
Display indicates "HIGHVOLT".	The mains voltage exceeds the permitted limiting value.	When the mains voltage reaches the stipulated value again, the warning message goes out. If the warning message lasts for longer, inform the energy supply company.

## Ice maker/ice and water dispenser

<b>Fault</b>	<b>Possible cause</b>	<b>Remedial action</b>
No water can be drawn, ice is however given out.	Fault with the appliance.	It is necessary to inform customer service!
Ice maker/ice and water dispenser does not work.	Ice maker is not connected to the mains supply.	Call customer service.
	Ice maker does not receive any fresh water.	Ensure that the water is properly connected.
	The freezer compartment temperature is too warm.	Check freezer compartment temperature and, if required, set slightly colder.
No water or ice is given out at the dispenser.	Childproof lock is activated.	Deactivate the lock.
	Water tank fills itself up.	When first used, it takes approx. 2 minutes until the water tank is filled.
	The appliance or ice maker has only just been switched on.	Approx. 24 hours is needed until ice production starts.
	A lot of ice has been taken.	Approx. 24 hours is needed until the ice cube container is filled.
	Low water pressure.	Connect the appliance to the stipulated water pressure only (see chapter Connecting the appliance, section Water connection).
	Screen on the water supply is dirty.	Call customer service.
The ice maker does not make enough ice or the ice is deformed.	The appliance or ice maker has only just been switched on.	Approx. 24 hours is needed until ice production starts.
	A lot of ice has been taken.	Approx. 24 hours is needed until the ice cube container is filled again.
	Low water pressure.	Connect the appliance to the stipulated water pressure only (see chapter "Connecting the appliance", section "Water connection").
	Screen on the water supply is dirty.	Call customer service.
	Temperature in the freezer compartment is too warm.	Set temperature slightly colder in the freezer compartment.
	Ice cubes have accumulated on the rear panel of the ice cube container.	Distribute ice cubes in the ice cube container. If ice cubes are stuck to each other, loosen with a blunt implement.
The ice maker does not make any ice.	Screen on the water supply is dirty.	Call customer service.
	The ice maker is switched off.	Switch the ice maker on at the control panel.
	The appliance is not supplied with water.	Contact the installer or the water supply company.
	Water supply has kinks.	Turn off the water supply at the shut-off valve. Smoothen out the kinks, exchange where necessary.
	Low water pressure.	Connect the appliance to the stipulated water pressure only (see chapter Connecting the appliance, section Water connection).
	Temperature in the freezer compartment is too warm.	Set temperature slightly colder in the freezer compartment.
	Ice cube container is not properly inserted.	Check the position, re-insert where necessary.
The illumination on the dispenser unit does not work.	Incorrect shut-off valve installed.	Incorrect valves can cause low water pressure and damage to the appliance.
	The permanent light function is deactivated.	Press the light button in order to switch the permanent light function on.
Ice forms in the inflow hose to the ice maker.	The light is defective.	See chapter "Light (LED)".
	Low water pressure.	Connect the appliance to the stipulated water pressure only (see chapter Connecting the appliance, section Water connection).
	Shut-off valve incorrectly opened.	Open shut-off valve fully.

<b>Fault</b>	<b>Possible cause</b>	<b>Remedial action</b>
Water runs from the appliance.	The water connection hose is not properly sealed.	Replace the hose with a manufacturer's original part.
	Incorrect shut-off tap installed.	Incorrect taps can cause low water pressure and damage to the appliance.
The water pressure is less than usual.	Low water pressure.	Connect the appliance to the stipulated water pressure only (see chapter Connecting the appliance, section Water connection).
	Shut-off valve incorrectly opened.	Open shut-off valve fully and check for leaks. Check the minimum through flow.
	Incorrect shut-off valve installed.	Incorrect valves can cause low water pressure and damage to the appliance.
	Water supply has kinks.	Turn off the water supply at the shut-off valve. Smoothen out the kinks, exchange where necessary.
	Screen on the water supply is dirty.	Call customer service.

---

## Customer service

---

Your local customer service can be found in the telephone directory or in the customer-service index. Please provide customer service with the appliance product number (E-Nr.) and production number (FD).

These specifications can be found on the rating plate.

To prevent unnecessary call-outs, please assist customer service by quoting the product and production numbers. This will save you additional costs.

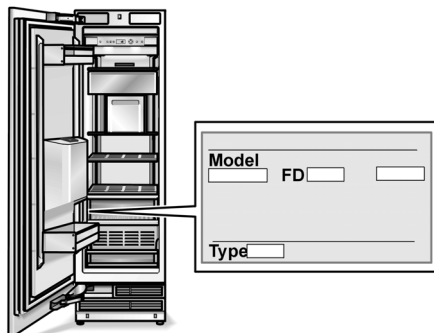

## Repair order and advice on faults

Contact information for all countries can be found on the enclosed customer service list.

GB	0344 892 8988	Calls charged at local or mobile rate.
IE	01450 2655	0.03 € per minute at peak. Off peak 0.0088 € per minute.
US	877 442 4436	toll-free



**Gaggenau Hausgeräte GmbH**  
Carl-Wery-Straße 34  
D-81739 München  
[www.gaggenau.com](http://www.gaggenau.com)

en (9708) 9000909130



**GAGGENAU**