

RC 462

RC 462AU

RC 472

Refrigerator

en Table of Contents

Safety and warning information	3	Refrigerator compartment	11
Information concerning disposal	4	Fast cooling	11
Scope of delivery	4	“Cool-fresh” container	12
Installing the appliance	5	Interior fittings	13
Ambient temperature and ventilation	5	Switching off and disconnecting the appliance	14
Connecting the appliance	5	Defrosting	14
Getting to know your appliance	6	Cleaning the appliance	14
Switching the appliance on	8	Odours	14
Set the language	8	Light (LED)	15
Setting the temperature unit	8	Tips for saving energy	15
Setting the temperature	8	Operating noises	15
Special functions	9	Eliminating minor faults yourself	16
Alarm function	10	Customer service	17
Usable capacity	10		

Safety and warning information

Before you switch ON the appliance

Please read the operating and installation instructions carefully! They contain important information on how to install, use and maintain the appliance.

The manufacturer is not liable if you fail to comply with the instructions and warnings. Retain all documents for subsequent use or for the next owner.

Technical safety

The appliance contains a small quantity of environmentally friendly but flammable refrigerant R600a. Ensure that the tubing of the refrigerant circuit is not damaged during transportation and installation. Leaking refrigerant may cause eye injuries or ignite.

If damage has occurred

- Keep naked flames and/or ignition sources away from the appliance,
- thoroughly ventilate the room for several minutes,
- switch off the appliance and pull out the mains plug,
- inform customer service.

The more refrigerant an appliance contains, the larger the room must be in which the appliance is situated. Leaking refrigerant can form a flammable gas-air mixture in rooms which are too small.

The room must be at least 1 m³ per 8 g of refrigerant. The amount of refrigerant in your appliance is indicated on the rating plate inside the appliance.

If the power cord of this appliance is damaged, it must be replaced by the manufacturer, customer service or a similarly qualified person. Improper installations and repairs may put the user at considerable risk.

Repairs may be performed by the manufacturer, customer service or a similarly qualified person only.

Only original parts supplied by the manufacturer may be used. The manufacturer guarantees that only these parts satisfy the safety requirements.

A extension cable may be purchased from customer service only.

Important information when using the appliance

- Never use electrical appliances inside the appliance (e.g. heater, electric ice maker, etc.). Explosion hazard!
- Never defrost or clean the appliance with a steam cleaner! The steam may penetrate electrical parts and cause a short-circuit. Risk of electric shock!
- Do not use pointed or sharp-edged implements to remove frost or layers of ice. You could damage the refrigerant tubes. Leaking refrigerant may cause eye injuries or ignite.
- Do not store products which contain flammable propellants (e.g. spray cans) or explosive substances in the appliance. Explosion hazard!
- Do not stand on or lean heavily against base of appliance, drawers or doors, etc
- For defrosting and cleaning, pull the mains plug out or switch off the fuse. Do not pull out the mains plug by tugging on the power cord.
- Store high-percentage alcohol tightly closed and standing up.
- Keep plastic parts and the door seal free of oil and grease. Otherwise, parts and door seal will become porous.
- Never cover or block the ventilation openings of the appliance!
- **Avoiding placing children and vulnerable people at risk:**
At risk are children, people who have limited physical, mental or sensory abilities, as well as people who have inadequate knowledge concerning safe operation of the appliance. Ensure that children and vulnerable people have understood the hazards. A person responsible for safety must supervise or instruct children and vulnerable people who are using the appliance.

Only children from 8 years and above may use the appliance.
Supervise children who are cleaning and maintaining the appliance.
Never allow children to play with the appliance.

Children in the household

- Keep children away from packaging and its parts.
Danger of suffocation from folding cartons and plastic film!
- Do not allow children to play with the appliance!
- If the appliance features a lock: keep the key out of the reach of children!

General regulations

The appliance is suitable for refrigerating food.

This appliance is intended for use in the home and the home environment.

The appliance is suppressed according to EU Directive 2004/108/EC.

The refrigeration circuit has been checked for leaks.

This product complies with the relevant safety regulations for electrical appliances (EN 60335-2-24).

This appliance is intended for use up to a maximum height of 2000 metres above sea level.

Information concerning disposal

Disposal of packaging

The packaging protects your appliance from damage during transit. All utilised materials are environmentally safe and recyclable. Please help us by disposing of the packaging in an environmentally friendly manner.

Please ask your dealer or inquire at your local authority about current means of disposal.

Disposal of your old appliance

Old appliances are not worthless rubbish! Valuable raw materials can be reclaimed by recycling old appliances.



This appliance is labelled in accordance with European Directive 2012/19/EU concerning used electrical and electronic appliances (waste electrical and electronic equipment - WEEE). The guideline determines the framework for the return and recycling of used appliances as applicable throughout the EU.

Warning

Redundant appliances

1. Pull out the mains plug.
2. Cut off the power cord and discard with the mains plug.
3. Do not take out the trays and receptacles: children are therefore prevented from climbing in!
4. Do not allow children to play with the appliance once it has spent its useful life. Danger of suffocation!

Refrigerators contain refrigerant and gases in the insulation. Refrigerant and gases must be disposed of professionally. Ensure that tubing of the refrigerant circuit is not damaged prior to proper disposal.

Scope of delivery

After unpacking all parts, check for any damage in transit.

If you have any complaints, please contact the dealer from whom you purchased the appliance or our customer service.

The delivery consists of the following parts:

- Built-in appliance
- Interior fittings (depending on model)
- Bag containing installation materials
- Operating instructions
- Installation manual
- Customer service booklet
- Warranty enclosure
- Information on the energy consumption and noises

Installing the appliance

Have a technician install and connect the appliance according to the enclosed installation instructions.

Transporting

The appliance is heavy. Secure in position during transportation and installation.

Due to the weight/dimensions of the appliance and to minimise the risk of injury and damage to the appliance at least two persons are necessary to set-up the appliance safely.

Installation location

A dry, well ventilated room is suitable as an installation location. The installation location should not be exposed to direct sunlight and not placed near a heat source, e.g. a cooker, radiator, etc. If installation next to a heat source is unavoidable, use a suitable insulating plate or observe the following minimum distances from the heat source:

- 3 cm to electric or gas cookers.
- 30 cm to an oil or coal-fired cooker.

The floor of the installation location must not give way; if required, reinforce floor.

Ambient temperature and ventilation

Ambient temperature

The climate class can be found on the rating plate. The climate class indicates within which ambient temperatures the appliance can be operated.

Climate class	Permitted ambient temperature
SN	+10 °C to 32 °C
N	+16 °C to 32 °C
ST	+16 °C to 38 °C
T	+16 °C to 43 °C

Note

The appliance is fully functional within the room temperature limits of the indicated climatic class. If an appliance of climatic class SN is operated at colder room temperatures, the appliance will not be damaged up to a temperature of +5 °C.

Ventilation

Conduction of the heated air must not be obstructed. Otherwise, the refrigeration unit must work harder. This increases power consumption. Therefore: Never cover or block the ventilation opening!

Connecting the appliance

Have a technician install and connect the appliance according to the enclosed installation instructions.

Do not remove the transportation protection devices from the shelves and storage compartments until the appliance has been installed.

In addition to the statutory national regulations, observe the connection conditions of the local power supply companies.

After installing the appliance, wait at least 1 hour until the appliance starts up. During transportation the oil in the compressor may have flowed into the refrigeration system.

Before switching on the appliance for the first time, clean the interior of the appliance (see chapter "Cleaning the appliance").

Electrical connection

The socket must be near the appliance and also freely accessible following installation of the appliance.

The appliance complies with the protection class I. Connect the appliance to 220-240 V/50 Hz alternating current via a correctly installed socket with protective conductor. The socket must be fused with a 10 to 16 A fuse.

For appliances operated in non-European countries, check whether the stated voltage and current type on the rating plate match the values of your mains supply. These specifications can be found on the rating plate (see chapter "Customer service").

Warning

Never connect the appliance to electronic energy saver plugs.

Our appliances can be used with mains and sine-controlled inverters. Mains-controlled inverters are used for photovoltaic systems which are connected directly to the national grid. Sine-controlled inverters must be used for isolated applications (e.g. on ships or in mountain lodges) which are not connected directly to the national grid.

Getting to know your appliance

These operating instructions refer to several models. The diagrams may differ.

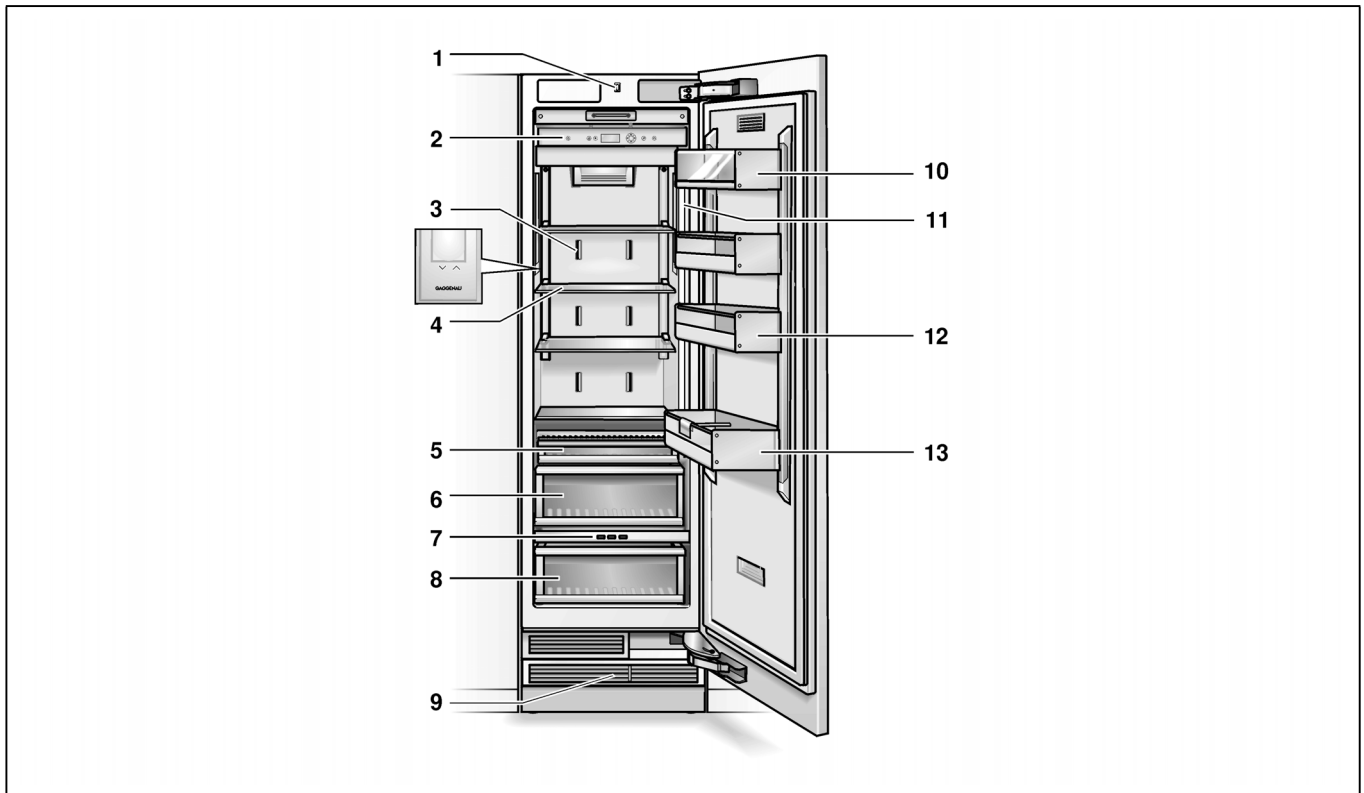

- 1 Light switch
- 2 Controls
- 3 Air outlet opening
- 4 Motorised compartment
- 5 Snack-Box
- 6 Fruit and vegetable container
- 7 Selection buttons "cool-fresh" container
- 8 "Cool-fresh" container
- 9 Ventilation
- 10 Butter and cheese compartment
- 11 Light (LED)
- 12 Door shelf
- 13 Storage compartments for large bottles

Controls

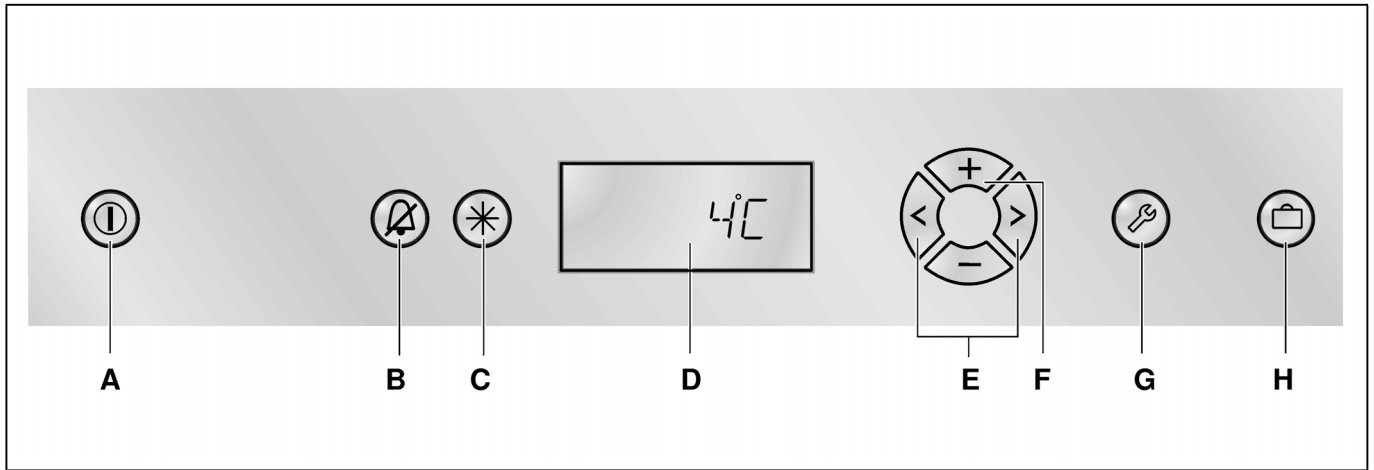

- A On/Off button**

Serves to switch the whole appliance on and off.

- B Alarm button**

Used to switch off the warning signal, (see chapter Alarm function).

- C Fast cooling button**

Switches fast cooling on and off, see chapter Fast cooling.

- D Display panel**

The temperatures in the refrigerator compartment are shown in the display panel. Activated special functions are shown via “symbol”.

The menus and setting options which are available are represented on the display panel in the setup mode, see chapter “Special functions”.

- E Selection buttons**

The temperature setting is activated using the selection buttons (see chapter Setting the temperature).

For selecting a menu in the setup mode (see chapter Special functions).

- F Setting buttons**

The temperature can be changed using the setting buttons (see chapter “Setting the temperature”).

More settings can be selected in the setup mode, (see chapter “Special functions”).

- G “setup” button**

This button starts and ends the setup mode. If the setup mode is ended using the setup button, the changes which have been made are stored.

- H Holiday button**

Is used to switch holiday mode on and off, (see chapter Special functions, section Holiday mode).

Note

A sound can be heard every time a button is actuated if this function is activated in the sound menu during the setup mode.

Symbols in the display field

- Fast cooling is activated (see chapter “Fast cooling”).
- Holiday mode is activated, see chapter Special functions.
- A warning message is displayed, see chapter Alarm function.

Switching the appliance on

Switch on the appliance with the On/Off button ①.

The appliance begins to cool. Light is switched on when the door is open.

Operating tips

- When the appliance has been switched on, it may take several hours until the set temperature has been reached.
- The fully automatic NoFrost system ensures that the refrigerator compartment remains free of ice. Defrosting is not required.

Set the language

The display languages can be changed according to the table in the chapter "Special functions", "Setup mode".

In order to change the display language:

1. Press setup button ②.
2. Press the < or > setting button, until the set language is displayed.
3. Press the + or - setting button, until the desired language is displayed.
4. Press the setup button ②, in order to store the settings. The set temperature is displayed again in the fascia.

Setting the temperature unit

The temperature can be displayed in degrees Celsius (°C) or degrees Fahrenheit (°F).

1. Press setup button ②.
The first menu (temperature unit) is displayed.
2. Press the + or - setting button in order to switch between degrees Fahrenheit (°F) and degrees Celsius (°C).
3. Press the setup button ②, in order to store the settings.
The set temperature is displayed again in the fascia.

Setting the temperature

Refrigerator compartment

(can be selected from +2 °C to +8 °C)

We recommend a setting of +4 °C.

Perishable food should not be stored above +4 °C.

1. Activate the setup mode with the selection button >. The symbol **REFRIGERATOR** is displayed.
2. Set the temperature with the + (warmer) or - (cooler) setting buttons.

Special functions

The following special functions can be selected or displayed:

Setup mode

In Setup mode you can make your personal settings.

Switching on

Press setup button .

The first menu (temperature unit) is displayed in the fascia.

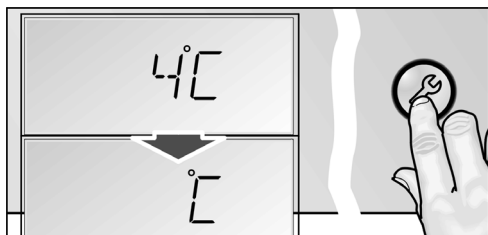

Making settings

1. Switch on setup mode.
2. Press the selection button < or >.
The next menu is displayed and its current setting (mostly **ON** or **OFF**).

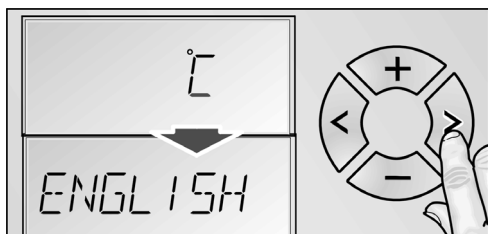

3. Press the setting button + or -.
The setting is saved, if the next menu is selected using < or >.

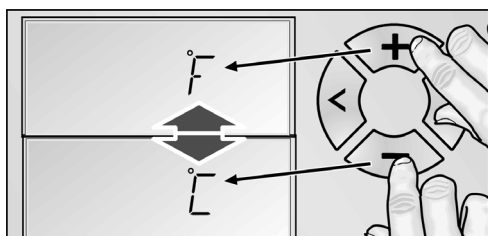

Switching off

Press setup button .

All of the changed settings are stored.

Note

If no button is selected within 20 seconds, the setup mode ends automatically. All of the changed settings are stored. The set temperature is displayed again in the fascia.

Menus in the setup mode

The following settings can be made.

Menu	Possible setting
Temperature unit	°C (degrees Celsius)
	°F (degrees Fahrenheit)
Language	Deutsch
	English
	French
	Danish
	Finnish
	Greek
	Dutch
	Italian
	Polish
	Portuguese
	Norwegian
Russian	
Swedish	
Spanish	
Turkish	
Czech	
Sound	On
	Off
Energy saving mode (eco function)	On
	Off

Holiday mode

If leaving the appliance for a long period of time, you can switch the appliance over to the energy-saving holiday mode.

When Vacation mode is switched on, the following settings are made:

- The appliance works in energy saving mode
- The illumination is switched off
- Fast cooling or fast freezing is then ended (if activated)

Switching on

Press Holiday button .

VACATION is displayed in the display panel.

Switching off

Press Holiday button .



The previous settings and temperature values are once again activated.

Rest mode

When Rest mode is switched on, the following settings are switched off:

- Acoustic signal
- Interior light
- Messages on the display panel
- The background illumination of the display panel is reduced
- Buttons are locked

Switching on

1. Press the fast cooling button  and keep it held down.
2. Press Holiday button .
3. Hold the fast cooling button  down for 3 seconds longer.
The symbol **VACATION** flashes on the display panel and **RESTMODE** is displayed.

Switching off





Press Holiday button .

The previous settings and temperature values are once again activated.





Energy saving mode

If the energy saving function (eco function) is activated, the appliance switches to energy saving operation. This energy saving function is preset at the factory in order to reduce energy consumption. The background illumination of the fascia is likewise reduced.

Switching on

1. Press setup button .
2. Press the selection button , until **ECO MODE** and the current setting (**OFF**) is displayed.
3. Press the setting button , in order to reset the setting.
4. Press the setup button , in order to store the setting.
ECO is displayed in the fascia.

Switching off

1. Press setup button .
2. Press the selection button , until **ECO MODE** and the current setting (**ON**) is displayed.
3. Press the setting button , in order to reset the setting.
4. Press the setup button , in order to store the setting.

Alarm function

Switching off the warning signal

Press the alarm button  to switch off the warning signal.

Door alarm

The door alarm switches on if an appliance door is left open for longer than three minutes. Close the door to switch off the warning signal.

Usable capacity

Information on the usable capacity can be found inside your appliance on the rating plate (see diagram at chapter "Customer service").

Refrigerator compartment

The refrigerator compartment is the ideal storage location for ready meals, cakes and pastries, preserved food, condensed milk, hard cheese, fruit and vegetables sensitive to cold as well as tropical fruit.

When purchasing food, please note:

The “purchase freshness” is important for the shelf-life of your food.

In principle, the following applies: the fresher you store the food in the appliance, the longer it will remain fresh.

Therefore, when buying food, pay attention to the degree of freshness.

In the case of ready-made products and bottled goods, observe the best-before date or use-by date specified by the manufacturer.

Arranging food in the appliance

- Wrap or cover food before placing in the appliance. This will retain the aroma, colour and freshness of the food. In addition, flavours will not be transferred between foods and the plastic parts will not become discoloured.
- Allow warm food and drinks to cool down before placing in the appliance.
- Do not block air outlet openings with food in the refrigerator compartment, otherwise the air circulation will be impaired. Food which is stored directly in front of the air outlet openings may be frozen by the cold air flowing out.
- Avoid contact of oil and fat with the plastic parts and door seal.

Fast cooling

Fast cooling sets the refrigerator temperature to the coldest temperature setting for approx. 6 hours. Then the original temperature set before fast cooling mode is automatically restored.

Switch on fast cooling mode, e.g.:

- before placing large quantities of food in the refrigerator compartment.
- for fast cooling drinks.

Switching on

Press fast cooling button .

The display panel indicates the symbol **SUPER**  and the compartment for which the function was switched on.



Switching off

Press fast freezing button .

“Cool-fresh” container

The temperature in the “cool-fresh” container is about 0 °C. The “cool-fresh” drawer is covered by a special filter which sets the ideal humid climate.

The low temperature and the optimum moisture provide ideal storage conditions for fresh food.

Food can be kept fresh up to three times longer than in the normal cooling zone – for even longer freshness, nutrient retention and flavour.

Selection buttons for “cool-fresh” container

Press the appropriate button corresponding to the food stored:

- Fish
For the storage of fish and seafood.
- Meat/poultry
For the storage of meat products, poultry, sausage and prepared meals.
- Vegetables
For the storage of fruit, vegetables, mushrooms and herbs.

The selection is displayed by illumination of the corresponding button.



Foods suitable for “cool-fresh” container:

In principle all foods which are fresh and are to remain fresh for even longer, such as: fish, seafood, meat and sausage, dairy products, and ready meals.

Foods not suitable for the “cool-fresh” drawer:

Fruit and vegetables sensitive to cold (e.g.: tropical fruit such as pineapples, bananas, papaya, citrus fruits, melons as well as tomatoes, aubergines, zucchini, capsicums, cucumbers, potatoes).

The ideal storage location for these foods is the refrigerator compartment.

When purchasing food, please note:

The “purchase freshness” is important for the shelf-life of your food.

In principle, the following applies: the fresher you store the food in the appliance, the longer it will remain fresh.

Therefore, when buying food, pay attention to the degree of freshness.

In the case of ready-made products and bottled goods, observe the best-before date or use-by date specified by the manufacturer.

Interior fittings

Taking out the shelves

You can reposition the shelves inside the appliance and the door shelves as required.

Lift the shelves and remove.

Shelves inside the compartment

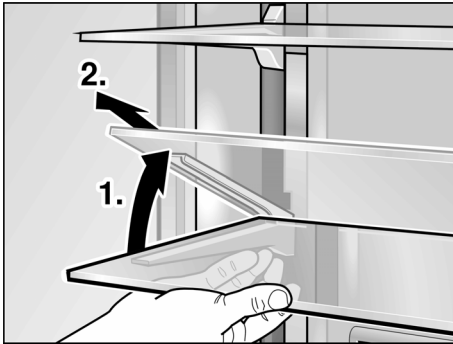

Door shelves

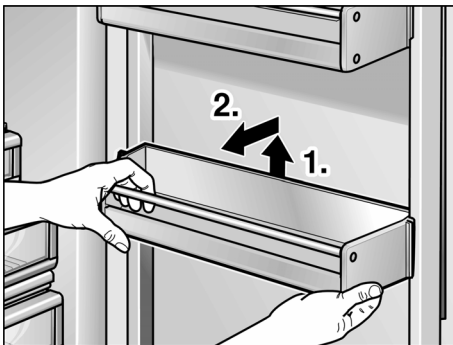

Bottle holder

The bottle holder prevents bottles from falling over when the door is opened and closed.

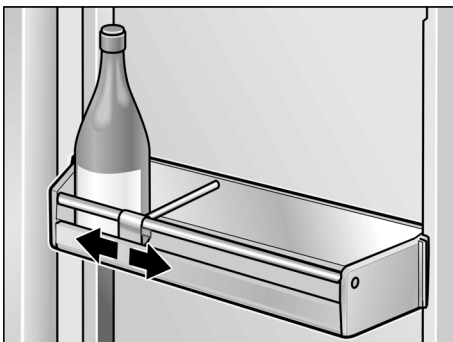

Containers in the refrigerator compartment

1. Lift container slightly and take out.

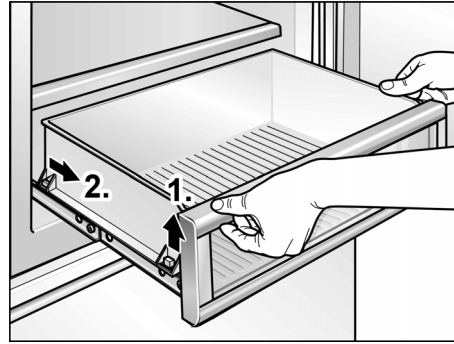

2. Lift container at front slightly and insert into the pullouts.
3. Lower container and push back.

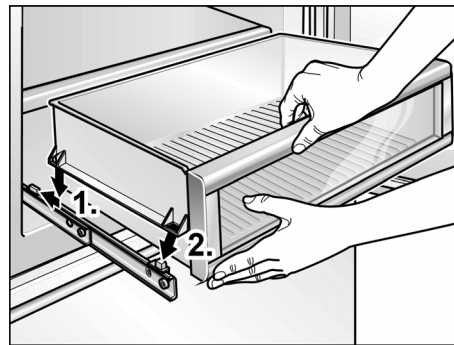

Removing the humidity filter in the “cool-fresh” container

Take out the “cool-fresh” container first. Then, pull out the humidity filter.

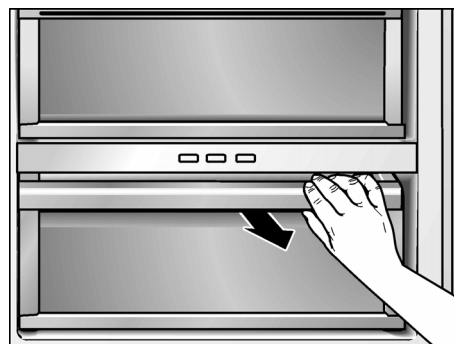

Lift off the filter cover and take out the filter.

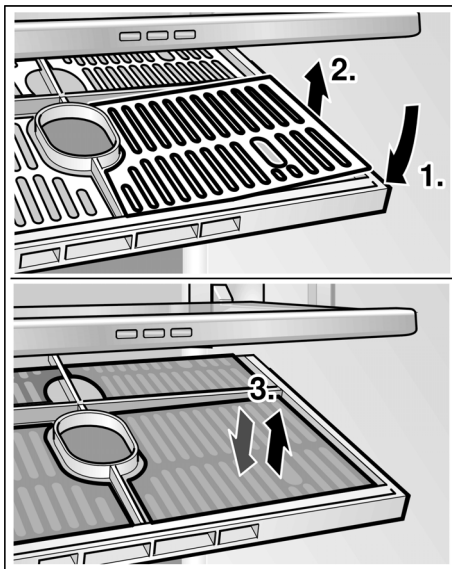

Switching off and disconnecting the appliance

Switching the appliance off

Press the On/Off button ①.

Refrigeration unit and light switch off.

Disconnecting the appliance

If you do not use the appliance for a prolonged period:

1. Switch off the appliance.
2. Pull out mains plug or switch off fuse.
3. Clean the appliance.
4. Leave the appliance door open.

Defrosting

Defrosting is actuated automatically.

Cleaning the appliance

⚠ Caution

- Do not use abrasive, chloride or acidic cleaning agents or solvents.
- Do not use scouring or abrasive sponges. The metallic surfaces could corrode.
- Never clean shelves and containers in the dishwasher. The parts may become deformed!

Proceed as follows:

1. Before cleaning: Switch off the appliance.
2. Pull out the mains plug or switch off the fuse!
3. Take out the food and store in a cool location.
4. Wait until the layer of frost has thawed.
5. Clean the appliance with a soft cloth, lukewarm water and a little pH neutral washing-up liquid. The rinsing water must not run into the light.
6. Wipe the door seal with clear water only and then wipe dry thoroughly.
7. Rinsing water must not run through the drainage hole into the evaporation area.
8. After cleaning reconnect and switch the appliance back on.
9. Put the food back into the appliance.

Interior fittings

All variable parts of the appliance can be taken out for cleaning (see chapter "Interior fittings").

Odours

If you experience unpleasant odours:

1. Switch the appliance off.
2. Take all food out of the appliance.
3. Clean interior (see chapter "Cleaning the appliance").
4. Clean all packages.
5. Seal strong smelling food in order to avoid odours from forming.
6. Switch the appliance on again.
7. Store food in the appliance.
8. Check whether the formation of odours is still occurring after 24 hours.
9. Change odour filter (see chapter "Exchange the odour filter").

Exchange the odour filter

Spare filters are available from your dealer.

1. Open the filter holder.

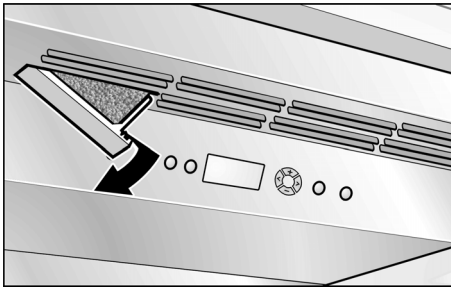

2. Remove the used odour filter and replace with a new odour filter.

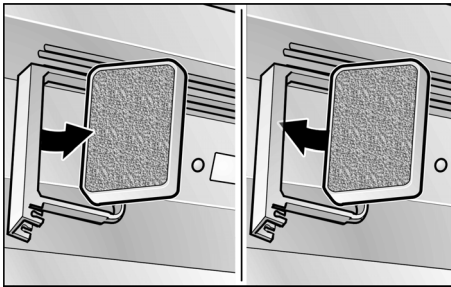

3. Close the filter holder.

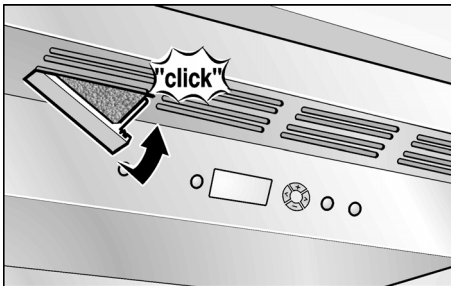

Light (LED)

Your appliance features a maintenance-free LED light.

These lights may be repaired by customer service or authorised technicians only.

Tips for saving energy

- Install the appliance in a dry, well ventilated room! The appliance should not be installed in direct sunlight or near a heat source (e.g. radiator, cooker). If required, use an insulating plate.
- Do not block the ventilation openings in the appliance.
- Allow warm food and drinks to cool down before placing in the appliance.
- Thaw frozen food in the refrigerator compartment and use the low temperature of the frozen food to cool refrigerated food.
- Open the appliance as briefly as possible.
- The arrangement of the fittings does not affect the energy rating of the appliance.

Operating noises

Quite normal noises

Droning

Motors are running (e.g. refrigerating units, fan).

Bubbling, humming or gurgling noises

Refrigerant is flowing through the tubing.

Clicking

Motor, switches or solenoid valves are switching on/off.

Preventing noises

The appliance is not level

Please align the appliance with a spirit level. Use the height-adjustable feet or place packing underneath them.

The appliance is not free-standing

Please move the appliance away from adjacent units or appliances.

Containers or storage areas wobble or stick

Please check the removable parts and re-insert them correctly if required.

Bottles or receptacles are touching each other

Move the bottles or receptacles slightly away from each other.

Eliminating minor faults yourself

Before you call customer service:

Please check whether you can eliminate the fault yourself based on the following information.

Customer service will charge you for advice – even if the appliance is still under guarantee!

Appliance

Fault	Possible cause	Remedial action
Appliance has no refrigeration capacity.	Appliance has been switched off.	Press the On/Off button.
	Power failure.	Check whether the power is on.
The light does not work.	The fuse has been switched off.	Check the fuse.
The display does not illuminate.	The mains plug has not been inserted properly.	Check whether the mains plug is secure.
The refrigeration unit is switching on more frequently and for longer.	Appliance opened frequently.	Do not open the appliance unnecessarily.
	The ventilation openings have been covered.	Remove obstacles.
	Large quantities of fresh food are placed in the freezer.	Switch on fast cooling (see chapter Fast cooling).
The light (LED) does not work.	The LED lamp is defective.	Call customer service.
	Light switch is jammed.	Check whether it can be moved.
Display indicates "E..".	Electronics have detected a fault.	Call customer service.
Display indicates "LOWPOWER".	The mains voltage falls below the permitted limiting value.	When the mains voltage reaches the stipulated value again, the warning message goes out. If the warning message lasts for longer, inform the energy supply company.
Display indicates "HIGHVOLT".	The mains voltage exceeds the permitted limiting value.	When the mains voltage reaches the stipulated value again, the warning message goes out. If the warning message lasts for longer, inform the energy supply company.
The motorised compartment cannot be moved. There is a loud noise.	The compartment is overloaded (>10 kg).	When making adjustments, do not load the compartment with more than 10 kg.
	The load touches the top.	Move the compartment only as far as the height of the load permits.
The motorised compartment cannot be moved.	Holiday mode is switched on.	Switch holiday mode off.

Customer service

Your local customer service can be found in the telephone directory or in the customer-service index. Please provide customer service with the appliance product number (E-Nr.) and production number (FD-Nr.).

These specifications can be found on the rating plate.

To prevent unnecessary call-outs, please assist customer service by quoting the product and production numbers. This will save you additional costs.

Repair order and advice on faults

Contact information for all countries can be found on the enclosed customer service list.

GB	0344 892 8988	Calls charged at local or mobile rate.
IE	01450 2655	0.03 € per minute at peak. Off peak 0.0088 € per minute.
US	877 442 4436	toll-free

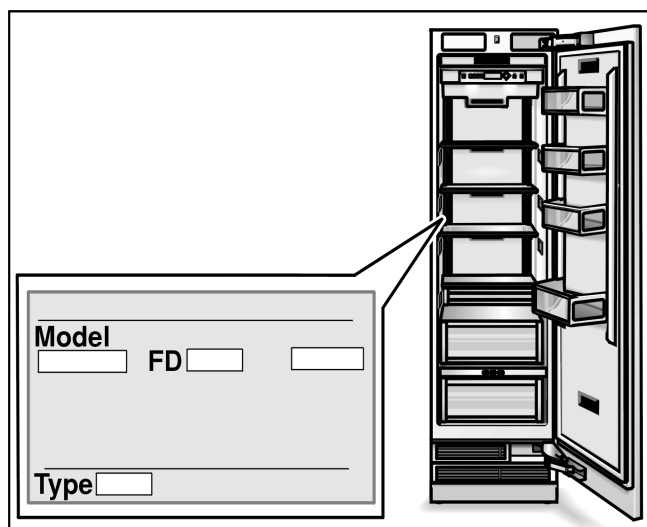

Gaggenau Hausgeräte GmbH
Carl-Wery-Straße 34
D-81739 München
www.gaggenau.com

en (9508) 9000909658



GAGGENAU