

BS 470/471 E

BS 474/475 E

Combi-steam oven

Table of contents

Important safety information	3	Long-term timer	21
Causes of damage	4	Setting the long-term timer	21
Environmental protection	5	Individual recipes	21
Environmental protection	5	Recording a recipe	21
Tips for saving energy	5	Entering names	22
Getting to know the appliance	6	Starting recipes	22
Steam oven	6	Deleting recipes	22
Display and operating controls	7	Core temperature probe	23
Symbols	7	Inserting the core temperature probe in the food to be cooked	23
Colours and display	8	Setting the core temperature	24
Automatic door opening	8	Recommended core temperature values	25
Additional information i and i [®]	8	Child lock	26
Cooling fan	8	Activate the child lock	26
Function selector positions	9	Deactivating the child lock	26
Accessories	11	Basic settings	27
Special accessories	11	Cleaning and maintenance	29
Before using for the first time	12	Cleaning agents	29
Setting the language	12	Cleaning programme	30
Setting the time format	12	Drying programme	30
Setting the clock	12	Descaling aid	31
Setting the date format	12	Removing slide-in rails	32
Setting the date	13	Trouble shooting	33
Setting the water filter	13	Power cut	34
Setting the water hardness	13	Demo mode	34
Ending initial set-up	13	Replacing the oven light	34
Calibration	14	After-sales service	34
Grease filter	14	Settings table and tips	35
Cleaning accessories	14	Vegetables	35
Water filter	15	Fish	36
Operation with or without a water filter	15	Fish – low-temperature steaming	37
Changing the water filter	15	Meat – cooking at higher temperatures	38
Activating the appliance	15	Meat/poultry – low-temperature cooking	39
Standby	15	Poultry	40
Activating the appliance	15	Side dishes	40
Operating the appliance	16	Desserts	41
Cooking compartment	16	Miscellaneous	41
Inserting accessories	16	Baking	42
Switching on	16	Regenerating (reheating)	43
Misting	17	Raising dough	43
Steam removal	17	Defrosting	44
After every use	17	Preserving	45
Safety shut-off	17	Extracting juice (soft fruit)	45
Timer functions	18	Preparing yoghurt	46
Calling up the timer menu	18	Preparing bulky food	46
Timer	18	Additional information on products, accessories, replacement parts and services can be found at www.gaggenau.com and in the online shop www.gaggenau-eshop.com	
Stopwatch	18		
Cooking time	19		
End of cooking time	20		

⚠ Important safety information

Read these instructions carefully. Only then will you be able to operate your appliance safely and correctly. Retain the instruction manual and installation instructions for future use or for subsequent owners.

This appliance is only intended to be fully fitted in a kitchen. Observe the special installation instructions.

Check the appliance for damage after unpacking it. Do not connect the appliance if it has been damaged in transport.

Only a licensed professional may connect appliances without plugs. Damage caused by incorrect connection is not covered under warranty.

This appliance is intended for domestic use only. The appliance must only be used for the preparation of food and drink. The appliance must be supervised during operation. Only use this appliance indoors.

This appliance may be used by children over the age of 8 years old and by persons with reduced physical, sensory or mental capabilities or by persons with a lack of experience or knowledge if they are supervised or are instructed by a person responsible for their safety how to use the appliance safely and have understood the associated hazards.

Children must not play with the appliance. Children must not clean the appliance or carry out general maintenance unless they are at least 8 years old and are being supervised.

Keep children below the age of 8 years old at a safe distance from the appliance and power cable.

Always slide accessories into the cooking compartment correctly. See description of accessories in the instruction manual.

Risk of fire!

- Combustible items stored in the cooking compartment may catch fire. Never store combustible items in the cooking compartment. Never open the appliance door if there is smoke inside. Switch off the appliance and unplug it from the mains or switch off the circuit breaker in the fuse box.
- A draught is created when the appliance door is opened. Greaseproof paper may come into contact with the heating element and catch fire. Do not place greaseproof paper loosely over accessories during preheating. Always weight down the greaseproof paper with a dish or a baking tin. Only cover the surface required with greaseproof paper. Greaseproof paper must not protrude over the accessories.

Risk of burns!

- The appliance becomes very hot. Never touch the interior surfaces of the cooking compartment or the heating elements. Always allow the appliance to cool down. Keep children at a safe distance.
- Accessories and ovenware become very hot. Always use oven gloves to remove accessories or ovenware from the cooking compartment.
- Alcoholic vapours may catch fire in the hot cooking compartment. Never prepare food containing large quantities of drinks with a high alcohol content. Only use small quantities of drinks with a high alcohol content. Open the appliance door with care.
- Hot steam may escape during operation. Do not touch the ventilation openings. Keep children away.

Risk of scalding!

- When you open the appliance door, hot steam can escape. Steam may not be visible, depending on its temperature. When opening, do not stand too close to the appliance. Open the appliance door carefully. Keep children away.
- Hot liquid may spill over the sides of cooking containers when they are removed from the cooking compartment. Remove hot cooking containers with care and always wear oven gloves.

Risk of electric shock!

- Incorrect repairs are dangerous. Repairs may only be carried out and damaged power cables replaced by one of our trained after-sales technicians. If the appliance is defective, unplug the appliance from the mains or switch off the circuit breaker in the fuse box. Contact the after-sales service.
- The cable insulation on electrical appliances may melt when touching hot parts of the appliance. Never bring electrical appliance cables into contact with hot parts of the appliance.
- Penetrating moisture may cause an electric shock. Do not use any high-pressure cleaners or steam cleaners.
- A defective appliance may cause electric shock. Never switch on a defective appliance. Unplug the appliance from the mains or switch off the circuit breaker in the fuse box. Contact the after-sales service.
- The insulation of an incompatible meat probe may be damaged. Only use the meat probe which is recommended for this appliance.

Causes of damage

Caution!

- Do not place anything on the cooking compartment floor. Do not cover it with aluminium foil. A build-up of heat could damage the appliance.
The cooking compartment floor must always be kept clear. Always place ovenware in a perforated cooking container or on a wire rack.
- Aluminium foil in the cooking compartment must not come into contact with the door panel. This could cause permanent discolouration of the door panel.
- We recommend you install a descaling system for hard mains water. You can inquire with your waterworks to obtain information about your mains water.
- Ovenware must be heat and steam resistant. Silicone baking tins are not suitable for combined operation with steam.
- Use only original accessories in the cooking compartment. Rusting material (such as serving platters or knives and forks) can cause corrosion in the oven interior.
- Use original small parts (e.g. knurled nuts) only. Order small parts from our after-sales service if these should be lost.
- When steaming with a perforated cooking container, always insert the baking tray or the solid cooking container underneath. Dripping liquid is caught.
- Do not store moist food in the closed cooking compartment for long periods. It can lead to corrosion in the cooking compartment.
- Salt, spicy sauces (e.g. ketchup or mustard) or salted dishes (e.g. cured roast) contain chloride and acids. These corrode the surfaces of stainless steel. Always remove residues immediately.
- Fruit juice may leave stains in the cooking compartment. Always remove fruit juice immediately and wipe the cooking compartment with a moist and dry cloth.
- The cooking compartment in your appliance is made of high grade stainless steel. Improper care can lead to corrosion in the cooking compartment. Refer to the care and cleaning instructions in the instruction manual. After every use, clean the cooking compartment after the appliance has cooled down. After cleaning, dry the cooking compartment with the drying program.
- Do not detach the door seal. The appliance door will no longer close properly if the door seal is damaged. The fronts of adjacent units could be damaged. Have the door seal replaced.
- Do not carry or hold the appliance by the door handle. The door handle cannot support the weight of the appliance, and could break.

Environmental protection

Unpack the appliance and dispose of the packaging in an environmentally-responsible manner.

Environmental protection



This appliance is labelled in accordance with the European Directive 2012/19/EU concerning used electrical and electronic appliances (WEEE – waste electrical and electronic equipment). The guideline determines the framework for the return and recycling of used appliances as applicable.

Tips for saving energy

- Open the appliance door as little as possible while cooking.
- Use dark, black lacquered or enamelled baking tins for baking. They absorb the heat particularly well.
- It is best to bake several cakes one after the other. The oven will still be hot. This reduces the baking time for the second cake. You can also place two loaf tins next to each other.
- For longer cooking times, you can switch off the steam oven 10 minutes before the end of the cooking time and you can use the residual heat to finish cooking.
- When steaming, you can cook simultaneously on several levels. If dishes require different cooking times, insert the dishes that require the longest time first.

Getting to know the appliance

Use this section to familiarise yourself with your new appliance. The control panel and the individual operating controls are explained. You will find information on the cooking compartment and the accessories.

Steam oven

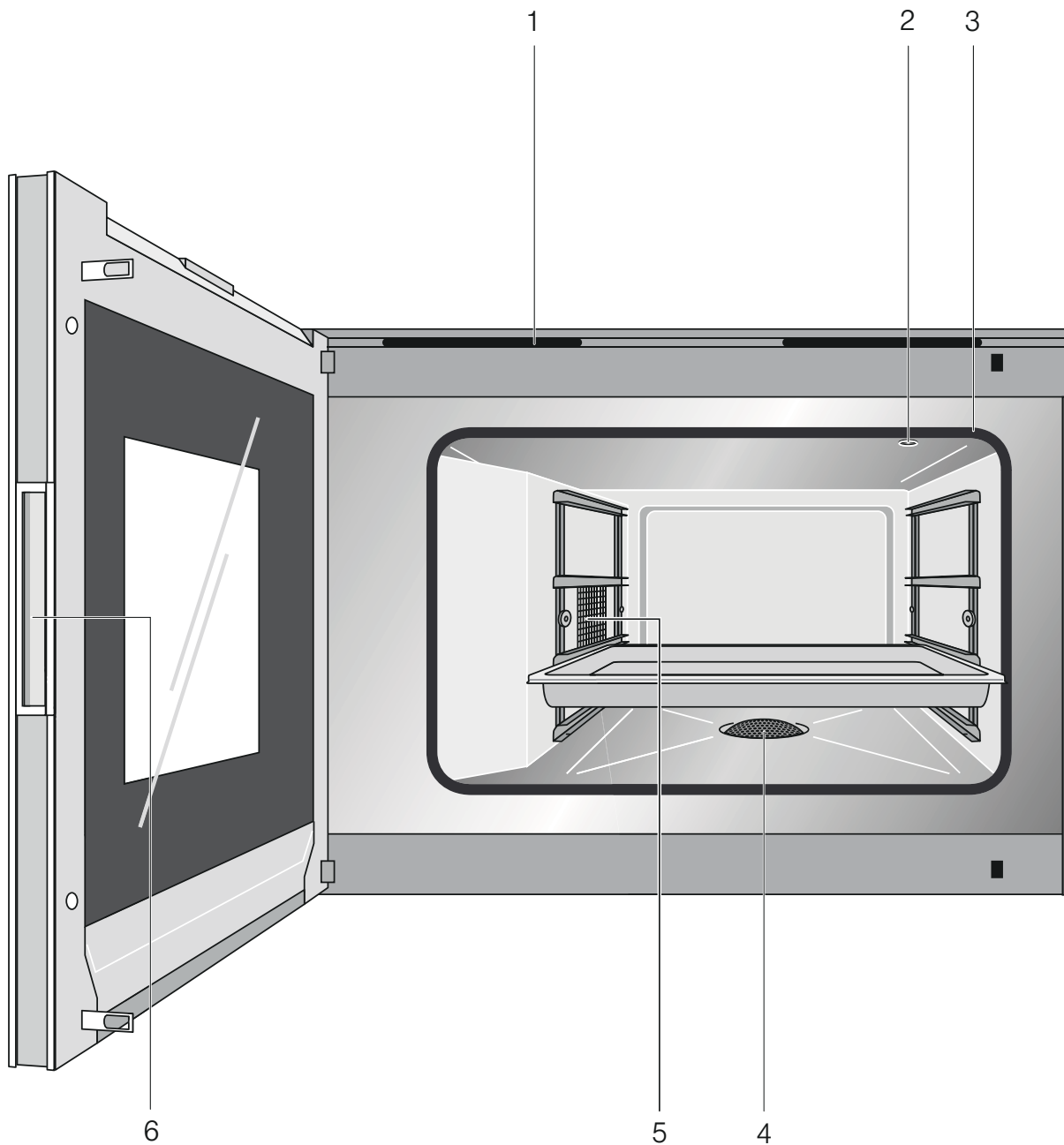

1	Ventilation opening
2	Socket for core temperature probe
3	Door seal
4	Strainer

5	Grease filter
6	Recessed handle

Display and operating controls

These instructions are valid for different versions of the appliance. Depending on the appliance model, some details may differ.

All versions of the appliance are operated in an identical manner.

Operating controls on the upper side of the appliance

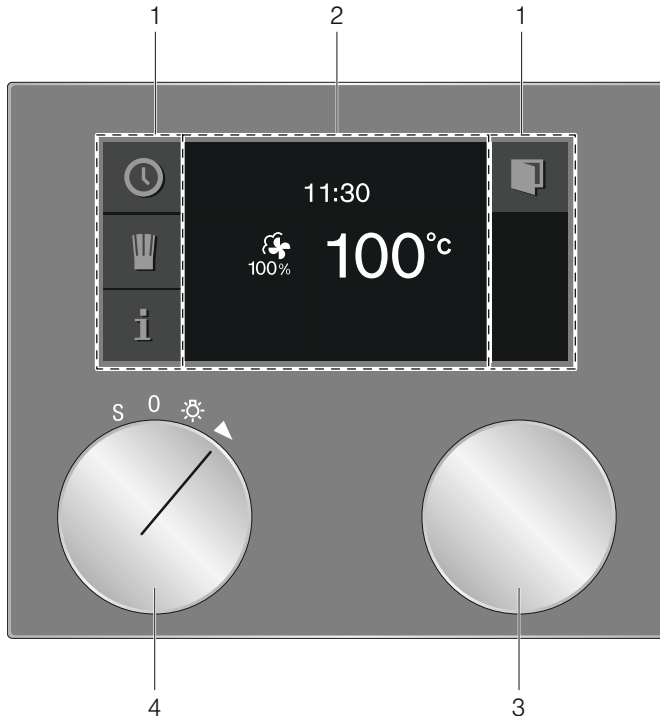

Operating controls on the lower side of the appliance

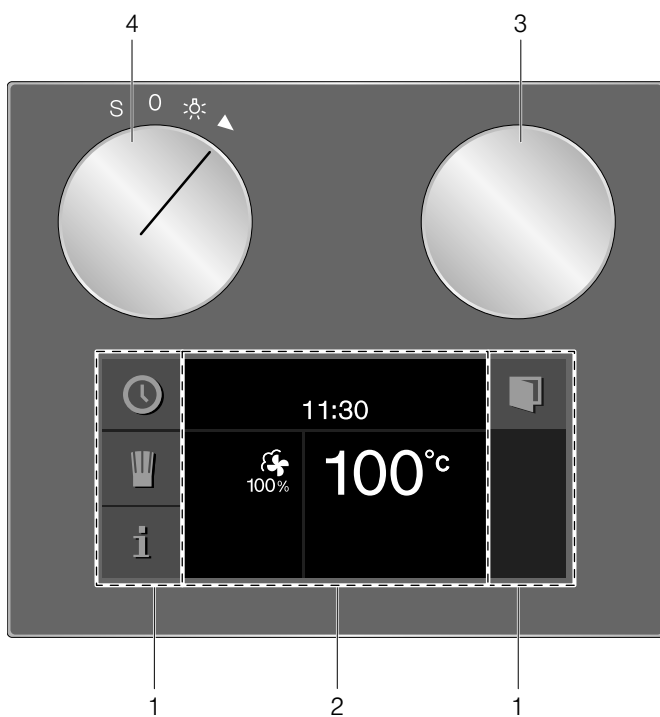

1	Control panel	These areas are touch sensitive. Touch a symbol to select the corresponding function.
2	Display	The display shows, for example, current settings and options.
3	Rotary selector	You can use the rotary selector to set the temperature and to make further settings.
4	Function selector	The function selector is used to select the type of heating, the cleaning programme or the basic settings.

Symbols

Symbol	Function
▶	Start
■	Stop
	Pause/End
X	Cancel
C	Delete
✓	Confirm/save settings
>	Selection arrow
🚪	Open appliance door
i	Call up additional information
⤴	Heating up with status indicator
🍷	Call up individual recipes
rec	Record menu
↶	Edit settings
>A [^]	Enter name
🔒	Child lock
🕒	Call up timer menu
🕒	Call up long-term timer
✂	Demo mode
🍴	Call up core temperature probe
🌫	Misting
👉	Steam removal start
👎	Steam removal stop

Colours and display

Colours

The different colours are used to guide the user in the relevant setting situations.

Orange	Initial settings Main functions
Blue	Basic settings Cleaning
White	Values which can be set

Display

The appearance of the symbols, values or the entire display changes depending on the situation.

Zoom	The setting which is currently being changed is displayed in an enlarged format. A cooking time that is coming to an end is shown in an enlarged format shortly before running out (e.g. the last 60 seconds of the timer).
Reduced display	After a short time, the display is reduced and only the most important information is displayed. This function is preset and can be changed in the basic settings.

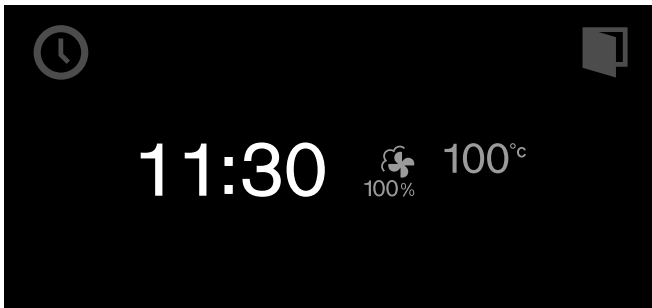

Automatic door opening

The appliance door springs open when you touch the  symbol and you can open it fully by using the recessed handle on the side.

Automatic door opening does not work if the child lock is activated or there is a power cut. You can open the recessed handle on the side by hand.

Additional information i and i[Ⓞ]

By touching the **i** symbol, you can call up additional information.

The **i[Ⓞ]** symbol appears for important information and indicates that an action is required. Important information on safety and operation mode are also intermittently shown automatically. These messages disappear automatically after several seconds or must be confirmed with .

Before starting, you are shown information, for example, on the type of heating which has been set. This allows you to check if the current setting is suitable for your meal.

During operation, you are shown information, for example, on the elapsed and remaining time and/or on the current cooking compartment temperature.

Note: Once the oven has heated up, slight deviations in temperature are normal during continuous operation.

Cooling fan

Your appliance has a cooling fan. The cooling fan switches on during operation. Depending on the appliance version, the hot air escapes above or under the door.



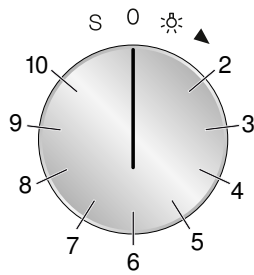

After removing cooked food, keep the door closed until the appliance cools down. The appliance door must not be left ajar, as adjoining kitchen furniture may be damaged. The cooling fan continues to run for a certain time after operation and then switches off automatically.

Caution! Do not cover the ventilation slots. Otherwise, the appliance will overheat.

Function selector positions



Position	Function/heating function	Temperature	Application
0	OFF position		
1	Light		
2	Hot air + 100% humidity	30 - 230 °C Default temperature 100 °C	Steaming at 70 °C - 100 °C: for vegetables, fish and side dishes. Meals are surrounded entirely by steam Combined operation at 120 °C - 230 °C: for puff pastry, bread and bread rolls. Hot air and steam are combined.
3	Hot air + 80% humidity	30 - 230 °C Default temperature 180 °C	Combined operation: for puff pastry, meat and poultry. Hot air and steam are combined.
4	Hot air + 60% humidity	30 - 230 °C Default temperature 170 °C	Combined operation: for yeast dough and bread. Hot air and steam are combined.
5	Hot air + 30% humidity	30 - 230 °C Default temperature 170 °C	Cooking in own moisture: for cakes and biscuits. When you select this mode, no steam is generated, but the ventilation flap is closed. Thus, the moisture escaping from the food stays in the oven interior and prevents drying out of prepared foods.
6	Hot air + 0% humidity	30 - 230 °C Default temperature 170 °C	Hot air: for cakes, biscuits and soufflés. The fan on the rear wall distributes the heat evenly in the cooking compartment.
7	Dough proofing	30 - 50 °C Default temperature 38 °C	Raising: for yeast and sour dough. The dough rises much faster than at room temperature. Hot air and steam are combined to ensure the dough surface does not dry out. The optimum temperature setting for yeast dough is 38 °C.
8	Defrosting	40 - 60 °C Default temperature 45 °C	For vegetables, meat, fish and fruit. Thanks to the moisture, heat is transferred to meals evenly. Meals do not dry out and do not lose their shape.
9	Regenerating	60 - 180 °C Default temperature 120 °C	For cooked and baked food. Pre-cooked food is gently heated up again. The moisture keeps the food from drying out. Regenerating pre-cooked meals on a plate at 120 °C and baked items at 180 °C.
10	Low-temperature cooking	70 - 90 °C Default temperature 70 °C	Low-temperature cooking for meat. Gentle, slow cooking for a particularly tender result.

Position	Function/heating function	Temperature	Application
S	 Basic settings		Your appliance can be individually adjusted in the basic settings.
	 Cleaning programme		The cleaning program removes soiling with steam.
	 Drying programme		The drying program dries the oven interior after steaming or cleaning.
	 Descaling programme		With the descaling programme you remove limescale from the oven interior.
	 Water filter change		Changing the water filter cartridge if the descaling filter has been installed.

Accessories

Use only the accessories supplied with the product or available from the after-sales service. They are specially designed for your appliance. Ensure that you always insert the accessories into the cooking compartment the right way round.

Your appliance is equipped with the following accessories:



Wire rack

for cookware, cake tins and casseroles and for roasts

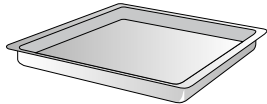

Stainless steel cooking container, unperforated, GN 2/3, 40 mm deep

for cooking rice, pulses and cereals, for baking cake baked on trays and for collecting dripping liquid during steaming

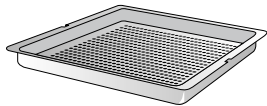

Stainless steel cooking container, perforated, GN 2/3, 40 mm deep

for steaming vegetables or fish, for extracting juice and for defrosting

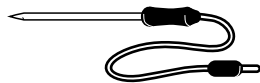

Core temperature probe

for precise preparation of meat, fish, poultry and bread

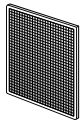

Grease filter

protects the fan of the side panel of the cooking compartment from becoming dirty (e.g. from spattering)

Inlet hose, 3 m

Outlet hose, 3 m

Special accessories

You can order the following special accessories from your specialist dealer:

- BA 476 310 Handle, stainless steel for BS 470/471/474/475
- BA 478 310 Handle, stainless steel for BS 484/485
- GF 111 100 Descaling and neutralising filter (filter head with filter for first installation)
- GF 121 110 Filter cartridge for descaling and neutralising filter
- GN 114 130 Stainless steel cooking container GN 1/3, perforated, 40 mm deep, 1.5 l
- GN 114 230 Stainless steel cooking container GN 2/3, unperforated, 40 mm deep, 3 l
- GN 124 130 Stainless steel cooking container GN 1/3, perforated, 40 mm deep, 1.5 l
- GN 124 230 Stainless steel cooking container GN 2/3, perforated, 40 mm deep, 3 l
- GN 340 230 Cast aluminium roaster GN 2/3, 165 mm high, non-stick coated
- GN 410 130 Stainless steel lid, GN 1/3
- GN 410 230 Stainless steel lid, GN 2/3
- GR 220 046 Wire rack, chrome-plated, with feet
- GZ 010 011 Inlet and outlet hose extension, 2 m

Only use the accessories as specified. The manufacturer accepts no liability if these accessories are used incorrectly.

Before using for the first time

Here you will find everything you need to do before using the appliance to prepare food for the first time. First read the section on *Important safety information*.

After connection to the mains, the "Initial settings" menu appears in the display. You can now make settings for your new appliance.

- Language
- Time format
- Time
- Date format
- Date
- Water hardness

The appliance must be fully installed and connected to the mains.

Notes

- The "Initial settings" menu appears only when the appliance is switched on for the first time after being connected to the mains or when the appliance has been without electricity for several days. After the appliance is connected to the mains, the GAGGENAU logo is displayed for approx. 30 seconds before the "Initial settings" menu is automatically displayed.
- You may change the settings at any time (refer to the *Basic settings* section).

Setting the language

The preset language appears in the display.

- 1 Turn the rotary selector to select the required display language.
- 2 Confirm with ✓.

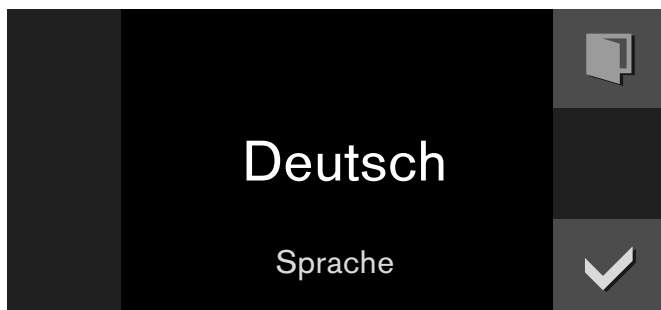

Setting the time format

The two possible formats 24h and AM/PM appear in the display. The default is the 24h format.

- 1 Use the rotary selector to select the desired format.
- 2 Confirm with ✓.

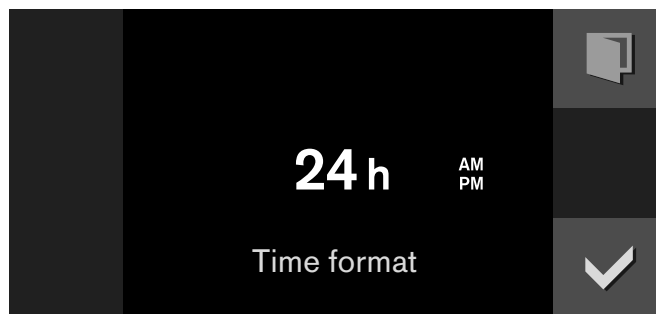

Setting the clock

The time is shown in the display.

- 1 Set the desired time using the rotary selector.
- 2 Confirm with ✓.

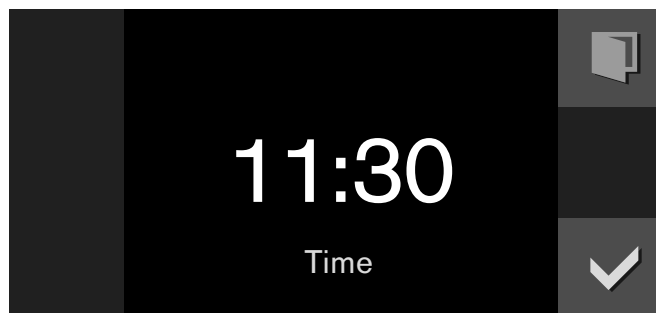

Setting the date format

The three possible formats D.M.Y, D/M/Y and Y/M/D appear in the display. The default is the D.M.Y format.

- 1 Use the rotary selector to select the desired format.
- 2 Confirm with ✓.

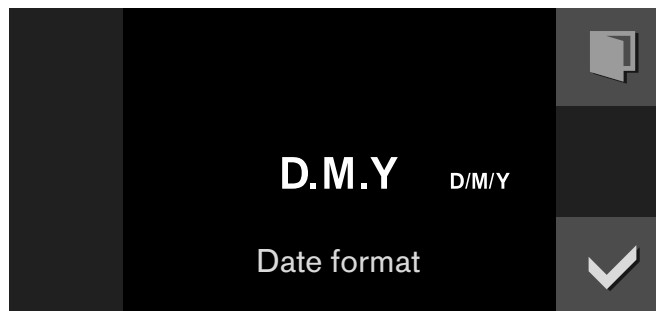

Setting the date

The preset date appears in the display. The day setting is already active.

- 1 Set the day using the rotary selector.
- 2 Touch the > symbol to switch to the month setting.
- 3 Set the month using the rotary selector.
- 4 Touch the > symbol to switch to the year setting.
- 5 Set the year using the rotary selector.
- 6 Confirm with ✓.

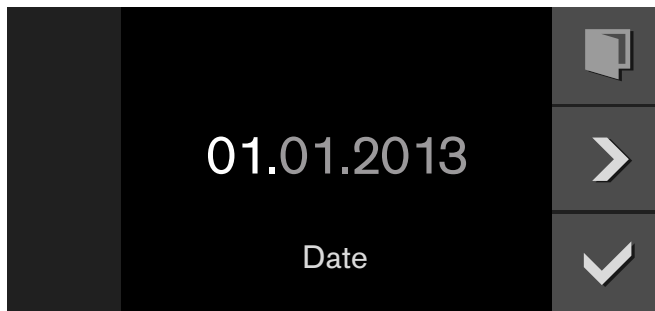

Setting the water filter

"Water filter" appears in the display. The default is "Available".

It is recommended to install the descaling system GF 111 100 if the water hardness exceeds 7° dH (carbonate hardness 5° dH).

- 1 Use the rotary selector to select "Available" (with water filter) or "Not available" (without water filter).
- 2 Confirm with ✓.
- 3 If water filter "Available" has been selected: "Water filter capacity" is shown in the display.
- 4 Turn the rotary selector to select the capacity of the filter cartridge (between 100 - 9000 litres). Refer to the instructions included with the filter cartridge.
- 5 Confirm with ✓.

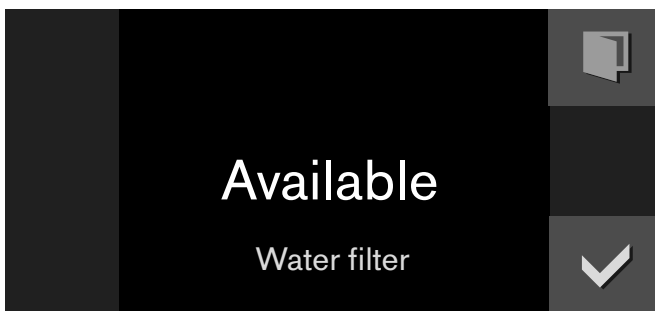

Setting the water hardness

"Water hardness" appears in the display.

- 1 Check the mains water with the included carbonate hardness test: fill the small measurement tube with mains water up to the 5 ml mark.
- 2 Add drops of indicator solution until the color changes from purple to yellow.
Important: count the drops and carefully swing the measurement tube after every drop until the liquids have mixed thoroughly. The number of drops corresponds to the water hardness.
- 3 Use the rotary selector to set the measured water hardness. The value 12 is set by default.
- 4 Confirm with ✓.

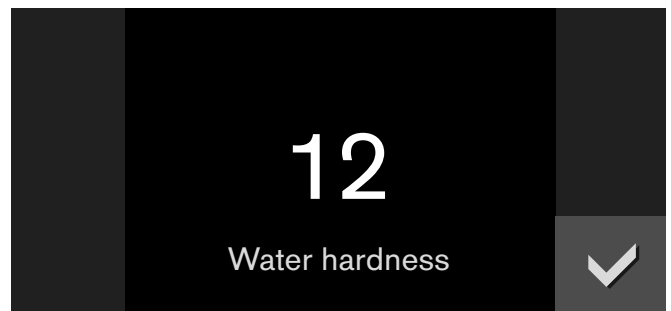

Ending initial set-up

"Initial set-up complete. Please calibrate the appliance before first cooking." appears in the display.

Confirm with ✓.

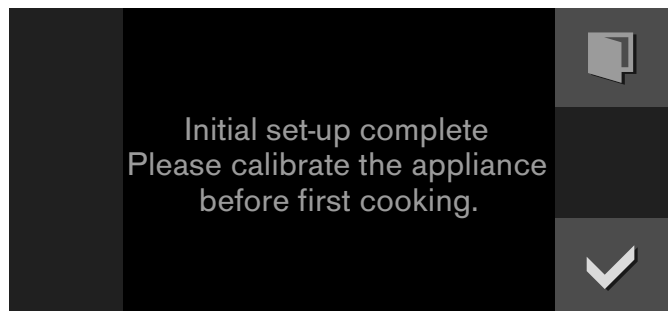

The appliance enters standby mode and the standby screen appears. The appliance is now ready for operation.

Calibrate the appliance before steaming for the first time. The appliance sets the boiling point.

Calibration

The boiling point of water depends on barometric pressure. As air pressure drops with increasing elevation, the boiling point drops as well. During calibration, the appliance sets the boiling point to the pressure conditions at the place where it is installed.

It is important that the appliance steams without interruption for 20 minutes at 100°C. Do not open the appliance door during this time.

Notes

- Calibrate the appliance only when it is cold.
 - During calibration, the appliance generates more steam than it normally would do.
- 1 Turn the function selector to **S**.
 - 2 Select "Basic settings" using the rotary selector.
 - 3 Touch the ✓ symbol.
 - 4 Select "Calibration" using the rotary selector.
 - 5 Touch the ↵ symbol.
 - 6 Remove all accessories from the oven interior and touch the ✓ symbol.
 - 7 The duration of 20:00 minutes appears. Touch ▶ to start calibration.

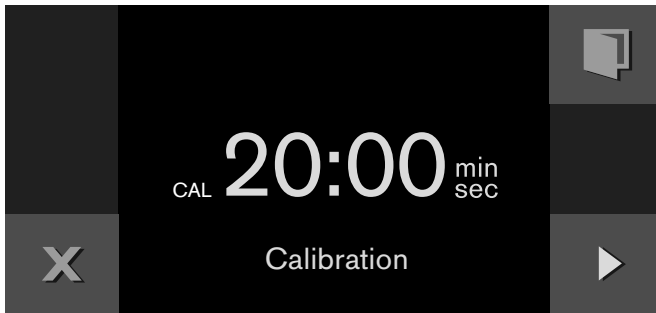

Calibration begins. The elapsing time is shown on the display.

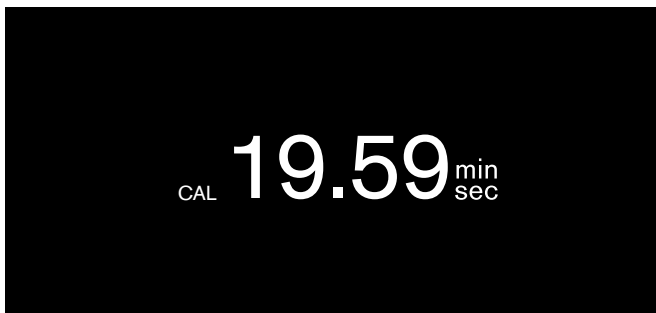

Note: Do not interrupt calibration. Do not turn the function selector. Do not open the appliance door.

A message appears in the display once calibration has ended. Touch ✓ to confirm and turn the function selector to **0**.

After moving house

Repeat calibration so that the appliance will automatically adjust itself to the new location.

After a power cut

The appliance saves the calibration settings even in the event of a power cut or disconnection from the mains. Recalibration is not necessary.

Grease filter

Hook the enclosed grease filter onto the hot air grille in the side wall of the cooking compartment.

Remove the left slide-in rail first (see section entitled *Removing slide-in rails*).

Leave the grease filter in the cooking compartment for all applications. Clean the grease filter with hot soapy water or in the dishwasher every time heavy dirt deposits have been left behind after cooking.

Cleaning accessories

Before using the accessories for the first time, clean them thoroughly using hot detergent solution and a soft cloth.

Water filter

Operation with or without a water filter

You can use the appliance with or without a water filter.

If the water hardness exceeds 7° dH or carbonate hardness 5° dH, we recommend the installation of the descaling system GF 111 100.

Changing the water filter

Filter cartridges should be replaced regularly. Replacement cartridges are available from after-sales service or in the online shop (order number GF 121 110).

The capacity of the filter cartridge depends on the frequency of use of the appliance and your regional water hardness. A message will appear in the display to remind you when the filter needs to be replaced. Regardless of the actual amount of water filtered the filter cartridge needs to be changed after 12 months at the latest.

- 1 Set the function selector to **S**. Select "Water filter change" using the rotary selector.
- 2 The ☰ symbol is displayed. Confirm with ✓.
- 3 Change the water filter cartridge. Refer to the instructions included with the filter cartridge. Confirm with ✓.
- 4 "Water filter capacity" is shown in the display. Confirm with ✓.
- 5 Turn the rotary selector to select the capacity of the filter cartridge (between 100 - 9000 litres). Confirm with ✓.

The water filter change is complete. Confirm with ✓. The appliance is now ready for operation.

Activating the appliance

Standby

The appliance goes into standby mode if no function has been set or the child lock is activated.

The brightness of the control panel is dimmed in standby mode.

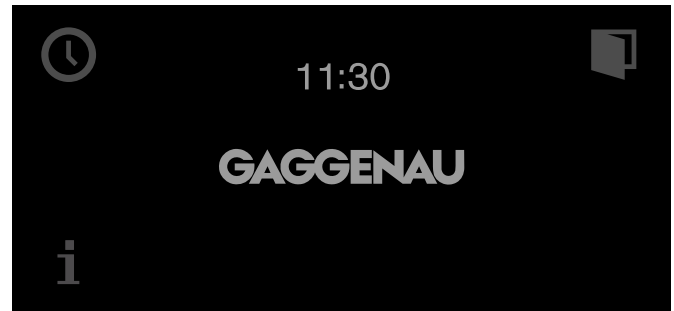

Notes

- Different displays are available for standby mode. The default setting is the GAGGENAU logo and the clock. To change the display, refer to the *Basic settings* section.
- The brightness of the display depends on the vertical viewing angle. You can adjust the display using the "Brightness" setting in the basic settings.

Activating the appliance

To exit standby mode, you can either:

- turn the function selector,
- touch a control panel,
- or open or close the door.

You can now set the required function. Please refer to the corresponding sections for information on how to set functions.

Notes

- If no settings are implemented for a long period of time after activation, the standby screen will reappear.
- When the door is open, the interior lighting goes out after a short time.

Operating the appliance

Cooking compartment

The cooking compartment has four shelf positions. The shelf positions are counted from the bottom up.

Note: When steaming, defrosting, dough proofing and regenerating, you can use up to three insertion levels at the same time (levels 2, 3 and 4). You can only bake on one level, use level 2 when baking (or level 1 for higher cake tins).

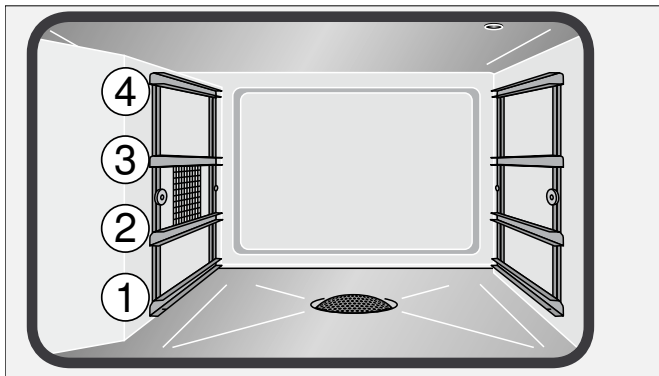

Caution!

- Do not place anything on the cooking compartment floor. Do not cover it with aluminium foil. A build-up of heat could damage the appliance. The cooking compartment floor must always be kept clear. Always place ovenware in a perforated cooking container or on a wire rack.
- Do not slide any accessories between the shelf positions, or they may tip.

Inserting accessories

The wire rack and the unperforated cooking container feature a locking function. The locking function prevents the accessories from tilting when they are pulled out. The accessories must be inserted into the cooking compartment correctly for the tilt protection to work properly. When removing accessories, you must raise them slightly.

When inserting the wire rack, check

- that the engaging lug (a) is pointing upward
- that the safety bar on the wire rack is at the back and facing upwards.

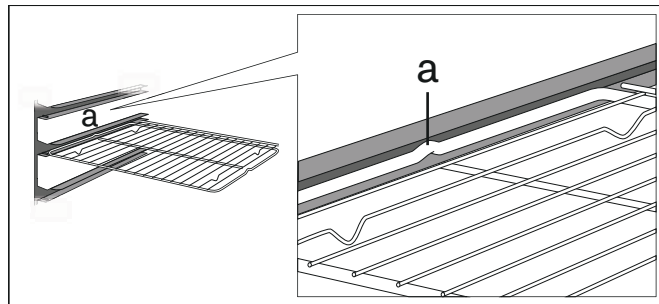

When pushing in the unperforated cooking container, make sure that the recess (a) is pointing to the side.

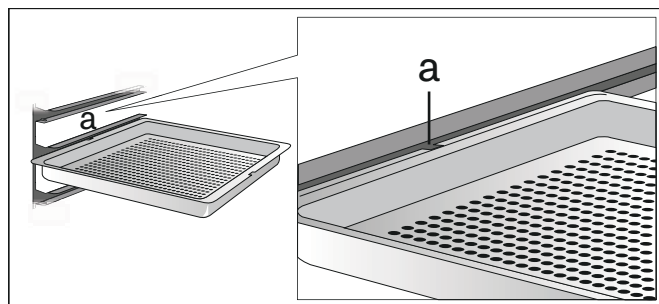

Switching on

- 1 Set the required heating mode using the function selector. The chosen heating mode and the default temperature are displayed.
- 2 If you want to change the default temperature: set the required temperature with the rotary selector.

The preheating symbol $\hat{=}$ appears on the display. The bar continuously shows the preheating status. When the set temperature is reached, a signal sounds and the preheating symbol $\hat{=}$ goes off.

Note: The oven interior lighting stays switched off at a temperature setting below 70°C

Switching off:



Turn the function selector to 0.

Misting

Misting brings additional steam to the oven interior. You can add moisture to food while cooking (e.g. bread, bread rolls).

Misting is only possible with these heating functions:

- Hot air + 30% humidity
- Hot air + 0% humidity

Touch the  symbol as long as you want to add steam, up to 8 seconds. After waiting at least one second, you can trigger misting again by touching the  symbol.

Steam removal

Steam removal brings cold water to the cooking compartment. This cools down the cooking compartment, the steam condenses. This reduces the steam escaping when opening the door.

Risk of scalding!

Hot water may drip from the door when opened.

You can use the steam removal function only up to a temperature of 130°C with the following heating functions:

- Hot air + 100% humidity
- Hot air + 80% humidity
- Hot air + 60% humidity

Starting steam removal:

Touch the  symbol. Steam removal lasts about 20 seconds. The heating remains switched off during steam removal.

Stopping steam removal:

Open the oven door or touch the  symbol.

Note: The steam removal function remains available for a short time after opening the oven door.

After every use

- 1 Remove soiling from the cooking compartment as soon as it has cooled down. Burnt-on remains will be much harder to remove later.
- 2 Once it has cooled down, wipe out the cooking compartment and dry well with a soft cloth.
- 3 Wipe kitchen units or handles if condensation has formed on them.
- 4 Dry the cooking compartment with the drying programme (see section entitled *Drying programme*) or leave the appliance door open until the interior has dried completely.

Safety shut-off

For your protection, the appliance is equipped with an automatic safety shut-off. Any heating process is switched off after 12 hours if the oven is not operated in this time. A message appears in the display.

Exception:

The long-term timer has been programmed.

Confirm the message with  and set the function selector to **0**, then the appliance can be operated again as usual.

Timer functions

You use the timer menu to make the following settings:

- ⌘ Short-term timer
- ⌚ Stopwatch
- 🕒 Cooking time (not in standby mode)
- 🕒 Cooking time end (not in standby mode)

Calling up the timer menu

You can call up the timer menu from any mode. Only from the basic settings, function selector is set to **S**, the timer menu is not available.

Touch the ⌚ symbol.

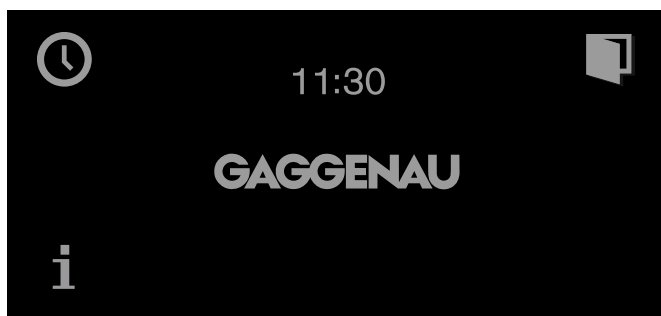

The timer menu is displayed.

Timer

The timer runs independently of the other appliance functions. You can enter a maximum of 90 minutes.

Setting the timer

- 1 Call up the "Timer" menu.
The ⌘ "Timer" function is displayed.
- 2 Turn the rotary selector to set the desired time.

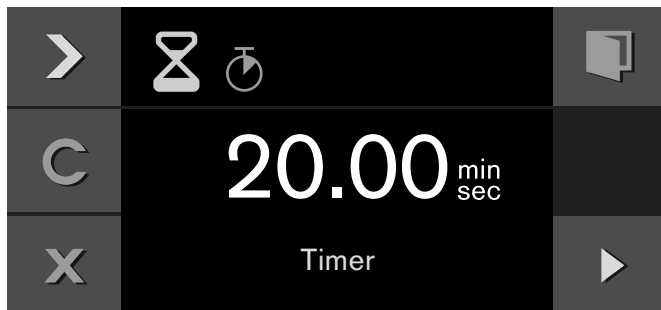

- 3 Press ▶ to start.

The "Timer" menu is closed and the time starts counting down. The ⌘ symbol and the elapsed time are shown in the display.

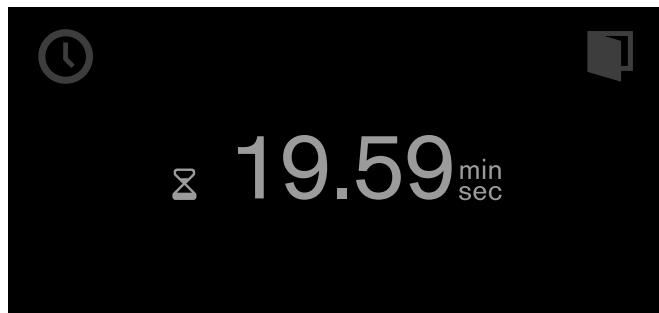

A signal sounds once the time has elapsed. The signal stops if you touch the ✓ symbol.

You can cancel all the settings at any time by touching the ✕ symbol. The settings are lost when you do this.

To stop the timer:

Call up the "Timer" menu. Touch ▶ to select the ⌘ "Timer" function and touch the || symbol. To allow the timer to continue counting down, touch the ▶ symbol.

To switch off the timer before it has finished:

Call up the "Timer" menu. Touch ▶ to select the ⌘ "Timer" function and touch the C symbol.

Stopwatch

The stopwatch runs independently of the other appliance functions.

The stopwatch counts from 0 seconds up to 90 minutes.

It also has a pause function, which enables you to temporarily stop the clock.

Starting the stopwatch

- 1 Call up the "Timer" menu.
- 2 Touch ▶ to select the ⌚ "Stopwatch" function.

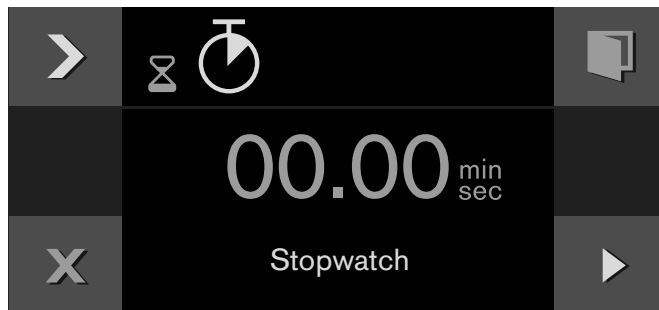

- 3 Press ▶ to start.

The "Timer" menu is closed and the time starts counting down. The ⌚ symbol and the elapsed time are shown in the display.

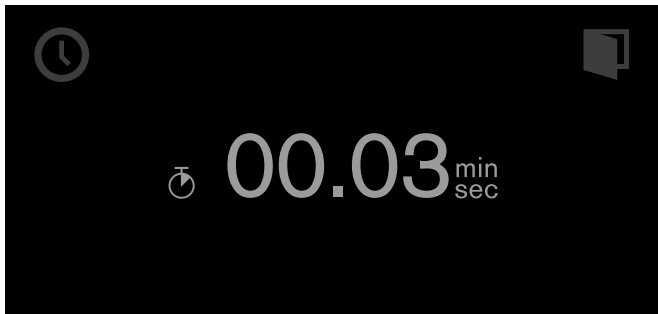

Pausing and restarting the stopwatch

- 1 Call up the "Timer" menu.
- 2 Touch > to select the ⌚ "Stopwatch" function.
- 3 Touch the || symbol.

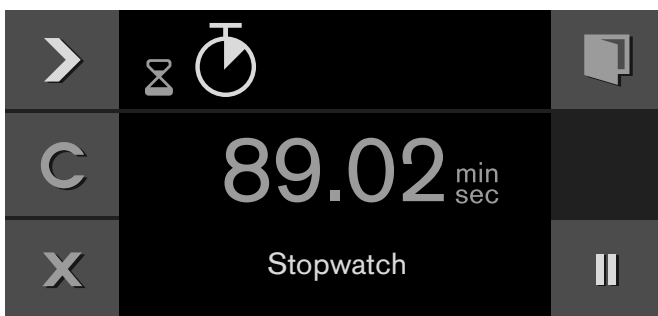

The time stops. The symbol changes to ▶ "Start".

- 4 Press ▶ to start.

The time continues to run. When 90 minutes is reached, the display pulsates and a signal sounds. The signal stops when you touch the ✓ symbol. The ⌚ symbol in the display goes out. The process has finished.

To switch off the stopwatch:

Call up the "Timer" menu. Touch > to select the ⌚ "Stopwatch" function and touch the C symbol.

Cooking time

If you set a cooking time for your meal, the appliance switches off heating automatically after the selected time.

You can set a cooking time from 1 minute to 23 hours 59 minutes.

Setting a cooking time

You have set the heating mode and temperature and you have placed your dish in the oven.

- 1 Touch the ⌚ symbol.
- 2 Use > to select the ⌚ "Cooking time" function.

- 3 Set the desired cooking time using the rotary selector.



- 4 Press ▶ to start.

The appliance starts. The timer menu is closed. The settings for temperature, heating mode, elapsing time and cooking time end are shown in the display.



During the last minute of the cooking time the remaining time is displayed in an enlarged format.

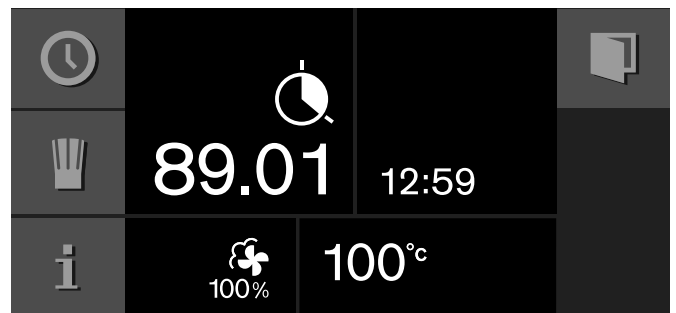

The appliance switches off after the cooking time has elapsed. The ⌚ symbol flashes and a signal sounds. The signal stops when you touch the ✓ symbol, open the appliance door, or switch the function selector to 0.

Changing the cooking time:

Call up the timer menu. Use > to select the ⌚ "Cooking time" function. Change the cooking time using the rotary selector. Press ▶ to start.

Clearing the cooking time:

Call up the timer menu. Use > to select the ⌚ "Cooking time" function. Clear the cooking time with C. Return to normal operation with X.

Cancelling the entire operation:

Set the function selector to 0.

Note: You can also change the heating mode and temperature during the cooking time.

End of cooking time

You can delay the cooking time end to a later time.

Example: it is 14:00. The dish requires a cooking time of 40 minutes. You want it to be ready at 15:30.

Enter the cooking time and delay the cooking time end until 15:30. The electronics system calculates the start time. The appliance starts automatically at 14:50 and switches off at 15:30.

Bear in mind that food which spoils easily should not be left in the cooking compartment for too long.

Delaying the cooking time end

You have set the heating mode, temperature and cooking time.

- 1 Touch the ⌚ symbol.
- 2 Use ➤ to select the ⌚ "Cooking time end" function.



- 3 Set the desired cooking time end using the rotary selector.
- 4 Press ➤ to start.

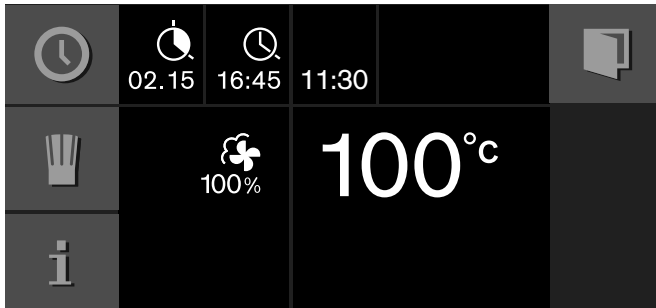

The appliance switches to standby. The heating mode, temperature, cooking time and cooking time end appear in the display. The appliance starts at the calculated time and switches off automatically when the cooking time has elapsed.

Note: If the ⌚ symbol flashes: You have not set the cooking time. Always set the cooking time first.

Once the cooking time has elapsed, the appliance switches off. The ⌚ symbol flashes and an audible signal sounds. The signal stops early if you touch the ✓ symbol, open the appliance door, or set the function selector to 0.

To change the cooking time end:

Call up the timer menu. Use ➤ to select the ⌚ "Cooking time end" function. Set the desired cooking time end using the rotary selector. Press ➤ to start.

To terminate the whole procedure:

Set the function selector to 0.

Long-term timer



With this function, the appliance maintains a temperature between 50 and 230 °C with the "Hot air" heating function.

You can keep food warm for up to 74 hours without having to switch the appliance on or off.







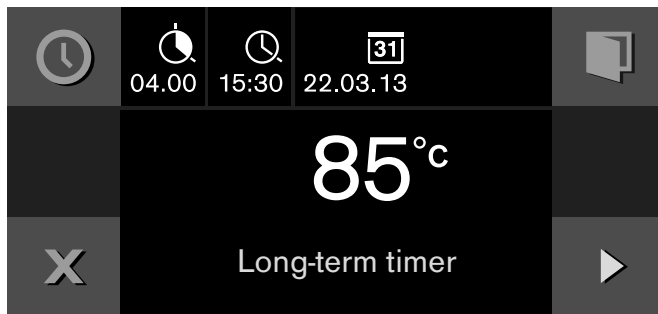

Bear in mind that food which spoils easily should not be left in the oven for too long.

Note: You must set the long-term timer to "available" in the basic settings (refer to the *Basic settings* section).

Setting the long-term timer

- 1 Set the function selector to .
- 2 Touch the  symbol.
The default value 24 hrs at 85 °C appears in the display. Press  to start
–or–
Change the cooking time, the cooking time end and the switch-off date.



- 3 Changing the cooking time :
Touch the  symbol. Set the required cooking time using the rotary selector.
- 4 Changing the cooking time end :
Touch the  symbol. Set the required cooking time end using the rotary selector.
- 5 Changing the switch-off date :
Touch the  symbol. Set the required switch-off date with the rotary selector. Confirm with .
- 6 Changing the temperature:
Set the required temperature with the rotary selector.
- 7 Press  to start.

The appliance starts.  and the temperature appear in the display.

The oven and display lighting are switched off. The control panel is locked; no key tone sounds when you touch the touch keys.

Once the set time has elapsed, the appliance stops heating. Turn the function selector to 0.

Switching off:



To end the process, turn the function selector to 0.

Individual recipes

It is possible to save up to 50 individual recipes. You can record a recipe. These recipes can be given a name so that they can be called up quickly and conveniently when required.

Recording a recipe

It is possible to consecutively set up to 5 phases and to record at the same time.

- 1 Select the required heating mode using the function selector.
The  symbol is displayed.
- 2 Touch the  symbol.
- 3 Select a free memory location by turning the rotary selector.
- 4 Touch the  symbol.

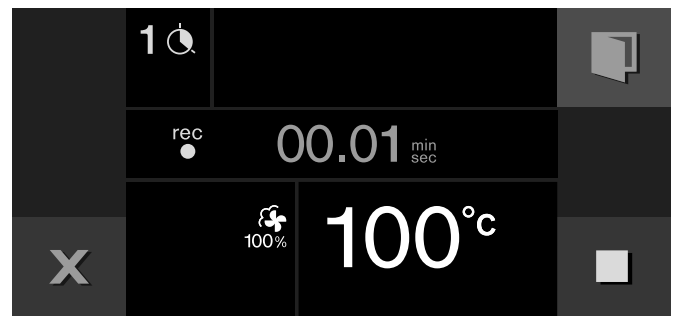

- 5 Select the required temperature using the rotary selector.
- 6 The cooking time is recorded.
- 7 To record another phase:
Select the required heating mode using the function selector. Set the temperature using the rotary selector. This begins a new phase.
- 8 If the dish has achieved the desired cooking result, touch the  symbol to finish the recipe.
- 9 Enter the name in "ABC" (refer to the *Entering names* section).

Notes

- Recording of a phase starts only once the selected temperature has been reached.
- The minimum duration of each phase is 1 minute.
- During the first minute of a new phase it is possible to change the heating mode or the temperature.

Entering names

- 1 Enter the name of the recipe in "ABC".



Rotary selector	Select letters A new word always begins with a capital letter.
>A ^ä	Press briefly: moves the cursor right Press and hold: shifts to umlauts and special characters Press twice: adds a line break
>Ä	Press briefly: moves the cursor right Press and hold: shifts to normal characters Press twice: adds a line break
C	Deletes letters

- 2 Save with ✓.
- or -
Cancel with X and exit the menu .

Note: For entering a name, Latin characters, certain special characters and numbers are available.

Starting recipes

- 1 Set the function selector to any heating mode. The 🍲 symbol is displayed.
- 2 Touch the 🍲 symbol. Use the rotary selector to select the required recipe.
- 3 Press ▶ to start.
Operation starts. The cooking time starts counting down in the display.
The settings for each phase are shown in the display.

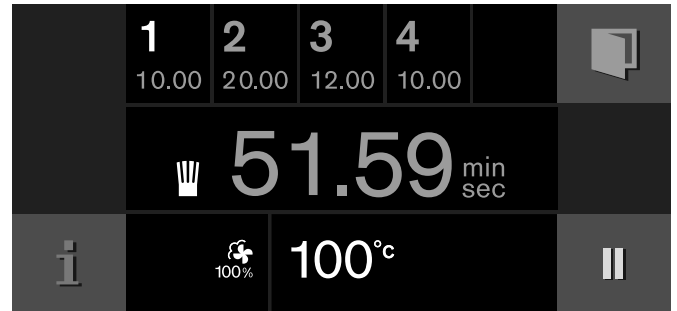

Note: You can change the temperature with the rotary selector while the recipe is running. This does not change the stored recipe.

Deleting recipes

- 1 Set the function selector to any type of heating. The 🍲 symbol is displayed.
- 2 Touch the 🍲 symbol.
- 3 Use the rotary selector to select the desired recipe.
- 4 Delete the recipe with C.
- 5 Confirm with ✓.

Core temperature probe

The core temperature probe enables exact cooking to the spot. It measures the temperature inside the food being cooked. Automatic switching off when the desired core temperature is reached ensures that each food is cooked precisely.

Use the included core temperature probe only. You can purchase one as a spare part from after-sales service or in the online shop.

The core temperature probe can be damaged at temperatures above 250°C. Therefore, only ever use it in your oven up to a temperature of 230°C.

Always remove the core temperature probe from the oven after use. Never store it in the oven.

After every use, clean the core temperature probe with a moist cloth. Do not wash it in a dishwasher!

⚠ Risk of electric shock!

The insulation of an incompatible meat probe may be damaged. Only use the meat probe which is recommended for this appliance.

⚠ Risk of burns!

The cooking interior and the core temperature probe become very hot. Use oven mitts to plug and unplug the core temperature probe.

Inserting the core temperature probe in the food to be cooked

Insert the core temperature probe in the food to be cooked before you place it in the cooking interior.

Insert the metal tip at the thickest point in the food to be cooked. Make sure that the end of the tip is approximately in the centre. It must not be placed in the fat and must not touch any cookware or bones.



If there are several pieces, insert the core temperature probe in the middle of the thickest piece.

Insert the core temperature probe completely, if possible.

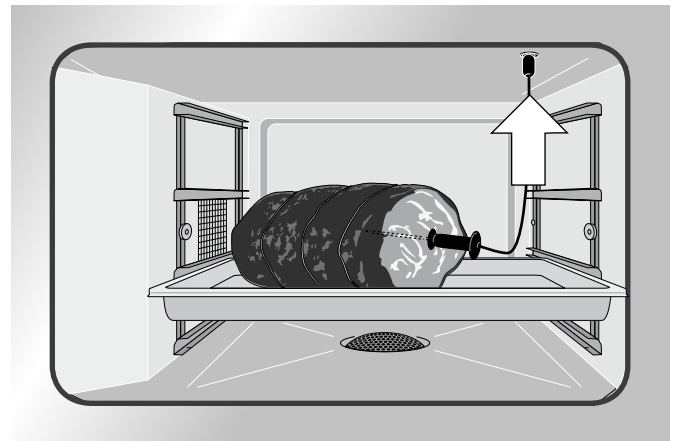
In the case of poultry, make sure that the tip of the core temperature probe is not in the cavity in the centre, but in the meat between the belly and upper leg.



Setting the core temperature

- 1 Insert food into the oven interior with the core temperature probe inserted. Insert the core temperature probe in the socket in the oven interior and close the appliance door.
Do not jam the core temperature probe's cable!
- 2 Set the function selector to the required heating mode.
- 3 Set the oven interior temperature with the rotary selector.
- 4 Touch the  symbol. With the rotary selector, set the required core temperature and confirm it with .
The set core temperature must be higher than the current core temperature.

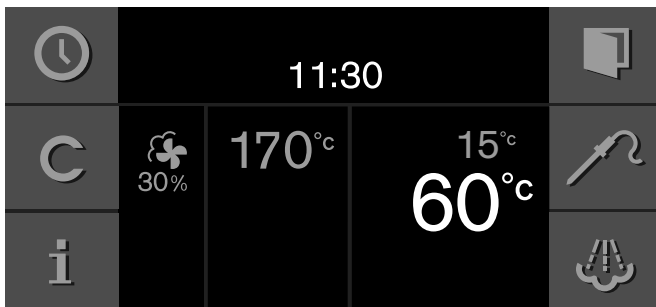



- 5 The appliance heats with the set heating mode. The current core temperature is displayed and, under it, the set core temperature. You can change the set core temperature at any time.

A signal sounds when the set core temperature in the food has been reached. The cooking mode is ended automatically. Confirm with  and turn the function selector to 0.

Notes

- The measurable range is 15 °C to 99 °C. Outside the measurable area, "--°C" is displayed for the current core temperature.
- If you leave food in the cooking compartment for some time after cooking, the core temperature continues to rise somewhat due to the residual heat in the cooking compartment.
- If you set the core temperature probe and the cooking timer at the same time, the appliance switches off whichever programme reaches the entered value first.

Changing the set core temperature:

Touch the  symbol. Use the rotary selector to change the set core temperature for the food and confirm with .

Deleting the set core temperature:

Touch the  symbol. Delete the set core temperature with **C**. The appliance continues heating in normal cooking operation.

Recommended core temperature values

Use fresh foodstuffs only. Do not use deep-frozen foods. The details in the table are recommended values. They depend on the quality and condition of foods.

For reasons of hygiene, fish and other critical foodstuffs should have a core temperature of at least 62 - 65 °C after cooking.

Cooked food	Recommended core temperature
Rind	
Roast beef, fillet of beef, entrecote	
very rare	45 - 47 °C
rare	50 - 52 °C
medium-rare	58 - 60 °C
well-done	70 - 75 °C
Roast beef	80 - 85 °C
Pork	
Roast pork	
	72 - 80 °C
Back of pork	
medium-rare	65 - 70 °C
well-done	75 °C
Meat loaf	85 °C
Fillet of pork	65 - 70 °C
Veal	
Roast veal, well-done	
	75 - 80 °C
Breast of veal, stuffed	
	75 - 80 °C
Back of veal	
medium-rare	58 - 60 °C
well-done	65 - 70 °C
Fillet of veal	
rare	50 - 52 °C
medium-rare	58 - 60 °C
well-done	70 - 75 °C
Venison	
Saddle of venison	
	60 - 70 °C
Leg of venison	
	70 - 75 °C
Venison steak	
	65 - 70 °C
Rack of hare, rack of rabbit	
	65 - 70 °C
Poultry	
Chicken	
	85 °C
Guinea fowl	
	75 - 80 °C
Goose, turkey, duck	
	80 - 85 °C

Cooked food	Recommended core temperature
Duck breast	
medium-rare	55 - 60 °C
well-done	70 - 80 °C
Ostrich steak	60 - 65 °C
Lamb	
Leg of lamb	
medium-rare	60 - 65 °C
well-done	70 - 80 °C
Saddle of lamb	
medium-rare	55 - 60 °C
well-done	65 - 75 °C
Mutton	
Leg of lamb	
medium-rare	60 - 65 °C
well-done	70 - 80 °C
Saddle of lamb	
medium-rare	70 - 75 °C
well-done	65 - 75 °C
Mutton	
Fillet steak	
	62 - 65 °C
Whole	
	65 °C
Terrine	
	62 - 65 °C
Miscellaneous	
Bread	
	90 °C
Vol-au-vent	
	72 - 75 °C
Terrine	
	60 - 70 °C
Foie gras	
	45 °C

Child lock

The appliance has a child lock to prevent children operating it accidentally.

Notes

- You must set the child lock to "Available" in the basic settings (refer to the *Basic settings* section).
- If there is a power cut when the child lock is active, the child lock may be deactivated when the power supply returns.

Activate the child lock

Prerequisite:

The function selector is set to **0**.

Touch and hold the  symbol for at least 6 seconds.

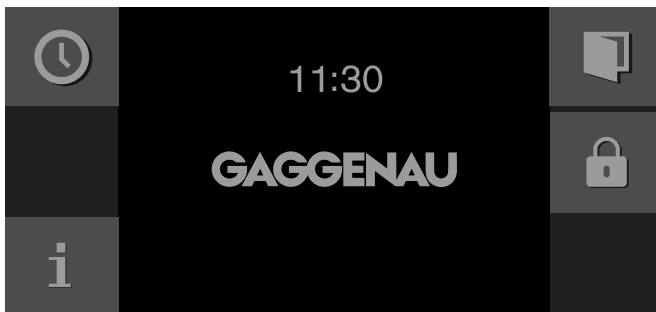

The child lock is activated. The standby screen appears. The  symbol is shown at the top of the display.

Deactivating the child lock

Touch and hold the  symbol for at least 6 seconds.

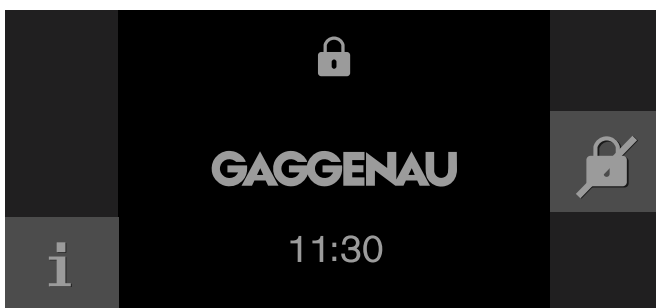

The child lock is deactivated. You can set the appliance as usual.

Basic settings

Your appliance can be individually adjusted in the basic settings.

- 1 Turn the function selector to **S**.
- 2 Select "Basic settings" using the rotary selector.
- 3 Touch the ✓ symbol.
- 4 Turn the rotary selector to select the required basic setting.













5 Touch the ↘ symbol.











6 Set the basic setting using the rotary selector.

7 Save with ✓ or cancel with ✕ and exit the current basic setting.

8 Turn the function selector to **0** to exit the basic settings menu.

The changes are saved.

	Basic setting	Permitted settings	Explanation
	Brightness	Level 1, 2, 3, 4, 5*, 6, 7, 8	Sets the display brightness
	Standby screen	On*/Off - Clock - Clock + GAGGENAU logo* - Date - Date + GAGGENAU logo - Clock + date - Clock + date + GAGGENAU logo	Appearance of the standby screen. Off: No display. Use this setting to reduce the standby consumption of your appliance. On: Several displays can be set, confirm "On" with ✓ and use the rotary selector to select the desired display. The selection is displayed.
	Display screen	Reduced* / Standard	If set to <i>Reduced</i> , after a brief period only the most important information is shown.
	Touch field colour	Grey* / White	Selects the colour of the symbols on the touch fields
	Touch field tone	Tone 1* / Tone 2 / Off	Selects an audible signal for when a touch field is touched
	Touch field tone volume	Level 1, 2, 3, 4, 5*, 6, 7, 8	Sets the volume of the touch field tone
	Preheating signal	On* / Off	The signal tone sounds when the cooking compartment has heated up to the required temperature.
	Signal volume	Level 1, 2, 3, 4, 5*, 6, 7, 8	Sets the volume of the audible signal
	Water filter	Available*/not available	Available: Operating the appliance with a water filter. Not available: Operating the appliance without a water filter.
	Water filter capacity	100 - 9000 litres	Sets the water filter capacity
	Water hardness	1-18	Use the test kit included to test the water hardness of your mains water. Set the measured water hardness.
	Calibration	Calibrate the appliance	Adjusts the boiling point
	Time format	24 h* / AM/PM	Display the clock in 24 or 12-hour format

	Time	Current time	Setting the clock
	Clock change	Manual* / Automatic	Automatically changes the clock to daylight-savings time. If automatic: Setting the month, day and week for when the time should be changed over. To be set for both summer and winter time.
	Date format	D.M.Y* D/M/Y Y/M/D	Sets the date format
	Date	Current date	Sets the date. You can switch between year/month/day using the symbol ➤.
	Language	German* / French / Italian / Spanish / Portuguese / Dutch / Danish / Swedish / Norwegian / Finnish / Greek / Turkish / Russian / Polish / Czech / Slovenian / Slovakian / Arabic / Hebrew / Japanese / Korean / Thai / Chinese / English US / English	Selects the language for the text display
	Factory settings	Reset the appliance to the factory settings	Confirm the question "Delete all individual settings made and reset to factory settings" by pressing ✓ or cancel by pressing ✕.
	Demo mode	On / Off*	Only for presentation purposes. The appliance does not heat up in demo mode, all other functions are available. The "Off" setting must be activated for normal operation. The setting is only possible in the first 3 minutes after connecting the appliance to the mains.
	Long-term timer	Available / Not available*	Available: Long-term timer can be set; refer to the <i>Long-term timer</i> section.
	Door lock	Off* / On	The door lock prevents unintentional opening of the appliance door. When "On" is set, you must touch the  symbol for several seconds before the door opens.
	Child lock	Available / Not available*	Available: The child lock can be activated (refer to the <i>Child lock</i> section).

* Factory setting

Cleaning and maintenance

With thorough care and cleaning your appliance will retain its looks and remain in good order. We will explain here how you should care for and clean your appliance correctly.

Risk of burns!

The appliance becomes very hot. Never touch the interior surfaces of the cooking compartment or the heating elements. Always allow the appliance to cool down. Keep children at a safe distance.

Risk of electric shock!

Penetrating moisture may cause an electric shock. Do not use any high-pressure cleaners or steam cleaners.

Risk of injury!

Scratched glass in the appliance door may develop into a crack. Do not use a glass scraper, sharp or abrasive cleaning aids or detergents.

Cleaning agents

Pay attention to the information in the table to avoid damaging the various surfaces by incorrect cleaning agents.

Do not use

- harsh or abrasive cleaning agents
- metal or glass scrapers to clean the glass on the appliance door
- metal or glass scrapers to clean the door seal
- hard abrasive pads or cleaning sponges

Thoroughly rinse out new sponge cloths before use.

Area	Cleaning agent
Door panels	Glass cleaner: clean with a dish cloth. Do not use any glass scrapers.
Display	Wipe off with a microfiber cloth or a slightly moistened cloth. Do not wipe it off wet.
Stainless steel	Hot soapy water: clean with a dish cloth and dry with a soft cloth. Always remove flecks of limescale, grease, starch and albumin (e.g. egg white) immediately. Corrosion can form under such stains. Special stainless steel cleaning agents can be obtained from the after-sales service or from specialist retailers.
Aluminium	Clean with a mild window cleaning agent. Using a window cleaning cloth or a lint-free microfiber cloth, wipe horizontally over surfaces without applying pressure.

Area	Cleaning agent
Stainless steel or enamel oven interior	Hot soapy water: clean with a dish cloth and dry with a soft cloth. Do not use oven spray or other aggressive oven cleaners or abrasive agents. Scourers, rough sponges and pot cleaners are also unsuitable. They scratch the surface. For regular care, use oven interior care agents in compliance with the manufacturer's specifications (order number 667027 from after-sales service or in the online shop). Caution! – Do not spray cleaner into the ventilation flap on the top of the oven interior! – Cleaner residues will create stains when heated up. Before drying the oven interior, thoroughly remove cleaner or care agent residues with clear water. Always dry the oven interior after cleaning (see Section entitled <i>Drying program</i>).
Extremely soiled stainless steel or enamel oven interior	Oven cleaner gel (order number 463582 from after-sales service or in the online shop). Please note: ● Must not penetrate into seals on the door, the lamp or the evaporator tray ● Allow it to act for no more than 12 hours. ● Do not use on hot surfaces. ● Rinse thoroughly with water. ● Pay attention to manufacturers' specifications.
Glass ceramic grill (only for oven with stainless steel interior)	Clean the glass ceramic grill in the cooking compartment regularly with glass ceramic cleaner (order number 311298 from after-sales service or in the online shop). Remove burnt in residues with a glass scraper. Be careful not to scratch the cooking compartment.
Glass cover of oven interior lamp	Hot soapy water: Clean with a dish cloth.
Grease filter	Dishwasher
Door seal Do not remove!	Hot soapy water: clean with a dish cloth. Do not scrape. Do not use any metal or glass scrapers for cleaning.
Core temperature sensor	Wipe off with a moist cloth. Do not clean in a dishwasher.
Cooking receptacle, rack	Dishwasher or hot soapy solution. Soak baked-in grime and clean with a brush.
Slide-in racks	Dishwasher or hot soapy solution. See Section entitled <i>Removing slide-in racks</i>

Microfibre cloth





The honeycomb microfibre cloth is particularly suitable for cleaning sensitive surfaces such as glass, glass ceramic, stainless steel or aluminium (product no. 460770, also available from our online eShop). It removes liquid and greasy deposits in one go.

Cleaning programme



The cleaning programme loosens dirt in the cooking compartment and makes cleaning easy.

The cleaning programme consists of the steps of once cleaning and twice rinsing.

Starting the cleaning program

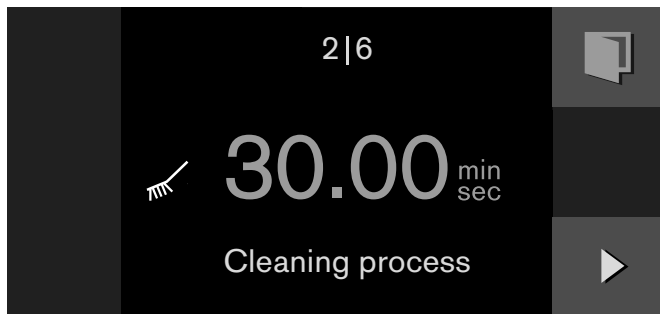
- 1 Set the function selector to **S**.
- 2 The  symbol is displayed. Touch  to confirm.
- 3 Remove accessories and grease filter from the oven interior. Remove slide-in racks from the oven interior (see section entitled *Removing slide-in racks*). Wipe out the cooking compartment with cleaner.
- 4 Close the appliance door. Touch  to confirm.
- 5 The cleaning time of 30 minutes appears. Touch  to start. The cleaning time elapses on the display. The light in the cooking compartment stays off.



- 6 A signal sounds after 30 minutes. A message appears on the display.
- 7 Wipe out the cooking compartment. Remove cleaner residues. Touch  to confirm.
- 8 The rinsing process appears. Touch  to start. The appliance rinses. The rinsing time elapses on the display.

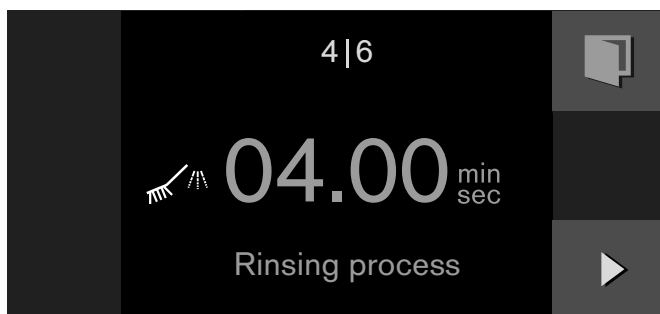

A signal sounds after 4 minutes. Touch  to confirm. Wipe the cooking compartment dry with a soft cloth and dry it completely with the drying program.



Note: Always allow the cleaning program to run fully. If the cleaning program has been cancelled prematurely, you must restart the rinsing operation before the next use.

Drying programme

With the drying program, you can dry the cooking compartment after cleaning or after steaming.

The drying program takes 20 minutes.

Starting the drying program

- 1 Remove accessories from the cooking compartment. Wipe out the cooking compartment. Thoroughly remove residues of cleaner. Close the appliance door.
- 2 Set the function selector to **S**. Select the drying program with the rotary selector.
- 3 The  symbol is displayed. Touch  to confirm.
- 4 The drying time of 20 minutes appears. Touch  to start. The drying time elapses on the display. The lamp in the cooking compartment stays off.

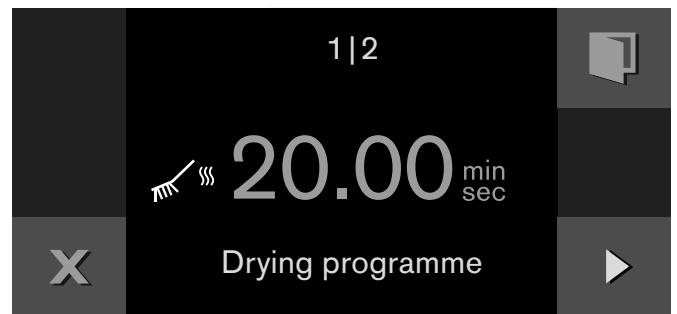

- 5 A signal sounds after 20 minutes. A message appears in the display. Touch  to confirm. The drying programme has ended. Allow the appliance to cool down. Then polish the cooking compartment and the panel with a soft cloth.

Descaling aid

To keep your appliance in good working order, you have to descale the cooking compartment regularly, especially the area behind the side plate. Depending on water hardness and frequency of use you will need to descale your appliance more often, especially for appliance versions with enamelled cooking compartment.

Be careful not to scratch the oven interior when removing the side plate. Small parts might fall into the base strainer. Tip: put a kitchen cloth over the oven base.

Descaler

For descaling, use only the descaler recommended by after-sales service (order No. 667025 from after-sales service or in the online shop). Other descaling agents can cause damage to the appliance.





Caution!

- Surface damage: Wipe off descaler immediately with water if it reaches the door seal, the front or other sensitive surfaces.
- Surface damage: Do not use harsh or abrasive cleaning agents or objects for descaling.

Notes

- **If using the descaling and neutralising filter (special accessory GF 111 100):** clean and descale the cooking compartment each time you change the filter cartridge. If it is not necessary to descale the cooking compartment, clean it with the oven interior care agent.
- We recommend, in combination with the descaler, our oven interior care agent for stainless-steel care and to neutralise descaler residues (order No 667027 from after-sales service or in the online shop). It contains a care agent, a soft non-scratch sponge and a lint-free cloth.

Starting the descaling programme

- 1 Set the function selector to **S**. Select the descaling programme with the rotary selector.
- 2 The  symbol is displayed. Touch  to confirm. Follow the instructions that are shown in the display.
- 3 Removing the side plate: detach the left slide-in rails first (see section entitled *Removing slide-in rails*). Detach the grease filter in the upward direction. Undo the forward bolt with a socket spanner (13 mm). Remove the side plate. Touch  to confirm.
- 4 Place the side plate separately in the sink and spray on descaler. Leave to act for a few minutes. Rinse thoroughly with plenty of water.
Caution! Do not let the descaling solution come into contact with surfaces that are sensitive to acid (e.g. marble worktops)!
- 5 Spray descaler onto the areas in the cooking compartment where limescale has developed. Leave to act for 1 - 3 minutes. Touch  to confirm.
- 6 Repeat the descaling process if necessary.
- 7 Thoroughly rinse off the descaler. Thoroughly clean the door seal with a clean, damp cloth. Use a spray bottle filled with water and a soft, clean sponge or cloth for rinsing.
Caution! Do not heat up the steam oven with descaler or descaling residues in the cooking compartment! This will lead to stains!
- 8 Re-insert the side plate. Re-attach the grease filter and the slide-in rail.
- 9 The rinsing process appears. Touch  to start. The appliance rinses. The rinsing time elapses on the display.

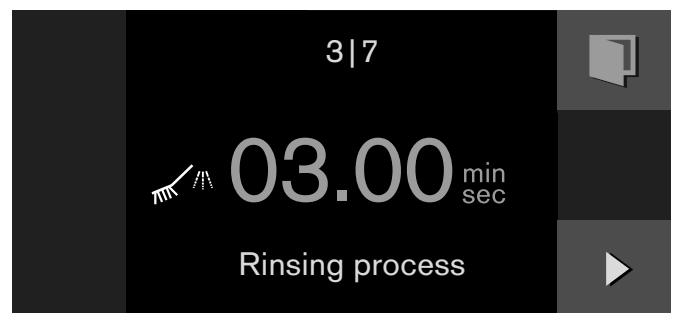

- 10 A signal sounds after 3 minutes. Touch  to confirm.

The descaling aid has ended. Delete the descaling hint in the display. Touch  to confirm.

Wipe the door seal with a clean, damp cloth. Wipe the cooking compartment dry with a soft cloth and dry it completely with the drying program.

Removing slide-in rails

You can remove the slide-in rails for cleaning.

Detaching the rails

- 1 Place a dish cloth in the cooking compartment to protect the stainless steel against scratches.
- 2 Undo the knurled nuts (Figure A).
- 3 Pull away the slide-in rails slightly sideward from the screw and pull it out toward you (Figure B).

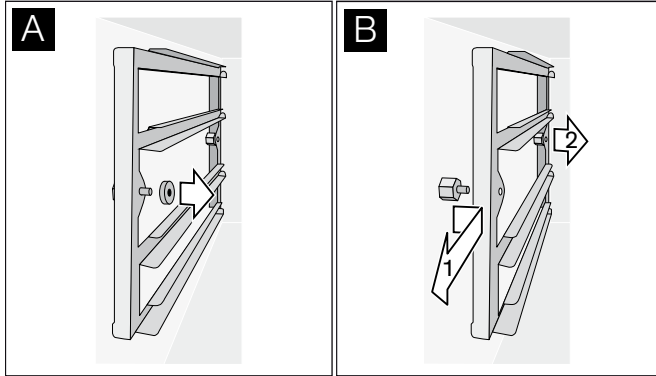

Clean the rails in the dishwasher.

Attaching the rails

- 1 Position the slide-in rails correctly with the stopper at the back.
- 2 Push the slide-in rails onto the bolt at the rear and then hook them in at the front.
- 3 Tighten the knurled nuts.





Note: If you should lose a knurled nut, you can order it as a spare part from our after-sales service. Using knurled nuts other than the original ones will cause corrosion in the oven interior.

Trouble shooting

Malfunctions often have simple explanations. Please read the following notes before calling the after-sales service.

Risk of electric shock!

Incorrect repairs are dangerous. Repairs may only be carried out by one of our trained after-sales engineers. If the appliance is faulty, unplug the mains plug or switch off the fuse in the fuse box. Contact the after-sales service.

Disruption	Possible cause	Solution
Appliance not working, no display	Plug not inserted	Connect the appliance to the electricity mains
	Power failure	Check whether other kitchen appliances are working
	Fuse defective	Check in the fuse box whether the fuse for the appliance is in working order
	Operating error	Switch off the fuse for the appliance in the fuse box and switch it on again after about 60 seconds
Appliance cannot be started	Appliance door is not quite closed	Close appliance door
Appliance does not work, display does not respond.  appears in the display	Child lock activated	Deactivate the child lock (refer to <i>Child lock</i> section)
Appliance switches off on its own	Safety shut-off: the appliance has not been operated for longer than 12 hours	Confirm the message with  , switch off the appliance and set it again.
Appliance does not heat up,  appears in the display	Appliance is in demo mode	Deactivate the demo mode in the basic settings
The appliance cannot be started, a message is shown on the display	No water available in the appliance	Check the water connection
No steam visible in the oven	Steam above 100°C is invisible	This is normal
The "steam removal"  symbol does not appear on the display	The steam removal function is only available if the oven temperature is below 130°C	This is normal
A lot of steam escapes at the top of the door	Appliance is calibrating the boiling point or is preheating or the heating mode has been changed	This is normal
	The appliance has not yet been calibrated	Calibrate the appliance
A lot of steam escapes at the side of the door	Door seal soiled or loose	Clean the door seal and insert it in the groove
Humming noise when switching on	The drain pump starts to operate	This is normal
	Appliance has been switched off for several days	This is normal: automatic rinsing when being switched on again
There is a "pop" noise during cooking	Cold/warm effect with frozen food, caused by the steam	This is normal
The appliance is not producing steam properly	Limescale has formed in the appliance	Start the descaling programme
Error message "Exxx"		If an error message is displayed, turn the function selector to 0 ; if the display goes out, there was a non-recurring problem. If the error occurs repeatedly or the display remains on, please contact the after-sales service and inform them of the error code.

Power cut

Your appliance can bridge a power cut of a few seconds. Operation continues.

If the power cut was for a longer period and the appliance was in operation, a message appears in the display. Operation is interrupted.

Set the function selector to **0**, then the appliance can be operated again as usual.

Demo mode

If the ✂ symbol appears in the display, the demo mode is activated. The appliance does not heat up.

Briefly disconnect the appliance from the mains (switch off the household fuse or the circuit breaker in the fuse box). Following this, deactivate the demo mode in the Basic settings within 3 minutes (refer to the *Basic settings* section).

Replacing the oven light

For technical reasons the lamp cover cannot be removed. Lamp must only be replaced by Gaggenau after-sales service.

Caution! Do not remove the lamp cover. This will damage the sealing.

If the lamp cover in the oven is damaged, it must be replaced. You can obtain covers from the after-sales service. Please supply your appliance's E number and FD number.

After-sales service

In the event of repairs please contact our after-sales service. We are committed to find the best solution also in order to avoid an unnecessary call-out.

Please quote the E number (product number) and the FD number (production number) of your appliance when contacting the after-sales service. The rating plate bearing these numbers can be found on the front side when you open the appliance door.

For future reference you can note the data of your appliance and the telephone number of our after-sales service below.

E-Nr.	FD-Nr.
-------	--------

After-sales service ☎

Please note that calling out an after-sales service technician is not free of charge, even within the warranty period, should the problem result from an operating error.

Please find the contact data of all countries in the enclosed customer service list.

To book an engineer visit and product advice

GB 0844 89289988

Calls from a BT landline will be charged at up to 3 pence per minute. A call set-up fee of up to 6 pence may apply.

IE 01450 2655

AU 1300 727 421

NZ 09 477 0492

Trust the expertise of the manufacturer, and rest assured that the repair will be carried out by trained service technicians using original spare parts for your domestic appliance.

Settings table and tips

Notes

- The specified cooking times are only a recommendation. Actual cooking time is influenced by the quality and temperature of the food, its weight and its thickness.
- Always preheat the appliance. This ensures you achieve the best cooking results. The specified cooking times apply to a preheated appliance. They are extended by about 5 minutes if you do not preheat the appliance.
- The data refers to average amounts for four persons. If you would like to prepare more, you should calculate a longer cooking time.
- Use the specified cookware. Cooking times may be lengthened or shortened if you use different cookware.
- Begin with the shortest specified time if you do not have much experience with a dish. If necessary, you can extend the cooking time.
- Pay attention to only opening the oven door of the preheated appliance briefly and to filling the appliance swiftly.
- When using only one cooking container, insert it in the second level from below.
- When steaming, thawing, fermenting and regenerating, you can use up to three insertion levels at the same time (levels 2, 3 and 4 from below). No taste is transferred. Thus, you can prepare fish, vegetables and desserts at the same time. However, the specified cooking times may be extended if you are cooking a large amount of food.
- You can only bake on one level. Use the second level from below.
- The food being cooked must not come into contact with the sides of the cooking compartment, the grease filter or the rear plate.
- The oven door must close well. Therefore, always keep the sealing surfaces clean.
- Do not fill up racks and receptacles too densely. This ensures optimum steam circulation.
- Leave the grease filter inside the appliance during every use.

Vegetables

- Vegetables are prepared more gently in steam than in boiling water. Their taste, color and consistency are preserved better. Vitamins and ingredients that are soluble in water are not washed out. As the steam oven operates without pressure at only 100°C, food is prepared considerably more gently than in a pressure cooker, for example.
- All data refers to 1 kg of cleaned vegetables.
- Use the perforated cooking container to steam vegetables, sliding it into the second level from below. Insert the unperforated cooking container under it. You can collect the vegetable juice and use it as the base for a sauce or a vegetable broth.
- Blanch vegetables for up to four minutes in the preheated appliance. If vegetables or fruits are not served straight away, place them in ice water to prevent simmering in the residual heat.

Food	Cooking container	Temperature in °C	Humidity in %	Cooking time in min.	Remarks
Artichokes, large	Perforated	100	100	25 - 35	
Artichokes, small	Perforated	100	100	15 - 20	
Cauliflower, whole	Perforated	100	100	20 - 25	
Cauliflower, in florets	Perforated	100	100	10 - 20	
Beans, green	Perforated	100	100	20 - 25	
Broccoli, in florets	Perforated	100	100	10 - 15	
Fennel, in strips	Perforated	100	100	10 - 15	
Vegetable terrine	Perforated/ wire rack	100	100	40 - 50	in a terrine form
Carrots, in slices	Perforated	100	100	10 - 15	
Potatoes, peeled and quartered	Perforated	100	100	20 - 35	
Kohlrabi, in slices	Perforated	100	100	15 - 25	

Food	Cooking container	Temperature in °C	Humidity in %	Cooking time in min.	Remarks
Leek, in slices	Perforated	100	100	5 - 10	
Stuffed peppers	Unperforated	180 - 200	80/100	15 - 20	If there is a meat filling, fry the filling beforehand.
Jacket potatoes (about 50 g each)	Perforated	100	100	25 - 30	
Jacket potatoes (about 100 g each)	Perforated	100	100	40 - 45	
Brussels sprouts	Perforated	100	100	15 - 20	
Asparagus, green	Perforated	100	100	10 - 15	
Asparagus, white	Perforated	100	100	18 - 25	
Spinach	Perforated	100	100	4	
Tomatoes, skinned	Perforated	100	100	3 - 4	Cut peel once, place in ice water after steaming.
Sugar snaps	Perforated	100	100	5 - 10	

Fish

- Steaming does not dry out fish and its intrinsic taste and texture are preserved very well.
- For reasons of hygiene, fish and other critical foods should have a core temperature of at least 62 - 65°C after cooking. This is also the ideal cooking point.
- Do not salt fish until after cooking it. This preserves the natural aroma and less water is extracted from the fish.
- When using the perforated cooking container: you can grease it lightly if fish should stick to it too easily.
- Insert the unperforated cooking container in the first level from below to avoid soiling of the oven interior with intensively smelling fish juice.
- In the case of fillets with skin: place the fish with its skin side pointing upward to preserve its structure and aroma.

Food	Cooking container	Temperature in °C	Humidity in %	Cooking time in min.	Remarks
Dorade, whole (700 g)	Unperforated	90 - 100	100	20 - 25	
Fish dumplings (20 - 40 g)	Unperforated	90 - 100	100	5 - 10	Line the unperforated cooking container with baking paper
Lobster, cooked, peeled, regenerating	Perforated	70 - 80	100	10 - 12	
Carp, blue, whole (1.5 kg)	Unperforated	90 - 100	100	40 - 50	in brine
Salmon fillet (300 g each)	Perforated	90 - 100	100	12 - 15	
Salmon, whole (2.5 kg)	Perforated	100	100	70 - 80	
Mussels (1.5 kg)	Perforated	100	100	8 - 12	The mussels are done once the shells have opened.
Hake, whole (800 g)	Perforated	90 - 100	100	20 - 25	
Monkfish fillet (300 g each)	Glass dish/ wire rack	180 - 200	100	10 - 12	in juice
See bass, whole (400 g)	Perforated	90 - 100	100	15 - 20	

Fish – low-temperature steaming

- When steamed at between 70 and 90°C, fish does not overcook and fall apart so easily. This is particularly advantageous for sensitive fish.
- The data for the various fish types refers to fillets.
- Insert the unperforated cooking container in the first level from below to avoid soiling of the cooking compartment with intensively smelling fish juice.
- Serve on preheated cookware.

Food	Cooking container	Temperature in °C	Humidity in %	Cooking time in min.	Remarks
Oysters (10 oysters)	Unperforated	80 - 90	100	2 - 5	in brine
Tilapia (150 g each)	Perforated	80 - 90	100	10 - 12	
Bream (200 g each)	Perforated	80 - 90	100	12 - 15	
Fish fillet (200 - 300 g each)	Perforated	80 - 90	100	12 - 15	
Fish terrine	Wire rack	70 - 80	100	50 - 90	in terrine form
Trout, whole (250 g each)	Perforated	80 - 90	100	12 - 15	
Halibut (300 g each)	Perforated	80 - 90	100	12 - 15	
Scallops (6 scallops)	Unperforated	80 - 90	100	4 - 8	
Cod (250 g each)	Perforated	80 - 90	100	10 - 12	
Red snapper (200 g each)	Perforated	80 - 90	100	12 - 15	
Ocean perch (120 g each)	Perforated	80 - 90	100	10 - 12	
Monkfish (200 g each)	Perforated	80 - 90	100	10 - 15	
Rolled sole fillets (80 - 150 g each)	Perforated	80 - 90	100	12 - 15	
Turbot (300 g each)	Perforated	80 - 90	100	12 - 15	
Sea bass (150 g each)	Perforated	80 - 90	100	10 - 12	
Pike-perch (250 g each)	Perforated	80 - 90	100	12 - 15	







Meat – cooking at higher temperatures

- The combination of steam and hot air is the optimum cooking process for many types of meat. In this mode of operation, the cooking compartment is sealed hermetically and moisture prevents the drying-out effect of the conventional hot air oven. Thanks to variable humidity control, you can achieve the optimum climate for every food.
- The cooking times specified are a recommendation and depend very much on the initial temperature of the food and the length of time it is fried. Use the core temperature probe for better control. You will find notes and optimum target temperatures in the section entitled *Core temperature probe*.
- Take meat out of the fridge one hour before preparing it.
- When using the perforated cooking container or the wire rack, insert an unperforated cooking container underneath it. Pour some water into the unperforated cooking container to prevent baking in. You can also insert vegetables, wine, spices and herbs to prepare a tasty base for sauces.
- If you would like to cook meat rare or medium-rare: open the door 5°C before the required core temperature has been reached and wait until the target temperature is reached. This prevents overcooking and you give the meat the time it needs to settle.
- Letting meat settle: let the meat settle for another 10-15 minutes after cooking. In this way, the meat can "relax". Circulation of the meat juice diminishes and there are fewer losses of juice when cutting open the meat.

Food	Cooking container	Temperature in °C	Humidity in %	Cooking time in min.	Remarks
Entrecôte, browned, medium-rare (350 g each)	Unperforated	170 - 180	30	10 - 20	
Filet, browned, medium-rare, in puff pastry (600 g)	Unperforated	180 - 200	80/100	30 - 45	Line the cooking container with baking paper
Back of veal, browned, medium-rare (1 kg)	Unperforated	160 - 180	30/60	20 - 30	30 % humidity is sufficient when liquid is added to the unperforated cooking container.
Smoked pork chops, cooked, in slices	Unperforated	100	100	15 - 20	
Roast pork with crust, well-done (1.5 kg)	Rack	1) 120 2) 150 - 160 3) 220 - 230	100 60/80 0	30 25 - 40 15 - 30	Cut into the crust crosswise before cooking. Use the core temperature probe: in the second cooking step, you should achieve a core temperature of about 65°C to cook the meat in the third step up to a core temperature of 75 - 80 °C.
Leg of lamb, browned, medium-rare (1.5 kg)	Unperforated	170 - 180	30/60	60 - 80	
Back of venison, browned, medium-rare (500 g each)	Unperforated	160 - 180	0/30	12 - 18	
Beef roast, well-done (1.5 kg)	Rack	1) 210 - 230 2) 140 - 160	100 30/60	15 - 20 60 - 90	30 % humidity is sufficient when liquid is added to the unperforated cooking container.
Roast beef, browned, medium-rare (1 kg)	Unperforated	160 - 180	0/30	40 - 60	
Roast pork (neck or shoulder), well-done (1.5 kg)	Rack	1) 220 - 230 2) 160 - 170	100 30/60	10 60 - 90	30 % humidity is sufficient when liquid is added to the unperforated cooking container.
Heating up (boiled) sausage	Unperforated	85 - 90	100	10 - 20	e.g. Bavarian veal sausage ('Weisswurst') or 'Lyoner' pork sausage

Meat/poultry – low-temperature cooking

- Vigorously browned meat matures over a longer time at a lower temperature. As a result, the meat evenly becomes gentle pink and extraordinarily juicy apart from a very thin edge. And it is neither necessary to turn the meat nor pour juice over it.
- The cooking times specified are only a recommendation and depend very much on the initial temperature of the food and the length of time it is browned. Use the core temperature sensor for better control. You will find notes and optimum target temperatures in the section entitled *Core temperature sensor*.
- Take meat out of the fridge one hour before preparing it.
- For hygienic reasons, sear the meat briefly at a high temperature in the pan from all sides before cooking it. As a result, a crust is produced that prevents leaking of the meat juice and ensures a typical roast aroma.
- Season carefully: slow maturing of the meat boosts all aromas.
- Venison and horse meat tastes stronger after low-temperature cooking than when prepared by classical methods.
- Use the "Low-temperature cooking" mode . Thus, the moisture escaping from the food stays in the cooking compartment and prevents drying out of prepared foods.
- Please note that you cannot achieve any core temperatures above the cooking compartment's temperature. As a rule of thumb: the set oven temperature should be 10-15°C above the desired core temperature.
- You can reduce the temperature to 60°C towards the end of the cooking time. Thus, you can prolong the cooking time (for example, if guests arrive late). If you want to stop the cooking process, the interior temperature must not be higher than the desired core temperature. Thus, large pieces can stay in the oven for 1 - 1.5 hours, while small pieces can stay there for 30 - 45 minutes.
- Serve food on preheated cookware.

Food	Cooking container	Temperature in °C	Heating mode	Cooking time in min.	Remarks
Duck breast, medium-rare (350 g each)	Unperforated	70 - 80		40 - 60	
Entrecôte, medium-rare (350 g each)	Unperforated	70 - 80		40 - 70	
Leg of lamb, without bones, tied, medium-rare (1.5 kg)	Unperforated	70 - 80		180 - 240	
Roast beef, medium-rare (1 - 1.5 kg)	Unperforated	70 - 80		150 - 210	
Medallions of pork, well-done (70 g)	Unperforated	80		50 - 70	
Beefsteaks, medium-rare (200 g)	Unperforated	70 - 80		30 - 60	

Poultry

- The humidity during combined operation prevents drying out which, especially in the case of poultry, is crucial. At the same time, the high temperature lends crispy browning to the surface. The heat transmitted by the hot steam is twice as high as in the case of conventional hot air and it reaches all parts of the food. This is why a chicken becomes browned and crispy all-round, and nevertheless the breast meat stays tender and juicy.
- The cooking times specified are a recommendation and depend very much on the initial temperature of the food. Use the core temperature probe for better control. Do not place it in the middle (cavity), but between the belly and the thigh. You will find further notes and optimum target temperatures in the section entitled *Core temperature probe*.
- If you season poultry mainly with spices and with little or no oil, the skin will become crispier.

Food	Cooking container	Temperature in °C	Humidity in %	Cooking time in min.	Remarks
Duck, whole (3 kg)	Unperforated	1) 150 - 160 2) 220	60 0	80 - 90 20 - 30	Start cooking with the breast pointing down. Turn the duck round after half of the cooking time. In this way, the sensitive breast meat will not dry out so much.
Duck breast, browned, medium-rare (350 g each)	Unperforated	160 - 180	0	8 - 15	
Chicken, whole (1.5 kg)	Wire rack	1) 170 - 180 2) 220	60 0	30 - 45 15 - 20	
Chicken breast, stuffed, steamed (200 g each)	Perforated	100	100	10 - 15	
Turkey breast fillet, steamed (300 g each)	Perforated	100	100	12 - 15	
Spring chicken, quail, pigeon (300 g)	Perforated	100	100	25 - 30	
Spring chicken, quail, pigeon (300 g)	Perforated	180 - 200	60/80	12 - 16	

Side dishes

Observe the manufacturer's recommendations.

Food	Cooking container	Temperature in °C	Humidity in %	Cooking time in min.	Remarks
Basmati rice (250 g + 500 ml of water)	Unperforated	100	100	20 - 25	
Cous-cous (250 g + 250 ml of water)	Unperforated	100	100	5 - 10	
Potato gratin (1.5 kg of potatoes)	Unperforated	180 - 200	0/30	35 - 50	
Dumplings (90 g each)	Perforated/ unperforated	95 - 100	100	20 - 25	
Long grain rice (250 g + 500 ml of water)	Unperforated	100	100	25 - 30	
Rice (250 g + 375 ml of water)	Unperforated	100	100	30 - 40	
Lentils (250 g + 500 ml of water)	Unperforated	100	100	25 - 35	
Fresh pasta, cooled	Perforated	100	100	5 - 7	
Fresh pasta, with filling, cooled	Perforated	100	100	7 - 10	
White beans, pre-soaked (250 g + 1 l of water)	Unperforated	100	100	55 - 65	





Desserts

Food	Cooking container	Temperature in °C	Humidity in %	Cooking time in min.	Remarks
Crème Brûlée (130 g each)	Perforated	90 - 95	100	35 - 40	in soufflé dishes, covered with heat-resistant cling film
Yeast dumplings (100 g each)	Unperforated	100	100	20 - 30	Leave yeast dumplings to rise for 30 min. before steaming (see section entitled <i>Dough proofing</i>).
Flan/Crème Caramel (130 g each)	Perforated	90 - 95	100	25 - 30	in soufflé dishes, covered with heat-resistant cling film
Compote	Unperforated	100	100	5 - 15	e.g. apples, pears, rhubarb Add sugar, vanilla sugar, cinnamon or lemon juice to taste.
Milk rice (250 g of rice + 625 ml of milk)	Unperforated	100	100	35 - 45	Add fruit, sugar or cinnamon to taste.
Baked puddings	Unperforated	180 - 200	0/60	20 - 40	e.g. semolina, curd cheese or precooked rice pudding

Miscellaneous

Food	Cooking container	Temperature in °C	Humidity in %	Cooking time in min.	Remarks
Disinfecting (e.g. baby bottles, jam jars)	Wire rack	100	100	20 - 25	
Drying fruit or vegetables	Perforated	80 - 100	0	180 - 300	e.g. tomatoes, mushrooms, zucchini, apples, pears, etc. in thin slices
Eggs, size M (5 eggs)	Perforated	100	100	8 - 15	
Cooked-egg garnish (500 g)	Glass mould, wire rack	90	80 - 100	25 - 30	Cover with heat-resistant transparent film
Semolina dumplings	Unperforated	90 - 95	100	8 - 10	
Lasagne	Unperforated	170 - 190	0 /60	35 - 60	
Soufflé	Soufflé dishes, wire rack	180 - 200	60	12 - 20	

Baking

- Using the steam oven, you can prepare your baked items with the optimum humidity:
 -  | Hot air + 0% humidity: moisture can escape in the case of fruit cakes and quiche. This mode corresponds to hot air in the conventional oven.
 -  | Hot air + 30% humidity: mixed cake does not dry out. The intrinsic humidity in a food cannot escape from the oven interior.
 -  -  | Hot air + 60 - 100% humidity: puff pastry and yeast-risen pastries become looser on the inside and crispy on the outside with a gloss.
- You can only bake on one level in the steam oven. Insert the unperforated cooking container into the second level from below. When using a high baking tin, place it on the wire rack, which you then insert in the first level from below.
- Always leave the grease filter in place when baking.
- Misting brings additional steam to the food during baking with Hot air + 0% humidity or with Hot air + 30% humidity when touching the  symbol. Use the misting function for example when baking bread at the beginning of the baking time. The bread will increase in volume and will get a crispy crust.

Food	Cooking container	Temperature in °C	Humidity in %	Cooking time in min.	Remarks
Apple pie	20 cm spring release cake tin, wire rack	165 - 175	0	70 - 80	
Bagels	Unperforated	190 - 210	80 - 100	20 - 25	
Baguette, pre-baked	Wire rack	190 - 200	0 - 80	10 - 15	
Biscuit base, high (6 eggs)	Spring release cake tin	160 - 170	0	30 - 35	
Swiss roll (2 eggs)	Unperforated	190 - 210	0 - 30	8 - 11	
Small flaky pastry cakes	Unperforated	190 - 210	80 - 100	12 - 20	
Bread rolls (50 - 100 g each)	Unperforated	190 - 210	80 - 100	15 - 25	Bread rolls can be successfully baked as follows: preheat at 220°C and 30 % moisture. After placing them in the oven, use 'misting' once or twice. After 5 minutes reduce to 0 % moisture and 190°C.
Bread rolls, pre-baked	Wire rack	150 - 170	0	8 - 15	use 'misting' at the beginning
Bread (1 - 1.5 kg)	Unperforated	1) 210 - 230 2) 165	30 0	15 - 20 35 - 50	use 'misting' two or three times at the beginning
Square sponge cake	Unperforated	160 - 175	0	25 - 40	
"Gugelhupf"	Gugelhupf tin, wire rack	160 - 175	30 - 60	35 - 45	yeast dough from 1 kg of flour
Yeast tray bake	Unperforated	160 - 170	0 - 60	30 - 45	Use 0% humidity for yeast tray bakes with a moist topping (e.g. plum cake or onion tart) and 60% humidity for a dry topping (e.g. crumble).
Brioche (500 g of flour)	Unperforated	160 - 170	60 - 80	25 - 35	
Muffins	Muffin tray, wire rack	170 - 180	0 - 30	20 - 30	
Macaroons	Unperforated	150 - 175	0	10 - 20	
Biscuits	Unperforated	150 - 170	0	15 - 25	
Quiche, tart	Flan tin, wire rack	190 - 210	0	45 - 60	
Sponge cake	Cake tin/spring release cake tin, wire rack	160 - 175	0 - 30	50 - 60	
Small cakes	Unperforated	150 - 160	0	35 - 45	
Piped biscuits	Unperforated	150 - 160	0	25 - 30	
Tart	Flan tin, wire rack	190 - 210	0 - 30	30 - 45	
Cream puffs, eclairs	Unperforated	180 - 190	0 - 30	40 - 45	

Regenerating (reheating)

- In the steam oven, you can generate the optimum climate for heating ready-cooked meals without them drying out. Thus, taste and quality are preserved, and meals taste like freshly prepared.
- Use the "Regenerating" mode  to do this.
- The data refers to portions for one person. You can also warm up large quantities in the unperforated cooking container. The specified times are lengthened.

Food	Cooking container	Temperature in °C	Cooking time in min.	Remarks
Baguette, bread rolls (frozen)	Wire rack	140	8 - 12	
Baguette, bread rolls (from the day before)	Wire rack	180	4 - 8	
Vegetables	Plate, wire rack	90 - 100	7 - 10	
Starch-based side dishes	Plate, wire rack	120	7 - 10	e.g. pasta, potatoes, rice; baked or deep fried food such as french fries or croquettes are not suitable
Plated meals	Plate, wire rack	120	8 - 15	
Pizza, deep-pan	Wire rack	180	8 - 10	
Pizza, thin base	Wire rack	180	4 - 6	

Raising dough

- The steam oven offers the ideal climate for raising dough and dough mixtures or dough pieces without drying them out.
- Use the "Dough proofing" mode  to do this.
- It is not necessary to cover the bowl with a moist cloth. Raising only takes half as much time as it used to.
- The specified dough proofing time is a recommendation only. Raise dough until its volume has doubled.

Food	Cooking container	Temperature in °C	Cooking time in min.	Remarks
Dough mixture	Bowl/wire rack	38	25 - 45	e.g. yeast dough, baking ferment and sour dough

Defrosting

- In the steam oven you can gently and evenly defrost deep frozen food faster than at room temperature.
- Use the "Defrosting" mode * δ to do this.
- The specified defrosting times are only a recommendation. The time it takes to defrost depends on the size and weight of the frozen food: freeze your food flatly or individually. This shortens the defrosting time.
- Remove the packaging before defrosting.
- Defrost only the quantity you need for preparation.
- Remember: once defrosted, food will not keep for as long and spoils more quickly than fresh food. Immediately process defrosted food and cook it thoroughly.
- After half of the defrosting time, turn meat or fish over. Separate frozen pieces of food such as berries or bits of meat. It is not necessary to fully defrost fish. It will be sufficiently thawed if the tissue is soft enough to absorb the spices.

Health risk!

When defrosting food from animal sources, you must remove the liquid that escapes during defrosting. It must never come into contact with other food.

Bacteria could be transferred.

Slide the unperforated cooking container underneath the food. Pour away the collected thawing liquid from meat and poultry. Then clean the sink and rinse with plenty of water. Clean the cooking container in hot soapy solution or in a dishwasher.

After defrosting, operate the steam oven for 15 minutes using Hot air at 180°C.

Food	Cooking container	Temperature in °C	Heating mode	Cooking time in min.	Remarks
Berries (300 g)	Perforated	45 - 50	* δ	3 - 4	
Roast (1,000 g)	Perforated	45 - 50	* δ	45 - 60*	
Fish fillet (150 g each)	Perforated	45 - 50	* δ	5 - 10*	
Vegetables (400 g)	Perforated	45 - 50	* δ	5 - 7	
Goulash (600 g)	Perforated	45 - 50	* δ	30 - 45*	
Chicken (1,000 g)	Perforated	45 - 50	* δ	45 - 60*	
Chicken leg (400 g each)	Perforated	45 - 50	* δ	30 - 35*	

* You should add some extra time for this dish: switch off the appliance after the defrosting time has elapsed and leave dishes in the closed appliance for another 10 - 15 minutes so that they can thaw completely to their interior.

Preserving

- In the steam oven, you can preserve fruit and vegetables without much effort.
- Preserve food which is as fresh as possible. When foods are stored for a relatively long period, their vitamin content is reduced and they ferment and spoil more easily.
- Use only fruit and vegetables that are in perfect state.
- The steam oven is not suitable for preserving meat.
- Check and thoroughly clean preserving jars, rubber rings, clamps and springs.
- Disinfect rinsed jars before preserving in your steam oven at 100 °C and 100% humidity for 20-25 minutes.
- Place the jars in the perforated cooking container. They must not be in contact with each other.
- After the specified cooking time, open the appliance door. Do not remove the preserving jars from the appliance until they have completely cooled down.

Food	Cooking container	Temperature in °C	Humidity in %	Cooking time in min.	Remarks
Fruit and vegetables (in closed 0.75 l preserving jars)	Perforated	100	100	35 - 40	
Beans and peas (in closed 0.75 l preserving jars)	Perforated	100	100	120	

Extracting juice (soft fruit)

- You can effortlessly and cleanly extract berry juice in the steam oven.
- Place the berries in the perforated cooking container and slide it into the third level from below. Slide in the unperforated cooking container one level below it to collect the juice.
- Leave the berries in the appliance until no more juice appears.
- Finally, place the berries in a cloth and squeeze out the rest of the juice.

Food	Cooking container	Temperature in °C	Humidity in %	Cooking time in min.	Remarks
Berries	Perforated + unperforated	100	100	60 - 120	

Preparing yoghourt

- You can prepare your own yoghourt in the steam oven.
- Heat up pasteurized milk to 90°C on the cooktop to avoid disturbing the yoghourt cultures. Long-life milk (UHT milk) does not need heating. (Note: if you produce yoghourt with cold milk, this will prolong the maturation time.)
- Important! Allow the milk to cool to 40°C in a water bath to avoid destroying the yoghourt cultures.
- Stir natural yoghourt with declared yoghourt cultures into the milk (1 - 2 teaspoons of yoghourt for every 100 ml).
- In the case of yoghourt ferment, pay attention to the notes on the packaging.
- Pour the yoghourt into rinsed jars.
- You can disinfect the rinsed jars in your steam oven at 100°C and 100% humidity for 20 - 25 minutes before pouring in the yoghourt. Make sure you allow the jars and the oven interior to cool down before you pour the yoghourt into the jars and place the jars in the appliance.
- After preparing it, place the yoghourt in the fridge.
- To get firm yoghourt, add skimmed milk powder (1 - 2 tablespoons per liter) to the milk before heating it.

Food	Cooking container	Temperature in °C	Humidity in %	Cooking time in min.	Remarks
Yoghourt mixture (in sealed jars)	unperforated	45	100	240 - 360	

Preparing bulky food

- You can remove the side slide-in rails to prepare bulky food.
- To do this, undo the knurled nuts on the front of the slide-in rails and pull out the rails toward you (see section entitled *Removing slide-in rails*).
- Place the wire rack directly on the bottom of the cooking compartment and then place the food or the roaster on the rack. Do not place the food or the roaster directly on the bottom of the cooking compartment.

Gaggenau Hausgeräte GmbH
Carl-Wery-Straße 34
D-81739 München
www.gaggenau.com

GAGGENAU



9000909962 en (930529)