

BM 450/451

BM 454/455

BM 484/485

Combi-microwave oven

Table of contents

Important safety information	3
Causes of damage	5
Environmental protection	6
Environmentally-friendly disposal	6
Tips for saving energy	6
Getting to know the appliance	6
Display and operating controls	6
Function selector positions	7
Symbols	7
Colours and display	8
Automatic door opening	8
Additional information i	8
Cooling fan	8
Accessories	8
Special accessories	9
Before using for the first time	9
Setting the language	9
Setting the time format	10
Setting the clock	10
Setting the date format	10
Setting the date	10
Setting the temperature format	10
Ending initial set-up	10
Heating up the oven	11
Cleaning accessories	11
Activating the appliance	11
Standby	11
Activating the appliance	11
Microwave	12
Notes regarding ovenware	12
Microwave power setting	12
Setting the microwave	12
Oven	13
Setting the heating function and temperature	13
Rapid heating	13
Safety shut-off	13
Full surface grill	14
Setting the full surface grill	14
Combination mode	14
Setting the combination mode	14
Sequential operation	15
Setting sequential operations	15
End of cooking time	16
Automatic programmes	17
Setting a programme	17
Individual adjustment	18
Instructions for automatic programmes	18

Programme table	19
Individual recipes	21
Recording a recipe	21
Programming a recipe	21
Entering names	22
Starting recipes	22
Change recipe	22
Deleting recipes	23
Timer functions	23
Calling up the timer menu	23
Timer	23
Stopwatch	23
Long-term timer	24
Child lock	25
Activate the child lock	25
Deactivating the child lock	25
Basic settings	25
Cleaning	28
Self-cleaning surface in the cooking compartment	28
Cleaning agents	28
Trouble shooting	29
Power cut	30
Demo mode	30
Replacing the oven light bulb	30
Technical data	31
After-sales service	31
E number and FD number	31
Settings table and tips	32
Defrosting	32
Defrosting and heating up or cooking frozen food	33
Heating food	34
Cooking food	34
Microwave tips	35
Cakes and pastries	35
Baking tips	36
Roasting and grilling	37
Tips for roasting and grilling	39
Bakes, gratins	39
Frozen convenience products	39
Test dishes	40
Acrylamide in foodstuffs	41

Additional information on products, accessories, replacement parts and services can be found at **www.gaggenau.com** and in the online shop **www.gaggenau.com/zz/store**

⚠ Important safety information

Read these instructions carefully. Only then will you be able to operate your appliance safely and correctly. Retain the instruction manual and installation instructions for future use or for subsequent owners.

This appliance is only intended to be fully fitted in a kitchen. Observe the special installation instructions.

Check the appliance for damage after unpacking it. Do not connect the appliance if it has been damaged in transport.

Only a licensed professional may connect appliances without plugs. Damage caused by incorrect connection is not covered under warranty.

This appliance is intended for domestic use only. The appliance must only be used for the preparation of food and drink. The appliance must be supervised during operation. Only use this appliance indoors.

This appliance is intended for use up to a maximum height of 4000 metres above sea level.

This appliance may be used by children over the age of 8 years old and by persons with reduced physical, sensory or mental capabilities or by persons with a lack of experience or knowledge if they are supervised or are instructed by a person responsible for their safety how to use the appliance safely and have understood the associated hazards.

Children must not play with, on, or around the appliance. Children must not clean the appliance or carry out general maintenance unless they are at least 8 years old and are being supervised.

Keep children below the age of 8 years old at a safe distance from the appliance and power cable.

Always slide accessories into the cooking compartment correctly. See description of accessories in the instruction manual.

Risk of fire!

- Combustible items stored in the cooking compartment may catch fire. Never store combustible items in the cooking compartment. Never open the appliance door if there is smoke inside. Switch off the appliance and unplug it from the mains or switch off the circuit breaker in the fuse box.

- Using the appliance for anything other than its intended purpose is dangerous and may cause damage.

The following is not permitted: drying out food or clothing, heating slippers, grain or cereal pillows, sponges, damp cleaning cloths or similar.

For example, heated slippers and grain or cereal pillows may catch fire, even several hours after they have been heated. The appliance must only be used for the preparation of food and drinks.

- Food may catch fire. Never heat food in heat-retaining packages.

Do not leave food heating unattended in containers made of plastic, paper or other combustible materials.

Do not select a microwave power or time setting that is higher than necessary. Follow the information provided in this instruction manual.

Never use the microwave to dry food.

Never defrost or heat food with a low water content, e.g. bread, at too high a microwave power or for too long.

- Cooking oil may catch fire. Never use the microwave to heat cooking oil on its own.

Risk of explosion!

Liquids and other food may explode when in containers that have been tightly sealed. Never heat liquids or other food in containers that have been tightly sealed.

Risk of serious damage to health!

- The surface of the appliance may become damaged if it is not cleaned properly. Microwave energy may escape. Clean the appliance on a regular basis, and remove any food residue immediately. Always keep the cooking compartment, door seal, door and door stop clean; refer also to Cleaning section.
- Microwave energy may escape if the cooking compartment door or the door seal is damaged. Never use the appliance if the cooking compartment door or the door seal is damaged. Contact the after-sales service.
- Microwave energy will escape from appliances that do not have any casing. Never remove the casing. For any maintenance or repair work, contact the after-sales service.

Risk of electric shock!

- Incorrect repairs are dangerous. Repairs may only be carried out and damaged power cables replaced by one of our trained after-sales technicians. If the appliance is defective, unplug the appliance from the mains or switch off the circuit breaker in the fuse box. Contact the after-sales service.
- The cable insulation on electrical appliances may melt when touching hot parts of the appliance. Never bring electrical appliance cables into contact with hot parts of the appliance.
- Do not use any high-pressure cleaners or steam cleaners, which can result in an electric shock.
- When replacing the cooking compartment bulb, the bulb socket contacts are live. Before replacing the bulb, unplug the appliance from the mains or switch off the circuit breaker in the fuse box.
- A defective appliance may cause electric shock. Never switch on a defective appliance. Unplug the appliance from the mains or switch off the circuit breaker in the fuse box. Contact the after-sales service.
- The appliance is a high-voltage appliance. Never remove the casing.

Risk of burns!

- The appliance becomes very hot. Never touch the interior surfaces of the cooking compartment or the heating elements. Always allow the appliance to cool down. Keep children at a safe distance.
- Accessories and ovenware become very hot. Always use oven gloves to remove accessories or ovenware from the cooking compartment.
- Alcoholic vapours may catch fire in the hot cooking compartment. Never prepare food containing large quantities of drinks with a high alcohol content. Only use small quantities of drinks with a high alcohol content. Open the appliance door with care.
- Foods with peel or skin may burst or explode during, or even after, heating. Never cook eggs in their shells or reheat hard-boiled eggs. Never cook shellfish or crustaceans. Always prick the yolk when baking or poaching eggs. The skin of foods that have a peel or skin, such as apples, tomatoes, potatoes and sausages, may burst. Before heating, prick the peel or skin.
- Heat is not distributed evenly through baby food. Never heat baby food in closed containers. Always remove the lid or teat. Stir or shake well after the food has been heated. Check the temperature of the food before it is given to the child.
- Heated food gives off heat. The ovenware may become hot. Always use oven gloves to remove ovenware or accessories from the cooking compartment.
- Airtight packaging may burst when food is heated. Always observe the instructions on the packaging. Always use oven gloves to remove dishes from the cooking compartment.

Risk of scalding!

- When you open the appliance door, hot steam may escape. Open the appliance door with care. Keep children at a safe distance.
- Water in a hot cooking compartment may create hot steam. Never pour water into the hot cooking compartment.
- There is a possibility of delayed boiling when a liquid is heated. This means that the liquid reaches boiling temperature without the usual steam bubbles rising to the surface. Even if the container only vibrates a little, the hot liquid may suddenly boil over and spatter. When heating, always place a glass rod/spoon in the container. This will prevent delayed boiling.
- The accessible parts become hot during operation. Never touch the hot parts. Keep children at a safe distance.

Risk of injury!

- Scratched glass in the appliance door may develop into a crack. Do not use a glass scraper, sharp or abrasive cleaning aids or detergents.
- Unsuitable ovenware may crack. Porcelain or ceramic ovenware can have small perforations in the handles or lids. These perforations conceal a cavity below. Any moisture that penetrates this cavity could cause the ovenware to crack. Only use microwave-safe ovenware.
- If using the appliance in microwave mode only, placing cookware and containers made of metal inside the appliance may cause sparks when the appliance is operating. This will damage the appliance. Never use metal containers when using the appliance in microwave mode only. Use only microwave-safe cookware or, alternatively, the microwave in combination with a type of heating.

Causes of damage

Caution!

- Creation of sparks: Metal - e.g. a spoon in a glass - must be kept at least 2 cm from the oven walls and the inside of the door. Sparks could irreparably damage the glass on the inside of the door.
- Water in the cooking compartment when the cooking compartment is hot: Never pour water into the cooking compartment when the cooking compartment is hot. Steam will be created. The temperature change can cause damage to the glass floor panel.
- Foil containers: Do not use foil containers in the appliance. They damage the appliance by producing sparks.
- Moist food: Do not store moist food in the closed cooking compartment for long periods. Do not use the appliance to store food. This can lead to corrosion.
- Cooling with the appliance door open: Only leave the cooking compartment to cool with the door closed. Do not trap anything in the appliance door. Even if the door is only slightly ajar, the fronts of adjacent units may be damaged over time.
- Heavily soiled seal: If the seal is very dirty, the appliance door will no longer close properly during operation. The fronts of adjacent units could be damaged. Always keep the seal clean.
- Transporting the appliance: Do not carry or hold the appliance by the door handle. The door handle cannot support the weight of the appliance and could break.
- Operating the microwave without food: Operating the appliance without food in the cooking compartment may lead to overloading. Never switch on the appliance unless there is food in the cooking compartment. An exception to this rule is a short crockery test (see the section "Microwave, suitable crockery").
- Microwave popcorn: Never set the microwave power too high. Use a power setting no higher than 600 watts. Always place the popcorn bag on a glass plate. The disc may jump if overloaded.

Environmental protection

Environmentally-friendly disposal

Dispose of packaging in an environmentally-friendly manner.



This appliance is labelled in accordance with European Directive 2012/19/EU concerning used electrical and electronic appliances (waste electrical and electronic equipment - WEEE). The guideline determines the framework for the return and recycling of used appliances as applicable throughout the EU.

Tips for saving energy

- Only preheat the oven if this is specified in the recipe or in the operating instructions table.
- Use dark, black lacquered or enamelled baking tins when baking. They absorb the heat particularly well.
- It is best to bake several cakes one after the other. The oven is still warm. This reduces the baking time for the second cake.
- For longer cooking times, you can switch the oven off 10 minutes before the end of the cooking time and use the residual heat to finish cooking.

Getting to know the appliance

Use this section to familiarise yourself with your new appliance. The control panel and the individual operating controls are explained. You will find information on the cooking compartment and the accessories.

Display and operating controls

These instructions are valid for different versions of the appliance. Depending on the appliance model, individual details may differ.

All versions of the appliance are operated in an identical manner.

Operating controls on the upper side of the appliance

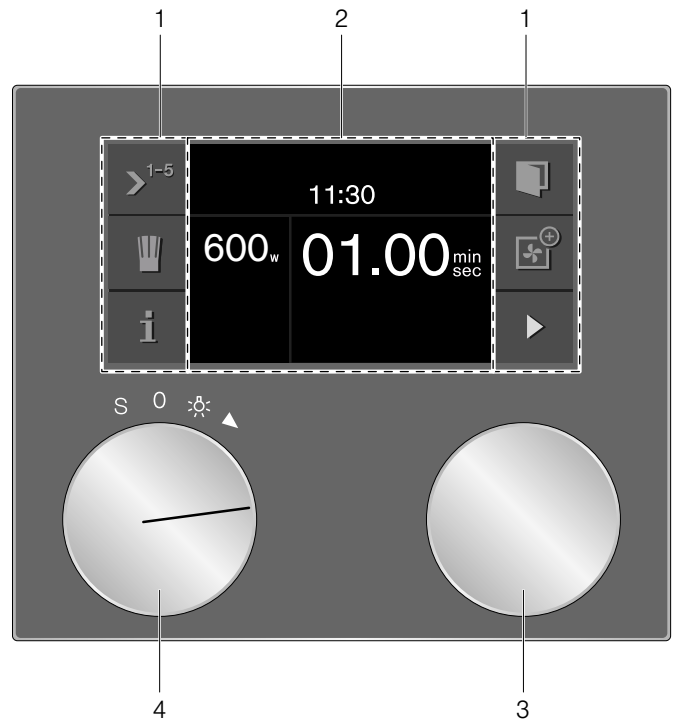

Operating controls on the lower side of the appliance

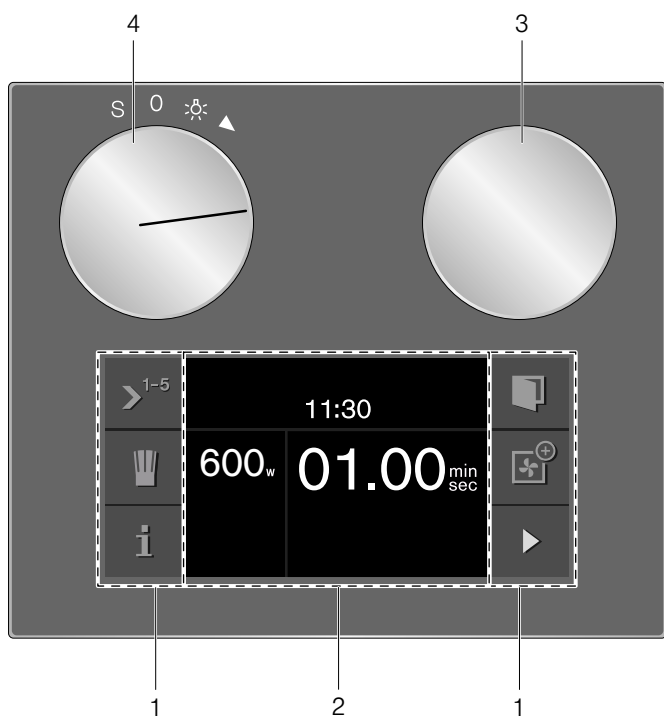

1	Control panel	These areas are touch sensitive. Touch a symbol to select the corresponding function.
2	Display	The display shows, for example, current settings and options.
3	Rotary selector	You can use the rotary selector to make the settings in the different operation modes.
4	Function selector	The function selector is used to select the microwave output, type of heating, basic settings or the light.

Function selector positions

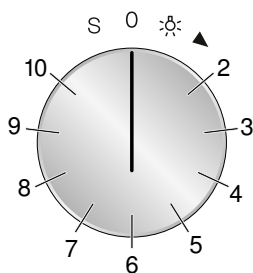

Position	Function
0	Zero setting
Light icon	Light
2	1000 W microwave
3	600 W microwave
4	360 W microwave
5	180 W microwave
6	90 W microwave

Position	Function
7	Hot air
8	Full surface grill + hot air
9	Full surface grill + circulated air
10	Full surface grill
S	Basic settings

Symbols

Symbol	Function
▶	Start
■	Stop
	Pause/End
X	Cancel
C	Delete
✓	Confirm/save settings
>	Selection arrow
🚪	Open appliance door
i	Call up additional information
💬	Call up additional tips
🍷	Call up automatic programmes, individual recipes
↙	Save
✍️	Edit settings
🔒	Child lock
🕒	Call up timer menu
🕒	Call up long-term timer
> ¹⁻⁵	Sequential operation
rec	Record menu
>A ^â	Enter name
✂️	Delete letters
0 _w	Microwave, leave meal to rest
🔪	Demo mode
⤴️	Heating up with status indicator
⤵️	Rapid heating with status indicator
⌚	Timer
🕒	Stopwatch
	Automatic programmes:
🏠	Weight
📺	Cooking result
*	Defrosting
🍲	Cooking, Combi cooking
	Combination mode:
🔥	Call up oven

	Remove oven
	Add oven
	Call up microwave
	Remove microwave
	Add microwave

Colours and display

Colour

The different colours are used to guide the user in the relevant setting situations.

orange	Initial settings Main functions
blue	Basic settings
white	Values which can be set

Display

The appearance of symbols, values and displays changes depending on the situation.

Zoom	Values and symbols that have just been selected are displayed in an enlarged format.
Reduced display screen	After a short time, the display is reduced and only the most important information is displayed. This function is preset and can be changed in the basic settings.

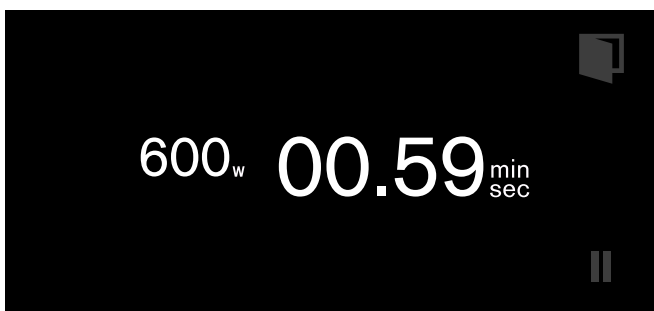

Automatic door opening

The appliance door springs open when you touch the  symbol and you can open it fully by using the recessed handle on the side.

Automatic door opening does not work if the child lock is activated or there is a power cut. You can open the recessed handle on the side by hand.

Additional information

By touching the **i** symbol, you can call up additional information.

Before starting, you are shown information, for example, on the type of heating which has been set. This allows you to check if the current setting is suitable for your meal.

During operation, you are shown information, for example, on the elapsed and remaining time and/or on the current cooking compartment temperature.

Note: Once the oven has heated up, slight deviations in temperature are normal during continuous operation.

Cooling fan

Your appliance has a cooling fan. The cooling fan switches on during operation. The hot air escapes above the door.

The cooling fan continues to run for a certain time after operation.

Caution!

Do not cover the ventilation slots. Otherwise, the appliance will overheat.

Notes

- The appliance remains cool during microwave operation. The cooling fan will still switch on. The fan may run on even when microwave operation has ended.
- Condensation may appear on the door window, interior walls and floor. This is normal and does not adversely affect microwave operation. Wipe away the condensation after cooking.

Accessories

The accessories can be inserted into the appliance at four different heights.

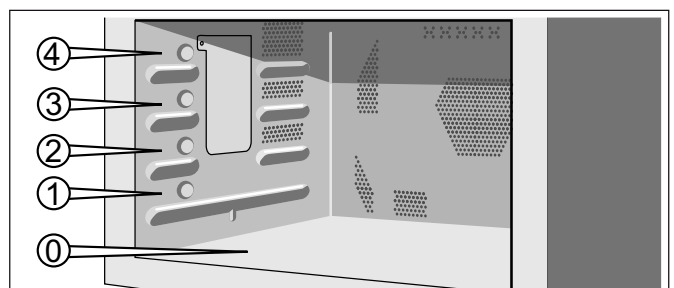

Note: Microwaveable ovenware can be placed on the oven floor (level 0).

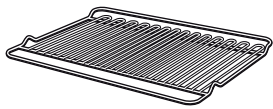

Wire rack

For ovenware, cake tins, grilling and frozen meals.

Note: You can pull the wire rack two thirds of the way out without it tipping. This allows meals to be removed more easily.



Glass tray

For large roasts, moist cakes, bakes and gratins. This can act as a splash guard if you are grilling meat directly on the wire rack. For this, slide the glass tray in at level 1.

The glass tray can also be used as a standing surface during microwave operation.



Glass rod

For heating liquids in narrow containers. It is used to prevent delayed boiling. When heating liquids, always place a glass rod/spoon in the container.

Special accessories

You can order the following special accessories from your specialist dealer:

- BA 476 310 Handle, stainless steel for BM 450/451/454/455
- BA 476 330 Handle, aluminium for BM 450/451/454/455
- BA 478 310 Handle, stainless steel for BM 484/485

Only use the accessories as specified. The manufacturer accepts no liability if these accessories are used incorrectly.

Before using for the first time

Here you will find everything you need to do before using the microwave to prepare food for the first time. First read the section on Safety information.

The appliance must be fully installed and connected to the mains.

After connection to the mains, the "Initial settings" menu appears in the display. You can now make settings for your new appliance.

- Language
- Time format
- Time
- Date format
- Date
- Temperature format

Notes

- The "Initial settings" menu will appear only after the appliance has been connected to a power supply and switched on for the first time, or if the appliance has not been connected to a power supply for a number of days. Once the appliance has been connected to a power supply, the GAGGENAU logo will appear first for approximately 30 seconds. The "Initial settings" menu will then appear automatically.
- You can change the settings at any time (see section entitled 'Basic settings').

Setting the language

The preset language appears in the display.

- 1 Turn the rotary selector to select the required display language.
- 2 Confirm with ✓.

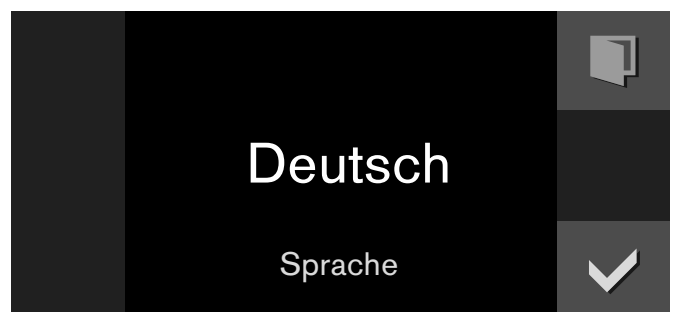

Note: If the language is changed, the system restarts. This takes a few seconds.

Setting the time format

The two possible formats 24h and AM/PM appear in the display. The default is the 24h format.

- 1 Use the rotary selector to select the desired format.
- 2 Confirm with ✓.

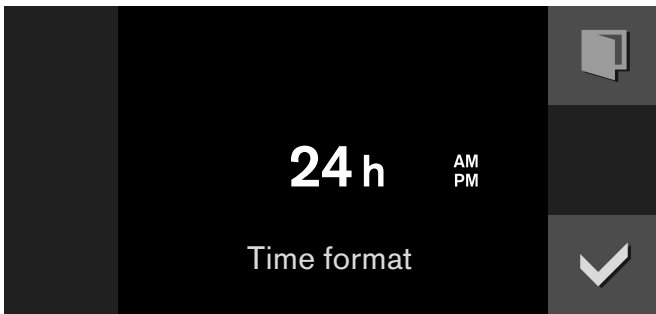

Setting the clock

The time is shown in the display.

- 1 Set the desired time using the rotary selector.
- 2 Confirm with ✓.

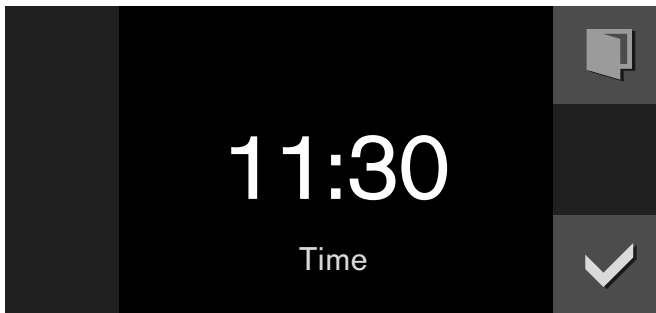

Setting the date format

The three possible formats D.M.Y, D/M/Y and M/D/Y appear in the display. The default is the D.M.Y format.

- 1 Use the rotary selector to select the desired format.
- 2 Confirm with ✓.

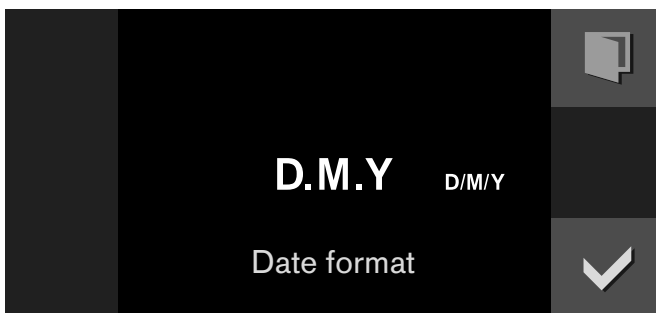

Setting the date

The preset date appears in the display. The day setting is already active.

- 1 Set the day using the rotary selector.
- 2 Touch the > symbol to switch to the month setting.
- 3 Set the month using the rotary selector.
- 4 Touch the > symbol to switch to the year setting.
- 5 Set the year using the rotary selector.
- 6 Confirm with ✓.

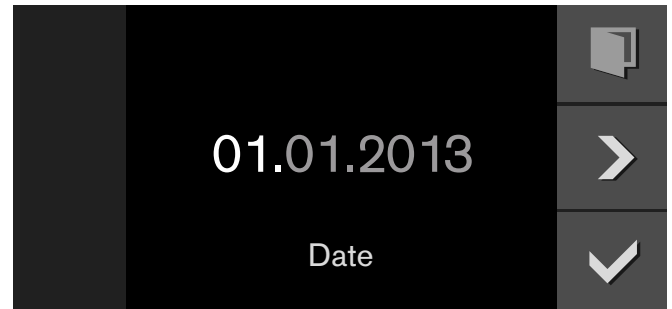

Setting the temperature format

The two possible formats °C and °F appear in the display. The default setting is °C.

- 1 Use the rotary selector to select the desired format.
- 2 Confirm with ✓.

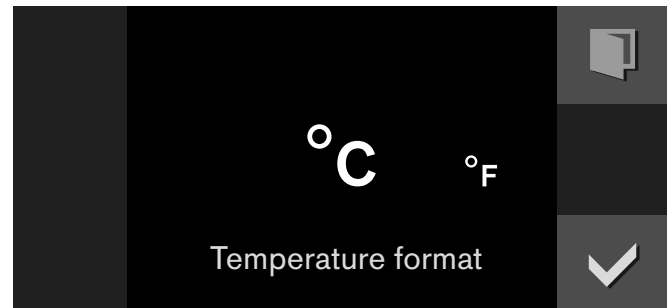

Ending initial set-up

"Initial set-up complete" appears in the display.

Confirm with ✓.

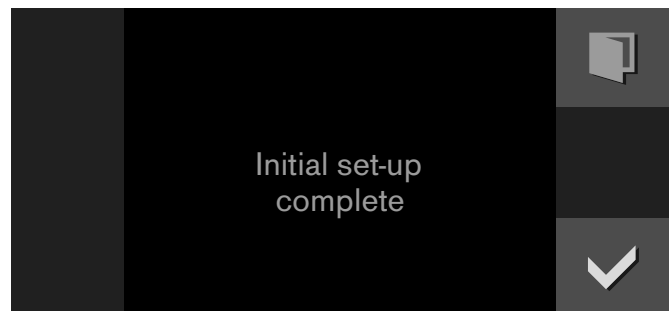

The appliance enters standby mode and the standby screen appears. The appliance is now ready for operation.

Heating up the oven

Ensure that no packaging remnants have been left in the cooking compartment.

To remove the new cooker smell, heat up the oven when it is empty and closed. One hour with  Full surface grill + Hot air at 200 °C is ideal. For instructions on how to set this type of heating, refer to the Oven section.

Cleaning accessories

Before using the accessories for the first time, clean them thoroughly using hot detergent solution and a soft cloth.

Activating the appliance

Standby

The appliance goes into standby mode if no function has been set or the child lock is activated.

The brightness of the control panel is dimmed in standby mode.



Notes

- Different displays are available for standby mode. The default setting is the GAGGENAU logo and the clock. To change the display, refer to the Basic settings section.
- The brightness of the display depends on the vertical viewing angle. You can adjust the display using the "Brightness" setting in the basic settings.

Activating the appliance

To exit standby mode, you can either

- Turn the function selector,
- Touch a control panel,
- Open or close the door.

You can now set the desired function. You can read about how to set functions in the respective chapters.

Notes

- When "Standby screen = off" is selected in the basic settings, you must turn the function selector to exit standby mode.
- The appliance returns to the standby screen if you have not made any settings for a long time after activation.
- When the door is open, the interior lighting switches off after a short time.

Microwave

Microwaves are converted to heat in foodstuffs. The microwave can be used solo, i.e. on its own, or in combination with a different type of heating.

Note: In the Tables and tips section, you will find examples for defrosting, heating and cooking with the microwave oven.

Notes regarding ovenware

Suitable dishes are heat-resistant ovenware made of glass, glass ceramic, porcelain, ceramic or heat-resistant plastic. These materials allow microwaves to pass through. You can also use serving dishes. This saves you having to transfer food from one dish to another. You should only use ovenware with decorative gold or silver trim if the manufacturer guarantees that they are suitable for use in microwaves.

Metal ovenware is unsuitable. Metal reflects microwaves. Food in covered metal containers will remain cold.

Caution!

Metal - e.g. a spoon in a glass - must be kept at least 2 cm from the oven walls and the inside of the door. Sparks could irreparably damage the glass on the inside of the door.

Ovenware test: Do not switch on the microwave unless there is food inside. The following ovenware test is the only exception to this rule. Perform the following test if you are unsure whether your ovenware is suitable for use in the microwave: Heat the empty ovenware at maximum power for between 30 and 60 seconds. Check the temperature of the ovenware during this period. The ovenware should still be cold or warm to the touch. The ovenware is unsuitable if it becomes hot or sparks are generated.

Microwave power setting

The microwave power settings do not always correspond to the exact wattage that the appliance uses.

You can select the following microwave power settings:

90 W	For defrosting delicate foods
180 W	For defrosting and continued cooking
360 W	For cooking meat and heating delicate foods
600 W	For heating and cooking food
1,000 W	For heating liquids

Note: The microwave output can be set to 1000 watts for a maximum of 30 minutes. A duration of 90 minutes is possible with all other output settings.

The maximum setting is for heating liquids. After a certain period, the microwave's power output is reduced to below maximum to protect the appliance. After a cooling period, the microwave's full power will be available once more.

Setting the microwave

- 1 Set the required microwave output setting using the function selector.
- 2 Set the cooking time using the rotary selector.
- 3 Press ► to start.

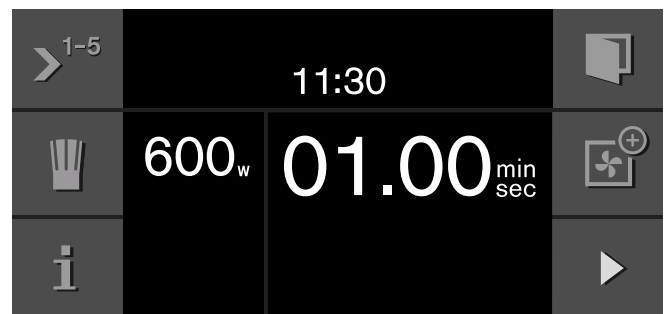

The operation begins. The cooking time starts counting down.

An audible signal sounds once the cooking time has elapsed. The signal stops early if you touch the ✓ symbol, open the appliance door, or set the function selector to 0. The microwave operation has finished.

If you open the oven door during operation, the microwave operation is paused. After closing the door, touch the ► symbol. The operation continues.

You can change the cooking time at any time using the rotary selector.

You can change the output at any time using the function selector. Press ► to restart.

You can call up the elapsed cooking time using the i symbol. Touch the ✓ symbol to return to the standard display.

Pause:

The operation can be paused using the || symbol. Use the ► symbol to continue.

Switching off:

To stop the operation and cancel the settings, turn the function selector to 0.

Note: It is normal for the fan to continue operating even when the door is open.

Oven

In oven mode, you can select from the following types of heating:

Type of heating	Temperature	Use
✿ Hot air	40 °C	Proving yeast dough, defrosting cream cakes
	100-250 °C	Baking cakes, small baked products and pizza on the glass tray
Full surface grill + hot air	100-250 °C	Roasting pieces of meat
Full surface grill + circulated air	100-250 °C	For bakes, toppings and whole poultry

Setting the heating function and temperature

- 1 Use the function selector to set the required heating function, e.g. "Hot air". The ✿ symbol for "Hot air" and the default temperature 180 °C appear in the display.

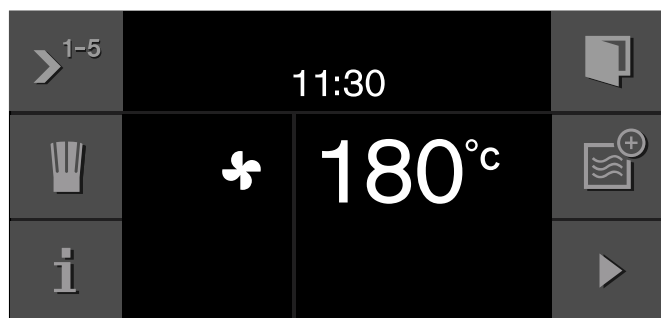

- 2 Set the temperature using the rotary selector.
Note: If required, you can now set the cooking time for your dish and delay the cooking-time end to a later time. Touch the >¹⁻⁵ symbol; the sequential operation menu is displayed. Use > to select and set the ⌚ "Cooking time" function. Use > to select and set the ⌚ "Cooking-time end" function. You can find more detailed information on this in the Sequential operation section.
- 3 Press ▶ to start.

The ⏏ heat-up symbol appears in the display (only after the oven temperature has been set to 100 °C). The bars continuously display the heating status. When the set temperature has been reached, a signal sounds and the ⏏ heat-up symbol goes out.

If the "Rapid heating" function is activated, the >> symbol for "Rapid heating" appears.

Note: You can activate or deactivate a heat-up signal in the basic settings. This signal sounds when the required temperature is reached.

You can change the temperature at any time using the rotary selector.

You can change the heating function at any time using the function selector. Press ▶ to restart.

Pause:

The operation can be paused using the || symbol. Use the ▶ symbol to continue.

Switching off:

To stop the operation and cancel the settings, turn the function selector to 0.

Calling up the current temperature:

Touch the i symbol to display the current oven temperature for several seconds (from 100 °C). Use the ✓ symbol to return to the standard display.

Note: During continuous operation after heating up, slight deviations in temperature are normal, depending on the heating function.

Rapid heating

The "Rapid heating" function brings your appliance to the desired temperature quickly.

To ensure an even cooking result, only put your food in the cooking compartment when the "rapid heating" phase is complete.

You must activate the "Rapid heating" function in the basic settings (refer to the Basic settings section).

Safety shut-off

For your protection, the appliance is equipped with an automatic safety shut-off. Any heating process is switched off after 12 hours if the oven is not operated in this time. A message appears in the display.

Exception:

The long-term timer has been programmed.

Set the function selector to 0, then the appliance can be operated again as usual.

Full surface grill







In grill mode, you can select one of three grill settings:

Heating function	Grill setting	Use
Full surface grill	1 (low)	For soufflés and deep bakes
	2 (medium)	For flat bakes and fish
	3 (high)	For steaks, sausages and toast

Setting the full surface grill

- 1 Use the function selector to set the full surface grill.
The  full surface grill symbol and grill setting 3 appear in the display.





- 2 Use the rotary selector to set the grill setting.
Note: If required, you can now set the cooking time for your dish and delay the cooking-time end to a later time. Touch the  symbol; the sequential operation menu is displayed. Use  to select and set the  "Cooking time" function. Use  to select and set the  "Cooking-time end" function. You can find more detailed information on this in the Sequential operation section.
- 3 Press  to start.

You can change the grill setting at any time using the rotary selector.

You can change the operation mode at any time using the function selector. Press  to restart.

Pause:

The operation can be paused using the  symbol. Use the  symbol to continue.

Switching off:

To stop the operation and cancel the settings, turn the function selector to 0.

Combination mode

In combination mode, an oven heating function or the full surface grill are operated at the same time as the microwave. This enables your meals to be cooked more quickly while still being nicely browned.



You can use all of the microwave output settings. Exception: 1000 watts.

You can also combine the selected heating function with the microwave's sequential operation.

Setting the combination mode

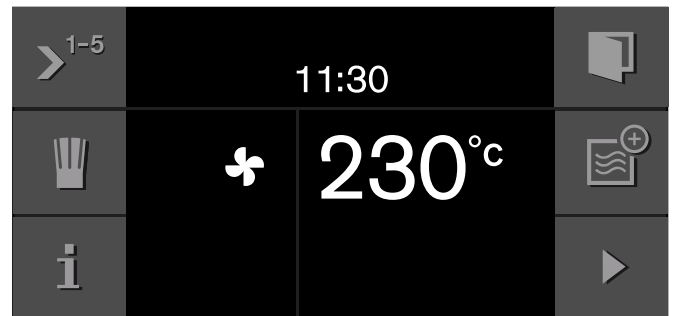
- 1 Use the function selector to select the required oven heating function or microwave output.
Note: You can start the combination mode with an oven heating function or microwave output. In the following example, it is started with an oven heating function.
- 2 Set the oven temperature or grill setting using the rotary selector.



Depending on the operation mode selected, the  symbol for microwave or the  symbol for oven appears in the right-hand control panel, which enables you to add the other relevant operation mode.

- 3 Add a microwave output setting using the  symbol.
- 4 Set the required microwave output setting using the function selector.
- 5 Set the cooking time using the rotary selector.

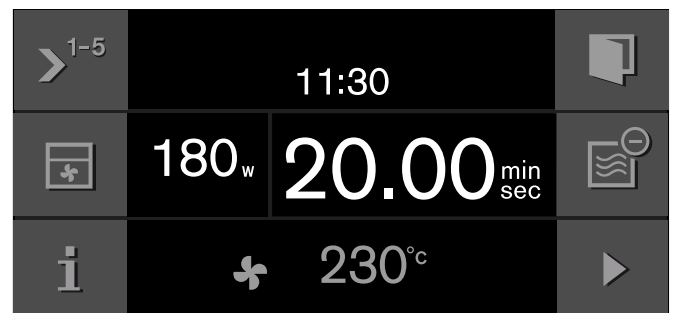

- 6 Press  to start.

The operation begins. The cooking time starts counting down.

An audible signal sounds once the cooking time has elapsed. The signal stops early if you touch the ✓ symbol, open the appliance door, or set the function selector to 0. The combination mode has finished.

Changing settings

You can change the oven heating function and oven temperature, the grill setting or the microwave output setting and cooking time. The changes can also be made during the operation; to do this, touch the || symbol. The operation stops.

- 1 Choose the operation mode using the ☰ or ☱ symbols.
- 2 Use the function selector to change the oven heating function or the microwave output setting.
- 3 Use the rotary selector to change the oven temperature, grill setting, or the duration of the microwave output setting.
- 4 Press ▶ to start.

Cancelling settings

You can also delete the settings during the operation; to do this, touch the || symbol. The operation stops.

- 1 Choose the operation mode using the ☰ or ☱ symbols.
- 2 Cancel the heating function using the ☰ or ☱ symbols.
- 3 Press ▶ to start.

Pause:

The operation can be paused using the || symbol. Use the ▶ symbol to continue.

Switching off:

To stop the operation and cancel the settings, turn the function selector to 0.

Sequential operation

With sequential operation, you can set up to five different types of heating and cooking times to run one after the other.

Setting sequential operations

- 1 Select the required microwave output or oven heating function using the function selector.

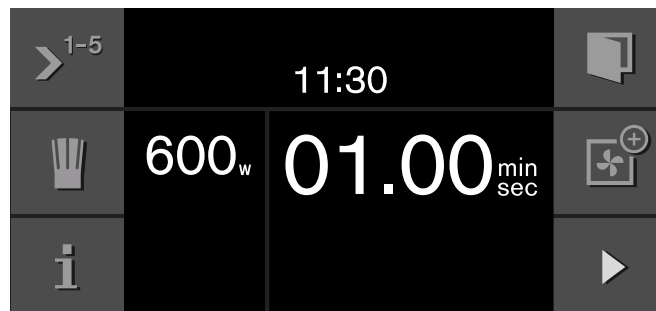

- 2 Touch the >¹⁻⁵ symbol. The sequential operation menu is displayed.
- 3 Set the cooking time, temperature or grill setting using the rotary selector.

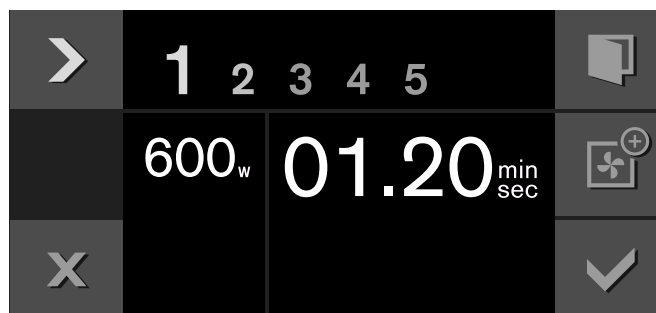

- 4 Use > to select the second phase.
- 5 Select the required microwave output or oven heating function using the function selector. Set the cooking time, temperature or grill setting using the rotary selector.

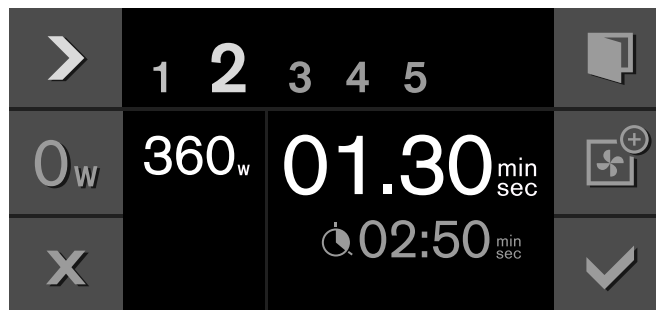

Note: You can set a stabilisation time between two microwave outputs so that the temperature is distributed evenly within the food. To do this, touch the 0_w symbol and set a time using the rotary selector.

- 6 Use > to select the third phase.
- 7 Select the required microwave output or oven heating function using the function selector. Set the cooking time, temperature or grill setting using the rotary selector.

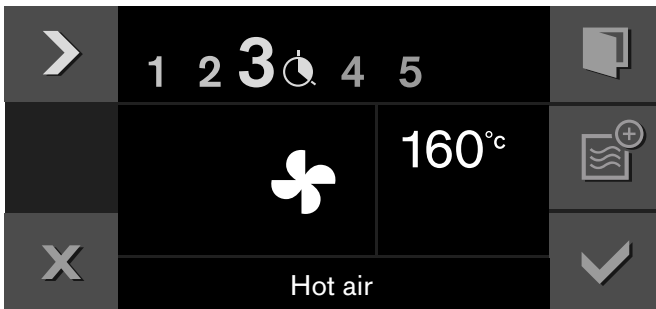

- 8 Use > to select the ⌚ "Cooking time" function.
- 9 Set the required cooking time using the rotary selector.

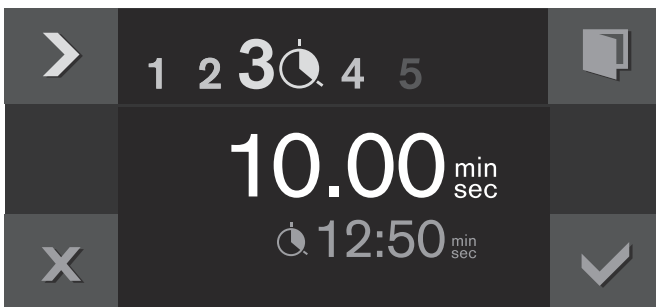

- 10 Press ✓ to confirm. The main menu for the sequential operation is displayed. The settings for each phase are shown in the display.

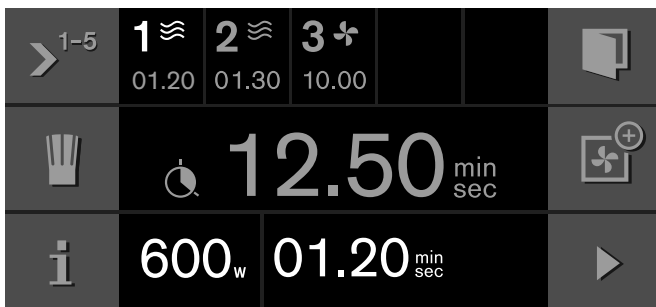

- 11 Press ▶ to start. The operation begins. The cooking time starts counting down.

Once the cooking time has elapsed, the appliance switches off. An audible signal sounds. The signal stops early if you touch the ✓ symbol, open the appliance door, or set the function selector to 0. The sequential operation has finished.

Changing the settings of the current phase:
Touch the || symbol. The operation stops. Touch the >¹⁻⁵ symbol and change the settings. Use the ✓ symbol to exit the menu. Press ▶ to start.

Deleting the settings:

Touch the X symbol.

Pause:

The operation can be paused using the || symbol. Use the ▶ symbol to continue.

Switching off:

To stop the operation and cancel the settings, turn the function selector to 0.

Notes

- The sequential operation can be supplemented with the combination mode.
- The 1000-watt microwave output setting can only be selected once.
- The oven heating functions cannot be combined with the 1000-watt microwave output setting.
- The order of each setting is entirely up to you. You can start with the cooking time, microwave output or oven heating function.
- If you open the appliance door during cooking, the fan may continue to run.

End of cooking time

In oven mode, you can delay the cooking-time end to a later time. This function is not available in conjunction with the microwave oven.

For example: It is 14:00. The dish requires a cooking time of 40 minutes. You want it to be ready at 15:30.

Enter the cooking time and delay the cooking-time end until 15:30. The electronics system calculates the start time. The appliance starts automatically at 14:50 and switches off at 15:30.

Bear in mind that food which spoils easily should not be left in the oven for too long.

Delaying the cooking-time end

You have set the heating function, temperature and cooking time.

- 1 Use > to select the ⌚ "Cooking-time end" function.
- 2 Set the required cooking-time end using the rotary selector.

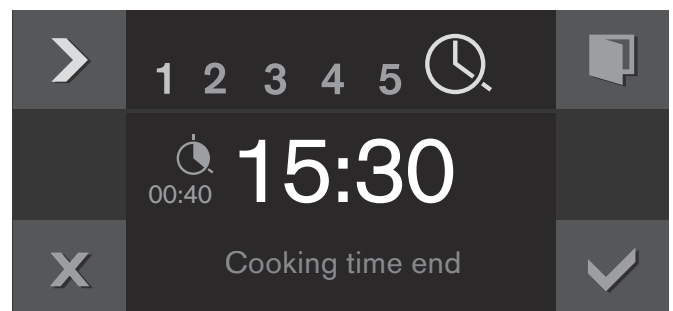

- Press ✓ to confirm.
A message is shown in the display to warn that a cooking-time end has been set. Press ✓ to confirm.
- Press ▶ to start.

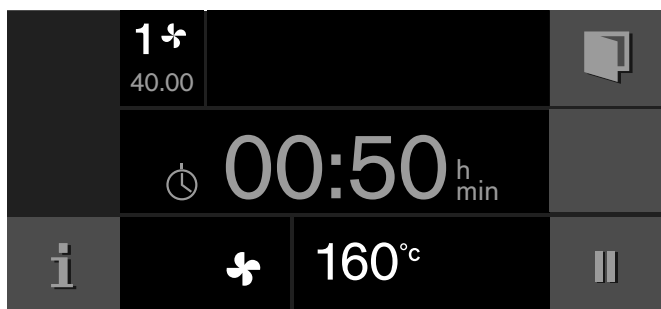

The appliance goes into standby mode. The display shows the operating mode, the temperature, the cooking time and the remaining time until the start. The appliance starts at the calculated time and automatically switches off once the cooking time has elapsed.

Once the cooking time has elapsed, the appliance switches off. An audible signal sounds. The signal stops early if you touch the ✓ symbol, open the appliance door, or set the function selector to 0. The sequential operation has finished.

Changing the cooking time:

Touch the || symbol. Use > to select the ⌚ "Cooking time" function. Set the required cooking time using the rotary selector. Press ✓ to confirm. Press ▶ to start.

Changing the cooking-time end:

Touch the || symbol. Use > to select the ⌚ "Cooking-time end" function. Set the required cooking-time end using the rotary selector. Press ✓ to confirm. Press ▶ to start.

Deleting the settings:

Touch the ✕ symbol.

To cancel the entire procedure:

Set the function selector to 0.

Automatic programmes

The automatic programmes enable you to prepare food very easily. You select the programme and enter the weight of your food. The automatic programme makes the optimum setting. You can select from 15 programmes.

Setting a programme

- Set the function selector to any operation mode.
Note: The function selector must not be moved to ⚙️ or S.
- Touch the 🎩 "Chef's hat" symbol; the automatic programmes are displayed.

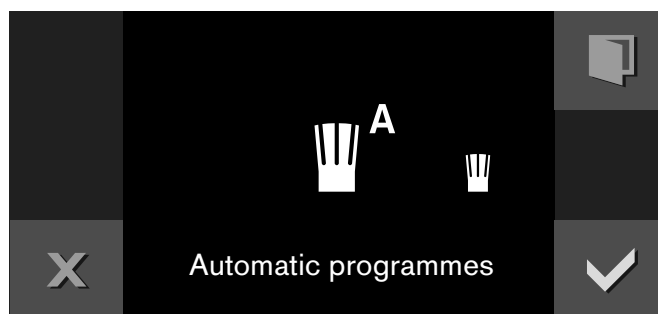

- Press ✓ to confirm.
The first programme appears in the display.
- Use the rotary selector to select the required programme, e.g. Cooking: "Fresh vegetables".

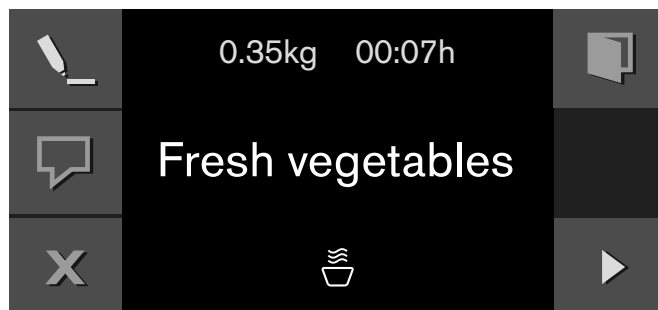



- Touch 📄 to select the 🍲 "Weight" function.
- Turn the rotary selector to set the weight.
- Press ✓ to confirm.
- Press ▶ to start.
The operation begins. The cooking time starts counting down.

An audible signal sounds once the cooking time has elapsed. The signal stops early if you touch the ✓ symbol, open the appliance door, or set the function selector to 0. The programme has finished.



Resting time:

Some dishes require a resting time after the end of the programme in order to reach an even temperature or to simmer. Wait until the resting time has elapsed before removing the food from the appliance.

Tips:

Touch  to view tips on ovenware, accessories and shelf position. Exit this display using the  symbol.

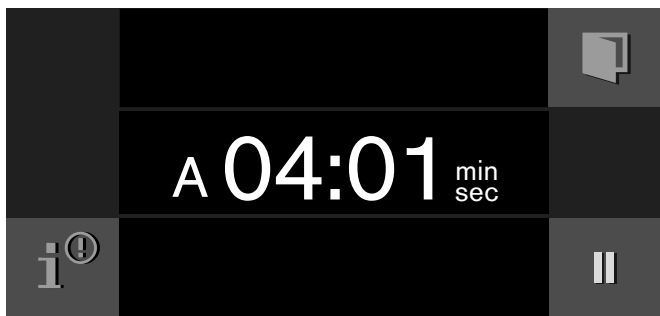

Note:

Use  to view notes on preparation. The  symbol appears for important information and indicates that an action is required. Exit this display using the  symbol.



For some dishes, the display provides instructions for turning or stirring during preparation. Follow the information provided. Opening the appliance door pauses the operation. After closing the appliance door, continue the operation by pressing . If you do not turn or stir the dish, the programme runs as normal until it reaches the end.

Pause:



The operation can be paused using the  symbol. Use the  symbol to continue.

Switching off:



To stop the operation and cancel the settings, turn the function selector to 0.

Individual adjustment

If the cooking result of a programme does not meet your expectations, you can make individual adjustments before the programme starts. Enter the settings as described in steps 1 to 4.

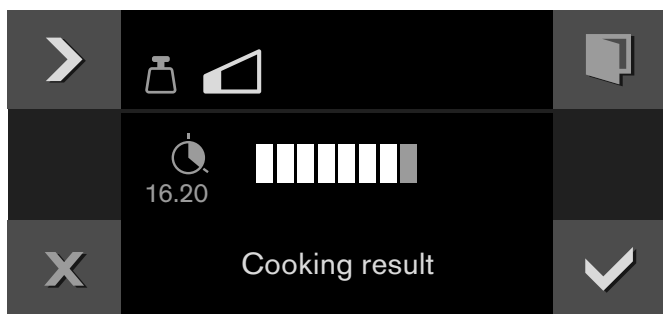
- 1 Use  to select the individual settings.
- 2 Use  to select the  "Cooking result" function.
- 3 Set the cooking result using the rotary selector. Anti-clockwise = cooking result less well done. Clockwise = cooking result more well done.



- 4 Confirm with . The display switches to the programme. The cooking time is changed accordingly.
- 5 Press  to start. Operation starts. The cooking time starts counting down in the display.

Note: This change always applies only to the current programme sequence. When called up the next time, the original automatic programme values will apply.

Instructions for automatic programmes

Place the food in the cold oven.

Take the food out of its packaging and weigh it. If it is not possible to enter the exact weight, you should round it up or down.

When cooking with the automatic programmes, always use microwave-safe, heat-resistant ovenware such as glass or ceramic. Observe the accessories tips in the programme table.

A table of suitable types of food with appropriate weight ranges and the accessories required can be found in the section after the tips.

It is not possible to set a weight outside the weight range.

With many dishes, a signal sounds after a certain time. Turn or stir the food.

Defrosting:

- As far as possible, freeze and store food flat and in portion-sized quantities at -18 °C.
- Place the frozen food on a flat ovenproof dish, e.g. a glass or porcelain plate.
- After defrosting, allow the food to defrost for a further 15 to 90 minutes until it reaches an even temperature.
- Liquid will be produced when defrosting meat or poultry. Drain off this liquid when turning meat and poultry and under no circumstances use it for other purposes or allow it to come into contact with other foods.
- Only defrost bread and bread rolls in the required amounts, as they quickly dry and harden.
- Place frozen bread rolls in the oven. Only fully baked bread rolls are suitable.
- After turning, remove any minced meat that has already defrosted.
- Whole poultry should be placed in the ovenware skin-side down.

Vegetables:

- Fresh vegetables: Cut into pieces of equal size. Add one tablespoon of water for every 100 g of vegetables.
- Frozen vegetables: This programme is only suitable for blanched, not pre-cooked vegetables. It is not suitable for frozen vegetables in cream sauce. Add 1 to 3 tablespoons of water. Do not add water to spinach or red cabbage.

Baked potatoes:

Use potatoes of the same size, washed and dried. Prick the skin.

Rice:

- Do not use brown or boil-in-the-bag rice.
- Add two to two and a half times the amount of water to the rice.

Fish:

Fish fillet, fresh: Add 1 to 3 tablespoons of water or lemon juice.

Leg of lamb:

Place in the ovenware fatty-side down. The leg of lamb should cover two thirds of the ovenware base. Add 50-100 ml of liquid.

Poultry:

- Place the chicken in the dish breast-side down.
- Place chicken pieces in the ovenware skin-side up.

Pizza, frozen:

Use prebaked, frozen pizza with a thin base.

Standing time:

Some dishes need to rest in the oven after the programme has ended.

Dish	Standing time
Vegetables	approx. 5 minutes
Potatoes	approx. 5 minutes. First pour off the remaining water
Rice	5 to 10 minutes
Roast pork, meat loaf	10 minutes

Programme table

	Suitable food	Weight range in kg	Ovenware/accessories, shelf height
Defrost			
Loaf of bread*	Wheat bread, mixed wheat bread, wholemeal bread	0.20 - 1.50	Shallow ovenware without a lid Cooking compartment floor
Bread rolls	Wheat rolls, fully baked	0.05 - 0.60	Wire rack Level 1
Minced meat*	Minced meat, lamb, or pork	0.20 - 1.00	Shallow ovenware without a lid Cooking compartment floor
Whole poultry*	Chicken, duck	0.70 - 2.00	Shallow ovenware without a lid Cooking compartment floor
* Observe the signals given when it is time to turn the food.			
Cooking			
Fresh vegetables*	Cauliflower, broccoli, carrots, kohlrabi, leeks, peppers, courgettes	0.20 - 1.00	Ovenware with lid Cooking compartment floor
Frozen vegetables*	Cauliflower, broccoli, carrots, kohlrabi, red cabbage, spinach	0.15 - 1.00	Ovenware with lid Cooking compartment floor
Baked potatoes	Waxy potatoes, predominantly waxy potatoes or floury potatoes, approx. 6 cm thick	0.20 - 2.00	Ovenware without lid Cooking compartment floor
Rice*	Rice, long grain rice	0.10 - 0.50	Deep ovenware with lid Cooking compartment floor

	Suitable food	Weight range in kg	Ovenware/accessories, shelf height
Fresh fish fillet	Fillet of pike, cod, rosefish, pollock, pike-perch	0.20 - 1.00	Ovenware with lid Cooking compartment floor

* Observe the signals given when it is time to stir the food.

Combi cooking

Frozen pizza	Pizza with thin base, prebaked	0.15 - 0.55	Wire rack Level 3
Frozen lasagne	Lasagne bolognese	0.40 - 1.05	Ovenware without lid Cooking compartment floor
Fresh chicken*	Whole chicken	0.80 - 1.80	Ovenware with lid Cooking compartment floor
Fresh chicken portions	Chicken thigh, half chicken	0.40 - 1.60	Ovenware with lid Cooking compartment floor
Meat loaf	approx. 8 cm thick	0.80 - 1.50	Ovenware without lid Cooking compartment floor
Leg of lamb*	Leg of lamb or shoulder of lamb, boned	0.80 - 2.00	Ovenware without lid Cooking compartment floor





* Observe the signals given when it is time to turn the food.

Individual recipes

You have the option to save up to 50 individual recipes. You can record or program a recipe. You can enter a name for these recipes so that, if required, you can access them again quickly and easily.

Recording a recipe

You have the option to set up to five phases one after the other and to record these.

- 1 Use the function selector to set the required microwave power or oven heating type. The  symbol is displayed.
- 2 Touch the  symbol and use the rotary selector to select "Individual recipes".
- 3 Touch  to confirm.
- 4 Use the rotary selector to select a free memory location.
- 5 Touch the  symbol.
- 6 Use the rotary selector to set the microwave cooking time, temperature or grill setting.

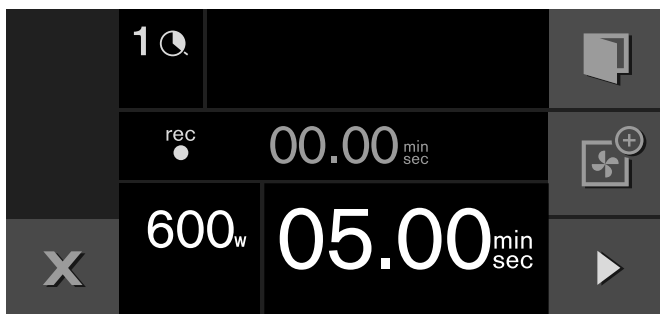

- 7 Touch  to start. The first phase is recorded – in this case, 600 W microwave power setting and microwave cooking time of 5 minutes. You can see the cooking time counting down. After the cooking time has elapsed, you can record another phase.

Note: You can use the  symbol to end the phase prematurely.

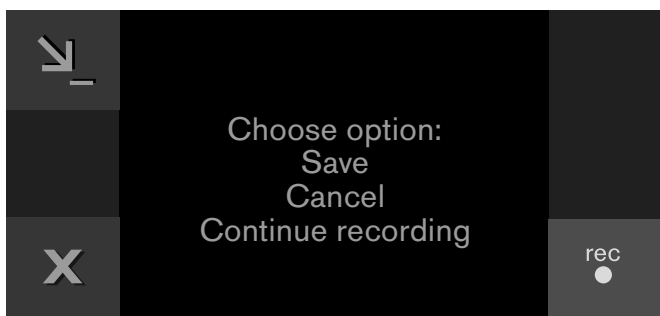



For further actions, three options are available for selection.

Save: Touch the  symbol. The recipe is saved. Enter the name under "ABC" (see the section Entering names).



Cancel: Touch the  symbol. The recipe is not saved.

Further recording: Touch the  symbol. The recording is continued.

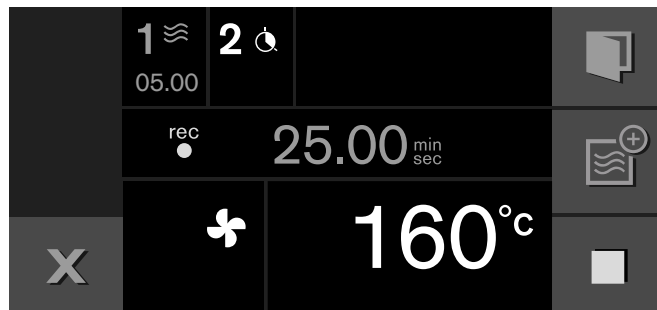
- 8 Further recording: Touch the  symbol.
- 9 Use the function selector to set the required microwave power or oven heating type. Use the rotary selector to set the microwave cooking time, temperature or grill setting. Example: Hot air 160 °C.
- 10 Touch  to start.



Note: Oven heating type: The cooking time is recorded.





- 11 To end this phase, touch the  symbol. This phase is saved, along with the cooking time, which in this case is 20 minutes.
- 12 Further recording: Touch the  symbol.
- or -
If the dish has reached the required cooking result, save the recipe to end the recording.
- 13 **Save:** Touch the  symbol. The recipe is saved. Enter the name under "ABC" (see the section Entering names).

Notes

- If you open the appliance door, the recording of this phase ends.
- Operation is possible in combination mode (see the section Combination mode).

Programming a recipe

You can programme and save up to 5 preparation phases.

- 1 Select the required microwave output or oven heating function using the function selector. The  symbol is displayed.
- 2 Touch the  symbol and select "Individual recipes" with the rotary selector.
- 3 Press  to confirm.
- 4 Select a free memory location by turning the rotary selector.
- 5 Touch the  symbol.
- 6 Enter the name in "ABC" (refer to the Entering names section).
- 7 Touch the  symbol.

- Use the > symbol to select the first phase.
The initial set heating function is displayed. You can change the heating function using the function selector. Operation in combination mode is possible (refer to the Combination mode section).
- Set the microwave cooking time, temperature or grill setting using the rotary selector.

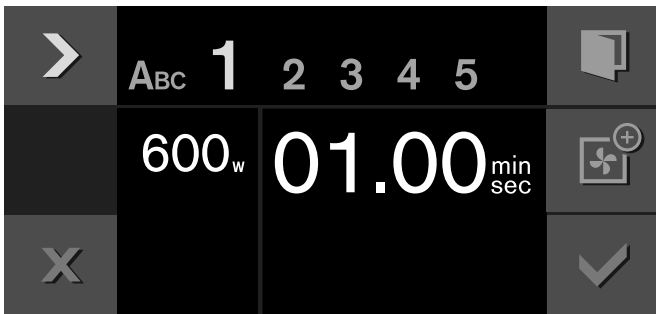

- Use the > symbol to select the next phase.
- or -
If preparation is complete, finish making entries.
- Save with ✓.
- or -
Cancel with X and exit the menu.

Entering names

- Enter the name of the recipe in "ABC".

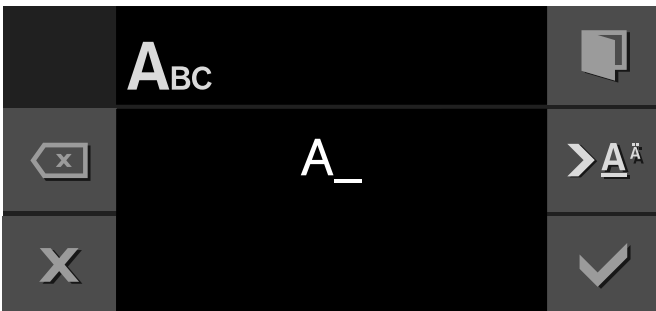

Rotary selector	Select letters A new word always begins with a capital letter.
>A ^ä	Press briefly: moves the cursor right Press and hold: shifts to umlauts and special characters Press twice: adds a line break
>Ä	Press briefly: moves the cursor right Press and hold: shifts to normal characters Press twice: adds a line break
<X	Deletes letters

- Save with ✓.
- or -
Cancel with X and exit the menu .

Note: For entering a name, Latin characters, certain special characters and numbers are available.

Starting recipes

- Set the function selector to the desired type of heating.
The W symbol is displayed.
- Touch the W symbol and select "Individual recipes" using the rotary selector.
- Confirm with ✓.
- Use the rotary selector to select the desired recipe.
- Press ▶ to start.
Operation starts. The cooking time starts counting down in the display.
The settings for each phase are shown in the display.

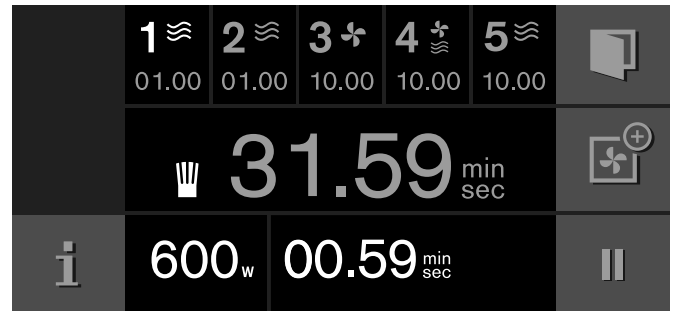





Note: You can set the temperature, grill setting for a type of oven heating and the cooking time for a microwave output using the rotary selector while the recipe is in progress. This does not change the saved recipe.

Change recipe

You can change the settings of a recorded or programmed recipe.

- Turn the function selector to any type of heating.
The W symbol is displayed.
- Touch the W symbol and use the rotary selector to select "Individual recipes".
- Touch ✓ to confirm.
- Use the rotary selector to select the desired recipe.
- Touch the W symbol.
- Use the > symbol to select the required phase.
The settings are displayed. You can use the rotary selector or function selector to change the settings.
- Touch ✓ to save.
- or -
Touch X to cancel and exit the menu.

Deleting recipes

- 1 Set the function selector to a desired type of heating.
The  symbol is displayed.
- 2 Touch the  symbol. Select "Individual recipes" using the rotary selector.
- 3 Confirm with .
- 4 Use the rotary selector to select the desired recipe.
- 5 Delete the recipe with .
- 6 Confirm with .

Timer functions

You use the timer menu to make the following settings:

 Short-term timer

 Stopwatch

Calling up the timer menu

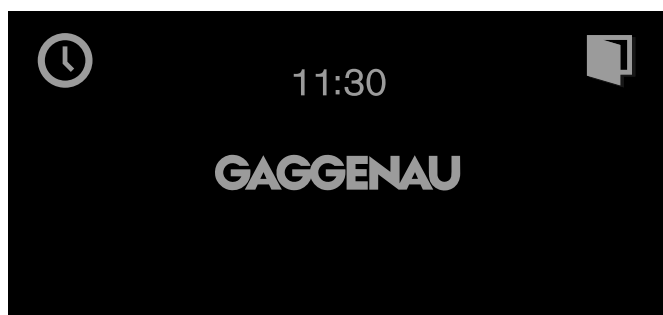

The appliance must be on and the function selector must be at **0** or .

Touch the  symbol.



The "Timer" menu is displayed.

Notes

- If you turn the function selector to a heating function or **S** "Basic settings" while the timer or the stopwatch are running, a message will appear in the display. Confirm the message by pressing the  symbol, and pause the timer or stopwatch. The appliance is ready for operation. To continue operating the timer or stopwatch, turn the function selector back to the zero setting **0** or .
- The timer and the stopwatch can be operated at the same time.

When the function selector is at the zero setting **0**, only the timer is displayed. In the  "Light" setting, the timer and stopwatch are displayed.

Timer

The timer only runs if no other function is set. You can enter a maximum of 90 minutes.

Setting the timer

- 1 Call up timer menu.
The "Timer"  function is displayed.
- 2 Turn the rotary selector to set the required cooking time.

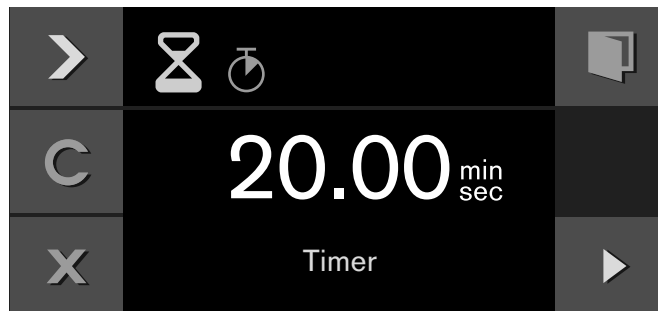

- 3 Start with .



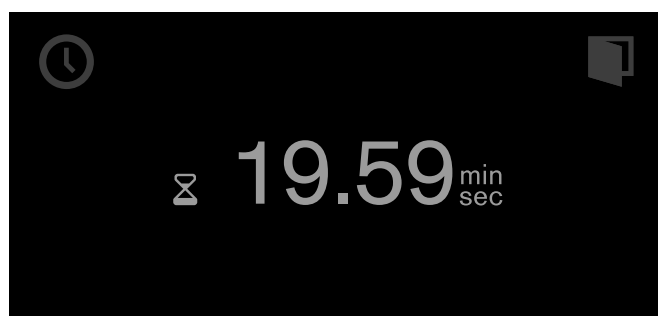

The timer menu closes and the time begins to count down. The  symbol and the countdown appear in the display.





A signal sounds once the time has elapsed. Touch the  symbol to silence.

You can exit the timer menu at any time by touching the **X** symbol. This erases the settings.

To stop the timer:

Call up timer menu. Touch  to select the "Timer"  function and touch the  symbol. To allow the timer to continue counting down, touch the  symbol.

Switching off the timer early:

Call up timer menu. Touch  to select the "Timer"  function and touch the  symbol.

Stopwatch

The stopwatch only runs if no other function is set.

The stopwatch counts from 0 seconds up to 90 minutes.

It also has a pause function, which enables you to temporarily stop the clock.

Starting the stopwatch

- 1 Call up the "Timer" menu.
- 2 Touch **>** to select the **⌚** "Stopwatch" function.

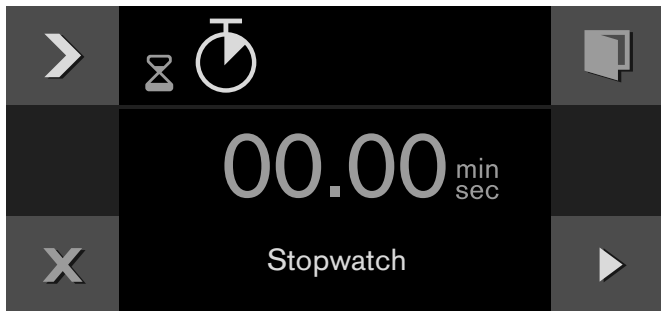

- 3 Press **▶** to start.

The "Timer" menu is closed and the time starts counting down. The **⌚** symbol and the elapsed time are shown in the display.

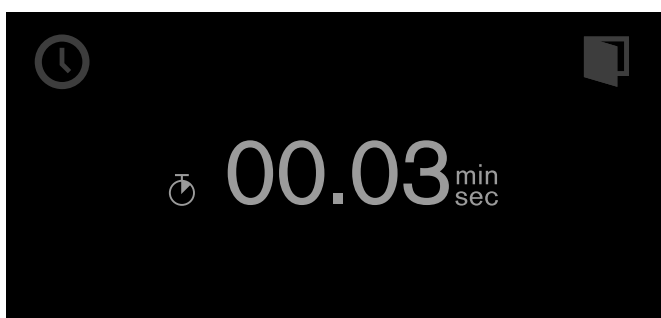

Pausing and restarting the stopwatch

- 1 Call up the "Timer" menu.
- 2 Touch **>** to select the **⌚** "Stopwatch" function.
- 3 Touch the **||** symbol.

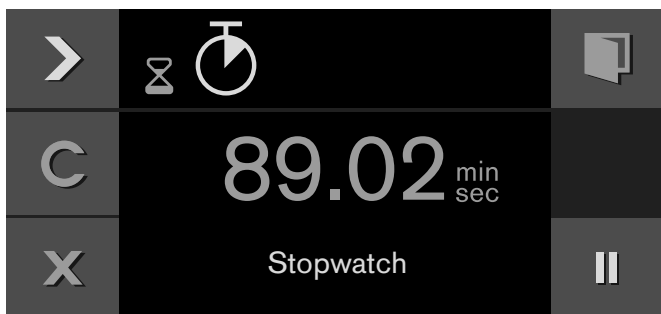

The time stops. The symbol changes to **▶** "Start".

- 4 Press **▶** to start.

The time continues to run. When 90 minutes is reached, the display pulsates and a signal sounds. The signal stops when you touch the **✓** symbol. The **⌚** symbol in the display goes out. The process has finished.

To switch off the stopwatch:

Call up the "Timer" menu. Touch **>** to select the **⌚** "Stopwatch" function and touch the **C** symbol.

Long-term timer

With this function, the appliance maintains a temperature of 85 °C with the "Hot air" heating function.

You can keep food warm for up to 74 hours without having to switch the appliance on or off.

Bear in mind that food which spoils easily should not be left in the oven for too long.

Notes

- You must set the long-term timer to "available" in the basic settings (refer to the Basic settings section).
- The long-term timer cannot be selected if the timer or the stopwatch are activated.

Setting the long-term timer

- 1 Set the function selector to **⌚**.
- 2 Touch the **⌚** symbol.
The default value 24 hrs at 85 °C appears in the display.
- 3 Touch the **⌚** symbol.

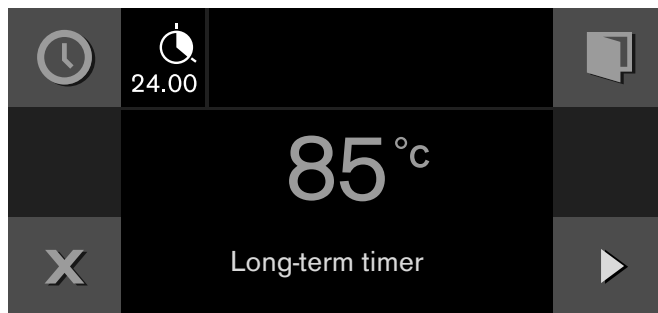

- 4 Set the desired cooking time **⌚** using the rotary selector.
- 5 Confirm with **✓**.
- 6 Press **▶** to start.

The appliance starts. **⌚** and the temperature appear in the display.

The oven and display lighting are switched off. The control panel is locked; no key tone sounds when you touch the touch keys.

Once the set time has elapsed, the appliance stops heating. Turn the function selector to **0**.

Switching off:

To end the process, turn the function selector to **0**.

Child lock

The appliance has a childproof lock to prevent children operating it accidentally.

Notes

- You need to set the childproof lock to "available" in the basic settings (see section entitled 'Basic settings').
- If there is a power cut after the childproof lock has been activated, the childproof lock may be off when the power comes back on again.

Activate the child lock

Prerequisite:

The function selector is set to **0**.

Touch and hold the  symbol for at least 6 seconds.

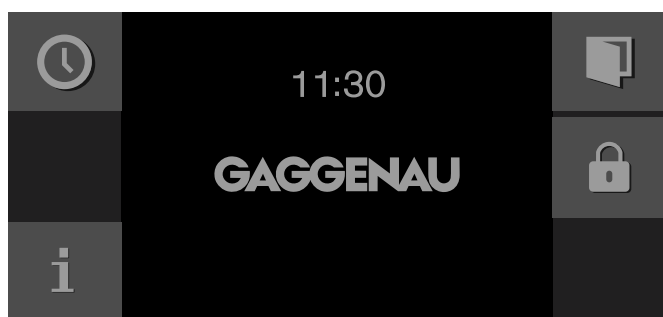

The child lock is activated. The standby screen appears. The  symbol is shown at the top of the display.

Deactivating the child lock

Prerequisite:

The function selector is set to **0**.

Touch and hold the  symbol for at least 6 seconds.

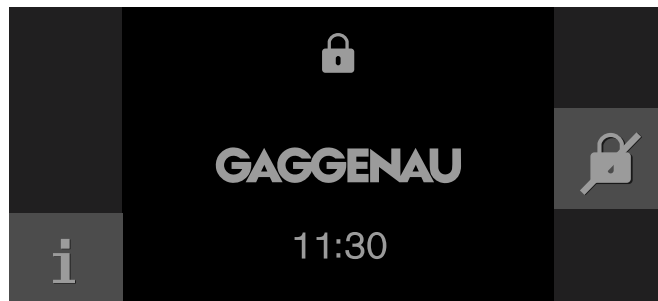



The child lock is deactivated. You can set the appliance as usual.



Basic settings















Your appliance can be individually adjusted in the basic settings.

- 1 Set the function selector to **S**.
You are in the "Basic settings" menu.
- 2 Turn the rotary selector to select the required basic setting.
- 3 Touch the  symbol.

- 4 Set the basic setting using the rotary selector.
- 5 Press  to save or press  to cancel and exit the current basic setting.
- 6 Set the function selector to **0** to exit the basic settings menu.

The changes are saved.

	Basic setting	Permitted settings	Explanation
	Brightness	Level 1, 2, 3, 4, 5*, 6, 7, 8	Sets the display brightness
	Standby screen	On*/Off - Clock - Clock + GAGGENAU logo* - Date - Date + GAGGENAU logo - Clock + date - Clock + date + GAGGENAU logo	Appearance of the standby screen. Off: No display. Use this setting to reduce the standby consumption of your appliance. On: Several displays can be set, confirm "On" with  and use the rotary selector to select the desired display. The selection is displayed.

	Display	Reduced*/Standard	If the 'Reduced' setting has been selected, only the most important information will be shown on the display after a short time.
	Touch field colour	Grey* / White	Selects the colour of the symbols on the touch fields
	Touch field tone	Tone 1* / Tone 2 / Off	Selects an audible signal for when a touch field is touched
	Touch field tone volume	Level 1, 2, 3, 4, 5*, 6, 7, 8	Sets the volume of the touch field tone
	Signal volume	Level 1, 2, 3, 4, 5*, 6, 7, 8	Sets the volume of the audible signal
	Heating-up time/audible signal	Heating up with audible signal* Rapid heat-up with audible signal Heating up without audible signal Rapid heat-up without audible signal	With the heating-up function, the audible signal sounds when the desired temperature is reached. With the "Rapid heat-up" function, the desired temperature is reached particularly quickly.
	Time format	AM/PM / 24 h*	Display the clock in 24 or 12-hour format
	Time	Current time	Setting the clock
	Clock change	Manual* / Automatic	Automatically changes the clock to daylight-savings time. If automatic: Setting the month, day and week for when the time should be changed over. To be set for both summer and winter time.
	Date format	D.M.Y* D/M/Y M/D/Y	Sets the date format
	Date	Current date	Sets the date. You can switch between year/month/day using the symbol ➤.
	Temperature format	°C* / °F	Sets the temperature unit
	Language	German* / French / Italian / Spanish / Portuguese / Dutch / Danish / Swedish / Norwegian / Finnish / Greek / Turkish / Russian / Polish / Czech / Slovenian / Slovakian / Arabic / Hebrew / Japanese / Korean / Thai / Chinese / English US / English	Select language for text display Note: If the language is changed, the system restarts. This takes a few seconds. The basic settings menu is also closed.
	Factory settings	Restore appliance to factory settings	Confirm the question "Delete all individual settings made and reset to factory settings?" by pressing ✓ or cancel by pressing ✕. Note: Individual recipes will also be deleted if the appliance is restored to factory settings. After restoring factory settings, the "Initial settings" menu is displayed.



Demo mode

On / Off*

Only for presentation purposes. The appliance does not heat up in demo mode, all other functions are available.

The "Off" setting must be activated for normal operation. The setting is only possible in the first 3 minutes after connecting the appliance to the mains.



Long-term timer

Not available*/Available

Available: The long-term timer can be set; see section entitled 'Long-term timer'.



Childproof lock

Not available*/Available

Available: The childproof lock can be activated (see section entitled 'Childproof lock').

* Factory setting

Cleaning

With thorough care and cleaning your appliance will retain its looks and remain in good order. We will explain here how you should care for and clean your appliance correctly.

Note: Unpleasant odours, e.g. after fish has been prepared, can be removed very easily. Add a few drops of lemon juice to a cup of water. Always place a glass rod/spoon into the container to prevent delayed boiling. Heat the water for 1 to 2 minutes at maximum microwave output.

⚠ Risk of burns!

The appliance becomes very hot. Never touch the interior surfaces of the cooking compartment or the heating elements. Always allow the appliance to cool down. Keep children at a safe distance.

⚠ Risk of electric shock!

Do not use any high-pressure cleaners or steam cleaners, which can result in an electric shock.

⚠ Risk of injury!

Scratched glass in the appliance door may develop into a crack. Do not use a glass scraper, sharp or abrasive cleaning aids or detergents.

Self-cleaning surface in the cooking compartment

The back wall of the oven is coated with self-cleaning enamel. It cleans itself while the oven is in operation. Sometimes, larger splashes of food may not disappear until the oven has been operated several times. Residue left by spices and similar ingredients can be removed with a dry cloth or a soft brush.

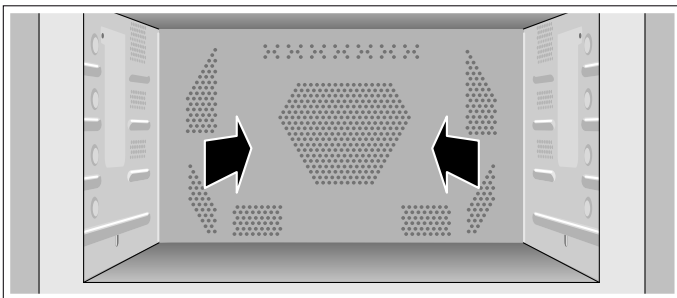

Notes

- Never treat the self-cleaning surface with oven cleaner. If oven cleaner is accidentally applied to the interior back wall, remove it immediately with a sponge and plenty of water.
- Never use abrasive cleaning agents. You will scratch or destroy the highly porous coating.
- Never clean the self-cleaning surface with a scouring pad.

- Light discolouration of the enamel does not affect self-cleaning.

Cleaning the cooking compartment floor, ceiling and side walls: Use a dishcloth and hot detergent solution or a vinegar solution.

Cleaning agents

To ensure that the different surfaces are not damaged by using the wrong cleaning agent, observe the information in the table.

Do not use

- sharp or abrasive cleaning agents.
- metal or glass scrapers to clean the glass in the appliance door.
- metal or glass scrapers to clean the door seal.
- hard scouring pads or cleaning sponges.

Wash new sponge cloths thoroughly before use.

Area	Cleaning agents
Appliance front	Hot detergent solution: Clean using a dishcloth and then dry with a soft cloth. Do not use a metal or glass scraper for cleaning.
Display	Wipe down using a microfibre cloth or a slightly damp cloth. Do not wipe with a wet cloth.
Stainless steel	Hot detergent solution: Clean using a dishcloth and then dry with a soft cloth. Remove traces of limescale, grease, starch and albumin (e.g. egg white) immediately. Corrosion can form under such residues. Special stainless steel cleaning agents can be obtained from the after-sales service or from specialist retailers.
Aluminium	Clean with a mild window cleaning agent. Using a window cloth or a non-fluffing microfibre cloth, wipe over the surfaces lightly in a horizontal direction.
Cooking compartment (self-cleaning back wall)	Do not use oven cleaner! Remove residue with dry cloth or soft brush. Refer to section "Self-cleaning surface in the cooking compartment".
Cooking compartment (excluding stainless steel)	Hot detergent solution or vinegar solution: Clean using a dishcloth and then dry with a soft cloth. If oven is very dirty: Use oven cleaner, but only when oven is cold.
Cooking compartment made of stainless steel	Do not use oven spray or other aggressive oven cleaners or abrasive materials. Scouring pads, rough sponges and pan cleaners are also unsuitable. These items scratch the surface. Allow the interior surfaces to dry thoroughly.

Area	Cleaning agents
Very dirty cooking compartment made of stainless steel or enamel	Oven cleaner gel (order number 463582 from the after-sales service or from online shop). Please note: <ul style="list-style-type: none"> ● Must not come into contact with seals on the door and light. ● Maximum application time is 12 hours. ● Do not use on warm surfaces. ● Always rinse using water! ● Observe the instructions on the packaging.
Glass cover for the cooking compartment light	Hot detergent solution: Clean with a dishcloth.
Door panels	Glass cleaner: Clean with a dishcloth. Do not use a glass scraper.

Area	Cleaning agents
Door seal Do not remove	Hot detergent solution: Clean with a dishcloth, do not scrub. Do not use a metal or glass scraper for cleaning.
Accessories	Hot detergent solution: Soak and then clean with a dishcloth or a brush.

Cleaning the glass cover

The glass cover for the oven light is located on the left side wall inside the oven. Undo the screw from the cover. Then you can clean the glass with detergent solution.

Risk of burns!



The glass cover for the oven light becomes hot. Always wear heat-resistant gloves when handling the glass cover.

Trouble shooting

Malfunctions often have simple explanations. Please read the following notes before calling the after-sales service.

Risk of electric shock!

Incorrect repairs are dangerous. Repairs may only be carried out by one of our trained after-sales engineers. If the appliance is faulty, unplug the mains plug or switch off the fuse in the fuse box. Contact the after-sales service.

Disruption	Possible cause	Solution
Appliance not working, no display	Plug not inserted	Connect the appliance to the electricity mains
	Power failure	Check whether other kitchen appliances are working
	Fuse defective	Check in the fuse box whether the fuse for the appliance is in working order
	Operating error	Switch off the fuse for the appliance in the fuse box and switch it on again after about 60 seconds
Appliance cannot be started	Appliance door is not quite closed	Close appliance door
The food takes longer than usual to heat up	The microwave output setting is too low	Select a higher power setting
	A larger amount than usual has been placed in the appliance	Double the amount = almost double the time
	The food was colder than usual	Stir or turn the food during cooking
The appliance is not working and the display does not respond.  appears on the display	Childproof lock activated	Deactivate the childproof lock (see section entitled 'Childproof lock')
Appliance does not heat up,  appears in the display	Appliance is in demo mode	Deactivate the demo mode in the basic settings

Power cut

Your appliance can bridge a power cut of a few seconds. Operation continues.

If the power cut was for a longer period and the appliance was in operation, a message appears in the display. Operation is interrupted.

Set the function selector to **0**, then the appliance can be operated again as usual.

Demo mode

The  symbol appears on the display when the appliance is in demo mode. The appliance will not heat up.

Briefly disconnect the appliance from the mains (switch off the household fuse or the circuit breaker in the fuse box). Then deactivate demo mode in the basic settings within 3 minutes (see section entitled 'Basic settings').

Replacing the oven light bulb

It is possible to replace the oven light. Heat-resistant 60 W, 240 V halogen bulbs can be obtained from the after-sales service or from a specialist retailer.

Risk of electric shock!

When replacing the cooking compartment bulb, the bulb socket contacts are live. Before replacing the bulb, unplug the appliance from the mains or switch off the circuit breaker in the fuse box.

Note: Always remove the new halogen bulb from the packaging using a dry cloth. This increases the service life of the bulb.

Method

Note: You must remove the whole appliance in order to replace the cooking compartment light. Follow the installation instructions.

- 1 Unplug the appliance from the mains or switch off the circuit breaker in the fuse box.
- 2 Open the appliance door.
Undo the securing screws on the right and left-hand side of the oven. Follow the installation instructions.
- 3 Carefully lift out the appliance.

- 4 Undo the screw from the light cover on the outer left-hand side wall and remove the cover. (Fig. A)
Pull out the halogen light. (Fig. B).

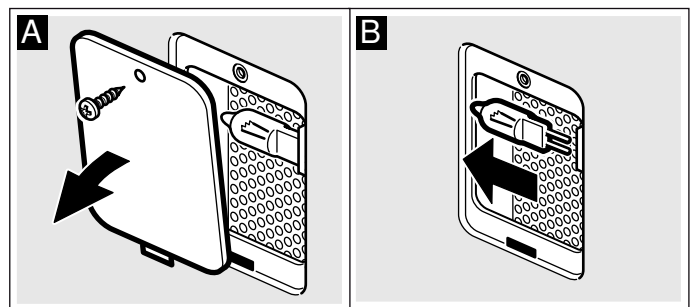
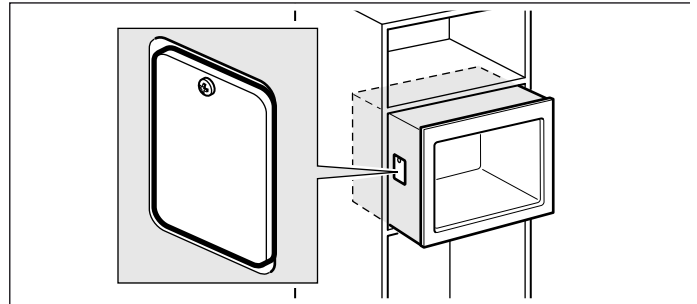

- 5 Insert the new halogen bulb (Fig. C)

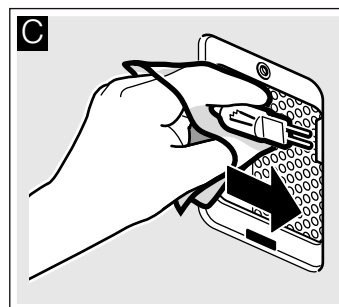

- 6 Screw the lamp cover in place.
Reassemble the appliance in the reverse order.
- 7 Switch the circuit breaker in the fuse box back on or plug in the mains plug.

Replacing the glass cover

If the glass cover in the oven is damaged, it must be replaced. You can obtain covers from the after-sales service. Please supply your appliance's E number and FD number.

Technical data

Power supply	220-240 V, 50/60 Hz
Maximum total connected load	3100 W
Microwave output setting	1000 W (IEC 60705)
Max. grill output power	2000 W
Hot air output power	1950 W
Microwave frequency	2450 MHz
Fuse	16 A

Dimensions (H/W/D)

- appliance	455 x 590/752 x 582 mm
- cooking compartment	236 x 445 x 348 mm

VDE approved	yes
CE mark	yes

This appliance corresponds to the standards EN 55011 and CISPR 11. It is a Group 2, Class B product.

Group 2 means that microwaves are produced for the purpose of heating food. Class B states that the appliance is suitable for private households.

After-sales service

Our after-sales service is there for you if your appliance needs to be repaired. We will always find an appropriate solution, also in order to avoid after-sales personnel having to make unnecessary visits.

E number and FD number

When calling us, please give the full product number (E no.) and the production number (FD no.) so that we can provide you with the correct advice. The rating plate bearing these numbers can be found when you open the appliance door.

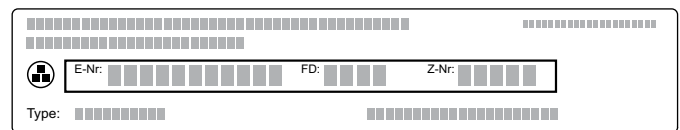

To save time, you can make a note of the number of your appliance and the telephone number of the after-sales service in the space below, should it be required.

E no.

FD no.

After-sales service ☎

Please note that a visit from an after-sales service engineer is not free of charge, even during the warranty period.

Please find the contact data of all countries in the enclosed customer service list.

To book an engineer visit and product advice

GB 0344 892 8988
Calls charged at local or mobile rate.

IE 01450 2655
0.03 € per minute at peak.
Off peak 0.0088 € per minute.

AU 1300 368 339

NZ 09 477 0492

Trust the expertise of the manufacturer, and rest assured that the repair will be carried out by trained service technicians using original spare parts for your domestic appliance.

Settings table and tips

Here you will find a selection of recipes and the ideal settings for them. We will show you which type of heating and which temperature or microwave output setting is best for your meal. You can find information about suitable accessories and the height at which they should be inserted. There are also tips about ovenware and preparation methods.

Notes

- The values in the table always apply to food placed into the cooking compartment when it is cold and empty. Only preheat the appliance if the table specifies that you should do so. Before using the appliance, remove all accessories from the cooking compartment that you will not be using.
- Do not line the accessories with greaseproof paper until after they have been preheated.
- The times specified in the tables are only guidelines. They will depend on the quality and composition of the food.
- Use the accessories supplied. Additional accessories may be obtained from specialist retailers or from the after-sales service.
- Always use an oven cloth or oven gloves when taking accessories or ovenware out of the cooking compartment.

Risk of scalding!

Hot liquid may spill over when pulling the glass tray out. Pull the glass tray carefully out of the cooking compartment.

The following tables provide you with numerous options and settings for the microwave.

The times specified in the tables are only guidelines. They may vary according to the ovenware used, the quality, temperature and consistency of the food.

Time ranges are often specified in the tables. Set the shortest time first and then extend the time if necessary.

It may be that you have different quantities from those specified in the tables. A rule of thumb can be applied for microwave-only operation: Double the amount - just under double the cooking time, half the amount - half the cooking time.

You can place the ovenware in the centre of the wire rack or on the cooking compartment floor. The food will then absorb the microwaves from all sides.

Defrosting

Place the frozen food in an open container on the oven floor.

Delicate parts such as the legs and wings of chicken or fatty outer layers of roasts can be covered with small pieces of aluminium foil. The foil must not touch the appliance walls. You can remove the foil half way through the defrosting time.

Turn or stir the food once or twice during the defrosting time. Large pieces of food should be turned several times. When turning, remove any liquid that has been produced during defrosting.

Leave defrosted items to stand at room temperature for a further 10 to 60 minutes so that the temperature can stabilise. The giblets can be removed from poultry at this point.

Note: Place the ovenware on the cooking compartment floor.

Dish	Quantity	Microwave output setting in watts, cooking time in minutes	Notes
Meat, whole pieces of beef, pork, veal (on the bone or boned)	800 g	180 W, 15 mins + 90 W, 15- 25 mins	Turn several times.
	1000 g	180 W, 15 mins + 90 W, 25- 35 mins	
	1500 g	180 W, 20 mins + 90 W, 25- 35 mins	
Meat in pieces or slices of beef, pork, veal	200 g	180 W, 5 mins + 90 W, 4- 6 mins	Separate any pieces of meat when turning
	500 g	180 W, 10 mins + 90 W, 5- 10 mins	
	800 g	180 W, 10 mins + 90 W, 10- 15 mins	
Minced meat, mixed	200 g	90 W, 15 mins	Freeze food flat if possible. Turn several times during defrosting and remove any meat that has already defrosted.
	500 g	180 W, 5 mins + 90 W, 10- 15 mins	
	800 g	180 W, 10 mins + 90 W, 15- 20 mins	
Poultry and poultry pieces	600 g	180 W, 5 mins + 90 W, 10- 15 mins	Turn during defrosting. Remove any excess liquid.
	1200 g	180 W, 10 mins + 90 W, 20- 25 mins	
Duck	2000 g	180 W, 20 mins + 90 W, 30- 40 mins	Turn several times. Remove any excess liquid.

Dish	Quantity	Microwave output setting in watts, cooking time in minutes	Notes
Goose	4500 g	180 W, 30 mins + 90 W, 60- 80 mins	Turn every 20 minutes. Remove any excess liquid.
Fish Fillet, fish steak, slices	400 g	180 W, 5 mins + 90 W, 10- 15 mins	Separate any defrosted parts.
Whole fish	300 g	180 W, 3 mins + 90 W, 10- 15 mins	Turn during defrosting.
	600 g	180 W, 8 mins + 90 W, 15- 25 mins	
Vegetables, e.g. peas	300 g	180 W, 10-15 mins	Stir carefully during defrosting.
	600 g	180 W, 10 mins + 90 W, 8- 13 mins	
Fruit, e.g. raspberries	300 g	180 W, 7-10 mins	Stir carefully during defrosting and separate any defrosted parts.
	500 g	180 W, 8 mins + 90 W, 5-10 mins	
Butter, defrosting	125 g	90 W, 6-8 mins	Remove all packaging.
	250 g	180 W, 2 mins + 90 W, 3- 5 mins	
Bread, whole loaf	500 g	180 W, 3 mins + 90 W, 10-15 mins	Turn during defrosting.
	1000 g	180 W, 5 mins + 90 W, 15-25 mins	
Cakes, dry, e.g. sponge cake	500 g	90 W, 10-15 mins	Separate the pieces of cake. Only for cakes without icing, cream or crème pâtissière.
	750 g	180 W, 3 mins + 90 W, 10-15 mins	
Cakes, moist, e.g. fruit flan, cheesecake	500 g	180 W, 5 mins + 90 W, 15-25 mins	Only for cakes without icing, cream or gelatine.
	750 g	180 W, 7 mins + 90 W, 15-25 mins	

Defrosting and heating up or cooking frozen food

Take ready meals out of the packaging. They will heat up more quickly and evenly in microwaveable ovenware. The different components of the meal may not require the same amount of time to heat up .

Food which lies flat will cook more quickly than food which is piled high. You should therefore distribute the food so that it is as flat as possible in the container. Different foodstuffs should not be vertically stacked in layers.

Always cover the food. If you do not have a suitable cover for your container, use a plate or special microwave foil.

Stir or turn the food 2 - 3 times during cooking.

After heating, allow the food to stand for a further 2 to 5 minutes so that it can achieve an even temperature.

This will help the food retain its own distinct taste, so it will require less seasoning.

Note: Place the ovenware on the cooking compartment floor.

Dish	Quantity	Microwave output setting in watts, cooking time in minutes	Notes
Full meal, one-course meal, ready meal (2-3 items)	300-400 g	600 W, 11-15 mins	Covered
Soups	400-500 g	600 W, 8-13 mins	Ovenware with lid
Stews	500 g	600 W, 10-15 mins	Ovenware with lid
	1000 g	600 W, 20-25 mins	
Slices or pieces of meat in sauce, e.g. goulash	500 g	600 W, 12-17 mins	Ovenware with lid
	1000 g	600 W, 25-30 mins	
Fish, e.g. fillet steaks	400 g	600 W, 10-15 mins	Covered
	800 g	600 W, 20-25 mins	
Side dishes, e.g. rice, pasta	250 g	600 W, 2-5 mins	Ovenware with lid; add liquid
	500 g	600 W, 8-10 mins	
Vegetables, e.g. peas, broccoli, carrots	300 g	600 W, 8-10 mins	Ovenware with lid, add 1 tbsp of water
	600 g	600 W, 14-17 mins	
Creamed spinach	450 g	600 W, 11-16 mins	Cook without additional water

Heating food

Risk of scalding!

There is a possibility of delayed boiling when a liquid is heated. This means that the liquid reaches boiling temperature without the usual steam bubbles rising to the surface. Even if the container only vibrates a little, the hot liquid may suddenly boil over and spatter. When heating liquids, always place a glass rod/spoon in the container. This will prevent delayed boiling.

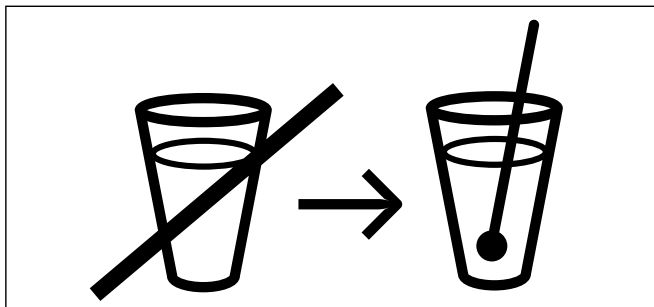

Caution!

Metal - e.g. a spoon in a glass - must be kept at least 2 cm from the oven walls and the inside of the door. Sparks could irreparably damage the glass on the inside of the door.

Notes

- Take ready meals out of the packaging. They will heat up more quickly and evenly in microwaveable ovenware. The different components of the meal may not require the same amount of time to heat up.
- Always cover the food. If you do not have a suitable cover for your container, use a plate or special microwave foil.
- Stir or turn the food several times during cooking. Check the temperature.
- After heating, allow the food to stand for a further 2 to 5 minutes so that it can achieve an even temperature.
- Always use an oven cloth or oven gloves when removing plates from the oven.

Note: Place the ovenware on the cooking compartment floor.

Heating food	Weight	Microwave output setting in watts, cooking time in minutes	Notes
Menu, plated meal, ready meal (2-3 components)	350-500 g	600 W, 4-8 mins	Covered
Drinks	150 ml	1000 W, 1-2 mins	Always place a glass rod/spoon/in the container. Do not overheat alcoholic drinks; check during heating.
	300 ml	1000 W, 2-3 mins	
	500 ml	1000 W, 4-5 mins	
Baby food, e.g. baby bottle	50 ml	360 W, ½-1 min	No teats or lids. Always shake well after heating. You must check the temperature
	100 ml	360 W, ½-1½ mins	
	200 ml	360 W, 1-2 mins	
Soup, 1 cup	175 g each	600 W, 2-3 mins	-
Soup, 2 cups	175 g each	600 W, 3-4 mins	-
Soup, 4 cups	175 g each	600 W, 6-8 mins	-
Meat or pieces of meat in sauce	500 g	600 W, 8-11 mins	Covered
Stew	400 g	600 W, 6-8 mins	Ovenware with lid
	800 g	600 W, 8-11 mins	
Vegetables, 1 portion	150 g	600 W, 2-3 mins	Add a little liquid
Vegetables, 2 portions	300 g	600 W, 3-5 mins	

Cooking food

Food which lies flat will cook more quickly than food which is piled high. You should therefore distribute the food so that it is as flat as possible in the container. Foodstuffs should not be placed in layers on top of one another.

Cook the food in ovenware with a lid. Food should be stirred or turned during cooking.

This will help the food retain more of its own distinct taste, so it will require less seasoning.

After heating, allow the food to stand for a further 2 to 5 minutes so that it can achieve an even temperature.

Note: Place the ovenware on the cooking compartment floor.

Dish	Quantity	Microwave output setting in watts, cooking time in minutes	Notes
Whole chicken, fresh, no giblets	1200 g	600 W, 25-30 mins	Turn halfway through the cooking time.
Fish fillet, fresh	400 g	600 W, 7-12 mins	
Fresh vegetables	250 g	600 W, 6-10 mins	Cut vegetables into pieces of equal size. Add 1-2 tbsp water per 100 g of vegetables, and stir.
	500 g	600 W, 10-15 mins	
Side dishes, Potatoes	250 g	600 W, 8-10 mins	Cut the potatoes into pieces of equal size. Add 1 tbsp water for every 100 g, and stir.
	500 g	600 W, 12-15 mins	
	750 g	600 W, 15-22 mins	
Rice	125 g	600 W, 4-6 mins + 180 W, 12-15 mins	Add double the quantity of liquid.
	250 g	600 W, 6-8 mins + 180 W, 15-18 mins	
Sweet foods, e.g. blancmange (instant)	500 ml	600 W, 6-8 mins	Stir the pudding thoroughly 2 to 3 times during cooking using an egg whisk.
Fruit, compote	500 g	600 W, 9-12 mins	Stir during cooking.

Microwave tips

You cannot find any information about the settings for the quantity of food you have prepared.	Increase or reduce the cooking times using the following rule of thumb: Double amount = double the cooking time, half amount = half the cooking time
The food has become too dry.	Next time, set a shorter cooking time or select a lower microwave output setting. Cover the food and add more liquid.
When the time has elapsed, the food is still not defrosted, hot or cooked.	Set a longer time. Large quantities and food which is piled high require longer times.
When the time has elapsed, the food is overheated at the edge but not done in the middle.	Stir it during the cooking time and next time, select a lower microwave output setting and a longer cooking time.
After defrosting, the poultry or meat is defrosted on the outside but not defrosted in the middle.	Next time, select a lower microwave output setting. If you are defrosting a large quantity, turn it several times.

Cakes and pastries

Always place the cake tin in the centre of the wire rack.

Baking tins: It is best to use dark-coloured metal baking tins.

When using the microwave, use baking containers made of glass, ceramic or plastic. These must be heat-resistant up to 250 °C. Cakes will not brown so well if you use these types of baking containers.

Tables: The times given apply to food placed in a cold oven.

The temperature and baking time depend on the consistency and amount of the mixture. This is why temperature ranges are given in the tables. Begin with the lowest temperature and, if necessary, use a higher setting the next time. A lower temperature results in more even browning.

More information can be found in the "Baking tips" section which follows the tables.

Cake	Ovenware	Level	Type of heating	Temperature °C	Cooking time in minutes
Sponge cake, simple	Ring cake tin/Ring tin/cake tin	1	✚	160-170	60-80
Sponge cake, delicate, e.g. sandcake		1		150-160	60-70
Sponge flan base with crust made from shortcrust pastry	Springform cake tin	1	✚	160-170	35-45
Sponge flan base	Flan tin	1	✚	160-170	35-45
Sponge flan (hot water sponge cake)	Springform cake tin	1	✚	170-180	45-50
Cake with dry topping (sponge)	Glass tray	2	✚	160-170	35-50
Cake with moist topping, e.g. yeast dough with apple crumble	Glass tray	2	✚	155-165	55-65
Plaited loaf with 500 g flour	Glass tray	2	✚	160-170	30-40
Stollen with 500 g flour	Glass tray	2	✚	170-180	60-70
Pizza	Glass tray	2	✚	200-210	30-40
Yeast bread 1 kg**	Glass tray	2	✚	180-190	50-60

* Allow cake to cool in the oven for approx. 20 minutes.

** Never pour water directly into a hot oven.

Cake	Ovenware	Level	Microwave output setting in watts	Cooking time in minutes	Type of heating	Temperature °C
Nut cake	Springform cake tin	1	90 W	30-35	✚	170-180
Fruit tart or cheesecake with shortcrust pastry*	Springform cake tin	2	360 W	40-50	✚	150-160
Fruit pie, delicate with sponge	Ring cake tin or springform cake tin	1	90 W	30-45	✚	170-190
Savoury cakes, e.g. quiche/onion tart	Springform cake tin or quiche tin	2	90 W	50-70	✚	160-180

* Allow cake to cool in the oven for approx. 20 minutes.

Small baked items	Ovenware	Level	Type of heating	Temperature °C	Cooking time in minutes
Biscuits	Glass tray	2	✚	150-170	20-35
Meringue	Glass tray	2	✚	110	90-120
Macaroons	Glass tray	2	✚	110	35-45
Puff pastry	Glass tray	2	✚	180-200	35-45
Bread rolls, e.g. rye bread rolls	Glass tray	2	✚	180-200	25-45

Baking tips

You want to bake according to your own recipe.

Use similar items in the baking tables as a guide.

How to establish whether sponge cake is baked through.

Approximately 10 minutes before the end of the baking time specified in the recipe, pierce the cake with a cocktail stick at its highest point. If the cocktail stick comes out clean, the cake is ready.

The cake collapses.

Use less fluid next time or set the oven temperature 10 degrees lower. Observe the specified mixing times in the recipe.

The cake has risen in the middle but is lower around the edge.	Only grease the base of the springform cake tin. After baking, loosen the cake carefully with a knife.
The cake is too dark.	Select a lower temperature and bake the cake for a little longer.
The cake is too dry.	When it is done, make small holes in the cake using a toothpick. Then drizzle fruit juice or an alcoholic beverage over it. Next time, set the temperature 10 degrees higher and reduce the baking time.
The bread or cake (e.g. cheesecake) looks good, but is soggy on the inside (sticky, streaked with water).	Use slightly less fluid next time and bake for slightly longer at a lower temperature. When baking cakes with a moist topping, bake the base first, cover with almonds or bread crumbs and then add the topping. Please follow the recipe and follow the baking times.
The cake cannot be turned out of the dish when it is turned upside down.	After baking, allow the cake to cool for a further 5 to 10 minutes, then it will be easier to turn out of the tin. If it still sticks, carefully ease it away from the edge of the cake tin using a knife. Turn the cake tin upside down again and cover it several times with a cold, wet cloth. Next time, grease the tin well and sprinkle some bread crumbs into it.
You have measured the temperature of the oven using your own meat thermometer and found there is a discrepancy.	The oven temperature is measured by the manufacturer after a specified period of time using a test rack in the centre of the oven. Ovenware and accessories affect the temperature measurement, so there will always be some discrepancy when you measure the temperature yourself.
Sparks are generated between the tin and the wire rack.	Check that the tin is clean on the outside. Move the tin to a different position in the oven. If this does not help, continue baking without the microwave function or use the glass tray as a surface to place items on. The baking time will then be longer.

Roasting and grilling

Tables: The times given apply to food placed in a cold oven.

The temperature and roasting time depend on the type and amount of food being cooked. This is why temperature ranges are given in the tables. Begin with the lowest temperature and, if necessary, use a higher setting the next time.

For more information, see the section entitled "Tips for grilling and roasting" which follows the tables.

Ovenware: You may use any heat-resistant ovenware which is suitable for use in a microwave. Metal roasting dishes are only suitable for roasting without the microwave function.

The ovenware can become very hot. Use oven gloves to take the ovenware out of the oven.

Place hot glass ovenware on a dry kitchen towel after removal from the oven. The glass could crack if placed on a cold or wet surface.

Tips for roasting: Use a deep roasting dish for roasting meat and poultry.

Check that your ovenware fits in the cooking compartment. It should not be too big.

Meat: Cover the base of the ovenware with a little liquid. Add slightly more liquid for pot roasts. Turn pieces of meat halfway through the cooking time. When the roast is ready, turn off the oven and allow it to rest in the oven for an additional 10 minutes. This allows better distribution of the meat juices.

Tips for grilling: Always keep the oven door closed when grilling and do not preheat.

As far as possible, the pieces of food you are grilling should be of equal thickness. Steaks should be at least 2 to 3 cm thick. This will allow them to brown evenly and remain succulent and juicy. Do not add salt to steaks until they have been grilled.













Use grill tongs to turn the pieces of food you are grilling. If you pierce the meat with a fork, the juices will run out and the meat will become dry.

Dark meat, e.g. beef, browns more quickly than lighter-coloured meat such as veal or pork. When grilling light-coloured meat or fish, these often only brown slightly on the surface, although they are cooked and juicy on the inside.







The grill element switches off and on again automatically. This is normal. The grill setting determines how frequently this will happen.

Tips for braising: Use ovenware with a lid for braising fish.

Add two to three tablespoons of liquid and a little lemon juice or vinegar to the ovenware.

Dish	Quantity	Microwave output setting in watts, cooking time in minutes	Level	Type of heating	Temperature in °C, grill setting	Notes
Pot-roasted beef	approx. 1000 g	180 W, 80-90 mins	0		160-170	Ovenware with lid.
Sirloin, medium rare	approx. 1000 g	180 W, 30-40 mins	0		180-200	Ovenware without lid. Turn halfway through the cooking time.
Boned pork without rind, e.g. neck	approx. 750 g	360 W, 35-45 mins	0		170-180	Ovenware without lid.
Boned pork with crackling*, e.g. shoulder	approx. 1000 g	180 W, 80-90 mins	0		170-180	Ovenware without lid. Do not turn.
Pork loin	approx. 500-600 g	180 W, 35-40 mins	0		180-190	Ovenware without lid.
Meat loaf	approx. 750 g	360 W, 30-35 mins	0		200-210	Ovenware without lid.
Chicken, whole	approx. 1000-1200 g	360 W, 30-40 mins	0		230-250	Ovenware with lid. Place with the breast side up. Do not turn.
Chicken pieces, e.g. chicken quarters	approx. 800 g	360 W, 20-30 mins	0		230-250	Ovenware without lid. Place with the skin side up. Do not turn.
Duck	approx. 1500-1700 g	180 W, 70-80 mins	0		220-240	Ovenware with lid. Do not turn.
Duck breast	approx. 500 g	180 W, 15-20 mins	0		3	Ovenware without lid. Place with the skin side up. Do not turn.
Duck breast, 2 pieces	250-300 g each					
Goose breast, goose legs	700-900 g	180 W, 30-40 mins	0		2	Deep ovenware without lid. Do not turn.
Fish, scalloped	approx. 500 g	600 W, 10-15 mins	0		3	Ovenware without lid. Defrost frozen fish before cooking.

* Make cuts in the pork rind.

Dish	Quantity	Weight	Level	Type of heating	Grill setting	Cooking time in minutes
Steaks, 2-3 cm thick	2-3 pieces	approx. 200 g each	1+3**		3	1st side: approx. 10-15
					3	2nd side: approx. 5-10
Neck steaks, 2-3 cm thick	2-3 pieces	approx. 120 g each	1+3**		2	1st side: approx. 15-20
					2	2nd side: approx. 10-15
Grilled sausages	4-6 pieces	approx. 150 g each	1+3**		3	1st side: approx. 10-15
					3	2nd side: approx. 5-10
Fish steak*	2-3 pieces	approx. 150 g each	1+3**		3	1st side: approx. 10-12
					3	2nd side: approx. 8-12
Fish, whole,* e.g. trout	2-3 pieces	approx. 300 g each	1+3**		2	1st side: approx. 10-15
					2	2nd side: approx. 10-15
Toast	12 slices	-	3		3	1st side: approx. 3-5
					3	2nd side: approx. 2-3
Toast with topping	2-4 slices***	-	1+3**		3	Depending on topping: 8-10

* Grease the wire rack first with oil.

** Slide the wire rack in at level 3 and the glass tray at level 1.

*** Toast the slices of bread in advance.

Tips for roasting and grilling

The table does not contain information for the weight of the joint.	For small roasts, select a higher temperature and a shorter cooking time. For larger roasts, select a lower temperature and a longer cooking time.
How to tell when the roast is ready.	Use a meat thermometer (available from specialist shops) or carry out a "spoon test". Press down on the roast with a spoon. If it feels firm, it is ready. If the spoon can be pressed in, it needs to be cooked for a little longer.
The roast looks good but the juices are burnt.	Next time, use a smaller roasting dish or add more liquid.
The roast looks good but the juices are too clear and watery.	Next time, use a larger roasting dish and add less liquid.
The roast is not well-done enough.	Cut the roast into slices. Prepare the gravy in the roasting dish and place the slices of roast meat in the gravy. Finish cooking the meat using the microwave only.



Bakes, gratins

The table applies to dishes placed in a cold oven.

Place the bake in microwaveable ovenware on the cooking compartment floor.

Use large flat ovenware for bakes and gratins. Food takes longer to cook in narrow, deep containers and browns more on top.







Bakes and gratins should be left to cook in the oven for a further 5 minutes after the oven has been switched off.

Dish	Quantity	Ovenware	Level	Microwave in watts	Cooking time in minutes	Type of heating	Temperature °C
Sweet bakes, e.g. quark bake with fruit	approx. 1500 g	Shallow dish 4-5 cm	0	180 W	25-35		130-150
Savoury bakes made from cooked ingredients, e.g. pasta bake	approx. 1000 g	Shallow dish 4-5 cm	0	600 W	20-30		160-190
Savoury bakes made from raw ingredients, e.g. potato gratin	approx. 1100 g	Flat ovenproof dish	0	600 W	25-35		170-180

Frozen convenience products

Please observe the instructions on the packaging.

The values in the table apply to food placed in a cold oven.

Dish	Ovenware	Level	Type of heating	Temperature °C	Cooking time in minutes
Strudel with fruit filling*	Glass tray	2		200-220	40-50
Chips	Glass tray	2		210-230	20-30
Pizza	Wire rack	2		180-200	10-20
Pizza baguette	Wire rack	2		160-190	15-20
Croquettes	Glass tray	2		200-220	20-30
Rösti	Glass tray	2		200-220	20-30

* Preheat the oven for 5 minutes.

Test dishes

In accordance with EN 60705, IEC 60705, DIN 44547 and EN 60350

The quality and function of microwave combination appliances are tested by testing institutes using the following dishes.

Microwave defrosting

Dish	Microwave output setting in watts, cooking time in minutes	Notes
Meat, 500 g	180 W, 7 mins +90 W, 8-12 mins or defrost "Minced meat" programme	Place the 22 cm diameter Pyrex dish on the oven floor.

Microwave cooking

Dish	Microwave output setting in watts, cooking time in minutes	Notes
Custard, 1,000 g	600 W, 11-12 mins + 180 W, 15-20 mins	Place Pyrex dish on the oven floor.
Sponge, 475 g	600 W, 8-10 mins	Place the 22 cm diameter Pyrex dish on the oven floor.
Meat loaf, 900 g	600 W, 25-30 mins	Place the Pyrex dish on the oven floor.

Combined microwave cooking

Dish	Microwave output setting in watts, cooking time in minutes	Type of heating	Temperature in °C, grill setting	Notes
Potato gratin	360 W, 30-35 mins	~~~~~	1	Place the 22 cm diameter Pyrex dish on the oven floor.
Cake	180 W, 20-25 mins	✦	190-200	Place the 22 cm diameter Pyrex dish on the wire rack at level 1.
Chicken	360 W, 30-35 mins	~~~~~ ✦	240	Put the chicken breast-side down in deep ovenware without a lid and place on the cooking compartment floor. Turn halfway through the cooking time.

In accordance with DIN 44547 and EN 60350

Baking

The values in the table apply to food placed in a cold oven.

Dish	Ovenware and notes	Level	Type of heating	Temperature °C	Baking time in minutes
Piped cookies	Glass tray	2	✦	160-170	30-35
Small Cakes*	Glass tray	2	✦	160-170	25-30
Hot water sponge cake	Springform cake tin on the wire rack	1	✦	170-180	45-50
Yeast cakes on a baking tray	Glass tray	2	✦	160-180	50-60
Apple pie	Dark springform cake tin, dia. 20 cm, directly on the wire rack	2	✦	170-190	80-100

* Preheat the oven for 5 minutes.

Grilling

The values in the table apply to food placed in a cold oven.

Dish	Accessories	Level	Grill ^{~~~~~}	Cooking time in minutes
Toast	Wire rack	3	3	4-5
Beefburgers, x 12*	Wire rack and glass tray	3+1	3	30-35

* Turn after 1/2 of the cooking time.

Acrylamide in foodstuffs

Which foods are affected?

Acrylamide is mainly produced in grain and potato products that are heated to high temperatures, such as potato crisps, chips, toast, bread rolls, bread, fine baked goods (biscuits, gingerbread, cookies).

Tips for keeping acrylamide to a minimum when preparing food	
General	Keep cooking times to a minimum. Cook meals until they are golden brown, but not too dark. Large, thick pieces of food contain less acrylamide.
Baking	With Hot air, max. 180 °C.
Biscuits	Egg or egg yolk reduce the formation of acrylamide. Spread out a single layer evenly on the glass tray.
Oven chips	Cook at least 400 g at once on a glass tray so that the chips do not dry out.

Gaggenau Hausgeräte GmbH
Carl-Wery-Straße 34
81739 München
GERMANY
www.gaggenau.com

GAGGENAU



9000926816 en (961115)