

CI 282

Hob

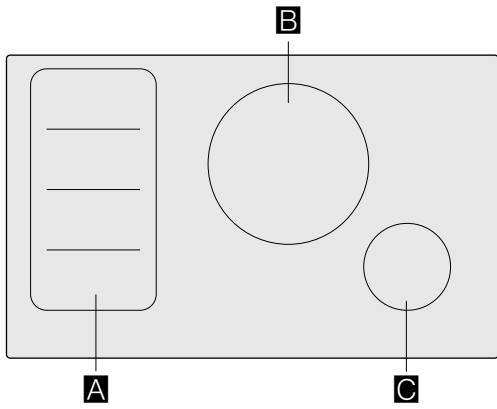

		g*	b*
A		2.200 W	3.700 W
		3.300 W	3.700 W
B	Ø 28	2.600 W	3.700 W
C	Ø 14,5	1.400 W	2.200 W

* IEC 60335-2-6

Table of contents

Intended use	4
Important safety information	5
Causes of damage	6
Overview	6
Protecting the environment	7
Energy-saving advice	7
Environmentally-friendly disposal	7
Cooking with induction	7
Advantages of induction cooking	7
Cookware	7
Getting to know your appliance	9
The control panel	9
The hotplates	10
Residual heat indicator	10
Twistpad with twist knob	11
Removing the twist knob	11
Storing the twist knob	11
Operating the appliance	11
Switching the hob on and off	11
Setting a hotplate	11
Chef's recommendations	12
Flex function	15
Advice on using cookware	15
As two independent hotplates	15
As a single hotplate	15
Transfer function	16
Professional chef function	17
Activation	17
Deactivating	17
Changing settings	17
Timer functions	18
Cooking timer	18
The short-term timer	18
Stopwatch function	19
Saucepan booster function	19
Activating	19
Deactivating	19
Frying pan booster function	20
Recommendations for use	20
Activating	20
Deactivating	20

Keep-warm function	21
Activating	21
Deactivating	21
Automatic functions	21
Types of automatic functions	21
Suitable cookware	22
Sensors and special accessories	22
Functions and heat settings	23
Recommended dishes	26
Preparation and maintenance of the wireless temperature sensor	31
Declaration of Conformity	33
Childproof lock	33
Activating and deactivating the childproof lock	33
Display cleaning protection	34
Automatic safety cut-out	34
Basic settings	35
To access the basic settings	36
Suitability test of tableware	36
Cleaning	37
Hob	37
Hob surround	37
Twist knob	37
Wireless temperature sensor	37
Frequently Asked Questions (FAQ)	38
What to do in the event of a fault	40
After-sales service	42

Additional information on products, accessories, replacement parts and services can be found at www.gaggenau.com and in the online shop www.gaggenau-eshop.com

⚠ Intended use

Read these instructions carefully. Please keep the instruction and installation manual, as well as the appliance certificate, in a safe place for later use or for subsequent owners.

Check the appliance after removing it from the packaging. If it has suffered any damage in transport, do not connect the appliance, contact the Technical Assistance Service and provide written notification of the damage caused, otherwise you will lose your right to any type of compensation.

This appliance must be installed according to the installation instructions included.

This appliance is intended for private domestic use and the household environment only. The appliance must only be used for the preparation of food and beverages. The cooking process must be supervised. A short cooking process must be supervised without interruption. Only use the appliance in enclosed spaces.

This appliance is intended for use up to a maximum height of 4000 metres above sea level.

Do not use covers. These can cause accidents, due to overheating, catching fire or materials shattering, for example.

Do not use inappropriate child safety shields or hob guards. These can cause accidents.

This appliance is not intended for operation with an external clock timer or a remote control.

This appliance may be used by children over the age of 8 years old and by persons with reduced physical, sensory or mental capabilities or by persons with a lack of experience or knowledge if they are supervised or are instructed by a person responsible for their safety how to use the appliance safely and have understood the associated hazards.

Children must not play with, on, or around the appliance. Children must not clean the appliance or carry out general maintenance unless they are at least 8 years old and are being supervised.

Keep children below the age of 8 years old at a safe distance from the appliance and power cable.

Always monitor the cooking process. Short cooking processes must be monitored continuously.

When using the cooking functions, set the hotplate on which you have placed the saucepan with the temperature sensor.

We advise that you exercise caution using or standing near an induction hob while it is in operation, if you wear a pacemaker or a similar medical device. Consult your doctor or the device manufacturer concerning its conformity or any possible incompatibilities,

⚠ Important safety information

Risk of fire!

- Hot oil and fat can ignite very quickly. Never leave hot fat or oil unattended. Never use water to put out burning oil or fat. Switch off the hotplate. Extinguish flames carefully using a lid, fire blanket or something similar.
- The hotplates become very hot. Never place combustible items on the hob. Never place objects on the hob.
- The appliance gets hot. Do not keep combustible objects or aerosol cans in drawers directly underneath the hob.
- The hob switches off automatically and can no longer be operated. It may switch on unintentionally at a later point. Switch off the circuit breaker in the fuse box. Contact the after-sales service.

Risk of burns!

- The hotplates and surrounding area (particularly the hob surround, if fitted) become very hot. Never touch the hot surfaces. Keep children at a safe distance.
- The hotplate heats up but the display does not work. Switch off the circuit breaker in the fuse box. Contact the after-sales service.
- Metal objects on the hob quickly become very hot. Never place metal objects (such as knives, forks, spoons and lids) on the hob.
- After each use, always turn off the hob at the main switch. Do not wait until the hob turns off automatically after the pan is removed.

Risk of electric shock!

- Incorrect repairs are dangerous. Repairs may only be carried out and damaged power cables replaced by one of our trained after-sales technicians. If the appliance is defective, unplug the appliance from the mains or switch off the circuit breaker in the fuse box. Contact the after-sales service.
- Do not use any high-pressure cleaners or steam cleaners, which can result in an electric shock.

- A defective appliance may cause electric shock. Never switch on a defective appliance. Unplug the appliance from the mains or switch off the circuit breaker in the fuse box. Contact the after-sales service.
- Cracks or fractures in the glass ceramic may cause electric shocks. Switch off the circuit breaker in the fuse box. Contact the after-sales service.

Hazard due to magnetism!

- The removable control element is magnetic. Magnets may affect electronic implants, e.g. heart pacemakers or insulin pumps. Thus, for persons with electronic implants: avoid carrying the control element in clothing pockets; keep a minimum distance of 10 cm to heart pacemaker or device.
- The wireless temperature sensor is magnetic. The magnetic elements in it may damage electronic implants, e.g. pacemakers or insulin pumps. People fitted with electronic implants should therefore not carry the temperature sensor in their pockets and always keep it at least 10 cm away from their pacemaker or similar medical device.

Malfunction risk!

The hob is equipped with a fan in the lower section. If there is a drawer under the hob it should not be used to store small objects or paper, since they could damage the fan or interfere with the cooling if they are sucked into it.

There should be a minimum of 2 cm between the contents of the drawer and fan intake.

Risk of injury!

- The battery in the wireless temperature sensor may become damaged or explode if it gets too hot. Remove the sensor from the hob after cooking and do not store it near sources of heat.
- The temperature sensor may be very hot when removing it from the saucepan. Wear oven gloves or use a tea towel to remove it.
- When cooking in a bain marie, the hob and cooking container could shatter due to overheating. The cooking container in the

bain marie must not directly touch the bottom of the water-filled pot. Only use heat-resistant cookware.

- Saucepans may suddenly jump due to liquid between the pan base and the hotplate. Always keep the hotplate and saucepan bases dry.

Causes of damage

Caution!

- Rough pan bases may scratch the hob.
- Avoid leaving empty pots and pans on the hotplate. Doing so may cause damage.
- Do not place hot pans on the control panel, the indicator area, or the hob frame. Doing so may cause damage.
- Hard or pointed objects dropped on the hob may damage it.
- Aluminium foil and plastic containers will melt if placed on the hotplate while it is hot. The use of laminated sheeting is not recommended on the hob.

Overview

You will find the most frequently caused damage in the following table:

Damage	Cause	Measure
Stains	Boiled over food.	Remove boiled over food immediately with a glass scraper.
	Unsuitable cleaning agent.	Only use cleaning agents that are suitable for this type of hob.
Scratches	Salt, sugar and sand.	Do not use the hob as a work surface or storage space.
	Cookware with rough bases scratch the hob.	Check the cookware.
Discolouration	Unsuitable cleaning agent.	Only use cleaning agents that are suitable for this type of hob.
	Pan abrasion.	Lift pots and pans when moving them.
Chips	Sugar, food with a high sugar content.	Remove boiled over food immediately with a glass scraper.

Protecting the environment

In this section, you can find information about saving energy and disposing of the appliance.

Energy-saving advice

- Always use the correct lid for each pan. Cooking without a lid uses a lot more energy. Use a glass lid to provide visibility and avoid having to lift the lid.
- Use pans with flat bases. Bases that are not flat use a lot more energy.
- The diameter of the pan base must match the size of the hotplate. Please note: pan manufacturers usually provide the diameter for the top of the pan, which is usually larger than the diameter of the pan base.
- Use a small pan for small amounts of food. A large pan which is not full uses a lot of energy.
- Use little water when cooking. This saves energy and preserves all the vitamins and minerals in vegetables.
- Select the lowest power level to maintain cooking. If the power level is too high, energy is wasted.

Environmentally-friendly disposal

Dispose of packaging in an environmentally-friendly manner.



This appliance is labelled in accordance with European Directive 2012/19/EU concerning used electrical and electronic appliances (waste electrical and electronic equipment - WEEE). The guideline determines the framework for the return and recycling of used appliances as applicable throughout the EU.

The wireless temperature sensor is battery-powered. Dispose of used batteries in an environmentally responsible manner.

Cooking with induction

Advantages of induction cooking

Induction cooking is very different from traditional cooking methods, as heat builds up directly in the item of cookware. This offers numerous advantages:

- Saves time when boiling and frying.
- Saves energy.
- Easier to care for and clean. Spilled food does not burn on as quickly.
- Heat control and safety – the hob increases or decreases the heat supply as soon as the user changes the setting. The induction hotplate stops the heat supply as soon as the cookware is removed from the hotplate, without having to switch it off first.

Cookware

Only use ferromagnetic cookware for induction cooking, such as:

- Cookware made from enamelled steel
- Cookware made from cast iron
- Special induction-compatible cookware made from stainless steel.

You can check whether the cookware is suitable for induction cooking. → "Suitability test of tableware"

To achieve a good cooking result, the ferromagnetic area on the base of the pan should match the size of the hotplate. If a hotplate does not detect the cookware, try placing the cookware on another hotplate with a smaller diameter.

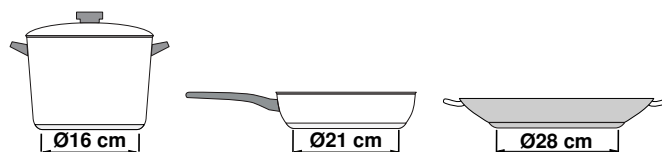

If the only hotplate being used is the flexible cooking zone, larger cookware that is particularly suited to this zone can be used. You can read more information on the positioning of the cookware here → "Flex function"



Some induction cookware does not have a fully ferromagnetic base:

- If the base of the cookware is only partially ferromagnetic, only the area that is ferromagnetic will heat up. This may mean that heat will not be distributed evenly. The non-ferromagnetic area may not heat up to a sufficient temperature for cooking.

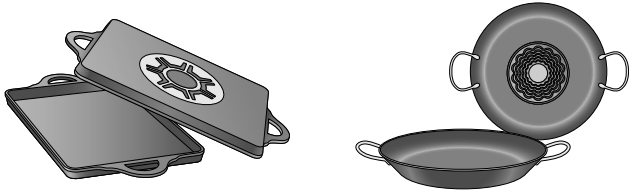

- The ferromagnetic area will also be reduced if the material from which the base of the cookware is made contains aluminium, for example. This may mean that the cookware will not become sufficiently hot or even that it will not be detected.

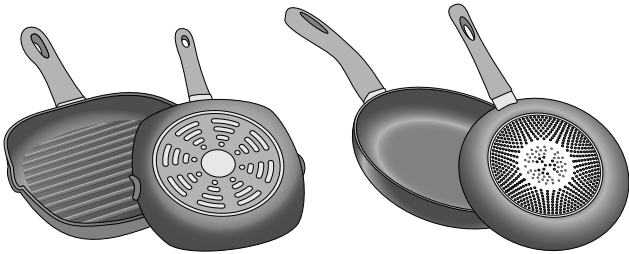

Unsuitable pans

Never use diffuser hobs or pans made from:

- common thin steel
- glass
- earthenware
- copper
- aluminium

Properties of the base of the cookware

The material(s) from which the base of the cookware is made can affect the cooking result. Using pots and pans made from materials that distribute heat evenly through them, such as stainless-steel pans with a three-layer base, saves time and energy.

Use cookware with a flat base; if the base of the cookware is uneven, this may impair the heat supply.

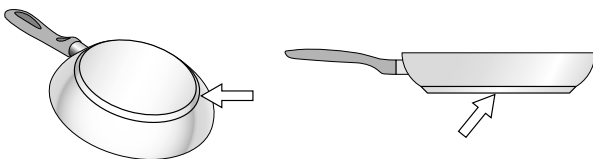

Absence of pan or unsuitable size

If no pan is placed on the selected hotplate, or if it is made of unsuitable material or is not the correct size, the power level displayed on the hotplate indicator will flash. Place a suitable pan on the hotplate to stop the flashing. If this takes more than 90 seconds, the hotplate will switch off automatically.

Empty pans or those with a thin base

Do not heat empty pans, nor use pans with a thin base. The hob is equipped with an internal safety system. However, an empty pan may heat up so quickly that the "automatic switch off" function may not have time to react and the pan may reach very high temperatures. The base of the pan could melt and damage the glass on the hob. In this case, do not touch the pan and switch the hotplate off. If it fails to work after it has cooled down, please contact the Technical Assistance Service.

Pan detection

Each hotplate has a lower limit for pan detection. This depends on the diameter of the ferromagnetic area of the cookware and the material from which its base is made. For this reason, you should always use the hotplate that best matches the diameter of the base of the pan.

Getting to know your appliance

You can find information on the dimensions and power of the hotplates in the overview. → "" on page 2

The control panel

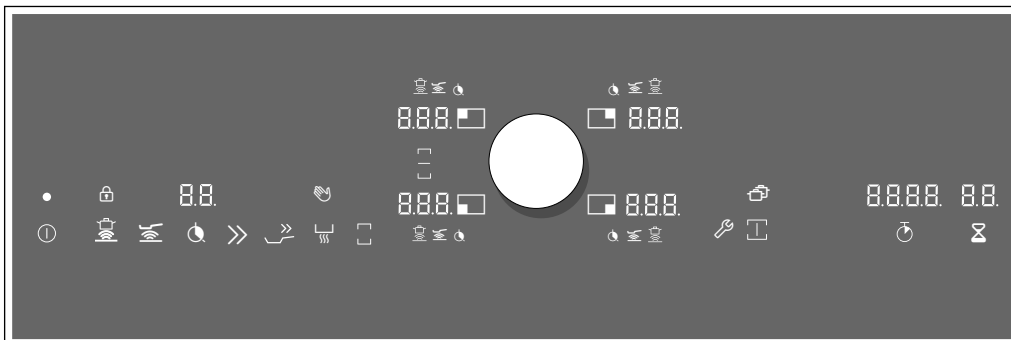

Touch keys

	Main switch
	Cooking sensor function
	Frying sensor function
	Timer function
	Saucepan booster function
	Frying pan booster function
	Keep-warm function
	Flex function
	Basic settings
	Professional chef function
	Stopwatch
	Timer

Indicators

	Operating status
	Hotplate
	Heat settings
	Cooking sensor function
	Frying sensor function
	Cooking timer
	Saucepan booster function
	Frying pan booster function
	Keep-warm function
	Residual heat
	Timer function
	Stopwatch function
	Display cleaning protection

Indicators

	Childproof lock
	Flex function activated
	Flex function deactivated
	Transfer function

Touch keys

When the hob heats up, the symbols for the touch keys available at this time light up.

Touching a symbol activates the associated function. A confirmation signal sounds.

Notes

- The corresponding symbols for the touch keys light up depending on whether they are available. The indicators for the available functions light up in white. Once a function is selected, its indicator lights up in orange.
- Always keep the control panel clean and dry. Moisture can prevent it from working properly.

The hotplates

Hotplates

○ / ☐ Simple hotplate Use cookware that is a suitable size.

☐ Flexible cooking zone See section → "Flex function"

Only use cookware that is suitable for induction cooking; see section → "Cooking with induction"

Residual heat indicator

The hob has a residual heat indicator for each hotplate. This indicates that a hotplate is still hot. Do not touch a hotplate while the residual heat indicator is lit up.

The following are shown depending on the amount of residual heat:

- Display H : High temperature
- Display h : Low temperature

If you remove the cookware from the hotplate during cooking, the residual heat indicator and the selected heat setting will flash alternately.

When the hotplate is switched off, the residual heat indicator will light up. Even after the hob has been switched off, the residual heat indicator will stay lit for as long as the hotplate is still warm.

Twistpad with twist knob

The twistpad is the control panel where you can use the twist knob to select the hotplates and heat settings.

The twist knob is magnetic and is placed in the middle of the area marked on the twistpad. To activate a hotplate, press the twist knob so that it tilts in the appropriate area for the required hotplate. Turning the twist knob selects the heat setting.

Position the twist knob on the twist pad so that it is in the centre of the indicators which delimit the twist pad area.

Note: Even if the twist knob is not entirely central, this will not affect how the twist knob works.

Removing the twist knob

Removing the twist knob activates the wipe protection function.

The twist knob can be removed during cooking. The wipe protection function is activated for 10 minutes. If the twist knob is not returned to its position before this time elapses, the hob will switch off.

Risk of fire!

If a metallic object is placed in the twist pad area during these 10 minutes, the hob may continue to heat up. For this reason, always switch off the hob using the main switch.

Storing the twist knob

A strong magnet is located inside of the twist knob. Keep the twist knob away from magnetic data carriers such as credit cards and cards with magnetic strips. Otherwise, these data carriers may be damaged beyond repair.

The magnet may also cause faults on televisions and screens.



Note: The twist knob is magnetic. Metal particles stuck to the bottom may scratch the surface of the hob. Always clean the twist knob thoroughly.

Operating the appliance

This chapter explains how to set a hotplate. The table shows heat settings and cooking times for various meals.

Switching the hob on and off

Switch the hob on and off using the main switch.

To switch on: Position the twist knob on the control panel. Touch the  symbol. The symbols for the hotplates and the functions available at this time light up.  lights up next to the hotplates. The hob is ready for use.

To switch off: Touch the  symbol until the display goes out. All hotplates are switched off. The residual heat indicator remains lit until the hotplates have cooled down sufficiently.

Notes

- The hob switches off automatically if all hotplates have been switched off for more than 20 seconds.
- The selected settings are stored for 5 seconds after the hob has been switched off. If the hotplate is switched back on during this period, the previously set heating settings flash. To apply these settings, tap on the twist knob within the next 5 seconds. If you do not tap the twist knob or if you touch a different sensor key, all previous settings will be deleted.

Setting a hotplate

Set the required hotplate using the twist knob.

Heat setting 1 = lowest setting.

Heat setting 9 = highest setting.

Every heat setting has an intermediate setting. This is shown in the hotplate display as **.5**.

Selecting a hotplate and heat setting

The hob must be switched on.

- 1 Select the hotplate. To do this, touch the twist knob in the appropriate area for the required hotplate.
- 2 Within the next 10 seconds, turn the twist knob until the required heat setting appears in the heat setting display.

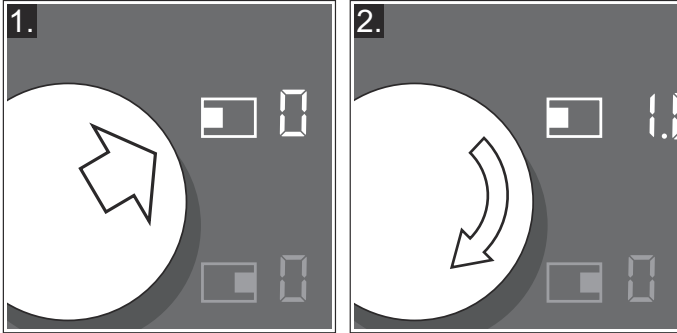

The heat setting is set.

Notes

- When placing an item of cookware on the flexible cooking zone, it must be positioned correctly according to size; see section → "Flex function". The cookware is detected and the hotplate is selected automatically. You can change the settings.
- If the indicators flash after you have changed the settings, check whether the cookware is suitable for induction cooking. See section → "Suitability test of tableware"

Changing the heat setting

Select the hotplate and change the heat setting using the twist knob.

Switching off the hotplate

Select the hotplate and turn the twist knob until  appears. The hotplate switches itself off and the residual heat indicator lights up.

Notes

- If there is no cookware on the induction hotplate, the heat setting display flashes. After a while, the hotplate will switch itself off.
- If there is cookware on the hotplate before switching the hob on, this is detected at most 20 seconds after touching the main switch and the hotplate is selected automatically. Set the heat setting within the next 10 seconds. Otherwise the hotplate will switch itself off again after 20 seconds.
Even if there are several pots and pans on the hob when it is switched on, only one item of cookware is detected.

Chef's recommendations

Recommendations

- When heating up puree, cream soups and thick sauces, stir occasionally.
- Set heat setting 8 to 9 for preheating.
- When cooking with the lid on, turn the heat setting down as soon as steam escapes between the lid and the cookware. Steam does not need to escape for a good cooking result.
- After cooking, keep the lid on the cookware until you serve the food.
- To cook with the pressure cooker, observe the manufacturer's instructions.
- Do not cook food for too long, otherwise the nutrients will be lost. The kitchen clock can be used to set the optimum cooking time.
- For a more healthy cooking result, smoking oil should be avoided.
- To brown food, fry small portions in succession.
- Cookware may reach high temperatures while the food is cooking. We recommend that you use oven gloves.
- You can find recommendations for energy-efficient cooking in section → "Protecting the environment"

Cooking table

The table shows which heat setting is suitable for each type of food. The cooking time may vary depending on the type, weight, thickness and quality of the food.

	Heat setting	Cooking time (mins)
Melting		
Chocolate coating	1 - 1.	-
Butter, honey, gelatine	1 - 2	-
Heating and keeping warm		
Stew, e.g. lentil stew	1. - 2	-
Milk*	1. - 2.	-
Heating sausages in water*	3 - 4	-
Defrosting and heating		
Spinach, frozen	3 - 4	15 - 25
Goulash, frozen	3 - 4	35 - 55
Poaching, simmering		
Potato dumplings*	4. - 5.	20 - 30
Fish*	4 - 5	10 - 15
White sauces, e.g. Béchamel sauce	1 - 2	3 - 6
Whisked sauces, e.g. sauce béarnaise, hollandaise	3 - 4	8 - 12
Boiling, steaming, braising		
Rice (with double the volume of water)	2. - 3.	15 - 30
Rice pudding***	2 - 3	30 - 40
Unpeeled boiled potatoes	4. - 5.	25 - 35
Boiled potatoes	4. - 5.	15 - 30
Pasta, noodles*	6 - 7	6 - 10
Stew	3. - 4.	120 - 180
Soups	3. - 4.	15 - 60
Vegetables	2. - 3.	10 - 20
Vegetables, frozen	3. - 4.	7 - 20
Cooking in a pressure cooker	4. - 5.	-
Braising		
Roulades	4 - 5	50 - 65
Pot roast	4 - 5	60 - 100
Goulash***	3 - 4	50 - 60

* Without lid

** Turn several times

*** Preheat to heat setting 8 - 8.

	Heat setting	Cooking time (mins)
Roasting/frying with little oil*		
Escalope, plain or breaded	6 - 7	6 - 10
Escalope, frozen	6 - 7	8 - 12
Chop, plain or breaded**	6 - 7	8 - 12
Steak (3 cm thick)	7 - 8	8 - 12
Poultry breast (2 cm thick)**	5 - 6	10 - 20
Poultry breast, frozen**	5 - 6	10 - 30
Rissoles (3 cm thick)**	4 - 5.	20 - 30
Hamburgers (2 cm thick)**	6 - 7	10 - 20
Fish and fish fillet, plain	5 - 6	8 - 20
Fish and fish fillet, breaded	6 - 7	8 - 20
Fish, breaded and frozen, e.g. fish fingers	6 - 7	8 - 15
Scampi, prawns	7 - 8	4 - 10
Sautéing fresh vegetables and mushrooms	7 - 8	10 - 20
Stir-fry, vegetables, meat cut in Asian-style strips	7 - 8	15 - 20
Frozen dishes, e.g. roasted dishes	6 - 7	6 - 10
Pancakes (baked in succession)	6 - 7.	-
Omelette (cooked in succession)	3 - 4.	3 - 6
Fried eggs	5 - 6	3 - 6
Deep-fat frying* (150-200 g per portion in 1-2 l oil, deep-fat fried in portions)		
Frozen products, e.g. chips, chicken nuggets	8 - 9	-
Croquettes, frozen	7 - 8	-
Meat, e.g. chicken portions	6 - 7	-
Fish, breaded or in beer batter	6 - 7	-
Vegetables, mushrooms, breaded or battered, tempura	6 - 7	-
Small baked items, e.g. doughnuts, fruit in batter	4 - 5	-

* Without lid

** Turn several times

*** Preheat to heat setting 8 - 8.

Flex function

You can use the flexible cooking zone as a single hotplate or as two independent hotplates, as required.

It consists of four inductors that work independently of each other. If the flex function is in use, only the area that is covered by cookware is activated.

Advice on using cookware

To ensure that the cookware is detected and heat is distributed evenly, correctly centre the cookware:

As a single hotplate

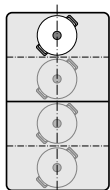

Diameter smaller than or equal to 13 cm
Place the cookware on one of the four positions that can be seen in the illustration.

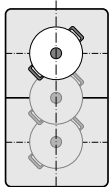

Diameter greater than 13 cm
Place the cookware on one of the three positions that can be seen in the illustration.

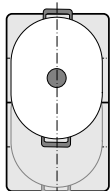

If the cookware takes up more than one hotplate, place it starting on the upper or lower edge of the flexible cooking zone.

As two independent hotplates

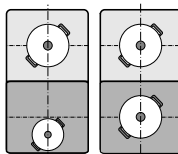

The front and rear hotplates each have two inductors and can be used independently of each other. Select the required heat setting for each of the hotplates. Use only one item of cookware on each hotplate.

As two independent hotplates

The flexible cooking zone is used like two independent hotplates.



Activating

See section → "Operating the appliance"

As a single hotplate

Using the entire cooking zone by connecting both hotplates.

Linking the two hotplates

- 1 Set down the cookware. Select one of the two hotplates in the flexible cooking zone and set the heat setting.
- 2 Touch the  symbol. The  indicator lights up.

The flexible cooking zone has now been activated. The heat setting appears in the two displays for the flexible cooking zone.

Notes

- If both hotplates are set to different heat settings before being linked, switch both hotplates to 0 on activation.
- If there is a cooking timer programmed for one hotplate, this will also be assigned to the second hotplate when the two are linked.

Changing the heat setting

Select one of the two hotplates assigned to the flexible cooking zone and set the heat setting using the twist knob.



Adding new cookware

- 1 Set down additional cookware in the appropriate position according to size. If correctly positioned, cookware is detected and the hotplate is selected automatically; the corresponding part of the display  flashes.
- 2 Use the twist knob to confirm the setting within 90 seconds. The indicators stop flashing and the cookware is heated up.

Note: If the indicators continue to flash, check whether the cookware is suitable for induction cooking → "Suitability test of tableware"

Note: If the cookware is moved to the hotplate being used or lifted up, the hotplate begins an automatic search and the heat setting selected previously is retained.

Unlinking the two hotplates

- 1 Select one of the two hotplates assigned to the flexible cooking zone.
- 2 Touch the  symbol.
- 3 The  symbol appears in the cooking zone display.

This deactivates the flexible cooking zone. The two hotplates will now function independently.

Note: If the hotplate is switched off, and then switched back on again later, the flexible cooking zone is reset to function as two independent hotplates.

Transfer function

You can use this function to transfer the settings of one hotplate to another.

This function can also be used on the flexible cooking zones.

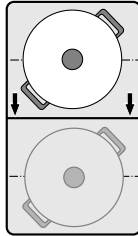

Note: You can find additional information on the correct positioning of the cookware in the section on → "Flex function"

- 1 Remove any cookware from the hob.
The hotplate indicator will start flashing. The hotplate will not heat up.

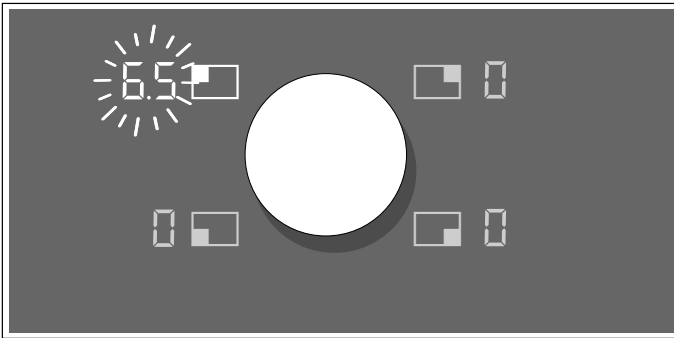

- 2 Set down the cookware on a flexible hotplate within the next 90 seconds. The new hotplate is detected and the  symbol lights up. The heat setting that has been applied will flash in the hotplate display.

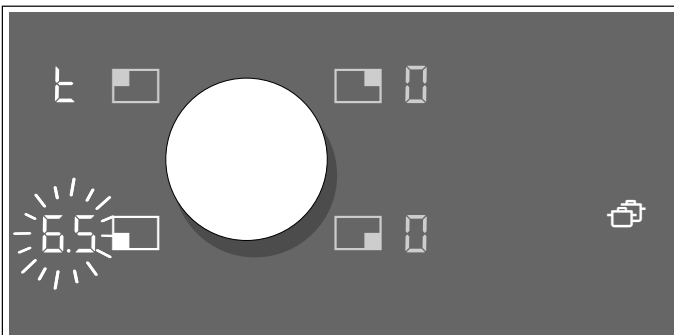

- 3 Select the new hotplate within 90 seconds using the twist knob. The settings have been transferred.

Notes

- Move the cookware to a hotplate which is not switched on, which has not yet been preset and on which no other cookware has yet been placed.
- If the Flex function is activated by moving an item of cookware across the flexible cooking zone, the settings will be automatically applied.

- A set cooking time or cooking sensor function will also be transferred to the new hotplate. The frying sensor function and the booster functions will not be transferred.
- During the adjustment time, you can return the cookware to the original hotplate. The hotplate will then continue to heat up using the previous setting, without the need for confirmation.

Professional chef function

You can use the professional chef function to display the preset heat settings for each hotplate. Set down a suitable item of cookware within 9.5 minutes to apply the default value.

Activation

- 1 Switch on the hob.
- 2 Touch the  symbol.
The preset heat settings will light up in the hotplate displays. The flexible cooking zones are linked and cannot be separated.

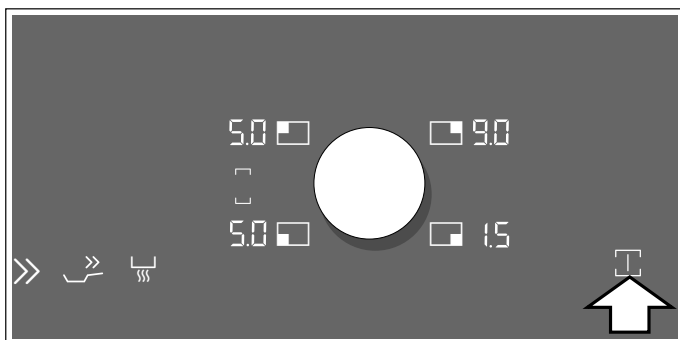





- 3 Set down a suitable item of cookware within 8 minutes. Once the cookware has been detected, the respective hotplate will be selected. You can adjust the heat setting using the twist knob. The heat setting displays for the unoccupied hotplates will start flashing if the adjustment time elapses.
- 4 Touch the  symbol again within 90 seconds to extend the professional chef function. If you do not touch the symbol, the unused hotplates will switch themselves off.



Notes

- Booster functions for saucepans and frying pans and the keep-warm function can also be set in professional chef mode. The flexible cooking zone cannot be separated.
- If an unsuitable item of cookware is set down (e.g. aluminium cookware), the heat setting display will flash until this cookware is removed. To check whether your cookware is suitable for induction cooking, refer to the section on → "Suitability test of tableware".

Deactivating

To end the function immediately: Touch the  symbol. Switch all hotplates to heat setting . The  symbol lights up white.

Function ends automatically: If no suitable cookware is set down after 8 minutes have elapsed, the  symbol and the corresponding hotplate displays start flashing for 90 seconds. Touch the  symbol twice to switch off the function.

If you do not touch the  symbol, the professional chef function switches off automatically after 90 seconds. The  symbol lights up white and unoccupied hotplates switch to heat setting . Hotplates that are in use retain the original heat setting.

Changing settings

You can change the default values in the "Basic settings" menu. See section → "Basic settings"

Timer functions

Your hob has three timer functions:



- Cooking timer
- Timer
- Stopwatch function

Cooking timer

The hotplate automatically switches off after the time that is set has elapsed.

You can set a time of up to 99 minutes. The time elapses in the timer display in minutes and the final half a minute is displayed in seconds.

Setting procedure:

- 1 Select the hotplate and the required heat setting.
- 2 Touch the  symbol. The  display for the hotplate lights up.  lights up on the timer display.



- 3 Use the twist knob to select the required cooking time.

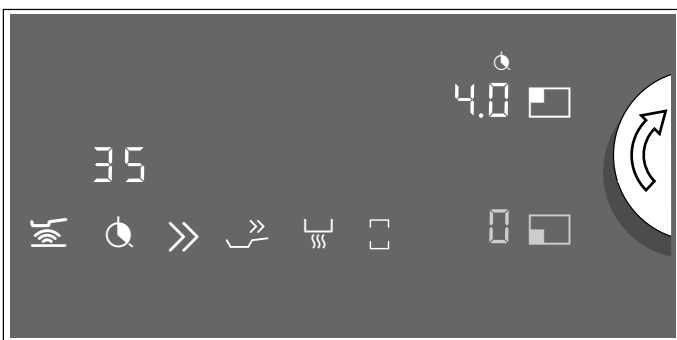

The cooking time begins to elapse.

Note: If the flexible cooking zone is selected as the only hotplate, the set time for the entire cooking zone is the same.

Frying/cooking sensor function



If a cooking time has been programmed for a hotplate and the frying sensor or cooking sensor function is activated, the cooking time will begin to count down immediately, instead of once the selected temperature setting has been reached.

Changing or deleting the time

Select the hotplate and then touch the  symbol.

Change the cooking time using the twist knob or set to  to delete it.

When the time has elapsed

The hotplate switches off. A signal sounds,  appears in the hotplate display and  flashes in the timer display. Touch any symbol or press the twist knob; the displays go out and the audible signal ceases.

Notes



- If a cooking time has been programmed for several hotplates, the cooking time that ends first will appear in the timer display. The  indicator for the hotplate lights up orange.
- Select the relevant hotplate to call up the remaining cooking time for a hotplate. The cooking time will appear for 10 seconds.

The short-term timer

You can use the short-term timer to set a time of up to 99 minutes.



This functions independently from the hotplates and from other settings. This function does not automatically switch off a hotplate.

How to activate the function



- 1 Touch the  symbol;  appears in the timer display.
- 2 Select the required time using the twist knob.
- 3 Touch the  symbol again to confirm the selected time.

The cooking time begins to elapse.

Changing or deleting the time

Touch the  symbol and use the twist knob to change the time or set it to .

When the time has elapsed

A signal sounds for three minutes.  flashes in the timer display. Touch the  symbol again: The displays go out and the audible signal ceases.

Stopwatch function

The stopwatch shows the cooking time that has elapsed so far in minutes and seconds (mm.ss). The maximum duration is 99 minutes and 59 seconds (99.59). If this value is reached, the display starts again at 00.00.

The stopwatch works independently of the hotplates and other settings. This function does not automatically switch off a hotplate.

Activating

Touch the  symbol. **00.00** appears in the stopwatch display.

The time begins to elapse.

Deactivating

Touching the  symbol stops the stopwatch function. The stopwatch displays remain lit.

If you touch the  symbol again while it is still orange, the time will continue to elapse.

If you touch and hold the  symbol, the displays will go out.

The function is deactivated.

Saucepan booster function

This function allows large volumes of water to be heated up even more quickly than with power setting **5**. The saucepan booster function temporarily increases the maximum output of the selected hotplate.

This function can always be activated for a hotplate, provided the other hotplate in the same group is not in use (see illustration).

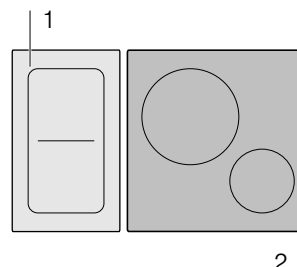

Note: The booster function can also be activated on the flexible cooking zone if this is being used as a single hotplate.

Activating

- 1 Select the hotplate.
- 2 Touch the  symbol.
The **P** indicator lights up.

The function has now been activated.

Deactivating

- 1 Select the hotplate.
- 2 Touch the  symbol, turn the twist knob or select a different function.
The **P** indicator goes out and the hotplate switches back to the **5** heat setting.

The function is deactivated.

Notes

- In certain circumstances, this function may switch itself off automatically in order to protect the electronic elements inside the hob.
- If a heat setting was set before activating the frying pan function, this will be automatically applied again after deactivating the function.

Frying pan booster function

This function enables you to heat cookware faster than when using heat setting 9.

After deactivating the function, select the appropriate heat setting for your food.

This function can always be activated for a hotplate, provided the other hotplate in the same group is not in use (see illustration).

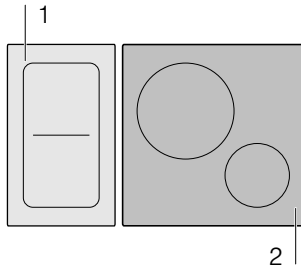



Note: The booster function for pans can also be activated on the flexible cooking zone if this is being used as a single hotplate.



Recommendations for use

- Always use cookware that has not been pre-heated.
- Use pots and pans with a flat base. Do not use cookware with a thin base.
- Never leave empty cookware, oil, butter or lard to heat up unattended.
- Do not place a lid on the cookware.
- Place the cookware on the centre of the hotplate. Ensure that the diameter of the base of the cookware corresponds to the size of the hotplate.
- You can find information on the type, size and positioning of the cookware in section

Activating

- 1 Select a hotplate.
 - 2 Touch the  symbol. The  indicator lights up.
- The function has now been activated.

Deactivating

- 1 Select a hotplate.
- 2 Touch the  symbol, turn the twist knob or select a different function. The  display goes out. The heat setting 9 lights up in the display for the hotplate.

The function is deactivated.



Notes

- In certain circumstances, this function may switch itself off automatically in order to protect the electronic elements inside the hob.
- If a heat setting was set before activating the frying pan function, this will be automatically applied again after deactivating the function.

Keep-warm function



This function is suitable for melting chocolate or butter and for keeping food warm.

Activating

- 1 Select the required hotplate.
- 2 Touch the  symbol within the next 10 seconds.  lights up on the display.

The function has now been activated.

Deactivating

- 1 Select the hotplate.
- 2 Touch the  symbol, turn the twist knob or select a different function. The  indicator goes out. The hotplate switches itself off and the residual heat indicator lights up.

The function is deactivated.

Automatic functions

The automatic functions make cooking easy and always give you excellent results. The recommended temperature settings are suitable for any type of cooking.

They enable you to cook without using excessive heat and promise the perfect cooking and frying results.

Sensors measure the heat of the saucepan or frying pan throughout the cooking process. This ensures that the power is continuously controlled and that the right temperature is maintained.

Food can be added once the selected temperature has been reached. Food will not be overheated and liquids will not boil over.

The frying sensor function is available for all hotplates.

The cooking sensor function is available on all hotplates if a wireless temperature sensor is connected.







In this section, you will find information on:

- Automatic function types
- Suitable cookware
- Sensors and special accessories
- Functions and heat settings
- Recommended dishes
- Preparing and maintaining the wireless temperature sensor

Types of automatic functions

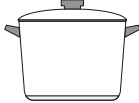

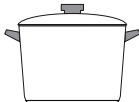



The automatic functions are used to select the best cooking type for each kind of food.

The table shows the various different function settings that are available for the automatic functions:

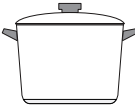
Automatic functions	Temperature settings	Cookware	Available for	Activate
Frying sensor function				
Schmoren/Braten mit wenig Fett	1, 2, 3, 4, 5		All hotplates	
Cooking sensor function	suitable temperature			
Heating/keeping warm	60-70 °C		All hotplates	
Simmering	80-90 °C		All hotplates	

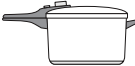
*Preheat with the lid on and fry with the lid off..

If the hob does not have a wireless temperature sensor, this can be purchased from specialist retailers or through our technical after-sales service.

Automatic functions	Temperature settings	Cookware	Available for	Activate
Boiling	90-100 °C		All hotplates	
Cooking in a pressure cooker	110-120 °C		All hotplates	
Frying with a large amount of oil in the saucepan*	170-180 °C		All hotplates	

*Preheat with the lid on and fry with the lid off..

If the hob does not have a wireless temperature sensor, this can be purchased from specialist retailers or through our technical after-sales service.

Suitable cookware

Select the hotplate the diameter of which most closely matches that of the base of the cookware and place the cookware in the centre of this hotplate.

The cooking sensor function is not suitable for frying food in a pan like you can with the frying sensor function.

There are frying pans that are perfect for using with the frying sensor function. These can be purchased from specialist retailers or through our technical after-sales service. Always quote the relevant reference number:

- **GP900001** small vessel (15 cm diameter)
- **GP900002** medium vessel (18 cm diameter)
- **GP900003** large vessel (21 cm diameter)
- **GP900004** large vessel (28 cm diameter)

These frying pans have a non-stick coating so that you can fry food with a small amount of oil.

Notes

- The frying sensor function has been configured specifically for this type and size of frying pan.
- Using a frying pan of a different size or one that is poorly positioned on the flexible cooking zones may result in the frying sensor not being activated. See the section on → "Flex function".
- Other frying pans may overheat and reach a temperature above or below the selected heat setting. Try the lowest heat setting to begin with and change it if necessary.

Any cookware that is suitable for induction cooking can be used with the cooking sensor function. You can find information on which types of cookware can be used with an induction hob in the section on → "Cooking with induction".

The automatic functions table shows which cookware is suitable for which function.

Sensors and special accessories

The sensors measure the temperature of the saucepan or frying pan throughout the cooking process. This ensures that the power is controlled with high precision and that the right temperature is maintained:

Your hob has two different temperature measuring systems:

- **Frying sensor function:** Temperature sensors are located underneath the hob. These monitor the temperature of the base of the frying pan.
- **Cooking sensor function:** A wireless temperature sensor transmits the temperature of the saucepan to the control panel. The sensor is attached to the saucepan.

A wireless temperature sensor is required for the cooking sensor function. You can purchase this from specialist retailers or from our technical after-sales service – you will need to quote the reference number **CA060300**.

You can find more information about the wireless temperature sensor in the section entitled → "Preparation and maintenance of the wireless temperature sensor"

Functions and heat settings

Frying sensor function

You can use the frying sensor function to prepare food in the frying pan with a little oil.

This function is available for all hotplates.

Advantages



- The hotplate only heats up when necessary. This saves energy. Oil and fat will not overheat.
- An audible signal will sound once the empty frying pan has reached the optimum temperature for adding oil and food.

Temperature settings

Temperature setting	Suitable for
1 Very low	Preparing and preserving sauces, sweating vegetables and frying food in extra virgin olive oil, butter or margarine.
2 Low	Frying food using extra virgin olive oil, butter or margarine, e.g. omelettes.
3 Medium - low	Frying fish and Thick food, e.g. meatballs and sausages.
4 Medium - high	Frying steaks, medium or well-done, frozen, breaded and fine foods, e.g. escalope, fresh ragout and vegetables.
5 High	Frying food at high temperatures, e.g. steaks, bloody, potato fritter and Frozen French fries.

Setting procedure

Select the appropriate temperature setting from the table. Place the empty frying pan on the hotplate.

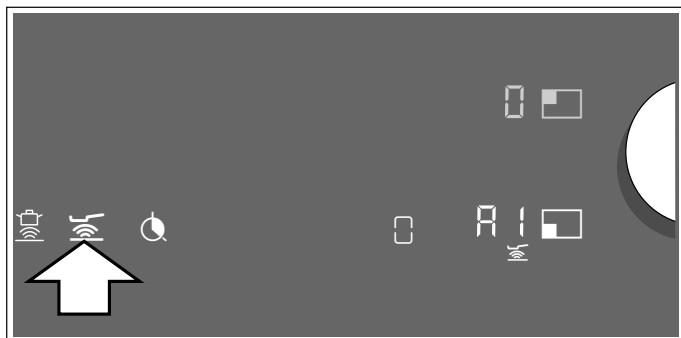

- 1 Select the hotplate and touch the  symbol. The  symbol lights up in the hotplate display and the temperature setting **A 1** is displayed.



- 2 Within the next 10 seconds, select the required temperature setting using the twist knob.

Notes

- Do not place a lid on the pan. Otherwise, the function does not activate correctly. You can use a splatter guard to prevent splashes of grease.
- Use oil or fat that is suitable for frying. If you are using butter, margarine, cold-pressed olive oil or lard, use temperature setting 1 or 2.
- Never leave a frying pan unattended during heating, regardless of whether or not it contains food.
- If the hotplate is a higher temperature than the cookware or vice versa, the temperature sensor will not be activated correctly.
- For frying with a large quantity of oil, always use the cooking sensor function. "Fry with a large quantity of oil in a saucepan", at 170-180 °C.

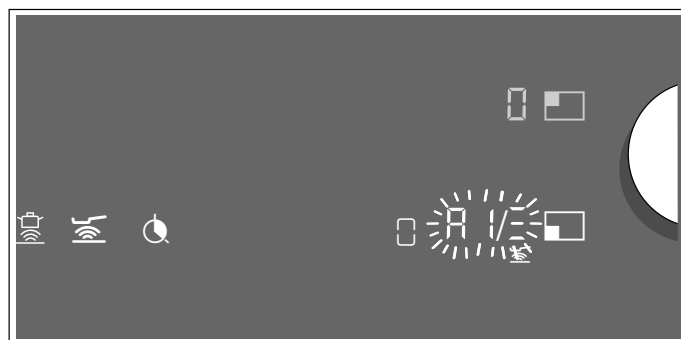

- 3 The hotplate display shows the progress of the heating process from  to  and flashes alternately with the set heat setting. Once the set frying temperature has been reached, a signal will sound and the heating indicator will go out. The heat setting is displayed again.



- 4 Once the frying temperature has been reached, add the fat and then the food to the pan.

Note: Turn the food so that it does not burn.

Switching off the frying sensor function

Select the hotplate and touch the  symbol or set the temperature setting to  using the twist knob. A signal sounds and the  symbol goes out. The function is deactivated.

Cooking sensor function (optional)

You can use this function to heat, simmer or cook food, or cook it in a pressure cooker or fry it in a saucepan with sufficient oil at a controlled temperature.

The cooking sensor function is available for all hotplates.

Benefits

- The hotplate only heats up when necessary. This saves energy. Oil or fat will not overheat. The temperature is continuously monitored. This prevents the food from spilling over. The temperature does not need to be readjusted.
- A signal will sound once the water or oil has reached the optimum temperature for adding the food. The table shows if the food needs to be added right at the start.

Notes

- Use pots and pans that have a flat base. Do not use pots and pans that have a thin or domed base.
- Fill the saucepan until its contents are above the silicone patch on the outside of the pan.
- When frying with a little oil, use the frying sensor function.
- Position the saucepan in such a way that the temperature sensor is not pointing towards a different pan.
- Do not remove the temperature sensor from the saucepan during cooking. Once the cooking process has ended, the function can be selected for another hotplate.
- Remove the temperature sensor from the saucepan after cooking. Caution: The temperature sensor may be very hot.

Temperature ranges

Cooking sensor function	Temperature range	Suitable for
Heating, Keeping warm	60 - 70 °C	e.g. soups, punch
Simmering	80 - 90 °C	e.g. rice, milk
Boiling	90 - 100 °C	e.g. pasta, vegetables
Cooking in a pressure cooker	110 - 120 °C	e.g. chicken, stew
Frying with a large amount of oil in the saucepan	170 - 180 °C	e.g. doughnuts, meatballs

Tips for cooking with the cooking sensor function

- Heating up/keeping warm: Portioned frozen products, e.g. spinach. Place the frozen product in the cookware. Add the volume of water specified by the manufacturer. Cover the cookware and set the temperature to 70 °C. Stir during cooking.

- Cooking: Thicken foods, e.g. sauces. Bring the food to the boil at the recommended temperature. Once the food has thickened, simmer at 85 °C. After the audible signal sounds, keep the food at this temperature for the required time.
- Boiling: Heat up water with the lid on. It will not boil over. Set the temperature to 100 °C.
- Cooking in a pressure cooker: Follow the manufacturer's recommendations. Continue cooking for the recommended time once the audible signal has sounded. Set the temperature to 115 °C.
- Frying with a large amount of oil in the saucepan: Heat the oil with the lid on. Once the audible signal has sounded, remove the lid and add the food. Set the temperature to 175 °C.

Notes

- Before you cook anything, make sure that the silicone patch is completely dry.
- Always cook with the lid on. Exception: "Frying with a large amount of oil in the saucepan", temperature 170 °C.
- If an audible signal does not sound, make sure that the lid is on the saucepan.
- Never leave oil unattended when it is being heated. Use oil or fat that is suitable for frying. Do not mix different cooking fats together, e.g. oil and lard. Mixtures of different fats may froth up when hot.
- If you are not satisfied with the cooking result, e.g. when cooking potatoes, next time use more water but keep the recommended temperature setting.

Setting the boiling point

The point at which water starts to boil depends on the height of your home above sea level. You can set the boiling point if water is boiling too strongly or not strongly enough. To do this, proceed as follows:

- Select the basic setting **5** see the section on → "Basic settings"
- The basic setting is 3 as standard. If your home is between 200 and 400 metres above sea level, there is no need to set the boiling point. If not, choose the correct setting from the following table according to your altitude:

Height	Setting 5
0 - 100 m.	1
100 - 200 m.	2
200 - 400 m.	3*
400 - 600 m.	4
600 - 800 m.	5
800 - 1000 m.	6
1000 - 1200 m.	7

* Basic setting

Height	Setting $\epsilon 5$
1200 - 1400 m.	8
above 1400 m.	9





* Basic setting

Note: Temperature setting 100 °C provides efficient cooking even if the water does not bubble very strongly during the heating process. However, if you are not satisfied with the boiling result, you can change the boiling point setting.

Connecting the wireless temperature sensor to the control panel

You will need to connect the wireless temperature sensor to the control panel before using the cooking sensor function for the first time.

To connect the wireless temperature sensor to the control panel, follow the instructions below:

- 1 Select basic setting $\epsilon 5$; see the section entitled → "Basic settings"
The  symbol lights up white.
- 2 Press the  symbol. A signal sounds and the  symbol lights up orange. The hotplate indicators light up white and the cooking sensor indicators on the hotplates flash.
Press the  symbol on the wireless temperature sensor within 30 seconds.

- 3 **Connection successful:** The wireless cooking sensor is detected within a few seconds. Three short beeps sound and the  symbol changes from orange to white. The cooking sensor indicators on the hotplates go out.

Connection failed: Five beeps sound. The  symbol changes immediately from orange to white and the cooking sensor indicators on the hotplates go out.

- The cooking sensor function is made available once the temperature sensor has been connected to the control panel correctly.
- If there is a fault with the temperature sensor, the connection may not be established correctly for the following reasons:
 - Bluetooth communication error.
 - You did not press the  symbol on the temperature sensor within 30 seconds of selecting a hotplate.
 - The battery in the temperature sensor has run out.

Reset the wireless temperature sensor and follow the connection procedure once again.





- If the temperature sensor and the control panel are not connected correctly due to a transmission error, follow the connection procedure once again.
If no connection can be established, inform the after-sales service.

Resetting the wireless temperature sensor

- 1 Touch and hold the  symbol for approximately 8-10 seconds.
While you are doing this, the temperature sensor's LED indicator will light up three times. When the LED lights up for the third time, it will start to reset the temperature sensor. At this point, you will need to lift your finger off the symbol.
Once the LED goes out, this means that the wireless temperature sensor has been reset.
- 2 Repeat the connection procedure from point 2.

Programming

The hob must be on.

- 1 Attach the temperature sensor to the cookware, see section → "Preparation and maintenance of the wireless temperature sensor"
- 2 Place the cookware with sufficient liquid in the middle of the desired element and always put a lid on.
- 3 Select the required hotplate using the twist knob.  appears in the display for the heat setting.
- 4 Press the  symbol in the control panel. An audible signal sounds. The  symbol lights up in the display for the hotplate.
- 5 Press the  symbol on the wireless temperature sensor on the cookware. Once the wireless temperature sensor has been detected, the default temperature of 95 °C lights up in the hotplate display.

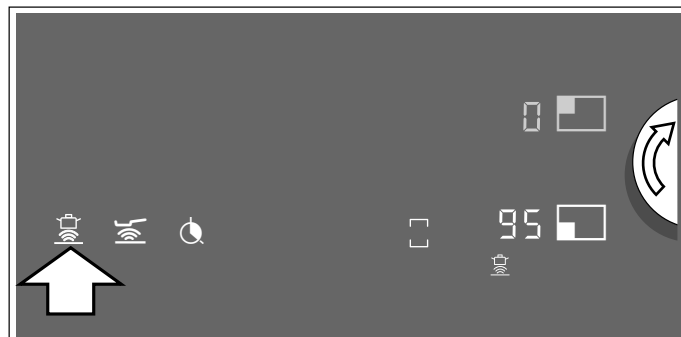

- 6 Set the required temperature using the twist knob. The temperature can be changed by increments of 5 °C.

- 7 The hotplate display shows the progress of the heating process from $\underline{\quad}$ to $\overline{\quad}$ and flashes alternately with the set temperature. Once the set temperature has been reached, an audible signal sounds and the heating indicator goes out. The selected temperature will then be displayed again.

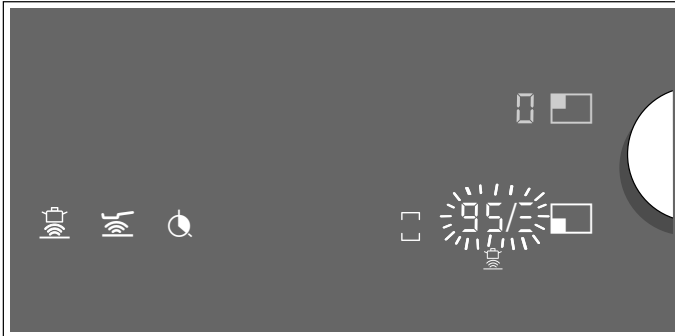

- 8 Once the signal has sounded, take the lid off and add the food. Keep the lid on during cooking.
- Note:** Do not cover the pan when using the "Frying with a large amount of oil in the saucepan" function.



You can also activate the cooking sensor function via the wireless temperature sensor. Proceed as follows:

- Set down the cookware and press the  symbol on the wireless temperature sensor.
- Select the hotplate using the twist knob.

When the function is ready, the default temperature of 95 °C is displayed.

Switching off the cooking sensor function

You can deactivate this function in a number of ways:

- Select the hotplate and touch the  symbol.
- Select the hotplate and set the temperature to  using the twist knob.
- Press the  symbol on the wireless cooking sensor.

A signal sounds and the  symbol goes out in the hotplate display. The function is deactivated.

Recommended dishes

The following table shows a selection of dishes and is arranged by food type. The temperature and the cooking time depend on the amount, the condition and the quality of the food.

Meat	Automatic Function	Temperature range	Total cooking time from signal (mins)
Frying with a small amount of oil function			
Escalope, plain or breaded	Frying sensor function	4	6 - 10
Fillet	Frying sensor function	4	6 - 10
Chop*	Frying sensor function	3	10 - 15
Cordon bleu, Wiener Schnitzel*	Frying sensor function	4	10 - 15
Steak, rare (3 cm thick)	Frying sensor function	5	6 - 8
Steak, medium or well-done (3 cm thick)	Frying sensor function	4	8 - 12
Poultry breast (2 cm thick)*	Frying sensor function	3	10 - 20
Sausages, pre-boiled or raw*	Frying sensor function	3	8 - 20
Hamburgers, meatballs, stuffed meat roulades*	Frying sensor function	3	6 - 30
Meat loaf	Frying sensor function	2	6 - 9
Ragoût, gyros	Frying sensor function	4	7 - 12
Minced meat	Frying sensor function	4	6 - 10
Bacon	Frying sensor function	2	5 - 8
Simmering function			
Sausages	Cooking sensor function	85 °C	10 - 20

* Turn several times.

** Heat the oil with the lid on. Fry in portions with the lid off (see table for cooking time per portion).

*** Add the food right at the beginning.

Meat	Automatic Function	Temperature range	Total cooking time from signal (mins)
Boiling function			
Meatballs	Cooking sensor function	100 °C	20 - 30
Stewing poultry	Cooking sensor function	100 °C	60 - 90
Viennese boiled beef	Cooking sensor function	100 °C	60 - 90

Cooking in a pressure cooker function

Chicken, veal***	Cooking sensor function	115 °C	15 - 25
------------------	-------------------------	--------	---------

Frying with a large amount of oil function

Chicken portions, meatballs**	Cooking sensor function	175 °C	10 - 15
-------------------------------	-------------------------	--------	---------

* Turn several times.

** Heat the oil with the lid on. Fry in portions with the lid off (see table for cooking time per portion).

*** Add the food right at the beginning.

Fish	Automatic Function	Temperature range	Total cooking time from signal (mins)
Frying with a small amount of oil function			
Fried whole fish, e.g. trout	Frying sensor function	3	10 - 20
Fish fillet, plain or breaded	Frying sensor function	3 - 4	10 - 20
Scampi, prawns	Frying sensor function	4	4 - 8

Simmering function

Stewing fish, e.g. hake	Cooking sensor function	90 °C	15 - 20
-------------------------	-------------------------	-------	---------

Frying with a large amount of oil function

Fish, beer-battered or breaded*	Cooking sensor function	175 °C	10 - 15
---------------------------------	-------------------------	--------	---------

* Heat the oil with the lid on. Fry one portion after the other with the lid off (the table shows the time required for each portion).

Egg-based dishes	Automatic function	Temperature range	Total cooking time from signal (mins)
Frying with a small amount of oil function			
Pancakes*	Frying sensor function	5	-
Omelette*	Frying sensor function	2	3 - 6
Fried eggs	Frying sensor function	2 - 4	2 - 6
Scrambled eggs	Frying sensor function	2	4 - 9
Kaiserschmarrn (shredded pancake)	Frying sensor function	3	10 - 15
French toast	Frying sensor function	3	4 - 8

Boiling function

Hard-boiled eggs**	Cooking sensor function	100 °C	5 - 10
--------------------	-------------------------	--------	--------

* Total time for each portion. Fry one after the other.

** Add the food right at the beginning.

Vegetables and pulses	Automatic function	Temperature range	Total cooking time from signal (mins)
Frying with a small amount of oil function			
Garlic, onions	Frying sensor function	1 - 2	2 - 10
Courgettes, aubergines	Frying sensor function	3	4 - 12
Peppers, green asparagus	Frying sensor function	3	4 - 15
Vegetables sautéed in oil, e.g. courgettes, green peppers	Frying sensor function	1	10 - 20
Mushrooms	Frying sensor function	4	10 - 15
Glazed vegetables	Frying sensor function	3	6 - 10
Boiling function			
Fresh vegetables, e.g. broccoli	Cooking sensor function	100 °C	10 - 20
Fresh vegetables, e.g. Brussels sprouts	Cooking sensor function	100 °C	30 - 40
Lentils, Chickpeas, Peas*	Cooking sensor function	100 °C	15 - 20
Stew*	Cooking sensor function	100 °C	45 - 60
Cooking in a pressure cooker function			
Vegetables, e.g. green beans	Cooking sensor function	115 °C	5 - 10
Chickpeas, beans	Cooking sensor function	115 °C	10 - 12
Lentil stew	Cooking sensor function	115 °C	15 - 20
Frying with a large amount of oil function			
Vegetables and mushrooms, breaded or beer-battered**	Cooking sensor function	175 °C	5 - 10

* Add the food right at the beginning.

** Heat the oil with the lid on. Fry one portion after the other with the lid off (the table shows the time required per portion).

Potatoes	Automatic function	Temperature range	Total cooking time from signal (mins)
Frying with a small amount of oil function			
Fried potatoes (made from potatoes boiled in their skins)	Frying sensor function	5	6 - 12
Fried potatoes (made from raw potatoes)	Frying sensor function	4	15 - 25
Potato fritter*	Frying sensor function	5	2,5 - 3,5
Swiss rösti	Frying sensor function	1	50 - 55
Glazed potatoes	Frying sensor function	3	15 - 20
Simmering function			
Potato dumplings	Cooking sensor function	85 °C	30 - 40
Boiling function			
Potatoes**	Cooking sensor function	100 °C	30 - 40

* Total time for each portion. Fry one after the other.

** Add the food right at the beginning.

Potatoes	Automatic function	Temperature range	Total cooking time from signal (mins)
Cooking in a pressure cooker function			
Potatoes**	Cooking sensor function	115 °C	10 - 12
* Total time for each portion. Fry one after the other. ** Add the food right at the beginning.			
Pasta and cereals			
Simmering function			
Rice	Cooking sensor function	85 °C	25 - 35
Polenta*	Cooking sensor function	85 °C	20 - 25
Semolina pudding	Cooking sensor function	85 °C	5 - 10
Boiling function			
Noodles	Cooking sensor function	100 °C	7 - 10
Stuffed pasta or dumplings	Cooking sensor function	100 °C	6 - 15
Cooking in a pressure cooker function			
Rice**	Cooking sensor function	115 °C	6 - 8
* Heat up with the lid on; cook with the lid off and stir frequently. ** Add the food right at the beginning.			
Soups			
Simmering function			
Instant soups, e.g. creamy soups*	Cooking sensor function	85 °C	10 - 15
Boiling function			
Homemade broths, e.g. meat or vegetable soups**	Cooking sensor function	100 °C	60 - 90
Instant soups, e.g. minestrone	Cooking sensor function	100 °C	5 - 10
Cooking in a pressure cooker function			
Homemade broths, e.g. vegetable soups**	Cooking sensor function	115 °C	20 - 30
* Stir frequently. ** Add the food right at the beginning.			
Sauces			
Frying with a small amount of oil function			
Tomato sauce with vegetables	Frying sensor function	1	25 - 35
Béchamel sauce	Frying sensor function	1	10 - 20
Cheese sauce, e.g. Gorgonzola sauce	Frying sensor function	1	10 - 20
Reducing sauces, e.g. tomato sauce, bolognese sauce	Frying sensor function	1	25 - 35
Sweet sauces, e.g. orange sauce	Frying sensor function	1	15 - 25

Desserts	Automatic function	Temperature range	Total cooking time from signal (mins)
Simmering function			
Rice pudding*	Cooking sensor function	85 °C	40 - 50
Porridge	Cooking sensor function	85 °C	10 - 15
Compote**	Cooking sensor function	85 °C	10 - 20
Chocolate pudding***	Cooking sensor function	85 °C	3 - 5

Frying with a large amount of oil function

Patisserie, e.g. ring or filled doughnuts****	Cooking sensor function	175 °C	5 - 10
---	-------------------------	--------	--------

* Stir frequently.

** Add the food right at the beginning.

*** Heat up with the lid on; cook with the lid off and stir frequently.

**** Heat the oil with the lid on. Fry one portion after the other with the lid off (the table shows the time required per portion).

Frozen products	Automatic function	Temperature range	Total cooking time from signal (mins)
Frying with a small amount of oil function			
Escalope	Frying sensor function	4	15 - 20
Cordon bleu*	Frying sensor function	4	10 - 30
Poultry breast*	Frying sensor function	4	10 - 30
Chicken nuggets	Frying sensor function	4	10 - 15
Gyros, kebab	Frying sensor function	3	5 - 10
Fish fillet, plain or breaded	Frying sensor function	3	10 - 20
Fish fingers	Frying sensor function	4	8 - 12
French fries	Frying sensor function	5	4 - 6
Stir fries, e.g. stir-fried vegetables with chicken	Frying sensor function	3	6 - 10
Spring rolls	Frying sensor function	4	10 - 30
Camembert/cheese	Frying sensor function	3	10 - 15

Heating/keep-warm function

Frozen vegetables in a creamy sauce, e.g. cream of spinach**	Cooking sensor function	70 °C	15 - 30
--	-------------------------	-------	---------

Boiling function

Frozen vegetables, e.g. green beans**	Cooking sensor function	100 °C	15 - 20
---------------------------------------	-------------------------	--------	---------

Frying with a large amount of oil function

Frozen chips***	Cooking sensor function	170 °C	4 - 8
-----------------	-------------------------	--------	-------

* Turn several times.

** Add liquid according to the manufacturer's instructions.

*** Heat the oil with the lid on. Fry in portions with the lid off (see table for cooking time per portion).

Further	Automatic function	Temperature range	Total cooking time from signal (mins)
Frying with a small amount of oil function			
Camembert/cheese	Frying sensor function	3	7 - 10
Precooked dry products that require water to be added, e.g. pasta	Frying sensor function	1	5 - 10
Croutons	Frying sensor function	3	6 - 10
Almonds/nuts/pine nuts	Frying sensor function	4	3 - 15
Heating/keep-warm function			
Food in jars and tins, e.g. goulash soup*	Cooking sensor function	70 °C	10 - 15
Mulled wine**	Cooking sensor function	70 °C	-
Simmering function			
Milk**	Cooking sensor function	85 °C	-

* Add the food right at the beginning and stir frequently.

** Add the food right at the beginning.

Preparation and maintenance of the wireless temperature sensor

In this section, you will find the following information:

- Adhering the silicone patch
- Using the wireless temperature sensor
- Cleaning
- Changing the battery

You can obtain a temperature sensor and silicone patches from specialist retailers or through our technical after-sales service. Always quote the relevant reference number:

CA060300	Temperature sensor and set of 5 silicone patches
-----------------	--

00577921	Set of 5 silicone patches
-----------------	---------------------------

Adhering the silicone patch

The silicone patch attaches the temperature sensor to the cookware.

If you are using a saucepan with the cooking sensor function for the first time, you must attach a silicone patch.

Proceed as follows:

- 1 The adhesion point on the saucepan must be free of grease. Clean the saucepan, dry it thoroughly and wipe the adhesion point with a degreasing agent such as alcohol.
- 2 Remove the protective film from the silicone patch. Adhere the silicone patch to the correct place on the saucepan using the enclosed template as a guide.

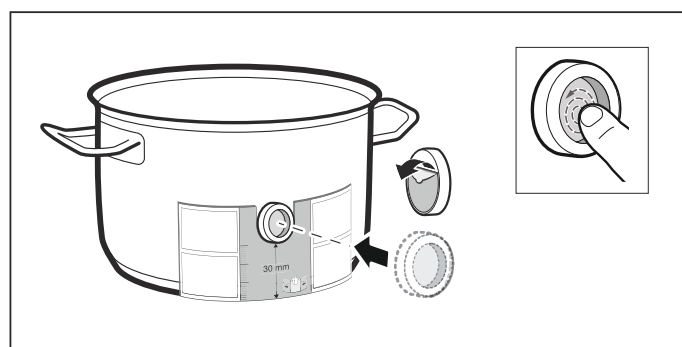

- 3 Press the silicone patch down, and press on its inside surface too. The adhesive requires one hour to fully harden. The cookware must not be used or cleaned during this time.

Notes

- Cookware with the silicone patch must not be left to soak in soapy water for long periods.
- If the silicone patch comes off, attach a new one.

Using the wireless temperature sensor

Attach the temperature sensor to the silicone patch and align it correctly.

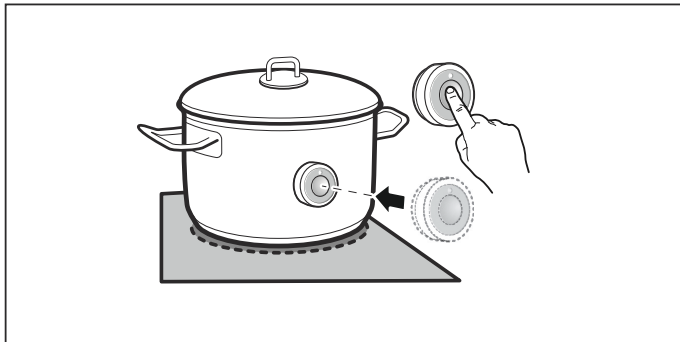

Notes

- You can use up to three temperature sensors at the same time.
- Make sure that the silicone path is completely dry before attaching the temperature sensor.
- Position the cookware in such a way that the temperature sensor is pointing towards the outer side of the hob.
- To prevent overheating, the temperature sensor must not be pointed towards another item of cookware that is hot.
- Remove the temperature sensor from the saucepan after cooking. Store it in a clean, safe place away from sources of heat.

Cleaning

Do not clean the wireless temperature sensor in the dishwasher

You can find information on cleaning the temperature sensor in the section on → "Cleaning"

Changing the battery

If you press the wireless temperature sensor symbol and the LED does not light up, the battery is flat.

Changing the battery:

- 1 Remove the silicone cover from the lower section of the casing. Use a screwdriver to unscrew the screws.

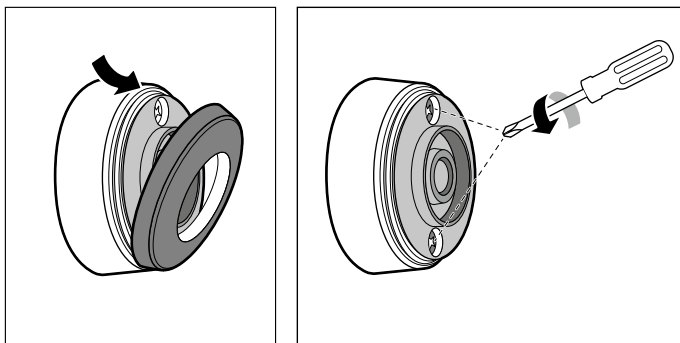

- 2 Remove the upper section of the casing. Remove the old battery. Insert the new battery. Make sure that the polarity is correct.

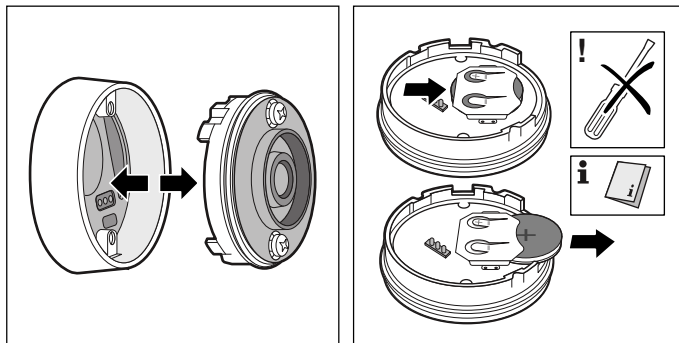

Caution!

Do not use metal objects to remove the battery. Do not touch the contacts.

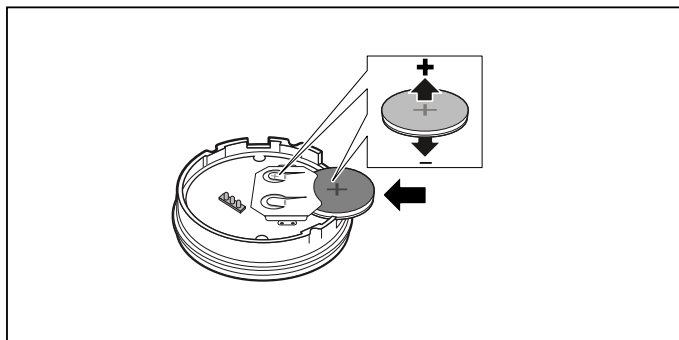

- 3 Put the upper and lower sections of the casing back together. Make sure that the contact pins are aligned correctly.

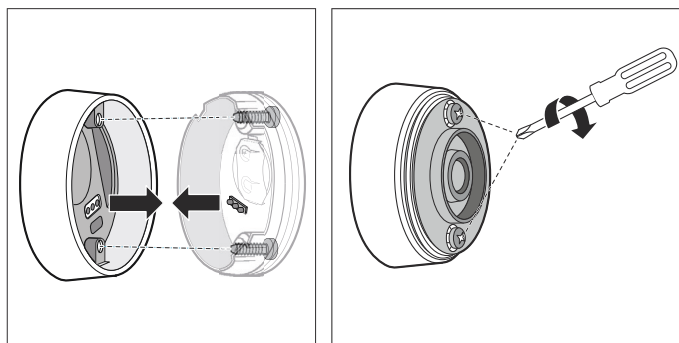

- 4 Put the silicone cover back on the lower section of the temperature sensor casing.

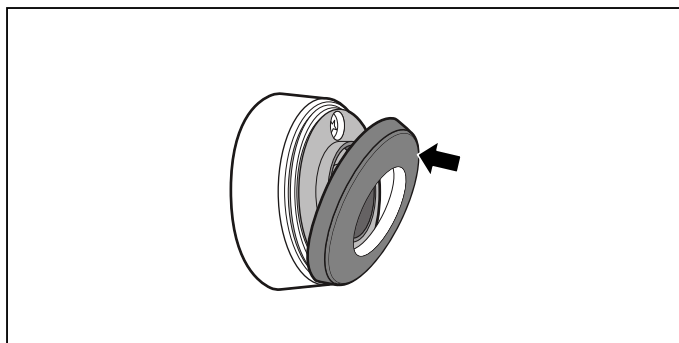

Note: Only use premium-quality CR2032 batteries. These have an especially long service life.

Declaration of Conformity

Gaggenau hereby declares that the appliance with wireless temperature sensor function meets the basic requirements and other relevant provisions of the Directive 1999/5/EG.

A detailed R&TTE Declaration of Conformity can be found online at www.gaggenau.com on the product page for your appliance under "Additional documents".

The logos and the Bluetooth® brand are registered trademarks and property of Bluetooth SIG, Inc. These trademarks are used by Gaggenau Hausgeräte GmbH under licence. All other trademarks and brand names are owned by the respective companies.

Childproof lock

The hob can be protected against being accidentally turned on, to ensure that children do not switch on the hotplates.

Activating and deactivating the childproof lock

The hob must be switched off.

To activate: Remove the twist knob from the hotplate. A signal sounds. The  indicator lights up for 10 seconds. The hob is locked.

To deactivate: Place the twist knob on the twistpad.

Note: Removing the twist knob when the hotplate is switched on initially activates the display cleaning protection function. If the twist knob is not put back on after 10 minutes, the hotplate switches itself off and the child lock is activated.

Display cleaning protection

If you wipe over the control panel while the hob is switched on, settings may be changed. To avoid this, the hob has a function you can use to lock the control panel for cleaning.

To activate: Remove the twist knob.

An audible signal sounds. The  indicator and the hob settings flash. The heating process is interrupted. If a cooking timer is set, it will be paused. The control panel is locked for 10 minutes.

You can now wipe over the surface of the control panel without altering the settings.

To deactivate: Put the twist knob back on within 10 minutes.

The control panel is unlocked. The hob continues operating with the previous settings.

To end the function early, put the twist knob back on before the 10 minutes have elapsed.

Automatic safety cut-out

If a hotplate operates for an extended period and no settings are changed, the automatic safety shut-off is activated.

The hotplate stops heating. A signal sounds and the residual heat indicator *h* or *H* appears in the hotplate display.

When you touch any symbol, the display switches off. The hotplate can now be set again.

The point at which the safety shut-off becomes active depends on which heat setting has been set (after 1 to 10 hours). .

Basic settings

Display	Function
	Signal tones
<i>c 1</i>	<i>00</i> All signals are switched on.* <i>0FF</i> Most of the signals are switched off.
	Time for selecting the hotplate
<i>c 2</i>	<i>5</i> The hotplate remains selected for 5 seconds. <i>10</i> The hotplate remains selected for 10 seconds.* <i>15</i> The hotplate remains selected for 15 seconds. <i>0FF</i> Unlimited: The hotplate which was set last remains selected.
	Power management function. Limiting the total power of the hob
<i>c 3</i>	<i>0</i> Off.* <i>1.0</i> 1000 W minimum power. <i>1.5</i> 1500 W. <i>2.0</i> 2000 W. ... <i>9.0</i> 9000 W. Maximum power of the hob.
	Restoring the factory settings
<i>c 4</i>	<i>0FF</i> Keep personal settings.* <i>00</i> Restore factory settings.
	Cooking sensor function
<i>c 5</i>	Connecting the wireless temperature sensor to the hob Set according to height above sea level: <i>1-2</i> Decreased <i>3</i> Basic setting <i>4-9</i> Increased
	Professional chef function.
<i>c 6</i>	Select individual hotplates to preset the heat setting for professional chef function. Preset values*: Left flexible zone: <i>5.0</i> Middle hotplate: <i>9.0</i> Right flexible zone: <i>1.5</i>
	Cookware, checking the result of the cooking process
<i>c 7</i>	<i>0</i> Not suitable <i>!</i> Not perfect <i>2</i> Suitable

*Factory setting

To access the basic settings:

The hob must be off.

- 1 Switch on the hob.
- 2 Touch the  symbol within the next 10 seconds.
The first four displays provide product information.
Turn the twist knob to view the individual displays.

Product information	Display screen
After-sales service index (ASSI)	01
Production number	Fd
Production number 1	95.
Production number 2	05

- 3 Touch the  symbol again to access the basic settings.
c 1 and 00 light up as a presetting in the displays.

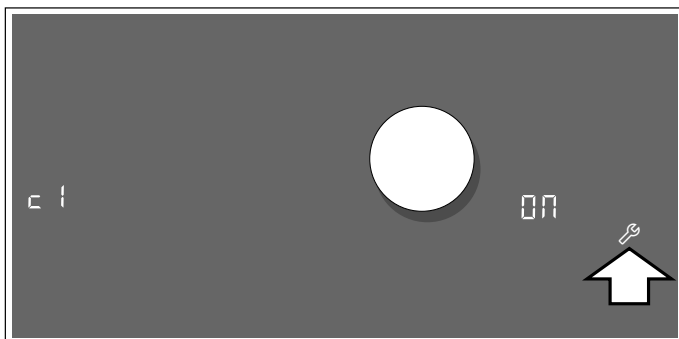

- 4 Touch the  symbol repeatedly until the required function is displayed.
- 5 Then use the twist knob to select the required setting.

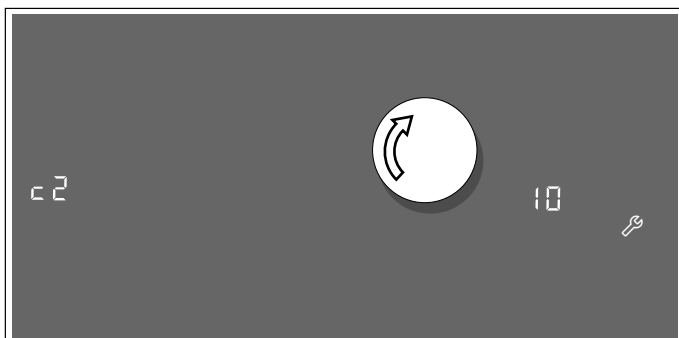

- 6 Touch the  symbol for at least 4 seconds.

The settings have been saved.

Leaving the basic settings

Turn off the hob with the main switch.

Suitability test of tableware

This function can be used to check the speed and quality of the cooking process depending on the cookware.

The result is a reference value and depends on the properties of the cookware and the hotplate being used.

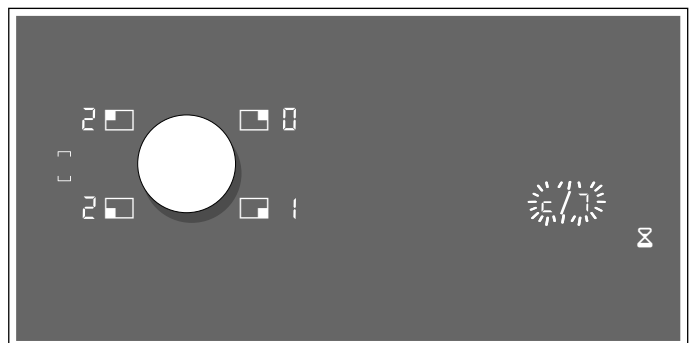

- 1 With the cookware still cold, fill it with approx. 200 ml of water and place it on the centre of the hotplate with the diameter that most closely matches that of the base of the cookware.
- 2 Go to the basic settings and select the c 7 setting.
- 3 Touch the control panel. — will flash on the hotplate display.
The function has now been activated.

After 10 seconds, the result for the quality and speed of the cooking process will appear in the hotplate display.



Check the result using the following table:

Result

- | | |
|---|--|
|  | The cookware is not suitable for the hotplate and will therefore not heat up.* |
|  | The cookware is taking longer to heat up than expected and the cooking process is not going as well as it should.* |
|  | The cookware is heating up correctly and the cooking process is going well. |

* If there is a smaller hotplate available, test the cookware again on the smaller hotplate.

To reactivate this function, touch the settings range.

Notes

- If the diameter of the hotplate used is much smaller than the diameter of the cookware, only the middle of the cookware can be expected to heat up. This may result in the cooking results not being as good as expected or being less than satisfactory.
- You can find information on this function in the section on → "Basic settings"
- You can find information on the type, size and positioning of the cookware in the section on → "Cooking with induction"

Cleaning

Suitable maintenance and cleaning products can be purchased from the after-sales service or in our e-Shop.

Hob

Cleaning

Always clean the hob after cooking. This will prevent food deposits from becoming burned on. Only clean the hob after the residual heat indicator has gone out.

Clean the hob with a damp dish cloth and dry it with a cloth or towel to prevent limescale build-up.

Only use cleaning agents that are suitable for this type of hob. Observe the manufacturer's instructions on the product packaging.

Never use:

- Undiluted washing-up liquid
- Cleaning agents designed for dishwashers
- Abrasive cleaners
- Harsh cleaning agents, such as oven spray and limescale remover
- Scouring pads
- High-pressure cleaners or steam jet cleaners

Stubborn dirt is best removed with a glass scraper, available from retailers. Observe the manufacturer's instructions.

You can obtain a suitable glass scraper from customer services or through our online shop.

Using a special sponge for cleaning glass-ceramic hobs achieves a great cleaning result.

Potential marks

Limescale and water marks	Clean the hob as soon as it has cooled down. You can use a cleaning agent suitable for glass-ceramic hobs.*
Sugar, rice starch or plastic	Clean immediately. Use a glass scraper. Caution: Risk of burns.*

* Then clean with a damp dish cloth and dry with a cloth or towel.

Note: Do not use any cleaning agents while the hob is still hot. This may mark the surface. Make sure that any residue left by cleaning agents is removed.

Hob surround

To prevent damage to the hob surround, observe the following instructions:

- Only use warm soapy water
- Wash new dish cloths thoroughly before use.
- Do not use harsh or abrasive cleaning agents.
- Do not use a glass scraper or sharp objects.

Twist knob

The twist knob is best cleaned using lukewarm soapy water. Do not use harsh or abrasive cleaning agents. Do not clean the twist knob in the dishwasher or using rinsing water. This may damage it.

Wireless temperature sensor

Temperature sensor

Clean the temperature sensor with a damp cloth. Never clean it in the dishwasher. Do not immerse it in water or clean it under running water.

Remove the temperature sensor from the saucepan after cooking. Store it in a clean, safe place (such as in its packaging) away from sources of heat.

Silicone patch

Clean and dry before attaching to the temperature sensor. Dishwasher safe.

Note: Cookware with the silicone patch must not be left to soak for long periods in soapy water.

Temperature sensor window

The sensor window must always be clean and dry. Proceed as follows:

- Remove dirt and oil splatters regularly.
- Use a soft cloth or cotton buds and window cleaner for cleaning.

Notes

- Do not use abrasive cleaning agents such as scouring pads, scrubbing brushes or cream cleaners.
- Do not touch the sensor window with your fingers. This may make it dirty or scratch it.

Frequently Asked Questions (FAQ)

Using the appliance

Why can't I switch on the hob and why is the childproof lock symbol lit up?

The childproof lock is activated. Place the twist knob on the twistpad.

You can find information on this function in section → "Suitability test of tableware"

Why can I hear an audible signal?

Remove any liquid or food remains from the control panel. Remove any objects from the control panel.

You can find instructions on how to deactivate the audible signal in the section on → "Basic settings"

Noises

Why I can hear noises while I'm cooking?

Noises may be generated while using the hob depending on the base material of the cookware. These noises are a normal part of induction technology. They do not indicate a defect.

Possible noises:

A low humming noise like the one a transformer makes:

Occurs when cooking at a high heat setting. The noise disappears or becomes quieter when the heat setting is reduced.

Low whistling noise:

Occurs when the cookware is empty. This noise disappears when water or food is added to the cookware.

Crackling:

Occurs when using cookware made from different layers of material or when using cookware of different sizes and different materials at the same time. The loudness of the noise can vary depending on the quantity of food being cooked or the cooking method.

High-pitched whistling noises:

Can occur when two hotplates are used at the highest heat setting at the same time. The whistling noises disappear or become quieter when the heat setting is reduced.

Fan noise:

The hob is equipped with a fan that switches on automatically at high temperatures. The fan may continue to run even after you have switched off the hob if the temperature detected is still too high.

Cookware

Which types of cookware can be used with the induction hob?

You can find information on which types of cookware can be used with an induction hob in section → "Cooking with induction".

Why is the hotplate not heating up and why is the heat setting flashing?

The hotplate on which the cookware is standing is not switched on.

Check that you have switched on the correct hotplate.

The cookware is too small for the hotplate that is switched on or it is not suitable for induction cooking.

Check that the cookware is suitable for induction cooking and that it is placed on the hotplate that best corresponds to its size. You can find information on the type, size and positioning of the cookware in the sections on → "Cooking with induction", → "Flex function" and → "Transfer function"

Cookware

Why is it taking so long for the cookware to heat up or why is it not heating up sufficiently despite being on a high heat setting?

The cookware is too small for the hotplate that is switched on or it is not suitable for induction cooking.

Check that the cookware is suitable for induction cooking and that it is placed on the hotplate that best corresponds to its size. You can find information on the type, size and positioning of the cookware in the sections on → "Cooking with induction", → "Flex function" and → "Transfer function"

Cleaning

How do I clean the hob?

Using a special glass-ceramic cleaning agent produces the best results. We advise against using harsh or abrasive cleaning agents, dishwasher detergent (concentrated) or scouring pads.

You can find more information on cleaning and caring for your hob in the section on → "Cleaning"

What to do in the event of a fault

Usually, faults are small matters that are easy to eliminate. Please read the information in the table before calling the after-sales service.

Display	Possible cause	Troubleshooting
None	The power supply has been disconnected. The device has not been connected as shown in the circuit diagram. Electronic fault.	Use other electrical devices to check whether a short-circuit has occurred in the power supply. Ensure that the device has been connected in accordance with the circuit diagram. If the fault cannot be rectified, inform the technical after-sales service.
An audible signal sounds	The control panel is damp or an object is covering it.	Dry the control panel or remove the object.
<i>F2/E8207</i>	The electronics have overheated and switched off the relevant hotplate.	Wait until the electronics have cooled down sufficiently. Then touch any symbol on the hob.
<i>F4/E8208</i>	The electronics have overheated and all the hotplates have been switched off.	
<i>F5</i> + heat setting and signal	There is a hot saucepan in the control panel area. There is a risk that the electronics will overheat.	Remove the saucepan. The fault display will go out shortly afterwards. You can continue cooking.
<i>F5</i> and signal	There is a hot saucepan in the control panel area. The hotplate has been switched off to protect the electronics.	Remove the saucepan. Wait a few seconds. Touch any control. If the fault indicator goes out, you can continue cooking.
<i>F1/F6</i>	The hotplate has overheated and switched itself off to protect the work surface.	Wait until the electronics have cooled down sufficiently and switch the hotplate on again.
<i>F8</i>	The hotplate has been operating continuously for an extended period.	The automatic safety switch-off function has been activated. See section → "Automatic safety cut-out"
<i>F9</i>	The flex function cannot be activated.	Check the fault indicator by touching any control. You can use the remaining hotplates to cook as usual. Contact the technical after-sales service.
<i>E8202</i>	The temperature sensor has overheated and the hotplate has been switched off.	Wait until the temperature sensor has cooled down sufficiently before activating the function again.
<i>E8203</i>	The temperature sensor has overheated and all the hotplates have been switched off.	If you are not using the temperature sensor, remove it from the cookware and store it far away from the other hotplates and sources of heat. Switch the hotplate back on.
<i>E8204</i>	The battery in the temperature sensor is flat.	Change the 3 V CR2032 battery. See section "Changing the battery".
<i>E8205</i>	The temperature sensor is disconnected.	Switch the function off and on again.
<i>E8206</i>	The temperature sensor is broken/faulty.	Contact the technical after-sales service.
The temperature sensor indicator is not lighting up	The temperature sensor is not reacting and the indicator is not lighting up.	Change the 3 V CR2032 battery. See section "Changing the battery". If this does not solve the problem, press and hold the symbol on the temperature sensor for eight seconds and then reconnect the temperature sensor to the hob. If the problem persists, contact the technical after-sales service.
The indicator on the temperature sensor flashes twice.	The battery in the temperature sensor has almost run out. You may be interrupted the next time you cook by the battery running out.	Change the 3 V CR2032 battery. See section "Changing the battery".

Do not place hot saucepans on the control panel.

Display	Possible cause	Troubleshooting
The indicator on the temperature sensor flashes three times.	The temperature sensor is disconnected.	Press and hold the symbol on the temperature sensor for eight seconds and then reconnect the temperature sensor to the hob.
<i>E9000</i> <i>E90 10</i>	The operating voltage is incorrect/outside of the normal operating range.	Contact your electricity provider.
<i>U400</i>	The hob is not connected properly	Disconnect the hob from the power supply. Ensure that it has been connected in accordance with the circuit diagram.
<i>dE</i>	The demo mode is activated	Disconnect the hob from the power supply. Wait 30 seconds and reconnect it. Touch any touch control in the next three minutes. The demo mode is deactivated.
Do not place hot saucepans on the control panel.		

Notes

- If *E* appears in the display, the sensor for the relevant hotplate must be pressed and held in order to read the fault code.
- If the fault code is not listed in the table, disconnect the hob from the power supply, wait 30 seconds and connect it again. If the display appears again, contact technical after-sales and tell them the precise fault code.

After-sales service

In the event of repairs please contact our after-sales service. We are committed to find the best solution also in order to avoid an unnecessary call-out.

Please quote the E number (product number) and the FD number (production number) of your appliance when contacting the after-sales service. The rating plate bearing these numbers can be found on the bottom of the appliance. For future reference you can note the data of your appliance and the telephone number of our after-sales service below.

E-Nr.	FD-Nr.
-------	--------

After-sales service 

Please note that calling out an after-sales service technician is not free of charge, even within the warranty period, should the problem result from an operating error.

Risk of electric shock!

Incorrect repairs are dangerous. Repairs may only be carried out by one of our trained after-sales engineers. If the appliance is faulty, unplug the mains plug or switch off the fuse in the fuse box. Contact the after-sales service.

Please find the contact data of all countries in the enclosed customer service list.

To book an engineer visit and product advice

GB 0344 892 8988
Calls charged at local or mobile rate.

IE 01450 2655
0.03 € per minute at peak.
Off peak 0.0088 € per minute.

AU 1300 368 339

NZ 09 477 0492

Trust the expertise of the manufacturer, and rest assured that the repair will be carried out by trained service technicians using original spare parts for your domestic appliance.

Gaggenau Hausgeräte GmbH
Carl-Wery-Straße 34
81739 München
GERMANY
www.gaggenau.com

GAGGENAU



9001063859 en (960218)