

BO 470/471 ..2

BO 480/481 ..2

Oven

Table of contents

Intended use	4	Automatic programmes	21
Important safety information	5	Information on the settings	21
Causes of damage	7	Selecting a dish	21
Environmental protection	7	Applying settings for a dish	21
Saving energy	7	Calling up the last automatic programmes used	22
Environmentally-friendly disposal	7	Individual recipes	22
Familiarising yourself with your appliance	8	Recording a recipe	22
Oven	8	Programming a recipe	23
Display and operating controls	9	Entering names	23
Symbols	9	Starting recipes	23
Colours and display	10	Change recipe	24
Automatic door opening	10	Deleting recipes	24
Standby	10	Core temperature probe	24
Activating the appliance	10	Inserting the core temperature probe into the food	24
Additional information i and i [®]	11	Setting the core temperature	25
Cooling fan	11	Suggested values for the core temperature	26
Function selector positions	12	Rotary spit	27
Accessories	14	Preparation	27
Special accessories	14	Switching on the rotisserie spit	27
Before using the appliance for the first time	15	Switching off the rotisserie spit	27
Setting the language	15	Roasting function	28
Setting the time format	15	Childproof lock	28
Setting the clock	15	Activate the child lock	28
Setting the date format	15	Deactivating the child lock	28
Setting the date	15	Home Connect	29
Setting the temperature unit	15	Setting up	29
Ending initial set-up	15	Remote Start	30
Heating up the oven	15	Home Connect settings	30
Cleaning accessories	15	Remote diagnostics	31
Operating the appliance	16	About data protection	31
Cooking compartment	16	Declaration of Conformity	31
Inserting accessories	16	Basic settings	32
Switching on	16	Cleaning and maintenance	34
Rapid heating	17	Cleaning agents	34
Safety shut-off	17	Removing the insert grids	35
Timer functions	17	Pyrolytic self-cleaning	35
Calling up the timer menu	17	Preparing pyrolytic self-cleaning	35
Timer	17	Starting pyrolytic self-cleaning	36
Stopwatch	18	Cleaning accessories with pyrolytic self-cleaning	36
Cooking time	18	What to do in the event of a fault	37
End of cooking time	19	Power cut	37
Long-term timer	20	Demo mode	37
Setting the long-term timer	20	Replacing the oven light bulb	37

After-sales service	38
E number and FD number	38
Tables and tips	39
Vegetables	40
Side dishes and meals	41
Fish	43
Meat	44
Poultry	47
Grilling and roasting	48
Baked items	49
Dough proving (leaving to rise)	54
Desserts	54
Defrosting	55
Preserving	56
Disinfecting	56
Drying	56
Baking stone	57
Roasting dish	58
Acrylamide in foodstuffs	59

Additional information on products, accessories, replacement parts and services can be found at www.gaggenau.com and in the online shop www.gaggenau.com/zz/store

Intended use

Read these instructions carefully. Only then will you be able to operate your appliance safely and correctly. Retain the instruction manual and installation instructions for future use or for subsequent owners.

This appliance is only intended to be fully fitted in a kitchen. Observe the special installation instructions.

Check the appliance for damage after unpacking it. Do not connect the appliance if it has been damaged in transport.

Only a licensed professional may connect appliances without plugs. Damage caused by incorrect connection is not covered under warranty.

This appliance is intended for domestic use only. The appliance must only be used for the preparation of food and drink. The appliance must be supervised during operation. Only use this appliance indoors.

This appliance is intended for use up to a maximum height of 2000 metres above sea level.

This appliance may be used by children over the age of 8 years old and by persons with reduced physical, sensory or mental capabilities or by persons with a lack of experience or knowledge if they are supervised or are instructed by a person responsible for their safety how to use the appliance safely and have understood the associated hazards.

Children must not play with, on, or around the appliance. Children must not clean the appliance or carry out general maintenance unless they are at least 15 years old and are being supervised.

Keep children below the age of 8 years old at a safe distance from the appliance and power cable.

Always slide accessories into the cooking compartment correctly. See description of accessories in the instruction manual.

⚠ Important safety information

⚠ Warning – Risk of fire!

- Combustible items stored in the cooking compartment may catch fire. Never store combustible items in the cooking compartment. Never open the appliance door if there is smoke inside. Switch off the appliance and unplug it from the mains or switch off the circuit breaker in the fuse box.
- A draught is created when the appliance door is opened. Greaseproof paper may come into contact with the heating element and catch fire. Do not place greaseproof paper loosely over accessories during preheating. Always weight down the greaseproof paper with a dish or a baking tin. Only cover the surface required with greaseproof paper. Greaseproof paper must not protrude over the accessories.

⚠ Warning – Risk of burns!

- The appliance becomes very hot. Never touch the interior surfaces of the cooking compartment or the heating elements. Always allow the appliance to cool down. Keep children at a safe distance.
- The inside of the appliance door becomes very hot during operation. Always open the appliance door as far as it will go. Ensure that the appliance door does not swing back. Avoid contact with the inside of the appliance door.
- Accessories and ovenware become very hot. Always use oven gloves to remove accessories or ovenware from the cooking compartment.
- Alcoholic vapours may catch fire in the hot cooking compartment. Never prepare food containing large quantities of drinks with a high alcohol content. Only use small quantities of drinks with a high alcohol content. Open the appliance door with care.

- Bulbs become very hot when switched on. There is still a risk of burning for some time after they have been switched off. Allow the bulbs to cool down before cleaning the appliance. Switch off appliance light during cleaning.
- Bulbs become very hot when switched on. There is still a risk of burning for some time after they have been switched off. Allow the bulbs to cool down before replacing them.

⚠ Warning – Risk of scalding!

- The accessible parts become hot during operation. Never touch the hot parts. Keep children at a safe distance.
- When you open the appliance door, hot steam may escape. Open the appliance door with care. Keep children at a safe distance.
- Water in a hot cooking compartment may create hot steam. Never pour water into the cooking compartment when the cooking compartment is hot.

⚠ Warning – Risk of injury!

Scratched glass in the appliance door may develop into a crack. Do not use a glass scraper, sharp or abrasive cleaning aids or detergents.

⚠ Warning – Risk of electric shock!

- Incorrect repairs are dangerous. Repairs may only be carried out and damaged power cables replaced by one of our trained after-sales technicians. If the appliance is defective, unplug the appliance from the mains or switch off the circuit breaker in the fuse box. Contact the after-sales service.
- The cable insulation on electrical appliances may melt when touching hot parts of the appliance. Never bring electrical appliance cables into contact with hot parts of the appliance.

- Do not use any high-pressure cleaners or steam cleaners, which can result in an electric shock.
- When replacing the cooking compartment bulb, the bulb socket contacts are live. Before replacing the bulb, unplug the appliance from the mains or switch off the circuit breaker in the fuse box.
- A defective appliance may cause electric shock. Never switch on a defective appliance. Unplug the appliance from the mains or switch off the circuit breaker in the fuse box. Contact the after-sales service.
- The insulation of an incompatible meat probe may be damaged. Only use the meat probe which is recommended for this appliance.

⚠ Warning – Risk of fire!

- Loose food residues, grease and meat juices may catch fire during pyrolytic cleaning. Remove coarse dirt from the cooking compartment and from the accessories before every pyrolytic cleaning cycle.
- The appliance will become very hot on the outside during the pyrolytic cleaning cycle. Never hang combustible objects, e.g. tea towels, on the door handle. Do not place anything against the front of the oven. Keep children at a safe distance.

⚠ Warning – Risk of burns!

- The cooking compartment will become very hot during the pyrolytic cleaning cycle. Never open the appliance door or move the locking latch by hand. Allow the appliance to cool down. Keep children at a safe distance.
-  The appliance will become very hot on the outside during the Self-cleaning cycle. Never touch the appliance door. Allow the appliance to cool down. Keep children at a safe distance.

⚠ Warning – Risk of serious damage to health!

The appliance will become very hot during the pyrolytic cleaning cycle. The non-stick coating on baking trays and tins is destroyed and noxious gases are released. Never let non-stick baking trays and tins go through the pyrolytic cleaning cycle. Only enamelled accessories may be cleaned at the same time.

Causes of damage

Caution!

- Accessories, foil, greaseproof paper or ovenware on the cooking compartment floor: Do not place accessories on the cooking compartment floor. Do not cover the cooking compartment floor with any sort of foil or greaseproof paper. Do not place ovenware on the cooking compartment floor. This will cause heat to accumulate. The baking and roasting times will no longer be correct and the enamel will be damaged.
- Water in a hot cooking compartment: do not pour water into the cooking compartment when it is hot. This will cause steam. The temperature change can cause damage to the enamel.
- Moist food: do not store moist food in the cooking compartment when it is closed for prolonged periods. This will damage the enamel.
- Fruit juice: when baking particularly juicy fruit pies, do not pack the baking tray too generously. Fruit juice dripping from the baking tray leaves stains that cannot be removed. If possible, use the deeper universal pan.
- Cooling with the appliance door open: only allow the cooking compartment to cool when it is closed. Even if the appliance door is only open a little, front panels of adjacent units could be damaged over time.
- Very dirty door seal: If the door seal is very dirty, the appliance door will no longer close properly when the appliance is in use. The fronts of adjacent units could be damaged. Always keep the door seal clean.
- Appliance door as a seat, shelf or worktop: Do not sit on the appliance door, or place or hang anything on it. Do not place any cookware or accessories on the appliance door.
- Inserting accessories: depending on the appliance model, accessories can scratch the door panel when closing the appliance door. Always insert the accessories into the cooking compartment as far as they will go.
- Carrying the appliance: do not carry or hold the appliance by the door handle. The door handle cannot support the weight of the appliance and could break.

Environmental protection

The sections below list a number of energy-saving tips and provide information on disposing of your appliance.

Saving energy

- Use dark-coloured, black-coated or enamelled baking tins. These absorb the heat particularly well.
- Open the appliance door as little as possible during operation.
- If you are baking more than one cake, it is best to bake them one after the other. The fact that the oven is still warm will reduce the baking time for the second cake. You can also place two loaf tins next to each other.
- In hot air mode, you can bake on more than one level at a time.
- If the cooking time is relatively long, you can switch the appliance off 10 minutes before the cooking time ends and use the residual heat to finish cooking.

Environmentally-friendly disposal

Dispose of packaging in an environmentally-friendly manner.



This appliance is labelled in accordance with European Directive 2012/19/EU concerning used electrical and electronic appliances (waste electrical and electronic equipment - WEEE). The guideline determines the framework for the return and recycling of used appliances as applicable throughout the EU.

Familiarising yourself with your appliance

Use this section to familiarise yourself with your new appliance. The control panel and the individual operating controls are explained. You will find information on the cooking compartment and the accessories.

Oven

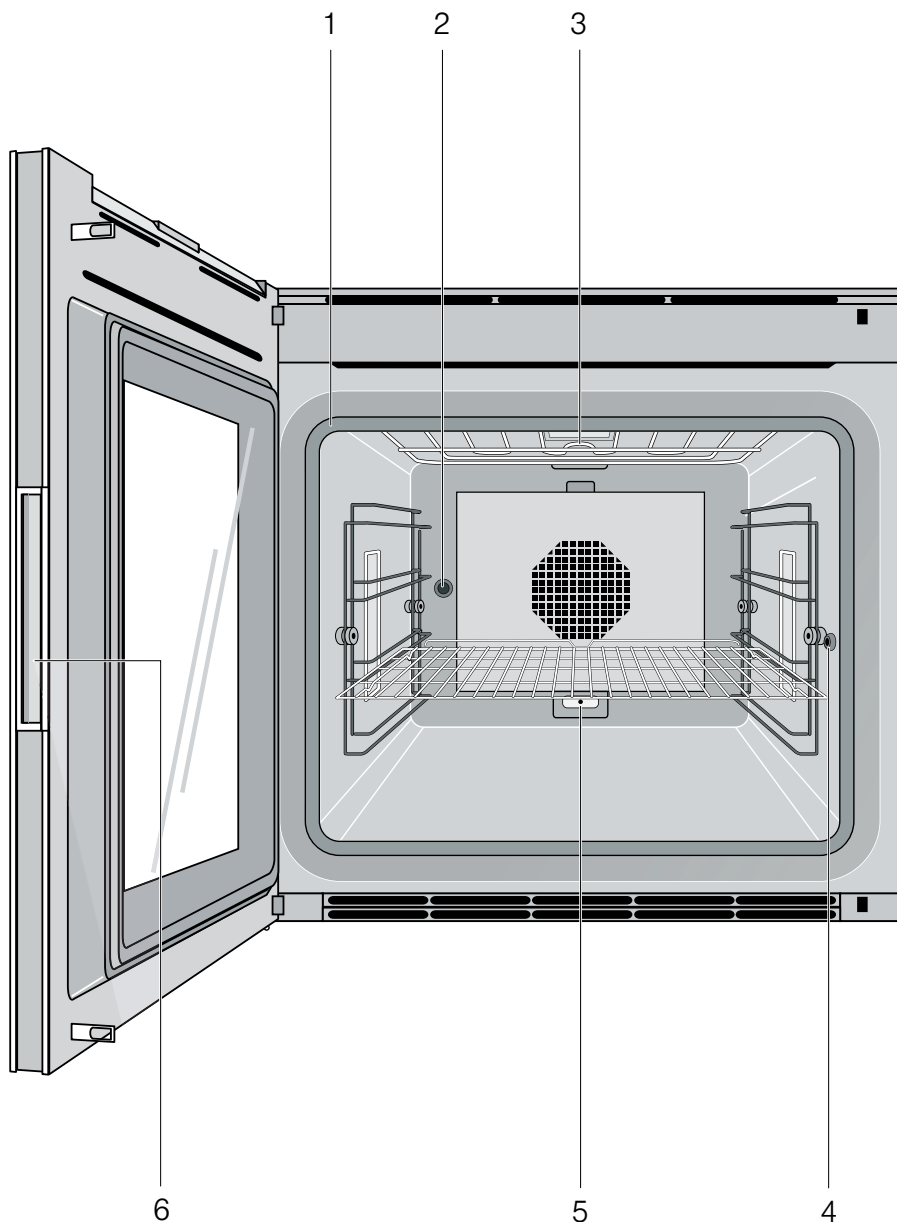

1	Door seal
2	Rotary spit drive
3	Grill element
4	Opening for core temperature probe

5	Opening for additional heating element (optional accessory for the baking stone and roaster)
6	Recessed handle

Display and operating controls

These instructions are valid for different versions of the appliance. There may be minor differences depending on the appliance model.

All versions of the appliance are operated in an identical manner.

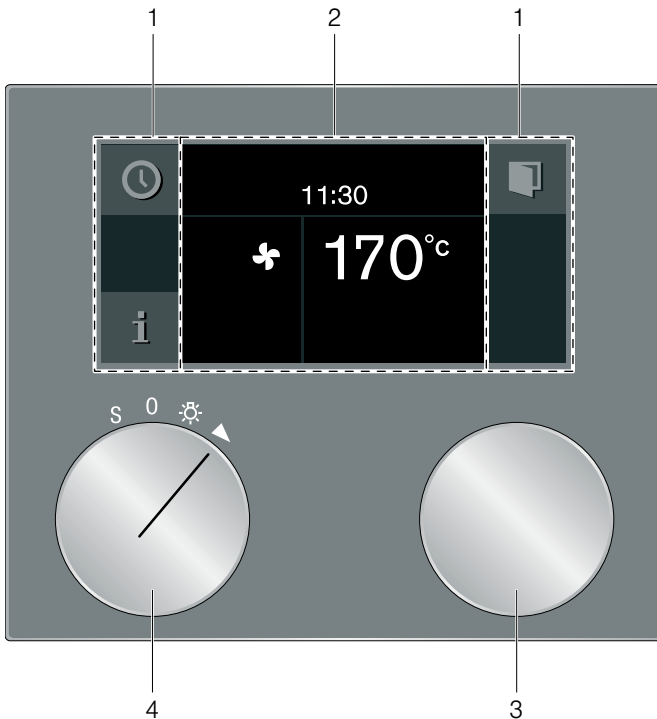

1	Control panel	These areas are touch sensitive. Touch a symbol to select the corresponding function.
2	Display	The display shows, for example, current settings and options.
3	Rotary selector	You can use the rotary selector to set the temperature and to make further settings.
4	Function selector	The function selector is used to select the type of heating, the cleaning function or the basic settings.

Symbols

Symbol	Function
▶	Start
■	Stop
	Pause/End
X	Cancel
C	Delete
✓	Confirm/save settings
>	Selection arrow
🚪	Open appliance door
i	Call up additional information
»	Rapid heating with status indicator
🍷	Calling up automatic programmes or individual recipes
rec	Record menu
↘	Edit settings
>A ^A	Enter name
✕	Delete letters
🔒	Child lock
🕒	Call up timer menu
🕒	Call up long-term timer
🚫	Demo mode
🍖	Call up core temperature probe
🍖	Start rotisserie spit
🍖	Stop rotisserie spit
»	Start roasting function
»	End roasting function
📶	Network connection (Home Connect)

Colours and display

Colours

The different colours are used to guide the user in the relevant setting situations.

Orange	Initial settings Main functions
Blue	Basic settings Cleaning
White	Values which can be set

Appearance

Depending on the situation, the appearance of symbols, values or the entire display changes.

Zoom	The setting that you are changing will appear larger on the display. If you have set a time and it is about to run out, it will appear larger on the display just before it runs out (e.g. 60 seconds before the end, if you have set the timer).
Pared-down display	After a short while, the amount of information shown on the display will be reduced and only the most important information will remain. This function is pre-set and can be changed in the basic settings.

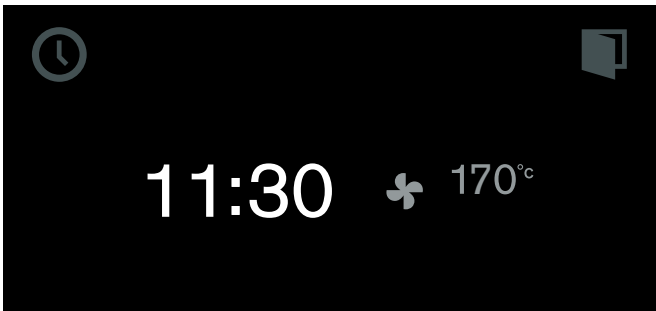

Automatic door opening

The appliance door springs open when you touch the  symbol and you can open it fully by using the recessed handle on the side.

Automatic door opening does not work if the child lock is activated or there is a power cut. You can open the recessed handle on the side by hand.

Standby

The appliance switches to standby mode if no function is set or the childproof lock is activated.

The brightness of the control panel is dimmed in standby mode.

Notes

- Different things can be displayed in standby mode. The default setting is the GAGGENAU logo and the time.
- The brightness of the display depends on the vertical viewing angle.
- You can change the display and the brightness at any time in the basic settings. → *"Basic settings" on page 32*

Activating the appliance

To exit standby mode, you can either

- Turn the function selector,
- Touch a control panel,
- Open or close the door.

You can now set the desired function. You can read about how to set functions in the respective chapters.

Notes

- When "Standby screen = off" is selected in the basic settings, you must turn the function selector to exit standby mode.
- The appliance returns to the standby screen if you have not made any settings for a long time after activation.
- When the door is open, the interior lighting switches off after a short time.

Additional information **i** and **i**[!]

By touching the **i** symbol, you can call up additional information. For example, information on the type of heating set or on the current temperature of the cooking compartment.

Note: During continuous operation after heating up, slight deviations in temperature are normal.

The **i**[!] symbol appears for important information and indicates that an action is required. Important information on safety and operating status is also occasionally displayed automatically. These messages disappear automatically after a few seconds or must be confirmed with .

With Home Connect messages, the Home Connect status additionally appears in the **i**[!]. You will find more information about this in the section entitled → "*Home Connect*" on page 29.

Cooling fan

Your appliance has a cooling fan. The cooling fan switches on during operation. Depending on the appliance version, the hot air escapes above or under the door.

After removing cooked food, keep the door closed until the appliance cools down. The appliance door must not be left ajar, as adjoining kitchen furniture may be damaged. The cooling fan continues to run for a certain time after operation and then switches off automatically.

Caution!





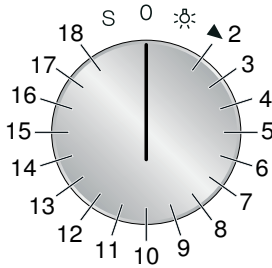



Do not cover the ventilation slots. Otherwise, the appliance will overheat.

Function selector positions



Position	Function/type of heating	Temperature	Application
0	"Off" position		
☀	Light		Switch on the interior lighting. Access to other functions, e.g. automatic programmes, individual recipes, remote start (Home Connect).
2	Hot air	50–300 °C Default temperature 170 °C	Hot air: For cakes, biscuits and bakes on more than one level. The fan in the back wall of the oven distributes the heat evenly throughout the cooking compartment.
3	Eco hot air*	50–300 °C Default temperature 170 °C	Energy-saving hot air mode for cakes, meat, bakes and gratins. Residual heat is optimally used. Convenience functions remain switched off (e.g. the interior lighting). The interior temperature can only be displayed while the appliance is heating up. Do not pre-heat the oven. Make sure that the cooking compartment is cold and that there is nothing already in there when you place the food inside. Then start the specified cooking time. Always keep the appliance door closed when cooking. This prevents heat loss.
4	Top + bottom heat	50–300 °C Default temperature 170 °C	For cakes in tins or on a baking tray, bakes, roasts.
5	Top + 1/3 bottom heat	50–300 °C Default temperature 170 °C	For tray bakes, biscuits, cakes with meringue, grilling and browning bakes. Ideally suited to heating the food specifically from above once again towards the end of preparation.
6	Top heat	50–300 °C Default temperature 170 °C	Targeted heat from above, for example grilling fruit flan with meringue.
7	1/3 Top + bottom heat	50–300 °C Default temperature 170 °C	For cheesecake, bread in loaf tins, dishes in a bain marie (e.g. egg custard and crème brûlée). For braising without a lid and warming up food (food dries out less). Ideally suited to heating the food specifically from below once again towards the end of preparation.
8	Bottom heat	50–300 °C Default temperature 170 °C	For adding extra baking time (such as for moist fruit flans), for boiling down, for dishes in a bain marie.
9	Hot air + bottom heat	50–300 °C Default temperature 170 °C	Additional heat from below for moist cakes, e.g. fruit flans.
10	Hot air + 1/3 bottom heat	50–300 °C Default temperature 170 °C	For deep bakes, lasagne, onion tart, egg dishes (e.g. tortilla and farmer's omelettes).
11	Full surface grill + air recirculation	50–300 °C Default temperature 220 °C	Even, all-round heating for meat, poultry and whole fish.

* Type of heating used to determine the energy efficiency class in accordance with EN 60350-1.

Position	Function/type of heating	Temperature	Application
12	 Full surface grill	50–300 °C Default temperature 220 °C	For grilling flat pieces of meat, sausages or fillets of fish. Grilling and browning.
13	 Compact grill	50–300 °C Default temperature 220 °C	Only the centre part of the grill heating element is heated. Energy-saving grilling for small amounts of food.
14	 Baking stone function	50–300 °C Default temperature 250 °C	Can only be used with the baking stone and heating element – these are optional accessories. Baking stone heated from below for crisp stone-baked pizza, bread or bread rolls.
15	 Roaster function	50–220 °C Default temperature 180 °C	Can only be used with the roaster, pull-out system and heating element (optional accessories). Heatable cast iron roaster for large joints of meat, bakes or festive roasts.
16	 Dough proving	30–50 °C Default temperature 38 °C	Proving: For yeast dough and sourdough. The dough rises considerably more quickly than at room temperature. The optimum temperature setting for yeast dough is 38 °C.
17	 Defrosting	40–60 °C Default temperature 45 °C	Even, gentle defrosting. For vegetables, meat, fish and fruit.
18	 Keeping warm	30–120 °C Default temperature 70 °C	Keeping food warm, pre-heating porcelain cookware.
S	 Basic settings		Your appliance can be adjusted to your requirements in the basic settings.
	 Pyrolytic self-cleaning	485 °C	Self-cleaning
* Type of heating used to determine the energy efficiency class in accordance with EN 60350-1.			

Accessories

Use only the accessories supplied with the product or available from the after-sales service. They are specially designed for your appliance. Ensure that you always insert the accessories into the cooking compartment the right way round.

Your appliance is equipped with the following accessories:

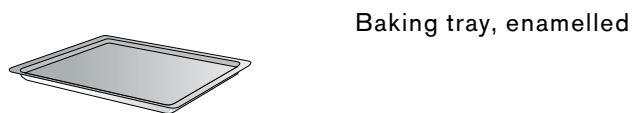

Baking tray, enamelled



Wire rack



Grill tray with wire rack

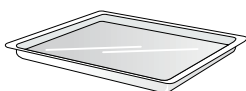

Glass tray (only with ovens 60 cm wide)



Rotisserie spit

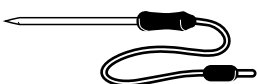

Plug-in core temperature probe

Special accessories

You can order the following special accessories from your specialist dealer:

BO 470/471

- BA 016 105 Pull-out system
Fully extendable telescopic pull-out rack and pyrolysis-proof cast frame
- BA 026 105 Grill tray, enamelled, 30 mm deep
- BA 026 115 Baking tray, enamelled 15 mm deep
- BA 036 105 Wire rack, chrome-plated, without opening, with feet
- BA 046 115 Glass dish, 24 mm deep
- BA 056 115 Heating element for baking stone and roaster (230 V)

- BA 056 125 Heating element for baking stone and roaster (400 V)
- BA 056 133 Baking stone
Including baking stone support and pizza paddle (order heating element separately)
- BS 020 002 Pizza paddle, set of 2
- GN 340 230 GN 2/3 cast aluminium roaster, height 165 mm, non-stick
(Order heating element and pull-out system separately)

BO 480/481

- BA 018 105 Pull-out system
Fully extendable telescopic pull-out rack and pyrolysis-proof cast frame
- BA 028 115 Baking tray, enamelled, 30 mm deep
- BA 038 105 Wire rack, chromium-plated, without opening, with feet
- BA 058 115 Heating element for baking stone and roaster
- BA 058 133 Baking stone
Including baking stone support and pizza paddle (order heating element separately)
- BS 020 002 Pizza paddle, set of 2
- GN 340 230 GN 2/3 cast aluminium roaster, height 165 mm, non-stick
(Order heating element and pull-out system separately)

Only use the accessories as specified. The manufacturer accepts no liability if these accessories are used incorrectly.

Remove any accessories that are not required during operation from the cooking compartment. Bush for the additional heating element at the back of the cooking compartment: Always leave the cover in during normal operation without the additional heating element.

Before using the appliance for the first time

In this section, you can find out what you must do before using your appliance to prepare food for the first time. First read the section entitled → *"Important safety information"* on page 5.

The appliance must be fully installed and connected to the mains.

After connecting the appliance to the power supply, the "Initial settings" menu will be displayed. Now you can now configure your new appliance for initial set-up.

Notes

- The "Initial settings" menu will appear only after the appliance has been connected to a power supply and switched on for the first time, or if the appliance has not been connected to a power supply for a number of days. Once the appliance has been connected to a power supply, the GAGGENAU logo will appear first for approximately 30 seconds. The "Initial settings" menu will then appear automatically.
- You can change the settings at any time in the basic settings. → *"Basic settings"* on page 32

Setting the language

The preset language appears in the display.

- 1 Turn the rotary selector to select the required display language.
- 2 Confirm with ✓.

Setting the time format

The two possible formats 24h and AM/PM appear in the display. The default is the 24h format.

- 1 Use the rotary selector to select the desired format.
- 2 Confirm with ✓.

Setting the clock

The time is shown in the display.

- 1 Set the desired time using the rotary selector.
- 2 Confirm with ✓.

Setting the date format

The three possible formats D.M.Y, D/M/Y and M/D/Y appear in the display. The default is the D.M.Y format.

- 1 Use the rotary selector to select the desired format.
- 2 Confirm with ✓.

Setting the date

The preset date appears in the display. The day setting is already active.

- 1 Set the day using the rotary selector.
- 2 Touch the > symbol to switch to the month setting.
- 3 Set the month using the rotary selector.
- 4 Touch the > symbol to switch to the year setting.
- 5 Set the year using the rotary selector.
- 6 Confirm with ✓.

Setting the temperature unit

The two possible units °C and °F will appear on the display. The default unit is °C.

- 1 Use the rotary selector to select the unit you require.
- 2 Confirm with ✓.

Ending initial set-up

"Initial set-up complete" will appear on the display.

Confirm with ✓.

The appliance will switch to standby mode and the standby display will appear. The appliance is now ready to use.

Heating up the oven

Make sure that there is no leftover packaging in the cooking compartment.

To eliminate the new-appliance smell, heat up the oven with it empty and the door closed. One hour with hot air 🔥 at 200 °C is ideal for this.

Cleaning accessories

Before using the accessories for the first time, clean them thoroughly using hot detergent solution and a soft cloth.

Operating the appliance

Cooking compartment

Depending on the oven version, the cooking compartment has four or five shelf levels. The shelf levels are counted from the bottom up.

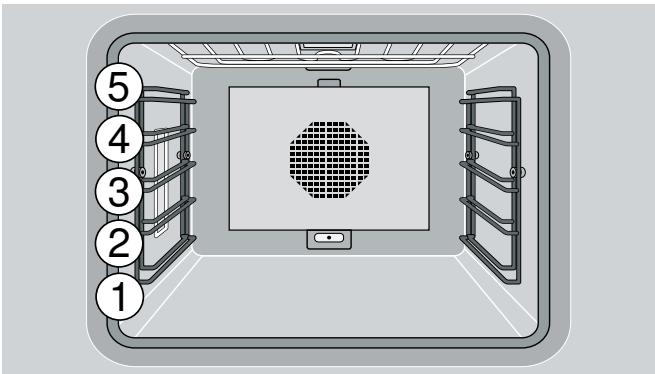
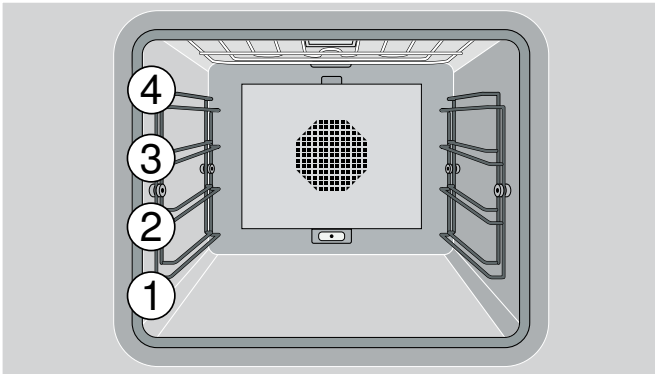

Caution!

- Do not place anything on the cooking compartment floor. Do not cover it with aluminium foil. A build-up of heat could damage the appliance.
- Do not slide any accessories between the shelf positions, or they may tip.

Inserting accessories

The accessories have a locking function. The locking function prevents the accessories from tilting when they are pulled out. The accessories must be inserted into the cooking compartment correctly for the tilt protection to work properly.

When inserting the wire rack, make sure that

- the lug **A** is pointing downwards
- the safety bar **B** on the wire rack is at the back and on top.

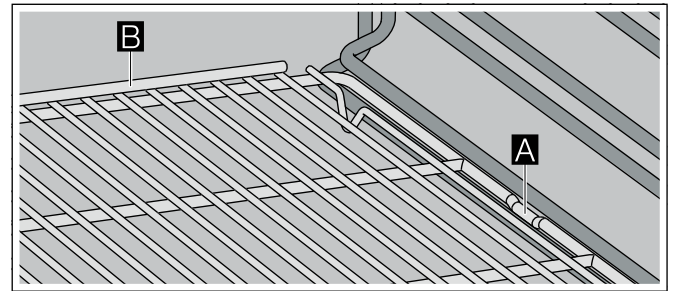

Switching on

- 1 Set the required heating mode using the function selector. The chosen heating mode and the default temperature are displayed.
- 2 If you want to change the default temperature: set the required temperature with the rotary selector.

The preheating symbol \gg appears on the display. The bar continuously shows the preheating status. When the set temperature is reached, a signal sounds and the preheating symbol \gg goes off.

Note: The oven interior lighting stays switched off at a temperature setting below 70°C



Switching off:

Turn the function selector to **0**.

Rapid heating

With the "Rapid heating" function, your appliance reaches the temperature you require particularly quickly in the "top heat", "bottom heat" and "top+ bottom heat" types of heating.

To ensure an even cooking result, do not place your food in the cooking compartment until "Rapid heating" is complete and the heat-up symbol  has gone out.

Note: The "Rapid heating" function is preconfigured in the factory settings. You can select "Rapid heating"  or "Heat-up"  in the basic settings. → "Basic settings" on page 32

Safety shut-off

For your protection, the appliance is equipped with an automatic safety shut-off. Any heating process is switched off after 12 hours if the oven is not operated in this time. A message appears in the display.

Exception:

The long-term timer has been programmed.

Set the function selector to **0**, then the appliance can be operated again as usual.

Timer functions

You use the timer menu to make the following settings:

 Short-term timer

 Stopwatch

 Cooking time (not in standby mode)

 Cooking time end (not in standby mode)

Calling up the timer menu

You can call up the timer menu from any mode. Only from the basic settings, function selector is set to **S**, the timer menu is not available.

Touch the  symbol.

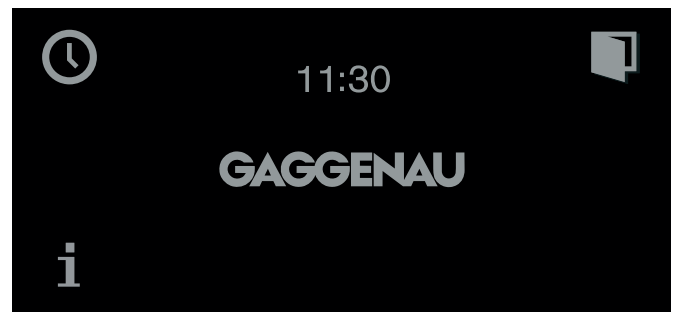

The timer menu is displayed.

Timer

The timer runs independently of the other appliance functions. You can enter a maximum of 90 minutes.

Setting the timer

- 1 Call up timer menu.
The "Timer"  function is displayed.
- 2 Turn the rotary selector to set the required cooking time.

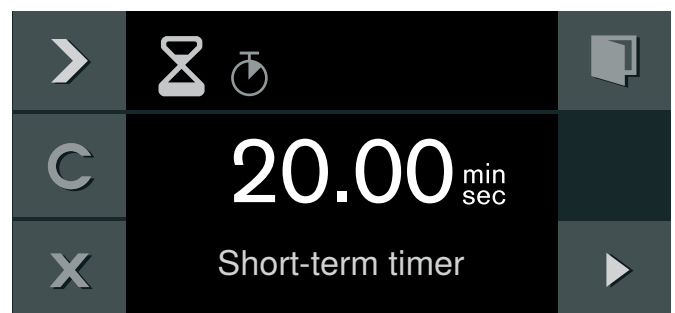

- 3 Start with .

The timer menu closes and the time begins to count down. The ⌚ symbol and the countdown appear in the display.

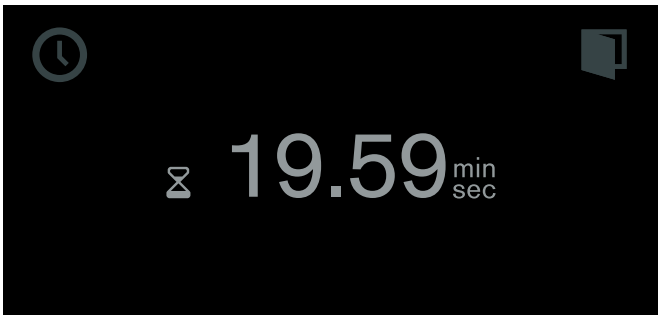

A signal sounds once the time has elapsed. Touch the ✓ symbol to silence.

You can exit the timer menu at any time by touching the ✕ symbol. This erases the settings.

To stop the timer:

Call up timer menu. Touch ▶ to select the "Timer" ⌚ function and touch the || symbol. To allow the timer to continue counting down, touch the ▶ symbol.

Switching off the timer early:

Call up timer menu. Touch ▶ to select the "Timer" ⌚ function and touch the C symbol.

Stopwatch

The stopwatch runs independently of the other appliance functions.

The stopwatch counts from 0 seconds up to 90 minutes.

It also has a pause function, which enables you to temporarily stop the clock.

Starting the stopwatch

- 1 Call up the "Timer" menu.
- 2 Touch ▶ to select the ⌚ "Stopwatch" function.

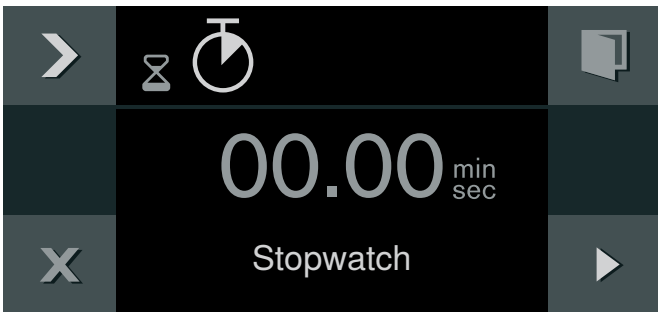

- 3 Press ▶ to start.

The "Timer" menu is closed and the time starts counting down. The ⌚ symbol and the elapsed time are shown in the display.

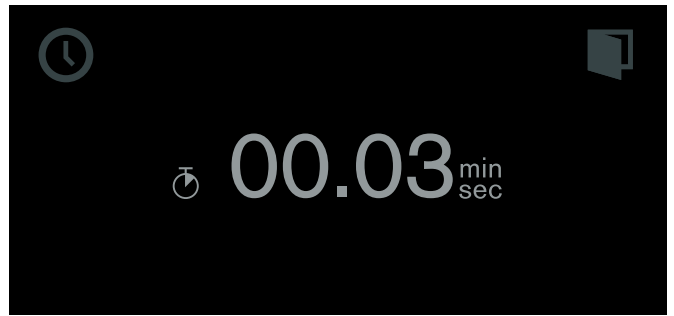

Pausing and restarting the stopwatch

- 1 Call up the "Timer" menu.
- 2 Touch ▶ to select the ⌚ "Stopwatch" function.
- 3 Touch the || symbol.

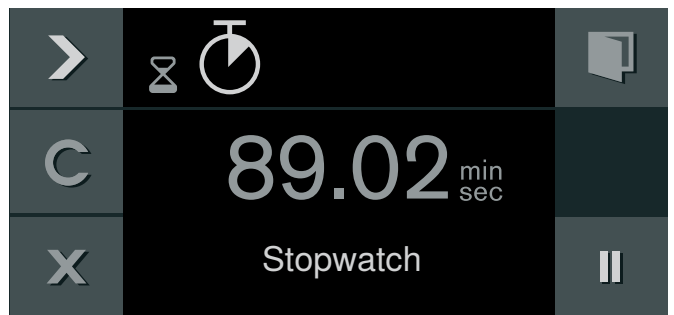

The time stops. The symbol changes to ▶ "Start".

- 4 Press ▶ to start.

The time continues to run. When 90 minutes is reached, the display pulsates and a signal sounds. The signal stops when you touch the ✓ symbol. The ⌚ symbol in the display goes out. The process has finished.

To switch off the stopwatch:

Call up the "Timer" menu. Touch ▶ to select the ⌚ "Stopwatch" function and touch the C symbol.

Cooking time

If you set a cooking time for your meal, the appliance switches off heating automatically after the selected time.

You can set a cooking time from 1 minute to 23 hours 59 minutes.

Setting a cooking time

You have set the heating mode and temperature and you have placed your dish in the oven.

- 1 Touch the ⌚ symbol.
- 2 Use ▶ to select the ⌚ "Cooking time" function.

- 3 Set the desired cooking time using the rotary selector.



- 4 Press ▶ to start.

The appliance starts. The timer menu is closed. The settings for temperature, heating mode, elapsing time and cooking time end are shown in the display.

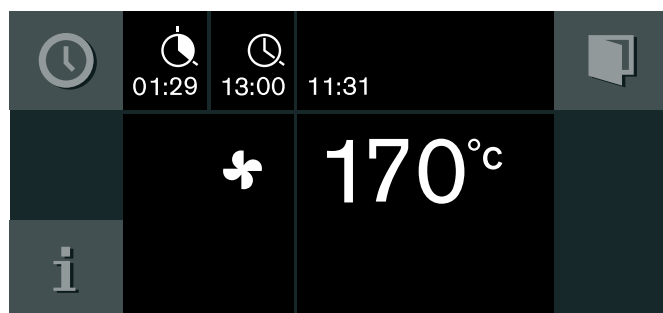

During the last minute of the cooking time the remaining time is displayed in an enlarged format.

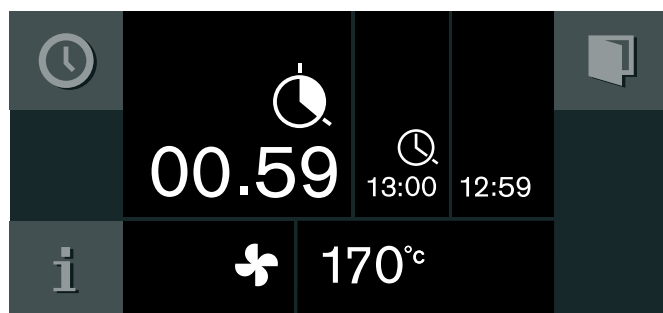

The appliance switches off after the cooking time has elapsed. The ⌚ symbol flashes and a signal sounds. The signal stops when you touch the ✓ symbol, open the appliance door, or switch the function selector to 0.

Changing the cooking time:

Call up the timer menu. Use ▶ to select the ⌚ "Cooking time" function. Change the cooking time using the rotary selector. Press ▶ to start.

Clearing the cooking time:

Call up the timer menu. Use ▶ to select the ⌚ "Cooking time" function. Clear the cooking time with C. Return to normal operation with X.

Cancelling the entire operation:

Set the function selector to 0.

Note: You can also change the heating mode and temperature during the cooking time.

End of cooking time

You can delay the cooking time end to a later time.

Example: it is 14:00. The dish requires a cooking time of 40 minutes. You want it to be ready at 15:30.

Enter the cooking time and delay the cooking time end until 15:30. The electronics system calculates the start time. The appliance starts automatically at 14:50 and switches off at 15:30.

Bear in mind that food which spoils easily should not be left in the cooking compartment for too long.

Delaying the cooking time end

You have set the heating mode, temperature and cooking time.

- 1 Touch the ⌚ symbol.
- 2 Use ▶ to select the ⌚ "Cooking time end" function.

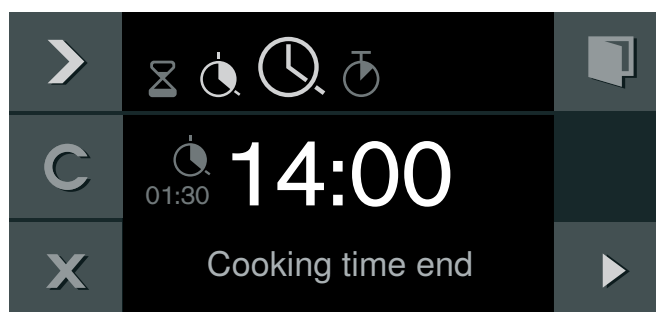

- 3 Set the desired cooking time end using the rotary selector.

- 4 Press ▶ to start.

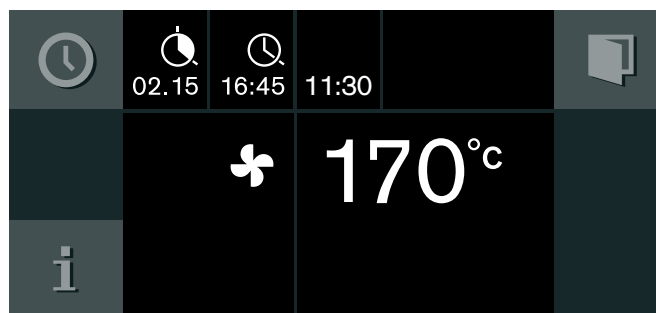

The appliance switches to standby. The heating mode, temperature, cooking time and cooking time end appear in the display. The appliance starts at the calculated time and switches off automatically when the cooking time has elapsed.

Note: If the ⌚ symbol flashes: You have not set the cooking time. Always set the cooking time first.

Once the cooking time has elapsed, the appliance switches off. The ⌚ symbol flashes and an audible signal sounds. The signal stops early if you touch the ✓ symbol, open the appliance door, or set the function selector to 0.

To change the cooking time end:

Call up the timer menu. Use ▶ to select the ⌚ "Cooking time end" function. Set the desired cooking time end using the rotary selector. Press ▶ to start.

To terminate the whole procedure:

Set the function selector to **0**.

Once the set time has elapsed, the appliance stops heating. Turn the function selector to **0**.

Switching off:

To end the process, turn the function selector to **0**.

Long-term timer

With the appliance in hot air mode, this function keeps the temperature between 50 and 230 °C.

You can keep food warm for up to 74 hours without having to switch the appliance on and off.

Bear in mind that food which spoils easily should not be left in the oven for too long.

Note: To use the long-term timer, you will need to set it to "available" in the basic settings. → "Basic settings" on page 32

Setting the long-term timer

- 1 Set the function selector to ☼.
- 2 Touch the ⌚ symbol.
The default value 24 hrs at 85 °C appears in the display. Press ▶ to start
-or-
Change the cooking time, the cooking time end and the switch-off date.

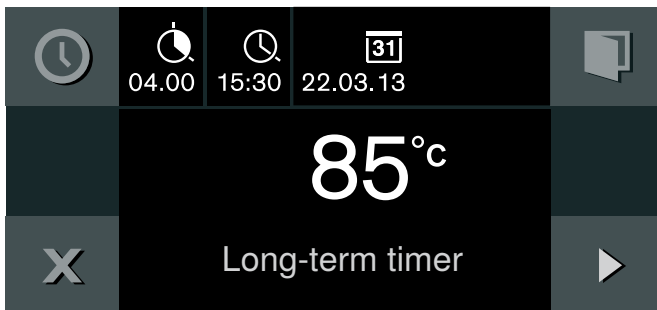

- 3 Changing the cooking time ⌚:
Touch the ⌚ symbol. Set the required cooking time using the rotary selector.
- 4 Changing the cooking time end ⌚:
Touch the ▶ symbol. Set the required cooking time end using the rotary selector.
- 5 Changing the switch-off date [31]:
Touch the ▶ symbol. Set the required switch-off date with the rotary selector. Confirm with ✓.
- 6 Changing the temperature:
Set the required temperature with the rotary selector.
- 7 Press ▶ to start.

The appliance starts. ⌚ and the temperature appear in the display.

The oven and display lighting are switched off. The control panel is locked; no key tone sounds when you touch the touch keys.

Automatic programmes

You can prepare a wide range of food using the automatic programmes. The appliance will choose the optimal setting for you.

To achieve good results, the cooking compartment must not be too hot for the type of food you have selected. If it is, a message will appear on the display. Allow the appliance to cool and then try again.

Information on the settings

- The cooking result depends on the quality of the food and the size and type of cookware. For an optimal cooking result, only use food that is in good condition and meat that is chilled to refrigerator temperature. For frozen food, only use food straight out of the freezer.
- The automatic programme suggests a temperature, type of heating and cooking time.
- For some dishes, you will be required to enter the weight. It is not possible to set weights outside the preprogrammed weight range.
- For some dishes, you will be asked to enter desired level of browning, the thickness of the food and/or the cooking level of the meat or vegetables.
- For some dishes, the cooking compartment is preheated empty. Place the food in the cooking compartment once the preheating is complete and a message appears in the display.
- Your preferred settings will be shown next time as a suggestion.

Core temperature probe

For some recipes, you will need the core temperature probe. Use the core temperature probe for these recipes. → "Core temperature probe" on page 24

Selecting a dish

The following categories are available. One or more dishes are listed beside each category.









Categories:

- Vegetables
- Oven dishes
- Fish
- Meat and poultry
- Bread, pizza and cake
- Drying
- Dough mixture

Applying settings for a dish

You are guided through the entire setting process. Follow the instructions in the display.

Use the rotary selector to scroll through the individual levels.

- 1 Set the function selector to .
- 2 Touch the  symbol. Press  to confirm.
- 3 Use the rotary selector to select the category and press  to confirm.
- 4 Use the rotary selector to select the required dish and press  to confirm.
The possible settings appear in the display. For many dishes, you can change the settings to suit your needs.
For some dishes, you must set the weight.
Tip: By touching the  symbol you will receive additional information regarding accessories and cooking preparation.
- 5 Press  to confirm the required settings. Follow information shown on the display. Press  to start. The time counts down on the display.

Once the cooking time has elapsed, an audible signal sounds. The appliance stops heating. Turn the function selector to **0**.

Warning – Risk of scalding!



When you open the appliance door, hot steam may escape. Open the appliance door with care. Keep children at a safe distance.

Opening the appliance door affects the cooking result. Open the appliance door only briefly. The automatic programme is interrupted and continues to run after closing the appliance door.

Adding extra cooking time

After the cooking time has ended, you can leave some dishes to continue cooking if you are not satisfied with the cooking result.

A query appears in the display asking if you want to continue cooking.

- 1 Press  to confirm.
- 2 Select a single or double cooking time, depending on requirements.
- 3 Press  to start.
- 4 If the "Continue cooking" function has ended, turn the function selector to **0**.





Changing and cancelling

After starting the appliance, the settings can no longer be changed.

If you want to cancel the operation, turn the function selector to **0**.

Calling up the last automatic programmes used

The last five dishes with the selected settings are saved. You have the option of saving these dishes with the selected settings as individual recipes. → *"Individual recipes" on page 22*





- 1 Set the function selector to .  is displayed.
- 2 Touch the  symbol.
- 3 Use the rotary selector to select "Last automatic programmes" and press  to confirm.
- 4 Use the rotary selector to select the required dish and press  to confirm.
- 5 Enter a name for the dish and save. → *"Entering names" on page 23*

Individual recipes

It is possible to save up to 50 individual recipes. You can record a recipe. These recipes can be given a name so that they can be called up quickly and conveniently when required.

Recording a recipe

It is possible to set up to 5 phases consecutively while recording at the same time.

- 1 Set the function selector to .
- 2 Touch the  symbol.
- 3 Use the rotary selector to select "Individual recipes" and press  to confirm.
- 4 Use the rotary selector to select a free memory location.
- 5 Touch the  symbol.





- 6 Use the rotary selector to set the required temperature.
- 7 The cooking time will be recorded.
- 8 To record another phase:
Turn the function selector to the required type of heating. Use the rotary selector to set the required temperature. This will start a new phase.
- 9 Once you have obtained the cooking result you want for the dish, touch the  symbol to finish the recipe.
- 10 Enter a name for the recipe in "ABC". → *"Entering names" on page 23*

Notes





- The appliance will not start recording a phase until it has reached the set temperature.
- Each phase must last at least 1 minute.
- During the first minute of a phase, you can change the type of heating or the temperature.

Set a core temperature for a phase:





Connect the core temperature probe to the socket in the oven. Set the heating mode and the temperature. Touch the  symbol. Select the core temperature using the rotary selector and touch  to confirm.

Programming a recipe

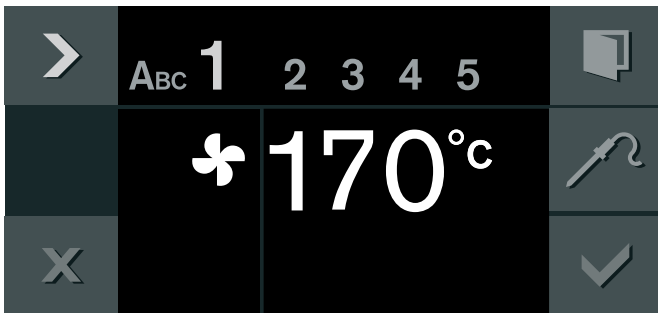

You can programme and save up to five preparation phases.

- 1 Set the function selector to .
- 2 Touch the  symbol.
- 3 Use the rotary selector to select "Individual recipes" and press  to confirm.
- 4 Use the rotary selector to select a free memory location.
- 5 Touch the  symbol.
- 6 Enter a name for the recipe in "ABC". → "Entering names" on page 23
- 7 Use the  symbol to select the first phase. The initial type of heating and temperature is displayed. You can change the type of heating and the temperature by using the rotary selectors.



- 8 Use the  symbol to select the time setting.
- 9 Set the required cooking time using the rotary selector.
- 10 Use the  symbol to select the next phase.
- or -
If preparation is complete, finish making entries.
- 11 Save with .
- or -
Cancel with  and exit the menu.

Setting the core temperature for a phase:



Use the  symbol to select the next phase. Set the heating function and temperature. Touch the  symbol. Use the rotary selector to set the desired core temperature and press  to confirm.

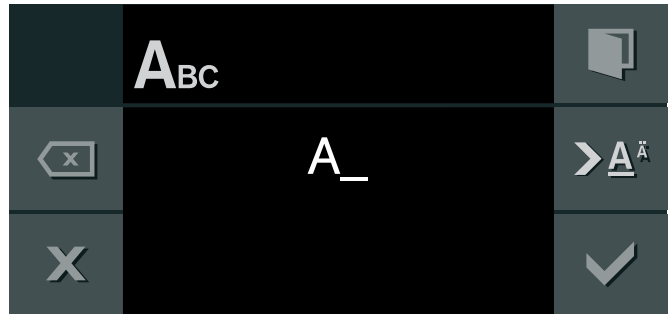

Note: Cooking time cannot be set for phases with a programmed core temperature.

Entering names

- 1 Enter the name of the recipe in "ABC".







Rotary selector	Select letters A new word always begins with a capital letter.
	Press briefly: moves the cursor right Press and hold: shifts to umlauts and special characters Press twice: adds a line break
	Press briefly: moves the cursor right Press and hold: shifts to normal characters Press twice: adds a line break
	Deletes letters

- 2 Save with .
- or -
Cancel with  and exit the menu .

Note: For entering a name, Latin characters, certain special characters and numbers are available.

Starting recipes

- 1 Set the function selector to .
- 2 Touch the  symbol.
- 3 Use the rotary selector to select "Individual recipes" and press  to confirm.
- 4 Use the rotary selector to select the desired recipe.
- 5 Press  to start.
The operation starts. The cooking time starts counting down.
The settings for each phase are shown in the display.

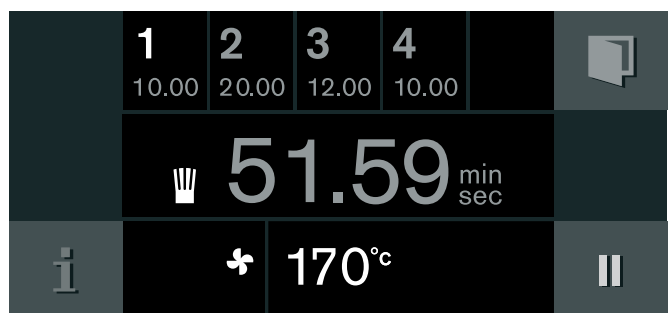







Notes





- The cooking time does not start counting down until the appliance has reached the set temperature.
- You can use the rotary selector to change the temperature while the recipe is in progress. This does not change the saved recipe.
- Insert the core temperature probe, if the recipe contains a saved core temperature.

Change recipe

You can change the settings of a recorded or programmed recipe.

- 1 Set the function selector to .
- 2 Touch the  symbol.
- 3 Use the rotary selector to select "Individual recipes" and press  to confirm.
- 4 Use the rotary selector to select the desired recipe.
- 5 Touch the  symbol.
- 6 Use the  symbol to select the desired phase. The programmed type of heating, temperature and cooking time are displayed. You can use the rotary selector or function selector to change the settings.
- 7 Save with .
- or -
Cancel with  and exit the menu.

Deleting recipes

- 1 Set the function selector to .
- 2 Touch the  symbol.
- 3 Use the rotary selector to select "Individual recipes" and press  to confirm.
- 4 Use the rotary selector to select the desired recipe.
- 5 Delete the recipe with .
- 6 Press  to confirm.

Core temperature probe

The core temperature probe makes it possible to cook with exact precision. It measures the temperature inside the food. When the required core temperature has been reached, the probe switches off automatically, ensuring that all food is cooked perfectly.

Warning – Risk of electric shock!

The insulation of an incompatible meat probe may be damaged. Only use the meat probe which is recommended for this appliance.

Warning – Risk of burns!

The cooking interior and the core temperature probe become very hot. Use oven mitts to plug and unplug the core temperature probe.

Caution!

Damage to the core temperature probe:

Do not use the core temperature probe with the full surface grill or compact grill heating types. Before using full surface grill or compact grill, remove the core temperature probe from the cooking compartment. It is possible to use the full surface grill heating type and air recirculation at temperatures up to 250 °C.

Caution!

Damage to the core temperature probe:

The core temperature probe may be damaged at temperatures above 250 °C. When using the core temperature probe, never set the temperature above 250 °C.

Only use the core temperature probe supplied. You can purchase it as a spare part from the after-sales service or from the online shop.

When using the core temperature probe, never place the food on the top shelf position in the oven.

After use, always remove the core temperature probe from the cooking compartment. Never store it inside the cooking compartment.

After each use, clean the core temperature probe with a damp cloth. Do not clean in the dishwasher.

Inserting the core temperature probe into the food

Insert the core temperature probe into the food before you place the food in the cooking compartment.

The core temperature probe has three measuring points. Insert the core temperature probe as far as possible. Ensure that the middle measuring point is inserted in the food. It must not be inserted in the fat or be touching the ovenware or bones.

Meat: For large pieces of meat, insert the core temperature probe at an angle from above as far as it will go into the meat.

For relatively thin pieces of meat, insert the meat probe from the side at the thickest point.

If there is more than one piece of meat, insert the core temperature probe into the middle of the thickest piece.

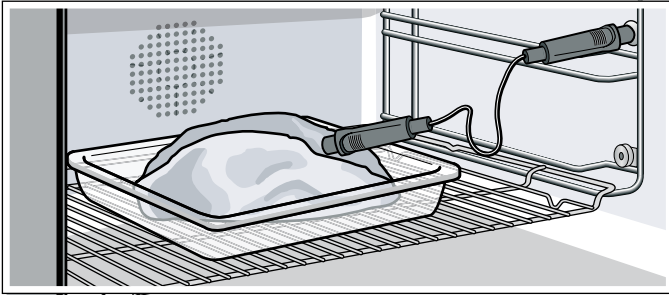

Poultry: Insert the core temperature probe as far as it will go into the thickest point in the breast. Depending on its structure, insert the core temperature probe into the poultry crossways or lengthways. With poultry, make sure that the tip of the core temperature probe does not protrude into the cavity in the middle of the bird.

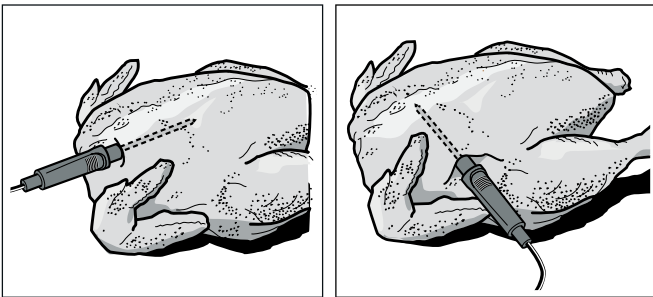

Fish: Insert the core temperature probe behind the head as far as it will go towards the spine. Place the whole fish onto the wire rack and prop it up in the swimming position using half a potato.

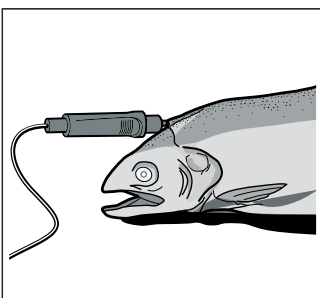

Turning the food: If you want to turn the food, do not remove the core temperature probe. Once you have turned the food, check that the core temperature probe is correctly positioned in the food.

If you remove the core temperature probe during operation of the appliance, all settings are reset and you have to apply them again.

Setting the core temperature

Caution!



Damage to the core temperature probe:

The core temperature probe may be damaged if the distance between the grill heating element and the core temperature probe is too small. Make sure that the distance between the grill heating element and the core temperature probe or the cable of the core temperature probe is a few centimetres. The meat may expand during the cooking process.

Caution!

Damage to the core temperature probe:

Do not trap the cable of the core temperature probe in the appliance door.

- 1 Slide the food into the cooking compartment with the core temperature probe inserted. Plug the core temperature probe into the socket in the cooking compartment and close the appliance door.
- 2 Turn the function selector to the required type of heating.
- 3 Use the rotary selector to set the cooking compartment temperature.
- 4 Touch the  symbol. Using the rotary selector, set the desired core temperature for the food and press  to confirm. The set core temperature must be higher than the current core temperature.
- 5 The appliance heats up using the type of heating that has been set. The current core temperature is shown in the display, and beneath it, the set core temperature. You can change the set core temperature at any time.
- 6 After preheating, the display shows an estimated cooking time approx. 5–20 minutes into the cooking time. Touch the  symbol to display the current core temperature.

Once the food reaches the core temperature that has been set, an audible signal will sound. Cooking ends automatically. Confirm with  and turn the function selector to 0.

Estimated cooking time

After preheating, if the appliance has a temperature setting above 100 °C, when the core temperature probe is inserted, the display shows an estimated cooking time approx. 5–20 minutes into the cooking time.

The estimated cooking time is continually updated. The longer the cooking process lasts, the more precise the estimated cooking time becomes. Do not open the appliance door; this distorts the estimated cooking time.

The estimated cooking time is displayed in normal operation and in the automatic programme.



The current core temperature is shown in the display when you touch the  symbol.

The estimated cooking time display can be deactivated in the basic settings so that the current core temperature is shown instead. → "Basic settings" on page 32

Notes

- The measurable range is 15 °C to 99 °C. Outside the measurable area, "--°C" is displayed for the current core temperature.
- If you leave food in the cooking compartment for some time after cooking, the core temperature will continue to rise somewhat due to the residual heat in the cooking compartment.
- If you set programmes with the core temperature probe and the cooking timer at the same time, the appliance switches off whichever programme reaches the entered value first.

Changing the set core temperature

Touch the  symbol. Use the rotary selector to change the set core temperature for the food and press  to confirm.

Deleting the set core temperature

Touch the  symbol. Delete the set core temperature with **C**. The appliance continues heating in normal cooking operation.

Suggested values for the core temperature

Only use fresh food that has not been frozen. The figures in the table are given as a guide. They will depend on the quality and composition of the food.

For hygiene reasons, critical foodstuffs such as fish and game should reach a core temperature of 62–70 °C; for poultry and minced meat this should be as high as 80–85 °C.

Food	Suggested value for the core temperature
Beef	
Sirloin, fillet of beef, entrecôte	
Very rare	45–47 °C
Rare	50–52 °C
Medium rare	58–60 °C
Well done	70–75 °C
Roast beef	80–85 °C
Pork	
Joint of pork	
Loin of pork	72–80 °C
Medium rare	65–70 °C
Well done	75 °C
Meat loaf	85 °C

Food	Suggested value for the core temperature
Veal	
Fillet of pork	
	65–70 °C
Game	
Joint of veal, well done	
	75–80 °C
Breast of veal, stuffed	
	75–80 °C
Saddle of veal	
Medium rare	58–60 °C
Well done	65–70 °C
Fillet of veal	
Rare	50–52 °C
Medium rare	58–60 °C
Well done	70–75 °C
Poultry	
Saddle of venison	
	60–70 °C
Leg of roe venison	
	70–75 °C
Venison loin steaks	
	65–70 °C
Saddle of hare or rabbit	
	65–70 °C
Lamb	
Chicken	
	90 °C
Guinea fowl	
	80–85 °C
Goose, turkey, duck	
	85–90 °C
Duck breast	
Medium rare	55–60 °C
Well done	70–80 °C
Ostrich steak	
	60–65 °C
Mutton	
Leg of lamb	
Medium rare	60–65 °C
Well done	70–80 °C
Saddle of lamb	
Medium rare	55–60 °C
Well done	65–75 °C
Mutton	
Leg of mutton	
Medium rare	70–75 °C
Well done	80–85 °C
Saddle of mutton	
Medium rare	70–75 °C
Well done	80 °C
Fish	
Fillet	
	62–65 °C
Whole	
	65 °C
Terrine	
	62–65 °C
Other	
Bread	
	96 °C
Pâté	
	72–75 °C
Terrine	
	60–70 °C
Foie gras	
	45 °C

Rotary spit

Use the rotisserie spit to grill large roasts or poultry. Grilling with the rotisserie spit produces a crispy crust and even browning all-round.

You can use the rotisserie spit in all heating modes. You get the best results in the "full surface grill" or "top heat" modes.

Caution!

Do not use the temperature probe in combination with the rotisserie spit.

Preparation

- 1 Push both spit holders in the fittings on the grill tray. The rotary drive is on the left.
- 2 Slide the right retaining clip onto the spit and tighten the screw.
- 3 Place the food you want to prepare on the rotisserie spit. Secure protruding parts (e.g. wings) to make sure they do not touch the grill heating element.

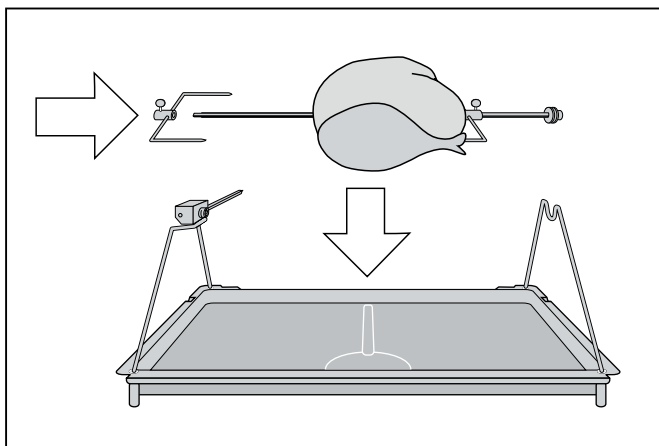

- 4 Slide the left retaining clip onto the spit and tighten the screw.
- 5 Place the spit onto the spit holders. Insert the square edge into the drive.

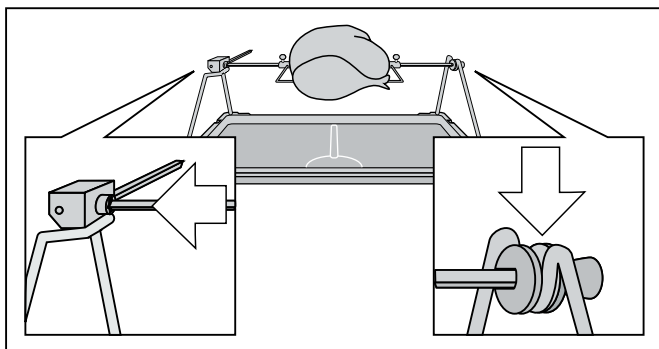

- 6 Insert the grill tray and the rotisserie spit on the lowest level of the oven. The drive shaft has to engage into the opening on the back of the oven interior.

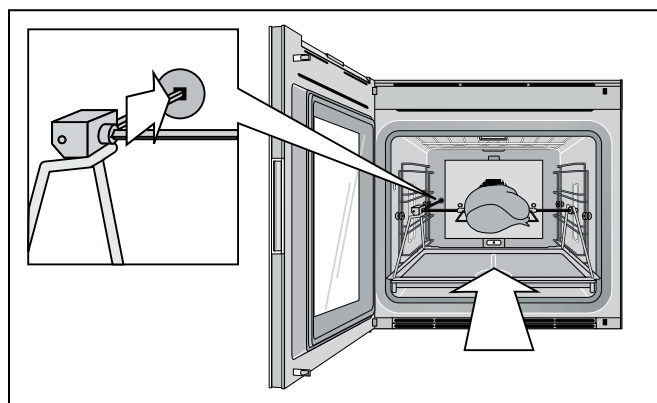

Switching on the rotisserie spit

- 1 Set the required temperature and heating mode.
- 2 Touch the  symbol. The rotisserie spit begins to turn.



Switching off the rotisserie spit

- 1 Touch the  symbol. The rotisserie spit's drive stops.
- 2 Switch off the oven with the rotary selector.
- 3 Take out the grill tray with the rotisserie spit and place them on a stable, heat-resistant surface.
 - ⚠ Warning – Risk of burns!**
Use an oven glove to remove the grill tray.
- 4 Screw on the handle at the side to remove the rotisserie spit.

Notes

- Use the rotisserie spit at oven temperatures up to 250°C only.
- Do not clean the drive part of the rotisserie spit in a dishwasher.

Roasting function

Only when set to the "Roaster function" heating type. You will need a roaster, pull-out system and heating element – these are optional accessories.

With the roasting function, the oven heats up at full capacity for approx. 3 minutes. You can use this function to sear steaks, for example.

Touch the **»»** symbol. The roasting function starts. You can also set the roasting function several times consecutively.

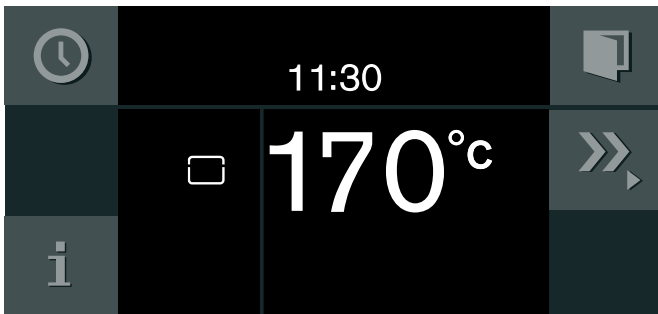

To end the roasting function early, touch the **»»** symbol.

Childproof lock

The appliance has a childproof lock to prevent children operating it accidentally.

Notes

- To use the childproof lock, you will need to set it to "available" in the basic settings. → "Basic settings" on page 32
- If there is a power cut after the childproof lock has been activated, the childproof lock may be deactivated when the power comes back on.

Activate the child lock

Prerequisite:

The function selector is set to **0**.

Touch and hold the **🔒** symbol for at least 6 seconds.

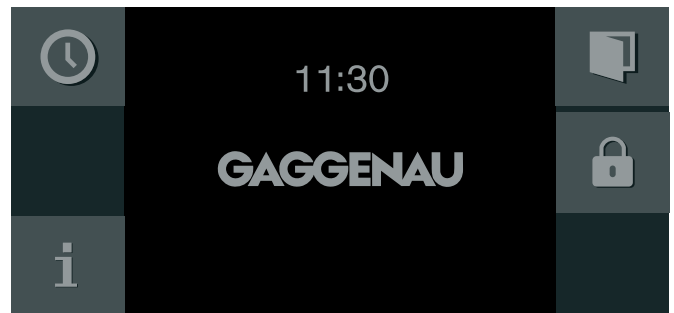

The child lock is activated. The standby screen appears. The **🔒** symbol is shown at the top of the display.

Deactivating the child lock

Prerequisite:

The function selector is set to **0**.

Touch and hold the **🔒** symbol for at least 6 seconds.

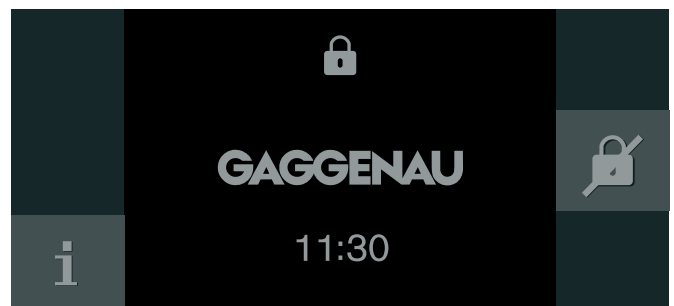

The child lock is deactivated. You can set the appliance as usual.

Home Connect

This appliance can be networked and controlled remotely using a mobile device. The Home Connect app offers extra functions that complement the networked appliance perfectly. If the appliance is not connected to your home network, it can be operated as usual via the display.

The availability of the Home Connect function depends on the availability of Home Connect services in your country. Home Connect services are not available in every country. You can find more information on this at www.home-connect.com.

Notes

- Ensure that you follow the safety instructions in this instruction manual and that you comply with these even when you are away from home and are operating the appliance via the Home Connect app. You must also follow the instructions in the Home Connect app.
- Operating the appliance directly from the appliance always takes priority. It is not possible to operate the appliance using the Home Connect app during this time.
- Refer to the Home Connect documents supplied for more information.

Setting up

To configure settings via Home Connect, you will need to have installed the Home Connect app on a mobile device.

Your appliance will also need to be connected to your home network and to the Home Connect app. You can choose between the following connection types:

- Connection via LAN cable: The appliance is connected to the home network automatically following confirmation on the appliance.
- Connection via WLAN: Establish the connection to your home network and then the connection to the Home Connect app.

Note: The app will guide you through the entire registration process. In case of doubt, follow the instructions in the app.

Installing the app

Install the Home Connect app on your mobile device (e.g. tablet PC or smartphone).

- 1 On your mobile device, go to the App Store (Apple devices) or the Google Play Store (Android devices).
- 2 Enter the search term "Home Connect".

- 3 Select the Home Connect app and install it on your mobile device.
- 4 Launch the app and set up Home Connect access. The app will guide you through the registration process.





Connecting the appliance to your home network (LAN)

The appliance must be connected to your home network using a LAN cable.

The network connection will be established automatically when the appliance is connected to the mains electricity supply for the first time and put into operation.





Connecting the appliance to your home network (WLAN with WPS)

Requirements:

- Your router must have a WPS button. You will find information about this in the manual for your router.
 - You need to be able to access your router.
- 1 In the basic settings, select  "Home Connect".
 - 2 Touch the  symbol.
 - 3 Turn the rotary selector to "WLAN".
 - 4 Touch the  symbol to confirm. A message about the WPS function will appear.
 - 5 Touch the  symbol to continue.
 - 6 Turn the rotary selector to "Automatic (WPS)".
 - 7 Touch the  symbol to start the connection process.
 - 8 Press the WPS button on the router within the next 2 minutes.

If the display shows "Network connection successful", the connection process is complete. Follow the instructions in the app.

Connecting the appliance to your home network (WLAN without WPS)



- 1 In the basic settings, select  "Home Connect".
- 2 Touch the  symbol.
- 3 Turn the rotary selector to "WLAN".
- 4 Touch the  symbol to confirm. A message about the WPS function will appear.
- 5 Touch the  symbol to continue.
- 6 Turn the rotary selector to "Manual".
- 7 Touch the  symbol to start the connection process. The appliance will set up its own "Home Connect" WLAN network to which the tablet or smartphone must be connected.
- 8 Follow the instructions in the app.

If the display shows "Network connection successful", the connection process is complete. Follow the instructions in the app.

Connecting the appliance to the app

Connect your appliance to the app when setting up Home Connect or connect your appliance to an additional Home Connect account. The Home Connect app can be installed on any number of mobile devices, which can then be connected to the appliance.





Requirements:

- The appliance is connected to the home network.
 - The Home Connect app has been installed on the mobile device.
- 1 To connect an additional account, select "Home Connect" in the basic settings.
 - 2 Use the rotary selector to select "Connect to app".
 - 3 Touch the  symbol and start the connection process with .
 - 4 Follow the instructions in the app.

If the display shows "Connection to app successful", the connection process is complete.

Home Connect settings

Home Connect can be adapted to your specific needs at any time.

	Basic setting	Permitted settings	Explanation
	Connection type	LAN/Wi-Fi	You can switch between connection types (LAN cable and Wi-Fi). Follow the instructions for setting up the relevant connection type. → "Setting up" on page 29
	Connecting	Connect/disconnect	Switch the network connection on or off as required (e.g. for holiday). Network information is retained after the appliance is switched off. After switching on the appliance, you will need to wait for a few seconds while it reconnects to the network. In networked standby mode, the appliance requires max. 2 W.
	Connect to app		Start the connection process between the app and the appliance.
	Software update		As soon as a new software version is available, a message appears in the display. You can install the new software in the Home Connect menu  .

Remote Start



Remote start must be activated in order to start and operate your appliance via the Home Connect app. If remote start is deactivated, the Home Connect app will only show the operating modes of the appliance and let you configure the settings.

Remote start is automatically deactivated in the following situations:

- The appliance door is opened at least 15 minutes after remote start has been activated.
- The appliance door is opened at least 15 minutes after operation has ended.
- 24 hours after remote start has been activated.

When you start a type of heating using the controls on the appliance, remote start is activated automatically. You can now make changes or start a new programme from your mobile device.



Activating remote start

- 1 Set the function selector to .
- 2 Touch the  symbol.
The symbol  appears next to the **i** symbol.

Remote start is activated. You can now start a heating mode via the app on the mobile device and send the desired settings to the appliance.

Touch the  symbol to deactivate remote start.

Note: You will find the Home Connect settings in the basic settings for your appliance. Which settings the display shows will depend on whether Home Connect has been set up and whether the appliance is connected to your home network.

	Remote control	Activate/deactivate	Access the appliance's functions via the Home Connect app. When deactivated, only the appliance's operating statuses will be displayed in the app.
	Delete network settings		All network settings can be deleted from the appliance at any time.
	Appliance information		The display shows: <ul style="list-style-type: none"> ● MAC address COM module ● Serial number of the appliance ● Software version You can view more information – such as the SSID (network name), although this depends on the connection type – by touching the arrow button.

Remote diagnostics

If a fault occurs, the after-sales service can use remote diagnostics to access your appliance.

Contact the after-sales service, making sure that your appliance is connected to the Home Connect server and checking that the remote diagnostics service is available in your country.

Note: For more information and to check whether the remote diagnostics service is available in your country, please visit the Help & Support area of the Home Connect website for your country: www.home-connect.com

About data protection

When your appliance is connected for the first time to a WLAN network, which is connected to the Internet, your appliance transmits the following categories of data to the Home Connect server (initial registration):

- Unique appliance identification (consisting of appliance codes as well as the MAC address of the installed WiFi communication module).
- Security certificate of the WiFi communication module (to ensure a secure IT connection).
- The current software and hardware version of your domestic appliance.
- Status of any previous resetting to factory settings.

This initial registration prepares the Home Connect functions for use and is only required when you want to use these Home Connect functions for the first time.

Note: Ensure that the Home Connect functions can be used only in conjunction with the Home Connect app. Information on data protection can be accessed in the Home Connect app.

Declaration of Conformity

Gaggenau Hausgeräte GmbH hereby declares that the appliance which features Home Connect is in accordance with the basic requirements and the other relevant provisions of the directive 2014/53/EU.

A detailed RED Declaration of Conformity can be found online at www.gaggenau.com on the product page for appliance in the additional documents.



2.4 GHz band: max. 100 mW

5 GHz band: max. 100 mW

	BE	BG	CZ	DK	DE	EE	IE	EL
	ES	FR	HR	IT	CY	LV	LT	LU
	HU	MT	NL	AT	PL	PT	RO	SI
	SK	FI	SE	UK	NO	CH	TR	

5 GHz Wi-Fi: for indoor use only

Basic settings

Your appliance can be individually adjusted in the basic settings.

- 1 Turn the function selector to **S**.
- 2 Select "Basic settings" using the rotary selector.
- 3 Touch the ✓ symbol.
- 4 Turn the rotary selector to select the required basic setting.













5 Touch the ↵ symbol.



















6 Set the basic setting using the rotary selector.

7 Save with ✓ or cancel with ✕ and exit the current basic setting.

8 Turn the function selector to **0** to exit the basic settings menu.

The changes are saved.

	Basic setting	Permitted settings	Explanation
	Brightness	Level 1, 2, 3, 4, 5*, 6, 7, 8	Sets the display brightness
	Standby screen	On*/Off - Clock - Clock + GAGGENAU logo* - Date - Date + GAGGENAU logo - Clock + date - Clock + date + GAGGENAU logo	Appearance of the standby screen. Off: No display. Use this setting to reduce the standby consumption of your appliance. On: Several displays can be set, confirm "On" with ✓ and use the rotary selector to select the desired display. The selection is displayed.
	Display	Reduced*/Standard	If the 'Reduced' setting has been selected, only the most important information will be shown on the display after a short time.
	Touch field colour	Grey* / White	Selects the colour of the symbols on the touch fields
	Touch field tone	Tone 1* / Tone 2 / Off	Selects an audible signal for when a touch field is touched
	Touch field tone volume	Level 1, 2, 3, 4, 5*, 6, 7, 8	Sets the volume of the touch field tone
	Rapid heating	On*/off	With rapid heating, the required temperature is reached particularly quickly.
	Preheating signal	On* / Off	The signal tone sounds when the cooking compartment has heated up to the required temperature.
	Signal volume	Level 1, 2, 3, 4, 5*, 6, 7, 8	Sets the volume of the audible signal
	Time format	AM/PM / 24 h*	Display the clock in 24 or 12-hour format
	Time	Current time	Setting the clock
	Clock change	Manual* / Automatic	Automatically changes the clock to daylight-savings time. If automatic: Setting the month, day and week for when the time should be changed over. To be set for both summer and winter time.
	Date format	D.M.Y* D/M/Y M/D/Y	Sets the date format

	Date	Current date	Sets the date. You can switch between year/month/day using the symbol >.
	Temperature unit	°C* / °F	Setting the temperature unit
	Weight unit	kg*/oz.	Set the weight unit
	Language	German* / French [...] / English	Select the language for the text display Note: The system will restart if the language is changed. This process takes a few seconds. The basic settings menu is then closed.
	Factory settings	Restore appliance to factory settings	Confirm the question "Delete all individual settings made and reset to factory settings?" by pressing ✓ or cancel by pressing X. Note: Individual recipes will also be deleted if the appliance is restored to factory settings. After restoring factory settings, the "Initial settings" menu is displayed.
	Demo mode	On / Off*	Only for presentation purposes. The appliance does not heat up in demo mode, all other functions are available. The "Off" setting must be activated for normal operation. The setting is only possible in the first 3 minutes after connecting the appliance to the mains.
	Long-term timer	Not available*/Available	Available: Long-term timer can be set. → "Long-term timer" on page 20
	Display estimated cooking time with core temperature probe	On*/off	On: Estimated cooking time is shown in the display when the core temperature probe is used.
	Door lock	Off* / On	The door lock prevents unintentional opening of the appliance door. When "On" is set, you must touch the  symbol for several seconds before the door opens.
	Childproof lock	Not available*/Available	Available: The childproof lock can be activated. → "Childproof lock" on page 28
	Home network	<small>LAN / WLAN</small> Connection type  Connection  Connect to app  Software update  Remote control  Delete network settings  Appliance information	Settings for the connection to the home network and the mobile devices. Different setting options will be displayed depending on the connection status.

* Factory setting

Cleaning and maintenance

With thorough care and cleaning your appliance will retain its looks and remain in good order. We will explain here how you should care for and clean your appliance correctly.

Warning – Risk of electric shock!

Do not use any high-pressure cleaners or steam cleaners, which can result in an electric shock.

Warning – Risk of burns!

The appliance becomes very hot. Never touch the interior surfaces of the cooking compartment or the heating elements. Always allow the appliance to cool down. Keep children at a safe distance.

Warning – Risk of burns!

Bulbs become very hot when switched on. There is still a risk of burning for some time after they have been switched off. Allow the bulbs to cool down before cleaning the appliance. Switch off appliance light during cleaning.

Warning – Risk of injury!

Scratched glass in the appliance door may develop into a crack. Do not use a glass scraper, sharp or abrasive cleaning aids or detergents.

Cleaning agents

Pay attention to the information in the table to avoid damaging the various surfaces by incorrect cleaning agents.

Do not use

- harsh or abrasive cleaning agents
- metal or glass scrapers to clean the glass on the appliance door
- metal or glass scrapers to clean the door seal
- hard abrasive pads or cleaning sponges

Thoroughly rinse out new sponge cloths before use.

Area	Cleaning agent
Door panels	Glass cleaner: Clean with a soft cloth or a microfibre cloth. Do not use a glass scraper.
Display	Wipe down using a microfibre cloth or a slightly damp cloth. Do not wipe with a wet cloth.

Area	Cleaning agent
Stainless steel	Hot soapy water: Clean using a dishcloth and then dry with a soft cloth. Remove limescale, grease, starch and albumin (e.g. egg white) stains immediately. Corrosion can form under these patches or splashes. Special stainless-steel cleaning products are available from our after-sales service or from specialist retailers.
Aluminium	Clean with a mild window cleaning agent. Use a window cloth or a non-fluffing microfibre cloth to wipe over the surfaces lightly in a horizontal direction.
Cooking compartment	Hot soapy water: Clean using a dishcloth and then dry with a soft cloth.
Very dirty cooking compartment	Cleaning gel spray for ovens (order number 00311860 from after-sales service or in the online shop). Please note: <ul style="list-style-type: none"> ● The gel must not come into contact with the door seal. ● Leave for no more than 12 hours. ● Do not use on hot surfaces. ● Rinse off thoroughly with water. ● Follow the manufacturer's instructions.
Glass cover for the cooking compartment light	Hot soapy water: Clean with a dishcloth.
Door seal	Hot soapy water: Clean with a dish cloth; do not scrub.
Do not remove.	Do not use a metal or glass scraper for cleaning.
Core temperature probe	Wipe with a damp cloth. Do not clean in the dishwasher.
Accessories	Hot soapy water: Soak and clean with a dish cloth or brush.
Insert grids	For dishwashers, see the section entitled → "Removing the insert grids" on page 35
Rotary spit (not available with all oven models)	Hot soapy water: Clean with a dish cloth or a brush. Do not soak or clean the rotary spit drive in the dishwasher.
Telescopic rails (optional accessory)	Hot soapy water: Clean with a dish cloth or a brush. Do not soak or clean in the dishwasher.
Baking stone (optional accessory)	Remove burnt-on remnants with a brush. Never clean the baking stone with water.
Roaster (optional accessory)	Hot soapy water: Soak and clean with a dish cloth or brush. Do not clean the roaster in the dishwasher.

Microfibre cloth

The honeycomb microfibre cloth is particularly suitable for cleaning sensitive surfaces such as glass, glass ceramic, stainless steel or aluminium (part number 00460770 from our after-sales service or from our online shop). It removes liquid and greasy deposits in one go.

Removing the insert grids

The insert grids can be removed for cleaning.

Removing the insert grids

- 1 Place a dishcloth in the cooking compartment to protect the enamel from scratches.
- 2 Undo the knurled nuts (Fig. A).
- 3 Remove the insert grids (Fig. B).

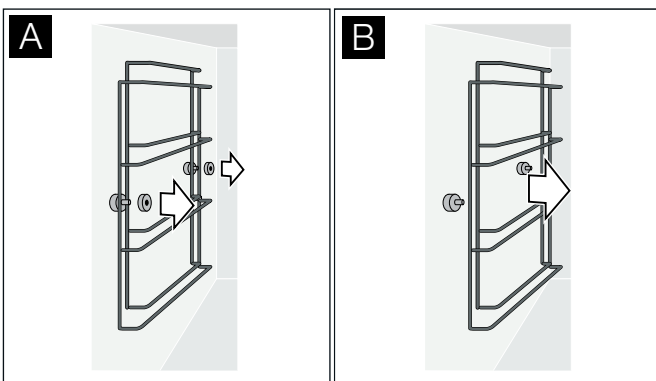

You can clean the insert grids in the dishwasher.

Refitting the insert grids

- 1 Attach the insert grid all the way round: Longer side toward the bottom. The right and left grids are identical.
- 2 Tighten the knurled nuts.

Pyrolytic self-cleaning

⚠ Warning – Risk of fire!

Loose food residues, grease and meat juices may catch fire during pyrolytic cleaning. Remove coarse dirt from the cooking compartment and from the accessories before every pyrolytic cleaning cycle.

⚠ Warning – Risk of fire!

The appliance will become very hot on the outside during the pyrolytic cleaning cycle. Never hang combustible objects, e.g. tea towels, on the door handle. Do not place anything against the front of the oven. Keep children at a safe distance.

⚠ Warning – Risk of serious damage to health!

The appliance will become very hot during the pyrolytic cleaning cycle. The non-stick coating on baking trays and tins is destroyed and noxious gases are released. Never let non-stick baking trays and tins go through the pyrolytic cleaning cycle. Only enamelled accessories may be cleaned at the same time.

⚠ Warning – Risk of burns!

The cooking compartment will become very hot during the pyrolytic cleaning cycle. Never open the appliance door or move the locking latch by hand. Allow the appliance to cool down. Keep children at a safe distance.

⚠ Warning – Risk of burns!

⚠ The appliance becomes very hot on the outside during the cleaning function. Never touch the appliance door. Allow the appliance to cool down. Keep children at a safe distance.





Preparing pyrolytic self-cleaning

Caution!

Risk of fire! Loose food remnants, fat and meat juices may catch fire. Wipe the cooking compartment with a damp cloth.

- Remove the worst soiling and food residues from the oven.
- Clean the door seals, the inside of the door and the glass pane by hand as these parts are not cleaned during the pyrolytic self-cleaning cycle.
- Remove any loose parts from inside the cooking compartment. The shelf supports are pyrolysis-resistant. Make sure that nothing is left inside the cooking compartment.
- Bush for the additional heating element at the back of the cooking compartment: Make sure that the cover is in the bush.
- Close the oven door.

Starting pyrolytic self-cleaning

- 1 Set the function selector to **S**.
- 2 The + symbol is displayed. Confirm with .
- 3 The switch-off time, when pyrolytic self-cleaning will be finished, is displayed. If required, move the switch-off time with the rotary selector. Confirm with .
- 4 Remove all accessories and coarse soiling from the oven interior. Confirm with .
- 5 Press  to start. The cleaning time elapses on the display. If the switch-off time has been shifted, the time up to the start of pyrolytic self-cleaning elapses in the display. The lamp in the oven interior stays off.

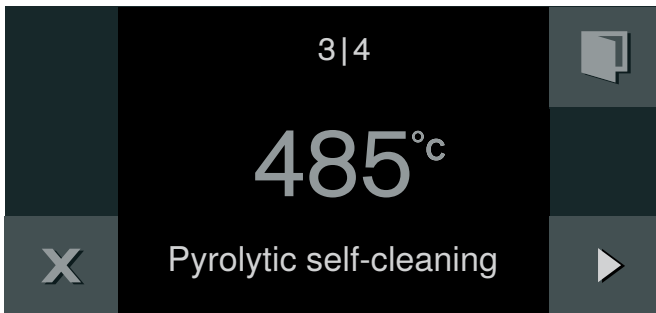

A signal sounds after 3 hours. A message appears in the display. Once the appliance has cooled down, wipe the remaining ash out of the interior with a moist cloth.

Note: For your safety, the oven door is locked. When cooling down, the door lock is released when the temperature drops below 200°C.

Depending on the type of soiling, white deposits may remain on the enamel surfaces. These deposits are residue from the food and are harmless. They do not affect how the appliance works. If required, you can remove these residues using lemon juice and a soft cloth.

Cleaning accessories with pyrolytic self-cleaning

Gaggenau baking trays and grill trays are coated with a pyrolysis-resistant enamel. However, for an optimum oven-cleaning result, we recommend that you remove all accessories from the oven before the pyrolytic self-cleaning. This is the only way to ensure that the heat is distributed evenly.



If you want to remove burnt-in residue from your baking tray or your grill tray, you must observe the following information:

Notes

- Remove any coarse dirt, meat juices and food residue before the pyrolytic self-cleaning. Food residues, grease or meat juices may catch fire during the pyrolytic self-cleaning.
- In each case, only slide one baking tray or grill tray into the lowest shelf in the oven.
- Slide the baking tray or grill tray in as far as it will go.
- Wire rack, rotisserie spit, metal roasting dish, baking stone, core temperature probe or other accessories must not be cleaned in pyrolytic self-cleaning mode.
- Grill trays that have stainless steel bushes may become discoloured during pyrolytic self-cleaning. This has no effect on usability.

What to do in the event of a fault

Malfunctions often have simple explanations. Please read the following notes before calling the after-sales service.

Disruption	Possible cause	Solution
Appliance not working, no display	Plug not inserted	Connect the appliance to the electricity mains
	Power failure	Check whether other kitchen appliances are working
	Fuse defective	Check in the fuse box whether the fuse for the appliance is in working order
	Operating error	Switch off the fuse for the appliance in the fuse box and switch it on again after about 60 seconds
Appliance cannot be started	Appliance door is not quite closed	Close appliance door
The appliance is not working and the display does not respond.  appears in the display	Childproof lock activated	Deactivating the childproof lock → <i>"Childproof lock" on page 28</i>
Appliance switches off on its own	Safety shut-off: the appliance has not been operated for longer than 12 hours	Confirm the message with  , switch off the appliance and set it again.
Appliance does not heat up,  appears in the display	Appliance is in demo mode	Deactivate the demo mode in the basic settings
Error message "Exxx"		If an error message is displayed, turn the function selector to 0 ; if the display goes out, there was a non-recurring problem. If the error occurs repeatedly or the display remains on, please contact the after-sales service and inform them of the error code.

Power cut

Your appliance can bridge a power cut of a few seconds. Operation continues.

If the power cut was for a longer period and the appliance was in operation, a message appears in the display. Operation is interrupted.

Set the function selector to **0**, then the appliance can be operated again as usual.

Demo mode

The  symbol appears on the display when the appliance is in demo mode. The appliance will not heat up.

Briefly disconnect the appliance from the mains (switch off the household fuse or the circuit breaker in the fuse box). Then deactivate demo mode in the basic settings within 3 minutes. → *"Basic settings" on page 32*

Warning – Risk of electric shock!

Incorrect repairs are dangerous. Repairs may only be carried out and damaged power cables replaced by one of our trained after-sales technicians. If the appliance is defective, unplug the appliance from the mains or switch off the circuit breaker in the fuse box. Contact the after-sales service.

Replacing the oven light bulb

The oven light bulbs can be replaced. Heat-resistant halogen bulbs can be obtained from the After-sales service or from a specialist retailer. Always use halogen bulbs of the same type.

- Bulb at the top: 60 W/230 V/G9
- Bulb at the side: 10 W/12 V/G4

Warning – Risk of electric shock!

When replacing the cooking compartment bulb, the bulb socket contacts are live. Before replacing the bulb, unplug the appliance from the mains or switch off the circuit breaker in the fuse box.

Warning – Risk of burns!

Bulbs become very hot when switched on. There is still a risk of burning for some time after they have been switched off. Allow the bulbs to cool down before replacing them.

Note: Always remove the new halogen bulb from the packaging using a dry cloth. This increases the service life of the bulb.

Replacing the ceiling light

- 1 Loosen the screw on the lamp cover. Tilt down the lamp cover.
- 2 Pull out the bulb. Insert the new bulb.
- 3 Tilt the lamp cover up and screw it back on.
- 4 Switch the circuit breaker back on.

Replacing the side light

- 1 Place a tea towel in the oven to prevent damage.
- 2 Pull out the shelf after undoing the knurled nuts.
- 3 Push the top mounting bracket back and remove the glass cover.
- 4 Pull out the bulb. Insert the new bulb.
- 5 Insert the glass cover under the bottom mounting bracket and press it down firmly on the top. The sloping edges of the glass cover must face to the interior of the oven.
- 6 Remove the tea towel.
- 7 Switch the circuit breaker back on.

Replacing the glass cover

If the glass cover in the oven is damaged, it must be replaced. You can obtain covers from the after-sales service. Please supply your appliance's E number and FD number.

After-sales service

Our after-sales service is there for you if your appliance needs to be repaired. We will always find an appropriate solution, also in order to avoid after-sales personnel having to make unnecessary visits.

E number and FD number

When calling us, please give the full product number (E no.) and the production number (FD no.) so that we can provide you with the correct advice. The rating plate bearing these numbers can be found when you open the appliance door.

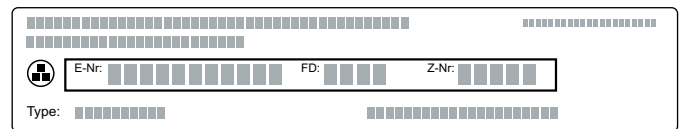

To save time, you can make a note of the number of your appliance and the telephone number of the after-sales service in the space below, should it be required.

E no.

FD no.

After-sales service ☎

Please note that a visit from an after-sales service engineer is not free of charge, even during the warranty period.

Please find the contact data of all countries in the enclosed customer service list.

To book an engineer visit and product advice

GB 0344 892 8988
Calls charged at local or mobile rate.

IE 01450 2655
0.03 € per minute at peak.
Off peak 0.0088 € per minute.

AU 1300 368 339

NZ 09 477 0492

Trust the expertise of the manufacturer, and rest assured that the repair will be carried out by trained service technicians using original spare parts for your domestic appliance.

Tables and tips

Notes

- Always preheat the appliance.
This will produce the best cooking results. The cooking times specified refer to a preheated appliance.
 - The values specified are intended as a guide. The actual cooking time depends on the quality and temperature of the food before cooking, as well as its weight and thickness.
 - The tables list temperature and/or time ranges. Try the lowest value to start with. You can always choose a longer time next time if need be. A lower temperature will result in more even browning. If necessary, set a higher temperature.
 - The figures listed refer to average quantities of food for four people. If you wish to cook a larger quantity of food, you should allow for extra cooking time.
 - Use the cookware specified. If you use other cookware, the cooking times may be longer or shorter.
 - You can use any heat-resistant cookware. Place the cookware in the centre of the wire rack. For large roasts, you can also use the grill tray or glass dish.
 - Do not place too many items close together on wire racks or baking trays. This is the only way to ensure optimal heat circulation.
 - Open the door of the preheated oven for a short time only when placing food inside the cooking compartment.
 - The figures given for the level refer to the rack level (counting from the bottom) in appliances with four rack levels. The figures in brackets refer to appliances with five rack levels.
 - Once you have taken glass cookware out of the oven, set it down on a dry trivet or heat-proof mat; never set it down on a cold or wet surface. Otherwise, the glass may crack.
 - Some operating modes are not available on all oven models or are only available in conjunction with certain optional accessories.
- **Eco hot air:**
Energy-saving hot air mode for cakes, meat, bakes and gratins. Optimal use is made of the residual heat. Convenience functions remain switched off (e.g. the interior lighting). The cooking compartment temperature can only be displayed while the appliance is heating up. Do not preheat the oven.
Make sure that the cooking compartment is cold and that there is nothing already in there when you place the food inside. Then start the specified cooking time. Always keep the appliance door closed when cooking. This will prevent heat loss.
 - **Full surface grill and full surface grill + circulated air:**
In these operating modes, there may be a temperature difference between the temperature you have set and the actual temperature inside the oven. This is because grilling and browning are fast cooking processes that require high temperatures. Consequently, for browning and roasting, a higher temperature than is actually needed on the surface of the food is selected.

Vegetables

- Oven-roasted or oven-baked vegetables are a good alternative to pan-fried vegetables. The different flavours become more concentrated and, because the vegetables are roasted, they have a very distinctive taste. In addition, very little fat is required to prepare the vegetables.
- Clean and prepare the vegetables and mix them with a little oil in a bowl. Place them in a heat-resistant baking dish or tin or in the glass dish/grill tray and spread them out evenly.
- Mix them thoroughly at least once during the cooking process. Once they are cooked, season them and sprinkle them with fresh herbs to taste.
- Vegetables are good as a hot or cold starter or vegetarian main course, or as an accompaniment to meat and fish.
- Use an ovenproof dish for small portions (for 2 - 3 people) and place it on the wire rack. If you use the glass dish/grill tray, the food will start to burn or dry out.
- In addition, always follow the manufacturer's instructions for pre-cooked and frozen products.

Meal	Accessory/ ies	Level	Tempera- ture in °C	Type of heating	Cooking time (mins)	Comments
Vegetable skewers	Wire rack + grill tray	3 (4)	220	~~~~~	24*	Shorten the wooden skewers or leave them to soak in water overnight to prevent them from charring. Recipe tip: Peppers, onions, sweetcorn (pre-cooked), cherry tomatoes, courgettes
Green asparagus, grilled	Glass dish/ grill tray	3 (4)	300	~~~~~	6 - 10*	Recipe tip: Season with onion, oil, vinegar, salt and pepper.
Root vegetables	Glass dish/ grill tray	3 (4)	200	✿	30*	Recipe tip: Season carrots, celery, swede and beetroot with oil, garlic, salt and pepper.
		3 (4)	250	~~~~~	15 - 20*	
Sliced pumpkin	Glass dish/ grill tray	3 (4)	200	✿	30*	Recipe tip: Season with oil, garlic, ginger, cumin, salt and pepper.
Antipasti	Glass dish/ grill tray	3 (4)	200	✿	30*	Recipe tip: Drizzle balsamic vinegar over the vegetables while they are still hot, and season them.
		3 (4)	250	~~~~~	15 - 20*	
Escalivada (Mediterranean oven-roasted vegetables)	Ovenproof dish	4 (5)	250	~~~~~	15*	Recipe tip: Aubergines, onions, tomatoes, peppers, oil. Delicious hot or cold.
Ratatouille	Glass dish/ grill tray	3 (4)	200	---	30 - 40*	Recipe tip: Sprinkle with parmesan just before serving.
Oven-roasted tomatoes	Ovenproof dish	2 (3)	120	✿	60	Recipe tip: Place cherry tomatoes or sliced tomatoes, rosemary and garlic into the baking dish and drizzle with oil and a little honey. If you wish, you can blanch the tomatoes and skin them before roasting them in the oven.
Chicory	Ovenproof dish	2 (3)	180	✿	25 - 30	Recipe tip: Halve, season, wrap in boiled ham, pour cream or béchamel sauce over the top and sprinkle with cheese.
		2 (3)	190	✿ ^e	45 - 50	No need to preheat; do not open the appliance door.
Stuffed peppers, vegetarian	Ovenproof dish/roaster	2 (3)	200	---	30 - 34	Recipe tip: Stuff with boiled rice, soft wheat or lentils and onion, cheese, herbs and seasoning/spices.
Stuffed courgettes, vegetarian	Glass dish/ grill tray	2 (3)	180	✿	25	Recipe tip: Stuff with grated carrot, spring onions, goat's cheese, garlic, thyme, salt and pepper, and sprinkle with parmesan.

* Turn the food halfway through cooking.

Meal	Accessory/ ies	Level	Temperature in °C	Type of heating	Cooking time (mins)	Comments
Vegetable bake	Ovenproof dish	2 (3)	200	---	20 - 30	Pre-cook/blanch vegetables and other ingredients.
Veggie burgers, frozen	Baking tray + grease- proof paper	2 (3)	220	✦	12 - 15*	

* Turn the food halfway through cooking.

Side dishes and meals

- The best known oven-cooked side dishes are potato-based, such as potato gratin. However, you can also obtain excellent results when oven-cooking side dishes that are normally pan-fried, e.g. potato fritters and fried potatoes. The advantages of this preparation method: You can prepare relatively large quantities of food at the same time, the cooking smells do not spread so far in the room, and the food can be prepared using less fat.
- Another highly versatile oven-cooked side dish is cheese. It is a very good addition to vegetarian dishes in particular; depending on the preparation method, you can also serve cheese as a starter or finger food.
- Grilled dishes such as bakes and gratins are particularly well suited to being prepared in the oven. Dishes with a dough or pastry base, e.g. pizza and savoury flan, and egg dishes with a filling, e.g. tortilla, are also suitable.
- Use a heat-resistant baking dish or tin for small portions (2 - 3 people) and place it on the wire rack. If you use the glass dish/grill tray, small portions will start to burn or dry out.
- In addition, always follow the manufacturer's instructions for pre-cooked and frozen products.

Meal	Accessory/ ies	Level	Temperature in °C	Type of heating	Cooking time (mins)	Comments
Side dishes						
Potatoes on a bed of coarse salt	Ovenproof dish	2 (3)	200	---	40 - 60*	Fill the ovenproof dish with 2 cm of sea salt. Place small potatoes into the dish with their skins on and brush them with olive oil.
Potato wedges	Baking tray + greaseproof paper	2 (3)	200	✦	15*	Recipe tip: Cut the potatoes into wedges and season them with olive oil, paprika and salt.
Chips, fresh	Baking tray + greaseproof paper	3 (4)	200	✦	15 - 20*	Recipe tip: Cover with a little oil; season with salt and paprika or curry powder after cooking.
Chips, frozen	Baking tray + greaseproof paper	3 (4)	220	✦	14*	
Potato gratin	Ovenproof dish	2 (3) 2 (3)	180 190	✦ ✦ ^e	35 55 - 60	No need to preheat; do not open the appliance door.
Potato pancakes	Baking tray	2 (3) 2 (3)	175 200	✦ ---	20 - 30* 20 - 30*	Grease the baking tray thoroughly, squeeze the excess liquid out of the potato pancake mixture and brush with a little oil. Turn once.
Roast potatoes	Grill tray	2 (3)	180	✦	30 - 45*	Low-fat preparation. Spread evenly across the grill tray and mix thoroughly several times.

* Turn the food halfway through cooking.

Meal	Accessory/ ies	Level	Tempera- ture in °C	Type of heating	Cooking time (mins)	Comments
Goat's cheese wrapped in bacon	Glass dish/ baking tray	2 (3)	220	☼ ~~~~~	8 - 10	Either goat's cream cheese or goat's cam- embert can be used.
		3 (4)	220		8 - 10	
Goat's cheese with honey	Glass dish/ baking tray	2 (3)	200	☼ ~~~~~	8	Recipe tip: Drizzle lavender honey over the goat's cream cheese or goat's camembert and sprinkle with pine nuts.
		3 (4)	200		8	
Baked camembert, coated with bread- crumbs, fresh	Baking tray + grease- proof paper	2 (3)	180	☼	15 - 20	Bake until the breadcrumb coating rises in the centre.
Baked camembert, coated with bread- crumbs, frozen	Baking tray + grease- proof paper	2 (3)	180	☼ ---	15 - 20	Bake until the breadcrumb coating rises in the centre.
		2 (3)	200		15	
Mozzarella sticks, frozen	Baking tray + grease- proof paper	2 (3)	180	☼	10	
Feta	Baking tray	2 (3)	250	☼ ☼	12	Recipe tip: Place in a baking dish with oil, tomatoes, onion, garlic and rosemary, and season with salt and pepper.
Oven-baked cheese, fresh	Baking tray	2 (3)	180	☼	20	After 10 minutes, cut a cross into the soft cheese and break open. If possible, the dish should be not much larger than the cheese so that the cheese does not run.
Meals						
Tortilla	Ovenproof dish	2 (3)	160	☼	40	Recipe tip: With paprika, olives, onion, Ser- rano ham and Manchego cheese.
Farmer's omelette	Ovenproof dish	2 (3)	160	☼	40	Recipe tip: With green and white asparagus; also add gravlax.
Frittata	Ovenproof dish	2 (3)	190	---	45 - 50	Recipe tip: With spinach, onion and prawns.
Enchiladas, grilled	Glass dish/ grill tray	2 (3)	200	---	15 - 20	
Lasagne	Ovenproof dish	2 (3)	175	☼	35	Recipe tip: Traditional or vegetarian with grilled vegetables and buffalo mozzarella.
		2 (3)	180 - 190	☼ ^e	55 - 60	No need to preheat; do not open the appli- ance door.
Macaroni cheese	Ovenproof dish	2 (3)	180 / 220	☼	10 - 20	To obtain a crust on the cheese, increase the temperature to 220 °C after 10 minutes and leave to brown for a further 10 minutes.
Cheese spätzle (Swabian noodle dish)	Ovenproof dish	2 (3)	180 / 220	☼	30	Gradually layer the freshly cooked spätzle in the dish, sprinkling each layer with cheese. Then top the dish with cheese and roasted onion, raise the temperature to 220 °C and cook for 5 minutes.
Spring rolls, frozen	Baking tray + greaseproof paper	2 (3)	225	☼	18 - 20*	
Mini spring rolls, frozen	Baking tray + greaseproof paper	2 (3)	225	☼	10*	
Pizza, fresh	Baking tray	2 (3)	230 - 250	---	10 - 15	Lightly oil the baking tray.

* Turn the food halfway through cooking.

Meal	Accessory/ ies	Level	Tempera- ture in °C	Type of heating	Cooking time (mins)	Comments
Pizza, pre-baked	Baking tray + greaseproof paper	2 (3)	230	☼	6 - 8	
		2 (3)	230	---	6 - 8	
Pizza, frozen	Wire rack	2 (3)	200	☼	11 - 13	
		2 (3)	220	---	11 - 13	
American pizza (deep pan), frozen	Baking tray	2 (3)	200	---	20 - 24	No need to pre-heat.
Tarte flambée, fresh	Baking tray	2 (3)	250	---	8 - 10	Recipe tip: Traditional or with goat's cheese, Parma ham, figs and spring onions.
Tarte flambée, pre-baked	Baking tray + greaseproof paper	2 (3)	250	☼	7	
Tarte flambée, frozen	Wire rack	2 (3)	200	☼	10 - 12	
		2 (3)	230	---	8 - 10	
Quiche	Tart tin or dish	2 (3)	200	---	20 + 20	Pre-bake the base for 20 minutes, pour the mixture onto the base and then bake for a further 20 minutes.
Onion tart	Baking tray	2 (3)	200	---	30 - 40	



* Turn the food halfway through cooking.

Fish

- For food hygiene reasons, fish should have a core temperature of at least 62 - 70 °C after cooking. This is also the ideal cooking temperature.
- Do not season the fish with salt until it is fully cooked. This ensures that the natural flavour is maintained and that less water is drawn out of the fish.
- Use a small amount of oil to grease the wire rack or baking tray so that the fish does not stick to it.
- For fillets with skin: Place the fish on the rack or tray with the skin side up – this helps to hold the fish together and maintain its flavour.
- Shorten the wooden skewers or, before skewering the ingredients, leave the skewers to soak in water overnight to prevent them from charring.
- In addition, always follow the manufacturer's instructions for pre-cooked and frozen products.

Meal	Accessory/ ies	Level	Tempera- ture in °C	Type of heating	Cooking time (mins)	Comments
Prawn skewers, fresh	Wire rack + grill tray	3 (4)	180	☼	10*	
Prawn skewers, frozen	Wire rack + grill tray	3 (4)	180	☼	12*	
Fish kebabs	Wire rack + grill tray	3 (4)	200	☼	12*	Use firm types of fish, e.g. salmon, coley, ocean perch and cod.
Trout, whole	Baking tray	3 (4)	200 - 220	☼	16*	Recipe tip: Stuff with lemon, garlic and pars- ley.
Sea bream, whole	Wire rack + grill tray	3 (4)	200 - 220	☼	20 - 25*	Recipe tip: Stuff with lemon, garlic and thyme, or use mint for a summery touch.
	Baking tray	3 (4)	175	☼	20 - 25*	Make a diagonal incision into the skin of the sea bream.
Salmon steak	Wire rack + grill tray	3 (4)	250	☼	10 - 12	Recipe tip: Marinate in a mixture of lime, salt, pepper and garlic.
	Baking tray	2 (3)	200	☼	10 - 12	







* Turn the food halfway through cooking.

Meal	Accessory/ ies	Level	Temperature in °C	Type of heating	Cooking time (mins)	Comments
Tuna steak	Baking tray	3 (4)	230		8 - 10	Recipe tip: Season Asian-style with soy sauce, sesame oil, ginger, honey, garlic, chilli and coriander seeds.
Fish fingers, frozen	Baking tray + grease- proof paper	2 (3)	220		15 - 17*	
Squid rings, frozen	Baking tray + grease- proof paper	2 (3)	220		8 - 12	

* Turn the food halfway through cooking.

Meat

- Use the core temperature probe so that you can monitor the core temperature more easily. Information and optimum target temperatures can be found in the section entitled → "Core temperature probe" on page 24.
- Leaving meat to rest: Leave the meat to rest for a further 10–15 minutes after cooking. This gives the meat a chance to "relax". The meat juices begin to circulate less, and when the meat is cut, less juice is lost. Large pieces of meat, e.g. joints, can be left to rest in the oven. Smaller pieces of meat, e.g. steaks, should be wrapped in aluminium foil and left to rest outside the oven.
- For small portions (2–3 people), it is a good idea to use a heat-resistant baking dish or tin so that the food does not begin to burn or dry out.
- Use the grill tray or roaster for a large joint of meat and for cooking methods that involve adding a lot of liquid to the joint.
- For best results, leave meat to marinate overnight and remove the marinade before roasting or grilling, e.g. using the back of a knife or a spoon. Otherwise, the herbs and spices will burn.
- If the joint of meat has become too dark in colour and the skin is burnt in places, choose a lower temperature the next time you cook a joint and check the rack level.
- If the joint is cooked but the sauce is slightly burnt, use a smaller roaster the next time you cook a joint and add more liquid. If the sauce is too watery, use a larger roaster and add less liquid.

Dish	Accessories	Level	Temperature in °C	Heating function	Cooking time in min.	Comments
Beef						
Joint of beef (1.5 kg)	Glass dish/ grill tray	2 (3)	180		90 - 120*	
Rump steak, medium rare (450 g)	Glass dish/ grill tray	2 (3)	200		30	Core temperature 65 °C.
		2 (3)	200		40	Core temperature 65 °C. No need to preheat; do not open appliance door.
Roast beef/sirloin steak (1 kg) – rare	Glass dish/ grill tray	2 (3)	230 / 180		25 - 35**	Recipe tip: Delicious with Béarnaise sauce or cold cut with remoulade and roast potatoes.
– medium rare	Glass dish/ grill tray	2 (3)	230 / 180		35 - 45**	
– well done	Glass dish/ grill tray	2 (3)	230 / 180		50 - 60**	
Pork						
Fillet of pork, whole	Glass dish/ grill tray	2 (3)	230 / 180		20 - 25**	Recipe tip: Marinate in a mixture of oil, garlic and parsley.

* First, sear on all sides in a frying pan/roasting dish on the hob.

** Sear the meat at a high temperature; after 15 - 20 minutes, set the lower temperature.

*** Cook the meat at a low temperature; set it to cook at the higher temperature for the last 15 - 20 minutes.

Dish	Accessories	Level	Temperature in °C	Heating function	Cooking time in min.	Comments
Fillet of pork (260 g)	Glass dish/ grill tray	2 (3)	180	✿	30	Core temperature 70 °C.
		2 (3)	180	✿ ^e	40	Core temperature 70 °C. No need to preheat; do not open appliance door.
Pork medallions	Glass dish/ grill tray	2 (3)	180	✿	12 - 15*	Recipe tip: Just before you take them out of the oven, add a knob of butter and a sprig of rosemary to the glass dish/grill tray and cook it all together for a little longer in the oven.
Joint of pork – leg (1 kg)	Glass dish/ grill tray	2 (3)	230 / 180	✿	45 - 50**	
Joint of pork – neck (1.5 kg)	Glass dish/ grill tray	2 (3)	230 / 180	✿	85 - 95**	
		2 (3)	230 / 180	✿ ^e	70 - 80**	
Joint of pork with crispy skin/roast pork with crackling (1.5 kg)	Wire rack + grill tray	2 (3)	180 / 200	✿ ^e	60 - 70***	
Pork knuckle	Wire rack + grill tray	2 (3)	150 / 200	✿ ^e	40 - 45***	Score the skin diagonally in both directions so that it is cross-hatched. This makes it nice and crispy.
Smoked pork (1 kg)	Glass dish/ grill tray	2 (3)	180 / 160	✿	50 - 60**	
Rolled roasting joint	Glass dish/ grill tray	2 (3)	230 / 180	✿	65 - 70***	
		2 (3)	230 / 180	✿ ^e	75 - 80***	
Veal						
Joint of veal (1.5 kg)	Glass dish/ grill tray, roasting dish	2 (3)	180	✿	50 - 60*	
Veal knuckle	Glass dish/ grill tray, roasting dish	2 (3)	150 / 180	✿ ^e	50 - 60***	
Veal loin	Glass dish/ grill tray, roasting dish	2 (3)	160 - 170	✿	20	
Stuffed breast of veal	Glass dish/ grill tray, roasting dish	2 (3)	120 - 130	✿	120	
Game						
Wild boar joint	Glass dish/ grill tray, roasting dish	2 (3)	170	✿	60 - 90*	Recipe tip: Marinate overnight in a mixture of oil, garlic, mustard and herbes de Provence.
Leg of roe venison	Glass dish/ grill tray, roasting dish	2 (3)	170 - 180	✿	60 - 80	
Saddle of venison	Glass dish/ grill tray, roasting dish	2 (3)	165 - 175	✿	20	
		2 (3)	165 - 175	---	20 - 25	
Saddle of rabbit	Glass dish/ grill tray, roasting dish	2 (3)	180	✿	15 - 25*	Recipe tip: Marinate in a mixture of garlic, rosemary, olive oil and high-quality balsamic vinegar.

* First, sear on all sides in a frying pan/roasting dish on the hob.

** Sear the meat at a high temperature; after 15 - 20 minutes, set the lower temperature.

*** Cook the meat at a low temperature; set it to cook at the higher temperature for the last 15 - 20 minutes.

Dish	Accessories	Level	Temperature in °C	Heating function	Cooking time in min.	Comments
Leg of lamb – medium rare	Glass dish/ grill tray, roasting dish	2 (3)	180 - 190	✿	100*	Recipe tip: Marinate overnight in a mixture of olive oil, garlic, rosemary and sliced lemon.
– well done	Glass dish/ grill tray, roasting dish	2 (3)	180 - 190	✿	120*	
Lamb knuckle	Glass dish/ grill tray, roasting dish	2 (3)	180 - 200	✿	35 - 45	
Miscellaneous						
Meatballs (80 g per ball)	Baking tray + grease- proof paper	2 (3)	200	✿	30 - 35	The flatter the meatballs, the faster they cook. Easy to make in large quantities.
Meatballs, lightly fried (80 g per ball)	Baking tray + grease- proof paper	2 (3)	200	✿	20	Nicely browned yet juicy meatballs: First, fry them lightly in the frying pan, then put them in the oven.
Meatballs (25 g per ball)	Baking tray + grease- proof paper	2 (3)	200	✿	25 - 30	Recipe tip: Easy to make into a meal, e.g. meatballs with tomato sauce, Swedish meatballs and Königsberger Klopse (Prussian meatballs in a white sauce with capers).
Meatballs, lightly fried (25 g per ball)	Baking tray + grease- proof paper	2 (3)	200	✿	15	Recipe tip: Place meatballs made from minced lamb or rabbit on skewers and serve with mint yoghurt or fig mustard.
Meat loaf, fresh (700 g)	Wire rack + grill tray	2 (3)	160	✿	60	Use a core temperature probe (core temperature 67 °C).
Rashers of bacon (oven-cooked bacon), thin	Baking tray + grease- proof paper	3 (4)	180	✿	8 - 10	Once you have taken the bacon out of the oven, place it on some kitchen towel to soak up the fat.
Rashers of bacon (oven-cooked bacon), thick	Baking tray + grease- proof paper	3 (4)	190	✿	8 - 12	
Stuffed peppers with minced meat	Ovenproof dish/roast- ing dish	2 (3)	175	✿	55 - 60	Recipe tip: Stuff with minced meat and cook in tomato sauce.

* First, sear on all sides in a frying pan/roasting dish on the hob.

** Sear the meat at a high temperature; after 15 - 20 minutes, set the lower temperature.

*** Cook the meat at a low temperature; set it to cook at the higher temperature for the last 15 - 20 minutes.

Poultry

- Use the core temperature probe so that you can monitor the core temperature more easily. Insert this between the belly and the thigh, rather than in the middle (cavity). Further information and optimum target temperatures can be found in the section entitled → "Core temperature probe" on page 24.
- Poultry will turn out particularly crispy and brown if you baste it towards the end of the roasting time with butter, salted water, drained fat or orange juice.
- When cooking duck or goose, pierce the skin underneath the wings to allow the fat to run out.
- Use a roaster or another heat-resistant baking dish or tin for dishes that require a lot of liquid to be added to the roast. The same applies if a lot of fat is likely to drain from the food, e.g. roast goose.















Meal	Accessories	Level	Temperature in °C	Type of heating	Cooking time in min.	Comments
Duck, whole (1.5 - 2 kg)	Wire rack + Grill tray/ roasting dish	2 (3)	160/180	---	75*	Recipe tip: Stuff with oranges, apples or dried fruit.
Duck breast	Roasting dish/oven-proof dish	2 (3)	160	✿	25 - 35	Score the skin diagonally in both directions so that it is cross-hatched.
Goose, whole (5 kg)	Wire rack + Grill tray/ roasting dish	2 (3)	160/190	✿	110 - 130*	Recipe tip: Stuff with apples, onions and marjoram, and pin the opening closed with a cocktail stick or similar sharp item.
		2 (3)	160/190	---	110 - 130*	
Turkey, whole	Wire rack + Grill tray/ roasting dish	2 (3)	160/190	✿	120 - 180*	
		2 (3)	160/190	---	120 - 180*	
Chicken, whole (1 kg) (in accordance with EN 60350-1)	Wire rack + Grill tray	2 (3)	190	✿	70 - 80	Preheating.
		2 (3)	190	☼	70 - 80	
Chicken drumstick	Wire rack + Grill tray	3 (4)	220	☼	30**	Recipe tip: Asian marinade with soy sauce, honey, chilli, garlic, ginger, cumin, sweet lime zest and coriander.
		3 (4)	220	☼	30**	
Chicken leg	Wire rack + Grill tray	3 (4)	220	☼	30**	After the leg is turned, the side with more skin should be at the top. This makes it nice and crispy. Marinate in a mixture of oil, rosemary, sliced lemon and garlic
		3 (4)	220	☼	30**	
Chicken breast	Wire rack + Grill tray	2 (3)	200	✿	20 - 25	Recipe tip: Rub with tandoori paste before cooking.
		2 (3)	200	✿ ^e	50	No need to preheat; do not open appliance door.
Chicken nuggets, frozen	Baking tray + Grease-proof paper	2 (3)	200	✿	15**	
Quail breast	Baking tray	3 (4)	220	☼	10 - 12	Baste with oil and seasoning/spices, e.g. paprika, thyme, juniper and garlic.
Quail, whole (150 g per bird)	Wire rack + Grill tray	3 (4)	200	☼	20 - 25	Baste with oil and seasoning/spices, e.g. paprika, thyme, juniper and garlic.

* Cook the meat at a low temperature; set it to cook at the higher temperature for the last 15 - 20 minutes.

** Turn food after half the cooking time has elapsed.

Grilling and roasting

- Do not grill food with the oven door open.
- For grilling, use the grill tray with the wire insert (depending on the model, this may be an accessory or an optional accessory). Pour approximately 100 ml water into the grill tray; this will catch the meat juices so that the oven stays clean. If you pour in too much water, this may alter the cooking result because too much steam will be produced.
- The pieces of food to be grilled should be of roughly the same thickness (at least 2 to 3 cm). This will allow them to brown evenly and remain succulent and juicy. Never add salt to meat before grilling it. Place the food to be grilled directly on the wire rack.
- If you use wooden skewers, they may char. To prevent this, shorten them as far as possible, leave them to soak in water overnight before skewering the ingredients or use metal skewers.
- For small quantities, use the energy-saving "Compact grill" heating function. With this heating function, only the centre part of the grill is heated. Place the food to be grilled in the centre of the wire rack.

Dish	Accessories	Level	Recommended temperature in °C	Type of heating	Cooking time (mins)	Comments
Pork belly, sliced	Wire rack + grill tray	2 (3)	230		18–20*	
		2 (3)	230		18–20*	
Shish kebab	Wire rack + grill tray	3 (4)	190		16*	
Bratwurst (German sausage)	Wire rack + grill tray	3 (4)	270		10*	
Merguez sausage	Wire rack + grill tray	3 (4)	250		12*	
Spare ribs, pre-cooked	Wire rack + grill tray	3 (4)	200–220		24*	
		3 (4)	200–220		24*	
Spare ribs, raw	Wire rack + grill tray	3 (4)	220		40*	Recipe tip: Place in a mixture of oil, mustard, balsamic vinegar, honey, garlic, Worcester sauce, tomato purée and Tabasco sauce.
		3 (4)	220		30*	
Chicken satay	Wire rack + grill tray	3 (4)	250		10–14*	Serve with satay sauce.
Halloumi cheese (grill cheese)	Wire rack + grill tray	3 (4)	250		5–8	Halloumi is a semi-hard cheese used in Turkish and Greek cooking. It is excellent grilled.
Toasting bread (Appliance width: 60 cm)	Wire rack	3	200		2:30–3	Preheat for up to 5 minutes. Stay by the appliance so that the toast does not brown too much. Do not grill food with the oven door open.
Toasting bread (Appliance width: 76 cm)	Wire rack	4	200		2–2:30	Preheat for up to 5 minutes. Stay by the appliance so that the toast does not brown too much. Do not grill food with the oven door open.
Toast Hawaii	Baking tray + grease-proof paper	3 (4)	190		8–10**	
Croque monsieur	Baking tray + grease-proof paper	3 (4)	190		8–11**	

* Turn the food halfway through cooking.

** Brown to the level you require.

Dish	Accessories	Level	Recommended temperature in °C	Type of heating	Cooking time (mins)	Comments
Croutons	Baking tray	2 (3)	180	✿	15*	Recipe tip: Mix fresh white bread with olive oil, garlic and rosemary leaves. Avoid using too much oil and wait until you are ready to serve before pouring it on; otherwise, the bread cubes will become saturated. Turn several times.
Browning meringue	Springform cake tin	2 (3)	220–250	~~~~~	4–5**	Stay by the appliance so that the meringue does not brown too much.
Prunes wrapped in bacon	Baking tray + grease-proof paper	3 (4)	200	~~~~~	8–10	Equally delicious with dates or apricots.

* Turn the food halfway through cooking.
** Brown to the level you require.

Baked items

- We recommend using dark-coloured metal baking tins as these absorb heat more effectively. Place the baking tin in the centre of the wire rack.
- If you are baking tray bakes without greaseproof paper, lightly grease the baking tray beforehand.
- Small baked items, e.g. cream puffs, biscuits and puff pastry parcels, can be baked on two levels, 1+3 or 2+4.
- If you are baking on more than one level, it is normal for food on baking trays placed in the oven at the same time to be ready at different times. Leave the food on the baking trays lower down in the oven to cook for a little longer, or place them in the appliance earlier next time.
- Before cutting the baked items, leave them to cool on a wire rack.
- If the baked items are too dark on the bottom, place them a level up and select a lower temperature.
If the baked items are too dark on the top, place them a level down, select a lower temperature and extend the baking time a little.
- If the cake is too dry, set the temperature a little higher. If the cake remains uncooked in the middle, set a lower temperature.
Baking times cannot be reduced by setting a higher temperature; it is better to set the temperature a little lower.
- If the cake collapses, use less liquid or set the temperature 10 °C lower. Do not open the oven door too soon.
- If the cake only rises in the middle, grease the sides of the baking tin.
- Do not remove the biscuits from the baking tray; place the baking tray back into the hot oven for a short period and remove the biscuits whilst they are still hot.
- If the cake does not come away from the tin when you are trying to turn it out, carefully slide a knife around the sides to loosen it. Turn the cake tin upside down again and cover it several times with a cold, wet cloth. Next time, grease the tin well and sprinkle some bread crumbs into it.
- In addition, always follow the manufacturer's instructions for pre-baked and frozen products.

Dish	Accessories	Level	Temperature in °C	Type of heating	Cooking time (mins)	Comments
Cakes						
Cheesecake	Springform cake tin	1 (2)	160–165	☛	70–75	
		1 (2)	160–165	---	70–75	
		1 (2)	160–165	☛	85–90	
		1 (2)	160–165	---	80–90	
		1 (2)	160–165	☛	40–45	Low-cheese cheesecake with 50% quark mixture.
Sponge cake	Springform cake tin	2 (3)	160–170	☛	50–60	
		2 (3)	160–170	---	50–60	
Loaf cake	Loaf tin	2 (3)	160–170	☛	60–65	To ensure even browning, place the tin lengthways in the cooking compartment.
		2 (3)	160–170	---	55–60	
Bundt cake, ring cake	Ring cake tin	1 (2)	165	☛	30	Recipe tip: Stick to a traditional Bundt cake recipe or add bacon and walnuts.
		1 (2)	170	☛ ^e	55	No need to preheat; do not open the appliance door.
Tray bakes	Baking tray	2 (3)	165–170	☛	20–30	Lightly grease the baking tray.
		2 (3)	165–170	---	40–50	
Swiss roll	Baking tray + greaseproof paper	2 (3)	190	☛	6	Turn it out while still hot onto a piece of greaseproof paper sprinkled with sugar, then roll it up.
Sponge base	Springform cake tin	2 (3)	165–175	☛	30–35	Line a springform cake tin with greaseproof paper.
Yeast tray bakes	Baking tray	2 (3)	165	☛	30–35	Recipe tip: Top with plums, figs or onion and ham.
		2 (3)	165	---	30–35	
Fruit flan with shortcrust pastry	Tart tin or dish	2 (3)	165	☛	40–50	Recipe tip: Top with strawberries or apricots and marzipan.
		2 (3)	170	---	40–50	
		2 (3)	165	☛	45–55	
Tart	Tart tin or dish	2 (3)	190	☛	30–40	French flan with a shortcrust pastry base, e.g. tarte aux pommes, tarte tatin, tarte au chocolat and tarte au citron.
		2 (3)	190	---	30–40	
		2 (3)	190	☛	40–45	
		2 (3)	190	---	45–50	For light-coloured tart tins or dishes.
Strudel made from puff pastry	Baking tray + greaseproof paper	2 (3)	200	☛	20–25	Recipe tip: Fill with custard and cherries or apples.
Apple pie (in accordance with EN60350-1)	20 cm springform cake tin	2	160**	☛	90–105	Preheat
		(Appliance width: 60 cm)	1	160**	---	90–100
Apple pie (in accordance with EN60350-1)	20 cm springform cake tin	3	160**	☛	85–100	Preheat
		(Appliance width: 76 cm)	2	160**	---	100–110

* Preheat the appliance to the specified temperature. Turn the temperature down to the second specified temperature when placing the food in the oven.

** Deactivate the "Rapid heating" function in the basic settings → "Basic settings" on page 32

Dish	Accessories	Level	Temperature in °C	Type of heating	Cooking time (mins)	Comments
Water sponge cake (in accordance with EN60350-1)	26 cm springform cake tin	2	160**	☛	22–30	Preheat
(Appliance width: 60 cm)	26 cm springform cake tin	2	160**	---	20–30	Preheat
Water sponge cake (in accordance with EN60350-1)	26 cm springform cake tin	3	160**	☛	22–30	Preheat
(Appliance width: 76 cm)	26 cm springform cake tin	3	160**	---	25–30	Preheat
Small baked items						
Cream puffs, eclairs	Baking tray + greaseproof paper	2 (3)	180	☛	35	Recipe tip: Fill with vanilla custard, chocolate mousse, fruit cream or mocha cream.
		2 (3)	180	---	40	
		2 (3)	180	☛	35	
Biscuits, piped cookies	Baking tray	2 (3)	160–170	☛	15	
		2 (3)	160–170	---	18	
Small baked puff-pastry items	Baking tray + greaseproof paper	2 (3)	200	☛	15–20	
Filled puff pastry parcels	Baking tray + greaseproof paper	3 (4)	200	☛	15	Recipe tip: Fill with ham and cheese or apples and raisins.
Puff pastry	Baking tray + greaseproof paper	3 (4)	200	☛	15	Recipe tip: With sesame seeds, poppy seeds, icing.
Puff pastry twists	Baking tray + greaseproof paper	3 (4)	200	☛	15	Recipe tip: Fill with cheese, ham, or nuts.
Small pastries	Baking tray + greaseproof paper	2 (3)	200	☛	15–20	Recipe tip: Serve with custard and/or fruit.
Waffle biscuits	Baking tray + greaseproof paper	2 (3)	140	☛	8–10	Shape the waffle biscuits whilst they are still hot, e.g. into ice cream cones or small rolls for dessert.
Breadsticks	Baking tray + greaseproof paper	2 (3)	160	☛	30	Sprinkle with sea salt, rosemary, curry powder, sesame seeds or caraway seeds.
Cookies (20 g each)	Baking tray + greaseproof paper	2 (3)	175	☛	12–14	With chocolate, raisins, nuts or lemon.

* Preheat the appliance to the specified temperature. Turn the temperature down to the second specified temperature when placing the food in the oven.

** Deactivate the "Rapid heating" function in the basic settings → "Basic settings" on page 32

Dish	Accessories	Level	Temperature in °C	Type of heating	Cooking time (mins)	Comments
Brownies	Baking tray + greaseproof paper	2 (3)	120	✿	60	Cut into squares or rectangles once baked. The low temperature means that the brownies will stay gooey in the middle.
		2 (3)	180	✿ ^e	40–45	No need to preheat; do not open the appliance door.
Muffins	Muffin tray/paper cases	2 (3)	160	✿	25–30	With chocolate, nuts or raisins.
		2 (3)	175	---	25–30	
		2 (3)	160–165	---	25–30	
Small cakes (in accordance with EN60350-1) (Appliance width: 60 cm)	Glass tray	2	150**	✿	25–30	Preheat
	Baking tray	3	150**	✿	28–32	Preheat
	Glass tray	1				Applies to baking on two levels
Small cakes (in accordance with EN60350-1) (Appliance width: 76 cm)	Glass tray	3	150**	✿	26–32	Preheat
	Baking tray	4	150**	✿	30–32	Preheat
	Glass tray	2				Applies to baking on two levels
Piped cookies (in accordance with EN60350-1) (Appliance width: 60 cm)	Baking tray	2	140**	✿	35–40	Preheat
	Baking tray	3	140**	✿	35–40	Preheat
	Glass tray	1				Applies to baking on two levels
Piped cookies (in accordance with EN60350-1) (Appliance width: 76 cm)	Baking tray	2	140**	---	26–30	Preheat
	Baking tray	3	140**	✿	30–35	Preheat
	Baking tray	4	140**	✿	30–40	Preheat
Glass tray	2					Applies to baking on two levels
	Baking tray	3	140**	---	30–35	Preheat

Bread, bread rolls

Multigrain bread	Baking tray + greaseproof paper	2 (3)	200 / 170*	✿	40–50	
		2 (3)	200 / 170*	---	40–50	
		2 (3)	200 / 165*	---	45–50	
Sourdough bread	Baking tray	2 (3)	200 / 180*	---	50–60	
Olive and tomato bread	Baking tray	2 (3)	200 / 170*	---	40–50	
Bread in a loaf tin	Loaf tin	2 (3)	175	---	40–45	
Baguette, pre-baked	Baking tray + greaseproof paper	2 (3)	220	---	10–12	
Ciabatta, pre-baked	Baking tray + greaseproof paper	2 (3)	190	---	12–14	
		2 (3)	180	✿	12–14	
Flatbread	Baking tray + greaseproof paper	2 (3)	200	✿	15–20	The cooking time depends on the size and thickness of the flatbread.
		2 (3)	210	---	15–20	

* Preheat the appliance to the specified temperature. Turn the temperature down to the second specified temperature when placing the food in the oven.

** Deactivate the "Rapid heating" function in the basic settings → "Basic settings" on page 32

Dish	Accessories	Level	Temperature in °C	Type of heating	Cooking time (mins)	Comments
Focaccia	Baking tray + greaseproof paper	2 (3)	210	---	15–20	Top with various ingredients, e.g. herbs, sea salt, olives, anchovies, onion, ham, tomatoes or cheese.
Garlic/herb baguette	Baking tray + greaseproof paper	2 (3)	200	---	8–10	
Strudel made from puff pastry	Baking tray + greaseproof paper	2 (3)	200	✿	20–25	Recipe tip: Fill with sheep's cheese and feta cheese.
Plaited loaf	Baking tray + greaseproof paper	2 (3)	165	✿	20	No need to preheat; do not open the appliance door.
		2 (3)	170	✿ ^e	30–35	
Bread rolls, pre-baked	Baking tray + greaseproof paper	2 (3)	210	---	8–10	
		2 (3)	200	✿	8–10	
Bread rolls, frozen	Baking tray + greaseproof paper	2 (3)	180	✿	10–12	
		2 (3)	200	---	10–12	
Bread rolls, fresh (50 g each)	Baking tray + greaseproof paper	2 (3)	250 / 200*	---	15–20	
Baked items made from lye-dipped yeast dough, frozen	Baking tray + greaseproof paper	2 (3)	200	✿	10–12	
Croissants, frozen	Baking tray + greaseproof paper	2 (3)	170	---	15–25	

* Preheat the appliance to the specified temperature. Turn the temperature down to the second specified temperature when placing the food in the oven.

** Deactivate the "Rapid heating" function in the basic settings → *"Basic settings" on page 32*











Dough proving (leaving to rise)

- Place the bowl containing the dough onto the wire rack. Select the "Dough proving" heating function.
- For large quantities, e.g. bread, set the temperature to 38 - 40 °C. This helps the dough to rise evenly from the centre to the edges.
- For small quantities of dough, e.g. sweet pastry swirls and bread rolls, you can set a temperature of 40 - 45 °C.
- The cooking time specified is intended as a guide only. Leave the dough to rise until it has doubled its volume.
- If the dough does not rise, this means that either you have not used sufficient yeast or you have not kneaded the dough sufficiently.

Dish	Accessories	Level	Temperature in °C	Heating function	Cooking time in min.	Comments
Dough mixture	Bowl	2 (3)	38		25 - 45	e.g. yeast dough, natural fermentation starter, sourdough, yeast dumplings

Desserts

- Oven-cooked desserts are very easy to prepare – you just have to put it in the oven. This preparation method is useful for relatively large quantities, for example if you have guests.
- Oven-cooked desserts are generally eaten warm, and are particularly enjoyable during the cooler months.

Dish	Accessories	Level	Temperature in °C	Heating function	Cooking time in min.	Comments
Apple crumble	Ovenproof dish	2 (3)	200		35 - 40	Apple bake with a crumble topping; equally delicious with berries or mirabelles.
		2 (3)	200		25 - 30	For soft apple varieties.
		2 (3)	200		25 - 30	For firm apple varieties.
Baked apple	Ovenproof dish	2 (3)	190 - 200		20 - 30	Recommendation: Use cooking apples, e.g. Boskop. These are particularly well suited for cooking and baking. Summer version: Stuff with ricotta cheese, lemon, honey, cardamom, vanilla and pine nuts.
Compote	Glass dish/ grill tray	2 (3)	160 - 180		30 - 40	e.g. apricots or a variety of berries
		2 (3)	200		30 - 40	Do not add any liquid; stir thoroughly several times. Refine with honey, fresh vanilla or cinnamon.
Clafoutis	Ovenproof dish	2 (3)	190		30 - 35	French dessert: Traditionally made with cherries; equally delicious with mirabelles or berries.
		2 (3)	200		55	No need to preheat; do not open appliance door.
Sweet bake	Ovenproof dish	2 (3)	160 - 180		30 - 40	e.g. semolina, quark or rice pudding
Bread and butter pudding, Kirschenmichel (German bread and butter pudding with sour cherries)	Ovenproof dish	2 (3)	150		50 - 55	e.g. with cherries or apricots

Dish	Accessories	Level	Temperature in °C	Heating function	Cooking time in min.	Comments
Topfenpalatschinken (baked sweet pancakes with a quark filling)	Ovenproof dish	2 (3)	180 - 190	✦	8 - 10	Austrian speciality: Pancakes filled with quark and raisins, topped with cream and grilled.
Meringue	Baking tray + grease-proof paper	2 (3)	100	✦	150	When dividing up the mixture, make sure that the portions are spread as thinly as possible so that the mixture dries out well.

Defrosting

- To defrost food, use the "Defrost" heating function.
- The defrosting times specified are intended as a guide only. The defrosting time depends on the size, weight and shape of the frozen food. This reduces the defrosting time.
- Slide the wire rack with the frozen food into the second rack level (into the third rack level if there are five rack levels). Slide the glass dish/grill tray underneath to catch any liquid that drips down as the food defrosts.
- Remove the food from the packaging before defrosting.
- Do not defrost more food than you intend to eat on this occasion.
- Remember: Once defrosted, food may not keep for as long and spoils faster than fresh food. Prepare defrosted food immediately and cook it thoroughly.

- After half the defrosting time has elapsed, turn the meat or fish. Break up frozen clumps of food comprising many pieces, e.g. berries and pieces of meat. Fish does not need to be fully defrosted; it is sufficient to defrost it until the surface is soft enough for seasoning/spices to stick.
- The oven is not suitable for defrosting whole chickens or joints of meat as this takes a very long time. Steam ovens and combination steam ovens can be used to defrost this kind of food much more quickly.

Warning – Health risk!

When defrosting food from animal sources, you must remove the liquid that escapes during defrosting. It must never come into contact with other food. Germs could be transferred.

Slide the glass dish/grill tray under the food and into the appliance. Pour away the liquid that collects in the dish or tray as the meat and poultry defrosts. Then clean the sink and rinse with plenty of water. Clean the glass dish/grill tray in hot soapy water or in the dishwasher.

After defrosting, operate the oven for 15 minutes at 180 °C in the "Hot air" (fan-oven) setting.

Dish	Accessories	Level	Temperature in °C	Heating function	Cooking time in min.	Comments
Berries (500 g)	Glass dish/grill tray	2 (3)	50 - 55	* ◊	25 - 30	
Vegetables (500 g)	Glass dish/grill tray	2 (3)	50 - 55	* ◊	30 - 50	The defrosting time depends on the portions. Small vegetables, such as peas and beans, defrost more quickly than frozen spinach blocks and cauliflower florets.
Chicken thighs (200 g per thigh)	Wire rack	2 (3)	50 - 55	* ◊	45 - 50	
Fish fillet (150 g per fillet)	Wire rack	2 (3)	45 - 50	* ◊	45 - 50	
Prawns	Wire rack	2 (3)	45 - 50	* ◊	20 - 25	

Preserving

- Cook food as soon as possible after purchase or after it has been harvested. Prolonged storage reduces the vitamin content and means that food is on the verge of fermenting.
- Only use fruit and vegetables that are in good condition.
- The oven is not suitable for preserving meat.
- Carefully check and clean the preserving jars, rubber sealing rings, clips and springs.
- Place the preserving jars in a heat-resistant vessel containing water. Make sure that they do not touch. The water level must reach at least three quarters of the way up to the top of the contents of the jars.
- Once the cooking time has elapsed, open the cooking compartment door. Do not remove the preserving jars from the cooking compartment until they have completely cooled down.
- Store the preserves in a cool, dark and dry place, e.g. in a pantry. Once the jars have been opened, consume the contents quickly and store in the refrigerator.

Dish	Accessories	Level	Temperature in °C	Heating function	Cooking time in min.	Comments
Fruit	Wire rack	1 (2)	150 - 160	---	35 - 40	In sealed jars
Vegetables	Wire rack	1 (2)	190 - 200	---	60 - 120	In sealed jars

Disinfecting

- Before you begin preserving the food, the glasses should be disinfected in the oven to prevent the food from spoiling. This is the only way to ensure that preserves keep for a relatively long time and can be stored outside of the refrigerator.
- Disinfect the empty jars at 100 °C for at least 20 minutes in the "Hot air" (fan-oven) setting. The lids and rubber preserving seals for the jars can be disinfected at the same time in boiling water to avoid them drying out in the dry heat of the oven.

Dish	Accessories	Level	Temperature in °C	Heating function	Cooking time in min.	Comments
Disinfecting	Wire rack	2 (3)	100	✚	20 - 25	Preserving jars, baby bottles

Drying

- Drying is a method of preserving food in which up to 50% of the liquid contained in the food is removed by exposing it to dry heat. This also makes the flavour more intense.
- The thicker the food, the longer the drying process lasts. The quickest way to dry food – which is also the method that saves the most energy – is to cut it into slices.
- Place the prepared food onto a wire rack or baking tray covered with greaseproof paper. Turn the food from time to time during the drying process.
- The duration depends on the thickness of the food and on the natural level of moisture in the food, i.e. tomatoes take longer to dry out than mushrooms.
- If you want to dry food in the oven on two levels at the same time, use levels 1 and 3 (or 2 and 4).

Dish	Accessories	Level	Temperature in °C	Heating function	Cookingtime in hours	Comments
Sliced mushrooms	Wire rack + greaseproof paper	2 (3)	50 - 60	✚	3 - 4	
Apple rings	Wire rack + greaseproof paper	2 (3)	50 - 70	✚	5 - 8	

Dish	Accessories	Level	Temperature in °C	Heating function	Cookingtime in hours	Comments
Quartered tomatoes	Wire rack + greaseproof paper	2 (3)	60 - 70	✚	7 - 8	Core the tomatoes to avoid an extended drying time.
Herbs	Wire rack + greaseproof paper	2 (3)	50 - 60	✚	1½ - 2	e.g. chives, parsley and sage

Baking stone

- You will need a baking stone and heating element – these are optional accessories.
- Whether you are baking crispy pizza or fresh bread, using the baking stone will produce results that are comparable to (or even exceed) those you would get from a large stone oven because you are able to control the baking temperature precisely.
- Depending on the size, you can place several pizzas, bread rolls or other baked items on the baking stone at once.
- You can bake several pizzas in succession. This may increase the baking time per pizza by approx. 1 - 3 minutes.
- We recommend that you use a core temperature probe when baking bread. Wait 10 - 15 minutes after baking has begun before inserting the probe into the thickest part of the bread. The sensor measures the internal temperature of the baked goods and switches the oven off when the set core temperature has been reached.
- When dough is baked, it needs to be able to expand without the surface breaking apart. This can be achieved by pricking it several times with a fork or by making a cut with a knife.
- The temperatures and times given in the cooking table are guidelines. Always follow the manufacturer's instructions for pre-cooked and frozen products in addition to using this table.

Meal	Accessory/ies	Level	Temperature in °C	Type of heating	Cooking time (mins)	Comments
Bread rolls, fresh (50 g each)	Baking stone	1	250 / 200*	☰	15 - 20	
Flatbread	Baking stone	1	210	☰	15	The cooking time depends on the size and thickness of the flatbread
Foccacia	Baking stone	1	210	☰	15	Top with various ingredients, e.g. herbs, sea salt, olives, anchovies, onion, ham, tomatoes or cheese.
Multigrain bread	Baking stone	1	175	☰	45	
Sourdough bread	Baking stone	1	250 / 200*	☰	50 - 60	
Olive and tomato bread	Baking stone	1	175	☰	45	
Pizza, fresh	Baking stone	1	275	☰	5 - 8	The cooking time varies depending on the type and thickness of the dough and topping.
Pizza, frozen	Baking stone	1	230	☰	8 - 10	The cooking time varies depending on the thickness of the dough. Follow the manufacturer's instructions.
Tarte flambée, fresh	Baking stone	1	300	☰	3 - 4	Recipe tip: Traditional or with goat's cheese, Parma ham, figs and spring onions.
Tarte flambée, frozen	Baking stone	1	250	☰	4 - 5	

* Preheat the appliance to the specified temperature. Turn the temperature down when placing the food in the oven.

Roasting dish

- You will need a roaster, pull-out system and heating element – these are optional accessories.
- In the roaster, you can also easily cook large pieces of meat and braise large quantities.
- Food is easy to prepare and can be kept warm in the oven. Your kitchen will look tidy, the hob will not be dirty, and fewer cooking smells will be produced as the dish is being cooked in the oven.
- The non-stick coating enables you to roast using very little fat.

Tip: Rather than adding the fat to the roaster, brush oil over the meat. This will ensure that the heat is transferred directly to the meat.

- Cooking liquids reduce down quickly. Make sure that there is always sufficient cooking liquid. For a cooking time of 30 minutes, add approx. ½ l of liquid.
- When cooking in a sauce, always ensure that the sauce remains runny and add cooking liquid.
- In addition, follow the instructions in the user manual for the roaster.

Dish	Accessories	Level	Temperature in °C	Heating function	Cookingtime in min.	Comments
Chicken breast	Roasting dish	1	200	<input type="checkbox"/>	Initial roasting + 15 - 20	Before you place the food in the roasting dish, heat it up using the "Roasting function". Then insert the core temperature probe.
Beef goulash	Roasting dish	1	220 / 130 - 140*	<input type="checkbox"/>	Initial roasting + 60 - 120	Roast the onion and meat initially; use the "Roasting function" for this. Pour in liquid and turn the temperature back down; cook for 60 - 120 minutes depending on the type of meat.
Ossobuco	Roasting dish	1	220 / 140*	<input type="checkbox"/>	Initial roasting + 60 - 90	Roast the meat and vegetables initially; use the "Roasting function" for this. Pour in liquid and turn the temperature back down; cover and cook for a further 60 - 90 minutes. Turn the sliced shanks once.
Viennese boiled beef	Roasting dish	1	220 / 130*	<input type="checkbox"/>	Initial roasting + 210 - 240	Roast the onion halves for a short time, add the vegetables and roast briefly, then fill the dish with liquid. Bring the vegetable water to the boil, season and add the Viennese boiled beef. The meat should be completely covered in liquid. Place the lid on the roasting dish and continue cooking at a temperature of 130 °C.
Venison ragout	Roasting dish	1	220 / 130 - 140*	<input type="checkbox"/>	Initial roasting + 60 - 100	Roast the meat and other ingredients initially; use the "Roasting function" for this. Pour in liquid and turn the temperature back down; cook for 60 - 100 minutes depending on the type of meat and the size of the pieces of meat.
Roulades	Roasting dish	1	220 / 120*	<input type="checkbox"/>	Initial roasting + 60 - 90	Roast the roulades initially in portions; use the "Roasting function" for this.
Tortilla	Roasting dish	1	175	<input type="checkbox"/>	Initial roasting + 10 - 15	Roast all the ingredients initially in the roasting dish, apart from the eggs; then pour the egg mixture over the top and continue cooking until the tortilla is firm.
Farmers' omelette	Roasting dish	1	175	<input type="checkbox"/>	Initial roasting + 10 - 15	Roast all the ingredients initially in the roasting dish, apart from the eggs; then pour the egg mixture over the top and continue cooking until the farmers' omelette is firm.

* Roast initially at a high temperature; to continue cooking, turn the temperature back down.

Dish	Accessories	Level	Temperature in °C	Heating function	Cookingtime in min.	Comments
Stuffed peppers, vegetarian	Roasting dish	1	200	<input type="checkbox"/>	30	Recipe tip: Stuff with boiled rice, soft wheat or lentils and onions, cheese, herbs and seasoning/spices.
Chilli con carne	Roasting dish	1	220 / 130*	<input type="checkbox"/>	Initial roasting + 60 - 90	

* Roast initially at a high temperature; to continue cooking, turn the temperature back down.

Acrylamide in foodstuffs

Which foods are affected?

Acrylamide is mainly produced in grain and potato products that are heated to high temperatures, such as crisps, chips, toast, bread rolls, bread, fine baked goods (biscuits, gingerbread, cookies).

Tips for keeping acrylamide to a minimum when preparing food

General	Keep cooking times as short as possible. Cook food until it is golden brown, but not too dark. Large, thick pieces of food contain less acrylamide.
Baking	With hot air at max. 180 °C.
Biscuits	Egg or egg yolk reduces the production of acrylamide. Spread out a single layer evenly on the baking tray.
Oven Chips	Cook at least 400 g at once on a baking tray so that the chips do not dry out.

Gaggenau Hausgeräte GmbH
Carl-Wery-Straße 34
81739 München
GERMANY
www.gaggenau.com

9001329056 (990820)
en

GAGGENAU

