

CX 482

Full surface induction cooktop

Table of contents

Intended use	4	Transfer function	23
		Activation	23
Important safety information	5	Wireless temperature sensor	24
		Preparing and maintaining the wireless temperature sensor	24
Causes of damage	7	Connecting the wireless temperature sensor to the control panel	25
Overview	7	Cleaning	25
		Replacing the battery	26
Environmental protection	8	Declaration of Conformity	26
Tips for saving energy	8		
Environmentally-friendly disposal	8	Cooking sensor mode	27
		Cooking processes with the cooking sensor	27
Induction cooking	8	Benefits	28
Advantages of induction cooking	8	Tips for cooking with cooking sensor mode	28
Cookware	8	Setting the boiling point	28
		Setting procedure	29
Getting to know your appliance	10	Recommended dishes	30
Cooking surface	10		
The control panel	10	Dynamic cooking for an item of cookware	34
Overview of the menus	11	Activation	34
Cooking position display	12	Deactivating	34
Residual heat indicator	12		
		Teppanyaki mode	35
Operating the appliance	13	Suitable cookware	35
First-time use	13	Activation	35
Switching the hob on and off	13	Deactivating	35
Configuring cooking position settings	13		
Chef's recommendations	14	Childproof lock	36
		Activation	36
Dynamic cooking	16	Deactivating	36
Activation	16	Childproof lock	36
Deactivating	16		
		Pause function	36
Professional cooking	17	Activation	36
Activation	17	Deactivating	36
Deactivating	18		
		Automatic safety cut-out	36
Time-setting options	18		
Cooking timer	18	Basic settings	37
Stopwatch function	19	To go to the basic settings	38
Short-term timer	20		
		Home Connect	38
Booster function for pots	21	Connection to your home network	38
Activating	21	Home Connect settings	41
Deactivating	21	Software update	43
		Remote diagnostics	43
Booster function for pans	22	About data protection	44
Recommendations for use	22	Declaration of Conformity	44
Activating	22		
Deactivating	22		
Keep warm function	23		
Activating	23		
Deactivating	23		

Hood control	44
Setting up	45
Disconnecting from the network	45
Control the hood via the hob	46
Ventilation control settings	47
Cleaning	48
Hob	48
Hob surround	48
Frequently Asked Questions (FAQ)	49
Trouble shooting	52
Warnings and fault messages	52
Tips	52
Demo mode	53
Customer service	54
Product number (E no.) and production number (FD no.)	54

Additional information on products, accessories, replacement parts and services can be found at www.gaggenau.com and in the online shop www.gaggenau.com/zz/store

Intended use

Read these instructions carefully. Please keep the instruction and installation manual, as well as the appliance certificate, in a safe place for later use or for subsequent owners.

Check the appliance after removing it from the packaging. If it has suffered any damage in transport, do not connect the appliance, contact the Technical Assistance Service and provide written notification of the damage caused, otherwise you will lose your right to any type of compensation.

Only a licensed professional may connect appliances without plugs. Damage caused by incorrect connection is not covered under warranty.

This appliance must be installed according to the installation instructions included.

This appliance is intended for private domestic use and the household environment only. The appliance must only be used for the preparation of food and beverages. The cooking process must be supervised. A short cooking process must be supervised without interruption. Only use the appliance in enclosed spaces.

This appliance is intended for use up to a maximum height of 4000 metres above sea level.

Do not use covers. These can cause accidents, for example due to overheating, catching fire or materials shattering.

Only use safety devices or child protection grilles approved by ourselves. Unsuitable safety devices or child protection grilles may result in accidents.

This appliance is not intended for operation with an external clock timer or a remote control.

This appliance may be used by children over the age of 8 years old and by persons with reduced physical, sensory or mental capabilities or by persons with a lack of experience or knowledge if they are supervised or are instructed by a person responsible for their safety how to use the appliance safely and have understood the associated hazards.

Children must not play with, on, or around the appliance. Children must not clean the appliance or carry out general maintenance unless they are at least 15 years old and are being supervised.

Keep children below the age of 8 years old at a safe distance from the appliance and power cable.

When using the Cooking sensor mode, set the cooking position on which you have placed the saucepan with the cooking sensor.

If you wear an active implantable medical device (e.g. a pacemaker or defibrillator), check with your doctor that it complies with Council Directive 90/385/EEC of 20th June 1990, DIN EN 45502-2-1 and DIN EN 45502-2-2, and that it has been chosen, implanted and programmed in accordance with VDE-AR-E 2750-10. If these conditions are satisfied, and if, in addition, non-metal cooking utensils and cookware with non-metal handles are used, it is safe to use this induction hob as intended.

⚠ Important safety information

⚠ Warning – Risk of fire!

- Hot oil or grease ignite very easily. Never leave hot fat or oil unattended. Never use water to put out burning oil or fat. Switch off the hob. Extinguish flames carefully using a lid, fire blanket or something similar.
- The cooking surface becomes very hot. Do not set any combustible objects on the hob. Do not store any objects on the hob.
- The appliance gets hot. Do not keep combustible objects or aerosol cans in drawers directly underneath the hob.
- The hob switches off automatically and can no longer be operated. It may switch on unintentionally at a later point. Switch off the circuit breaker in the fuse box. Contact the after-sales service.
- Do not use hob covers here. They can cause accidents, for example due to overheating, catching fire or materials shattering.

⚠ Warning – Risk of burns!

- The cooking positions and the adjacent areas, particularly the hob frame (if present), become extremely hot. Never touch the hot surfaces. Keep children away from the appliance.
- The hotplate heats up but the display does not work. Switch off the fuse in the fuse box. Inform technical after-sales service.
- Metal objects on the hob quickly become very hot. Never set metal objects, such as knives, forks, spoons, lids, or other objects that contain metal on the hob.
- After each use, always turn off the hob at the main switch. Do not wait until the hob turns off automatically after the pan is removed.

⚠ Warning – Risk of electric shock!

- Incorrect repairs are dangerous. Repairs may only be carried out and damaged power cables replaced by one of our trained after-sales technicians. If the appliance is defective, unplug the appliance from the mains or switch off the circuit breaker in the fuse box. Contact the after-sales service.
- Do not use any high-pressure cleaners or steam cleaners, which can result in an electric shock.
- A defective appliance may cause electric shock. Never switch on a defective appliance. Unplug the appliance from the mains or switch off the circuit breaker in the fuse box. Contact the after-sales service.
- Cracks or fractures in the glass ceramic may cause electric shocks. Switch off the circuit breaker in the fuse box. Contact the after-sales service.

⚠ Warning – Hazard due to magnetism!

The wireless cooking sensor is magnetic. The magnetic elements may damage electronic implants, e.g. pacemakers or insulin pumps. People fitted with electronic implants should therefore not carry the cooking sensor in their pockets and always keep it at least 10 cm away from their pacemaker or similar medical device.

⚠ Warning – Risk of fault!

A fan is located on the underside of this hob. If a drawer is located on the underside of the hob, do not store any small or sharp objects, paper or tea towels in it. These may be sucked in and damage the fan or impair the cooling.

There must be a clearance of at least 2 cm between the contents of the drawer and the fan entry point.

⚠ Warning – Risk of injury!

- The wireless cooking sensor is powered by a battery, which may become damaged if it is exposed to high temperatures. Remove the sensor from the cookware and store it away from any heat sources.
- The cooking sensor may be very hot when removing it from the saucepan. Wear oven gloves or use a tea towel to remove it.
- When cooking in a bain marie, the hob and cooking container could shatter due to overheating. The cooking container in the bain marie must not directly touch the bottom of the water-filled pot. Only use heat-resistant cookware.
- Saucepans may suddenly jump due to liquid between the pan base and the cooking position. Always keep the cooking position and saucepan bases dry.

Causes of damage

Caution!

- Rough pan bases may scratch the hob.
- Avoid leaving empty pots and pans on the cooking position. Doing so may cause damage.
- Do not place hot pans on the control panel, the indicator area, or the hob frame. Doing so may cause damage.
- Hard or pointed objects dropped on the hob may damage it.
- Aluminium foil and plastic containers will melt if placed on the cooking position while it is hot. The use of laminated sheeting is not recommended on the hob.

Overview

The table below lists the commonest kinds of damage:

Damage	Cause	Remedy
Stains	Food boiling over	Remove any food that has boiled over immediately with a glass scraper
	Unsuitable cleaning agents	Only use cleaning agents that are suitable for this type of hob
Scratches	Salt, sugar and sand	Do not use the hob as a work surface or storage space
	Rough pan bases can scratch the hob	Inspect the cookware
Discolouration	Unsuitable cleaning agents	Only use cleaning agents that are suitable for this type of hob
	Wear caused by cookware	Lift pots and pans when moving them.
Blistering	Sugar, food with a high sugar content	Remove any food that has boiled over immediately with a glass scraper

Environmental protection

In this section, you can find information about saving energy and disposing of the appliance.

Tips for saving energy

- Always use a matching lid with your cookware. Cooking without a lid consumes significantly more energy. Use a glass lid. This allows you to see into the pan without removing the lid.
- Use cookware with a flat base. Uneven bases increase the energy consumption.
- Always place items of cookware inside the usable area of the cooking surface.
- Use small pots and pans to cook small quantities. Using cookware that is big but barely filled requires a lot of energy.
- Cook with as little water as possible. This saves energy and preserves the vitamins and minerals in vegetables.
- Switch to a lower power level in good time. This prevents energy from being wasted.

Environmentally-friendly disposal

Dispose of packaging in an environmentally-friendly manner.



This appliance is labelled in accordance with European Directive 2012/19/EU concerning used electrical and electronic appliances (waste electrical and electronic equipment - WEEE). The guideline determines the framework for the return and recycling of used appliances as applicable throughout the EU.

The wireless cooking sensor is battery-powered. Dispose of spent batteries in an environmentally responsible manner.

Induction cooking

Advantages of induction cooking

Induction cooking is fundamentally different from traditional cooking methods, as heat builds up directly in the item of cookware. This offers numerous advantages:

- Saves time when boiling and frying.
- Energy savings.
- Easier to care for and clean. Spilled food does not burn on as quickly.
- Heat control and safety – the hob increases or decreases the heat supply as soon as the user changes the setting. If the cookware is removed, the induction cooking position immediately interrupts the heat supply without it having been switched off.

Cookware

Only use ferromagnetic cookware for induction cooking, such as:

- Cookware made from enamelled steel
- Cookware made from cast iron
- Special induction-compatible cookware made from stainless steel.

To find out whether your cookware is suitable for induction cooking, check whether a magnet is attracted to the base of the item or refer to the manufacturer's specifications.

Some induction cookware does not have a fully ferromagnetic base:

- If the base of the cookware is only partially ferromagnetic, only the area that is ferromagnetic will heat up. This may mean that heat will not be distributed evenly. The non-ferromagnetic area may not heat up to a sufficient temperature for cooking.

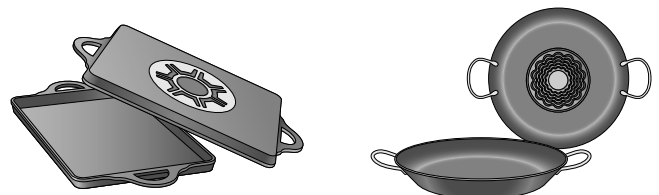

- The ferromagnetic area will also be reduced if the material from which the base of the cookware is made contains aluminium, for example. This may mean that the cookware will not become sufficiently hot or even that it will not be detected.

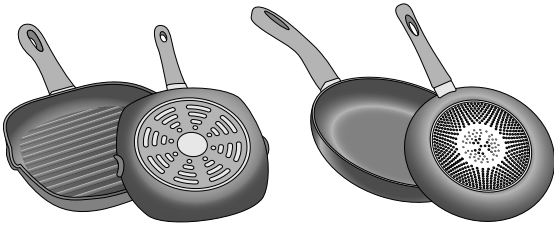

Unsuitable pans

Never use diffuser hobs or pans made from:

- common thin steel
- glass
- earthenware
- copper
- aluminium

Properties of the base of the cookware

The material(s) from which the base of the cookware is made can affect the cooking result. Cookware made of materials that distribute heat evenly, such as saucepans with a stainless steel sandwich base, save time and energy.

Cookware with a completely flat base works best. If the base of the cookware is uneven or embossed, this will reduce the heat supply.

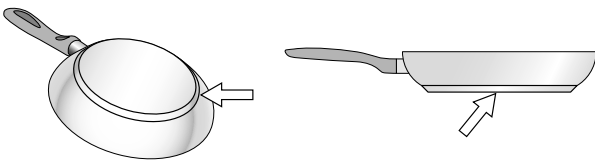

Cookware that has been removed or is of an unsuitable size

Always place items of cookware inside the usable area of the cooking surface. If the cookware is not positioned correctly, is made of an unsuitable material or is not the right size, the ⊖ symbol will appear next to the cooking position display. Move the cookware or try again with a different pot or pan.

If you lift the "active" cookware from the cooking surface for more than 30 seconds, the cooking position automatically switches off.

Empty cookware or cookware with a thin base

Do not heat empty items of cookware and do not use cookware that has a thin base. The hob is equipped with an internal safety system. However, an empty item of cookware can heat up so quickly that the automatic switch-off function has no time to react and an excessively high temperature is reached. This could melt the base of the cookware and damage the glass plate. If this happens, switch off the hob and do not touch the cookware. If this no longer works once it has cooled down, contact our technical after-sales service.

Pan detection

The hob uses the ferromagnetic diameter and material of the base of the cookware to automatically detect the position, size and shape of the cookware being used. Cookware with a base measuring 90 to 340 mm in diameter is suitable for use.

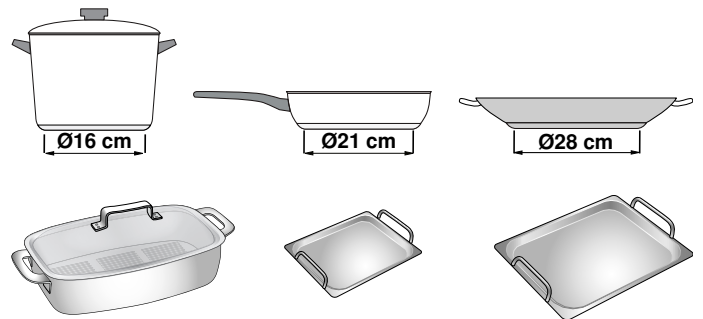

Note: The cooking position displays may show a size and shape that is different from the cookware actually being used. This is normal and does not affect the functioning of the hob. For more information, see the section entitled → "Frequently Asked Questions (FAQ)".

Getting to know your appliance

This section explains how to use the cooking surface, the control panel and the various different functions of the appliance.

Note: Depending on the appliance model, individual details and colours may differ.

Cooking surface

The entire cooking surface of the hob supplies induction heating. You can place items of cookware anywhere inside the usable area of the cooking surface. The position, size and shape of the cookware will be detected automatically.

Note: Up to 5 items of cookware can be heated at the same time on the cooking surface.

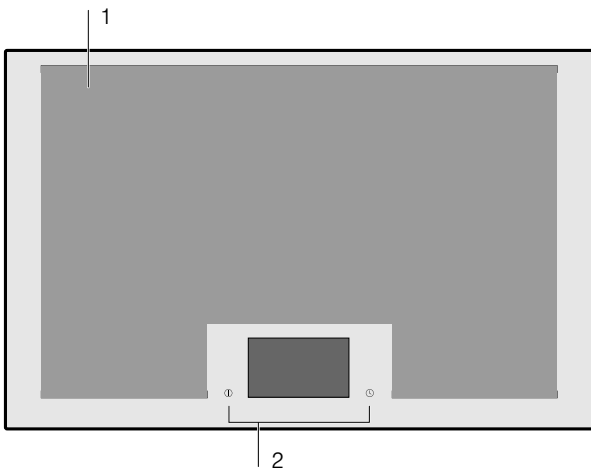

Hob

- 1 Usable cooking surface
- 2 Control panel

The control panel

The control panel has buttons and a touchscreen display.

Buttons

The buttons are touch-sensitive. To select a function, touch the relevant symbol. The available functions will appear in the display.

Notes

- Always keep the control panel clean and dry. Moisture can prevent it from working properly.
- Never place hot cookware on the touchscreen display. The electronics could overheat.

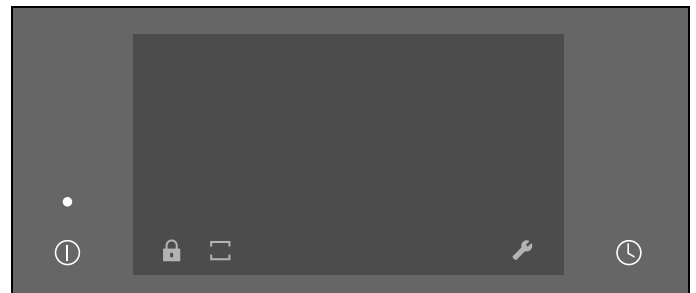

Buttons

ⓘ	Main switch
🕒	Time menu
⌚	Short-term timer
⌛	Stopwatch
🔒	Childproof lock
⏸	Pause function
☐	Hob mode
⬆️⬆️	Dynamic cooking
⬆️	Professional cooking
☐	Classic cooking
✳️	Ventilation control
🔧	Basic settings
📍	Cooking position
1.0 - 9.0	Heat settings
➤➤	Saucepan booster function
➤	Frying pan booster function
🔥	Keep-warm function
🕒	Cooking timer
🍲	Cookware mode
☐*	Dynamic control for an item of cookware
☐	Classic cooking for an item of cookware
🔥	Cooking sensor
☐	Teppanyaki

Touchscreen display

The touchscreen display gives you an overview of the cookware on the cooking surface and the buttons for activating the various functions.

When an item of cookware is set down on the cooking surface, the cooking position display for this cookware is shown on the display.

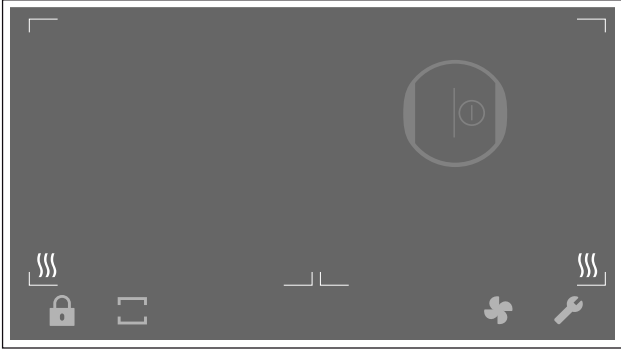

Overview of the menus

The intuitive menu structure helps you to find your way around the control panel of your hob. You can find out more about the most important menus in this section.





Main screen

The main display provides an overview of the indicators for the cookware on the cooking surface. It displays the cooking mode, power levels, and the timer functions that are set for the cooking zones that are switched on.

Function bar

The function bar provides access to a number of functions and other menus.

The following options are shown in the function bar:

-  Childproof lock
-  Pause function
-  Cooking mode
-  Ventilation control
-  Basic settings

Info menu

The info menu provides you with information about the appliance or the functions that are currently active.

To access the info menu, touch the **i** symbol on the function bar. The sensor will show when the function is available.

Notifications and alerts

Notifications let the user know that the appliance's status has changed or tell them when they need to confirm something.

To return to the main screen, touch the  symbol.

Note: The top line of the display lights up orange.



The information makes you aware that a measure is required.

Follow the instructions in the display and touch the  symbol to return to the main screen.

Note: The top line of the display lights up blue.

Cooking mode





The hob has various functions for the entire cooking surface.

Cooking mode	Function
 Professional cooking	Allows the heat setting to be selected based on the position of the cookware on the cooking surface, from right to left.
 Classic cooking	Allows you to select the heat setting for the cooking position.
 Dynamic cooking	Allows the heat setting to be selected based on the position of the cookware on the cooking surface, from front to back.

To access the hob mode menu, touch the  button on the function bar.

Cookware mode

The hob has various functions for the cooking position.

Cookware mode	Function
 Dynamic cooking for an item of cookware	Allows a particular heat setting to be selected based on the position of the cookware by moving it from front to back on the cooking surface.
 Classic cooking for an item of cookware	Allows the heat setting for each item of cookware to be selected on the control panel.
 Cooking sensor	You can use the cooking sensor that is attached to the outside of the pan to automatically keep the temperature at a set level. Cooking sensor mode is suitable for food that requires large quantities of water, oil or fat for boiling or deep-fat frying in the pan.
 Teppanyaki	This enables the teppanyaki surface to be divided into two sections. This means you can fry food on one section and keep food warm on the other section, or use the entire area to fry food at the same heat setting.

To access the cookware mode menu, tap the cooking position display and then touch the  button.

Cooking position display

When you place an item of cookware on the cooking surface, the indicator for the relevant cooking position will light up on the touchscreen display.

Cooking position detected

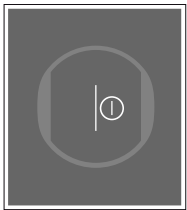

The cookware was detected on the cooking position. The cooking position display lights up. Touch the  symbol to select the cooking position.

Cooking position selected



The indicated cooking position has been selected. You can now set the power level.

Cooking position switched on



The indicated cooking position has been switched on. The selected power level lights up in the display.

There is no cookware on the cooking position



The cookware has been removed from the cooking position. The selected power level is dimmed.

Other indicators and symbols





The settings for the selected hotplate cannot be configured.

For more information, touch the display.

Possible causes:

- Up to five items of cookware evenly distributed over the cooking surface can be heated at the same time.
- The cookware is not suitable for use on an induction hob.
- The appliance has exceeded its maximum power consumption.

Residual heat indicator

The hob has several residual heat indicators  to warn you that one or more cooking positions is/are still hot. One, two or all three bars of the indicator  will light up depending on how strong the residual heat is. Do not touch the cooking surface while the indicators are still lit or immediately after they have switched off.

The residual heat indicators will remain lit for as long as the cooking surface is still hot, even if you switch off the hob.

Operating the appliance

This chapter explains how to set a cooking position. The table shows heat settings and cooking times for various meals.

First-time use

When you switch on the appliance for the first time, the menu for selecting the initial settings appears on the display. Select the settings you require.

Once you have confirmed these settings, the main screen will appear.

Note: You can change the settings at any time. For information on how to select these settings, see the section entitled → "Basic settings".

Switching the hob on and off

The main switch is used to switch the hob on and off.

To switch the hob on: Touch the ① symbol. The indicator above the main switch lights up. After a short switch-on time, the hob will be ready for operation.

To switch the hob off: Touch the ① symbol. The display switches off. All the cooking positions are switched off.

The residual heat indicator will remain lit until the cooking positions have cooled down sufficiently.

Notes

- The hob will automatically switch off if the cooking positions have been switched off for more than 30 seconds.
- The settings are stored for 10 seconds after the hob has been switched off. If you switch the hob back on during this time, the option to confirm the previous settings will appear on the main screen. For information on this setting, see the section entitled → "Basic settings".

Configuring cooking position settings

The required heat setting is selected in the settings area.

Heat setting 1.0	= lowest setting
Heat setting 9.0	= highest setting

Each heat setting has an intermediate setting ending in .5.

Notes

- To protect the fragile parts of your appliance from overheating and electrical overloading, the hob may temporarily reduce the power.
- In order to prevent the appliance from producing excess noise, the hob may temporarily reduce the power.

Selecting a hotplate and heat setting

The hob must be switched on.

- 1 Place the cookware on the cooking surface.
- 2 Touch the ① symbol for the cooking position on the touchscreen display. The settings area will light up on the cooking position display.

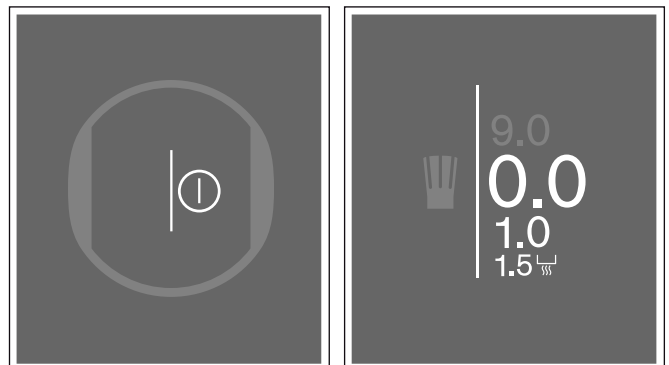

- 3 Within the next 4 seconds, scroll up with your finger and select the heat setting you require. To select heat setting 9.0, tap 9.0 directly.



The heat setting is set.

Changing the heat setting

Select the cooking position and then set the required heat setting in the control panel.

Switching off a cooking position

Touch and hold the cooking position display until heat setting **0.0** is displayed in the settings area. The cooking position will switch off.

Note: If you place an item of cookware on the cooking surface before switching on the hob, this will be detected when you touch the main switch and the cooking position display will appear on the touchscreen display.

Chef's recommendations

Recommendations

- When heating up puree, cream soups and thick sauces, stir occasionally.
- Set heat setting 8 to 9 for preheating.
- When cooking with the lid on, turn the heat setting down as soon as steam escapes between the lid and the cookware. Steam does not need to escape for a good cooking result.
- After cooking, keep the lid on the cookware until you serve the food.
- To cook with the pressure cooker, observe the manufacturer's instructions.
- Do not cook food for too long, otherwise the nutrients will be lost. The kitchen clock can be used to set the optimum cooking time.
- For a more healthy cooking result, smoking oil should be avoided.
- To brown food, fry small portions in succession.
- Cookware may reach high temperatures while the food is cooking. We recommend that you use oven gloves.
- You can find recommendations for energy-efficient cooking in section → "*Environmental protection*"

Recommended dishes

The table shows which heat setting is suitable for each type of food. The cooking time may vary depending on the type, weight, thickness and quality of the food.

	Ongoing cooking setting	Time (min)
Melting		
Chocolate, coating	1.0 - 1.5	-
Butter, honey, gelatine	1.0 - 2.0	-
Heating or keeping warm		
Stew, e.g. lentil stew	1.5 - 2.0	-
Milk ¹	1.5 - 2.5	-
Heating sausages in water ¹	3.0 - 4.0	-
Defrosting and heating		
Spinach, frozen	3.0 - 4.0	15 - 25
Goulash, frozen	3.0 - 4.0	35 - 55
Poaching, simmering		
Potato dumplings ¹	4.5 - 5.5	20 - 30
Fish ¹	4.0 - 5.0	10 - 15
White sauces, e.g. Béchamel sauce	1.0 - 2.0	3 - 6
Whisked sauces, e.g. Béarnaise sauce, Hollandaise sauce	3.0 - 4.0	8 - 12

¹ Without a lid

² Turn several times

³ Preheat at setting 8.0-8.5

	Ongoing cooking setting	Time (min)
Boiling, steaming, braising		
Rice (with double the volume of water)	2.5 - 3.5	15 - 30
Rice pudding ³	2.0 - 3.0	30 - 40
Unpeeled boiled potatoes	4.5 - 5.5	25 - 35
Boiled potatoes	4.5 - 5.5	15 - 30
Pasta ¹	6.0 - 7.0	6 - 10
Stew	3.5 - 4.5	120 - 180
Soups	3.5 - 4.5	15 - 60
Vegetables	2.5 - 3.5	10 - 20
Vegetables, frozen	3.5 - 4.5	7 - 20
Stew in a pressure cooker	4.5 - 5.5	-
Braising		
Rolled roasting joint	4.0 - 5.0	50 - 65
Pot roast	4.0 - 5.0	60 - 100
Goulash ³	3.0 - 4.0	50 - 60
Braising/frying with a small amount of oil ¹		
Escalope, plain or breaded	6.0 - 7.0	6 - 10
Escalope, frozen	6.0 - 7.0	6 - 12
Chops, plain or breaded ²	6.0 - 7.0	6 - 12
Steak (3 cm thick)	7.0 - 8.0	6 - 12
Poultry breast (2 cm thick) ²	5.0 - 6.0	10 - 20
Poultry breast, frozen ²	5.0 - 6.0	10 - 30
Rissoles (3 cm thick) ²	4.5 - 5.5	20 - 30
Hamburgers (2 cm thick) ²	6.0 - 7.0	10 - 20
Fish and fish fillet, plain	5.0 - 6.0	8 - 20
Fish and fish fillet, breaded	6.0 - 7.0	8 - 20
Fish, breaded and frozen, e.g. fish fingers	6.0 - 7.0	8 - 15
Prawns and scampi	7.0 - 8.0	4 - 10
Sautéing fresh vegetables and mushrooms	7.0 - 8.0	10 - 20
Asian stir fries (vegetables and pieces of meat)	7.0 - 8.0	15 - 20
Stir fries, frozen	6.5 - 7.5	6 - 10
Pancakes (cooked one after the other)	6.5 - 7.5	-
Omelette (cooked one after the other)	3.5 - 4.5	3 - 10
Fried eggs	5.0 - 6.0	3 - 6
Deep-fat frying ¹ (150-200 g per batch in 1-2 l oil, deep-fat fried in batches)		
Frozen products, e.g. chips, chicken nuggets	8.0 - 9.0	-
Croquettes, frozen	7.0 - 8.0	-
Meat, e.g. chicken portions	6.0 - 7.0	-
Fish, breaded or beer-battered	6.0 - 7.0	-
Vegetables, mushrooms, breaded, beer-battered or tempura	6.0 - 7.0	-
Small baked items, e.g. doughnuts, beer-battered fruit	5.5 - 6.5	-

¹ Without a lid

² Turn several times

³ Preheat at setting 8.0-8.5

Dynamic cooking

Use this special function in particular for cooking processes that require the power levels to be changed frequently. This allows you to change the power level quickly and easily during cooking simply by moving the cookware forwards or backwards.

Activating this function turns the entire cooking surface into a single cooking area with three different power levels. The appliance selects which of the default power levels to use depending on the position of the cookware. The power level that is assigned to each item of cookware appears in the relevant cooking position display.

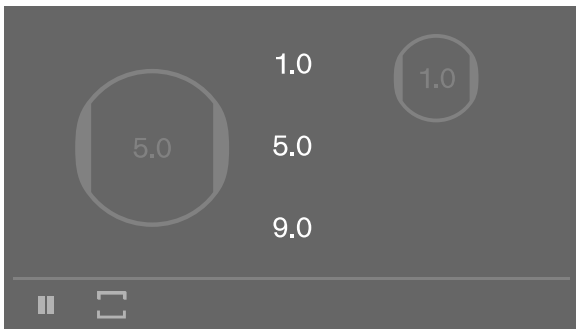

Default power levels:

Front section = power level **9.0**

Middle section = power level **5.0**



Rear section = power level **1.0**

You can change the default power levels. To change the power levels, see the section entitled → *"Basic settings"*

Notes

- The booster function for saucepans and frying pans and the keep-warm function are not available while dynamic cooking mode is active.
- While dynamic cooking mode is active, the different cookware modes will not be available and you will not be able to set the cooking time.
- If cookware is moved over the cooking surface, the hob will automatically start searching and the heat setting of the area on which the cookware has been detected will be set.
- For more information on the size and positioning of the cookware, see the section entitled → *"Induction cooking"*.

Activation

- 1 Touch the  symbol.
- 2 Touch the  symbol followed by the  symbol to confirm your choice. The three default power levels are displayed on the main screen.

This function has now been activated.

Set down the cookware

If active cookware is on the cooking position before you activate the function, the cooking position display appears without a power level. To confirm the power level that is assigned, tap on the cooking position display and then touch the sensor field .

If new cookware is placed on the cooking position, tap the cooking position display and then touch the sensor field .

Note: If the size of the cookware is not suitable for this function, the  symbol will light up on the cooking position.

Touch the  symbol for information.



To return to the main screen, touch the .

Changing the heat setting

You can change the power levels while you are cooking. To choose a different hob operating mode in the programming area, touch the area you want to change the power level of.

Note: If the function is deactivated, the power levels will return to the default values

Deactivating

- 1 Touch the  symbol.
- 2 Select a different hob operating mode and then touch the  symbol to confirm your selection. The heat power levels that are assigned to the relevant cookware are retained.

This function has now been deactivated.

Professional cooking

Use this special function in particular for cooking processes that require the power levels to be changed frequently. This allows you to change the power level quickly and easily during cooking simply by moving the cookware to the left or right.

Activating this function turns the entire cooking surface into a single cooking area with three different power levels. The appliance selects which of the default power levels to use depending on the position of the cookware. The power level that is assigned to each item of cookware appears in the relevant cooking position display.

Default power levels:

Left-hand section = power level **1.5**

Middle section = power level **9.0**



Right-hand section = power level **5.0**

You can change the default power levels. To change the power levels, see the section entitled → *"Basic settings"*

Notes

- For more information on the size and positioning of the cookware, see the section entitled → *"Induction cooking"*.
- While this function is active, cookware mode and the booster function for saucepans and frying pans will not be available and you will not be able to set the cooking time.

Activation

- 1 Touch the  symbol.
- 2 Touch the  symbol followed by the  symbol to confirm your choice.
The default power levels is displayed on the main screen.

This function has now been activated.

Set down the cookware

If active cookware is on the cooking position before you activate the function, the cooking position display appears without a power level. To confirm the power level that is assigned, tap on the cooking position display and then touch the sensor field .

If new cookware is placed on the cooking position, tap the cooking position display and then touch the sensor field .

Note: If the size of the cookware is not suitable for this function, the  symbol will light up on the cooking position.

Touch the  symbol for information.

To return to the main screen, touch the  symbol.

Combining sections

The sections with the default power levels can be combined to form one large surface with the same power level.

To do this, touch one of the vertical edges of the middle section and swipe left or right with your finger to the end of the adjacent section.

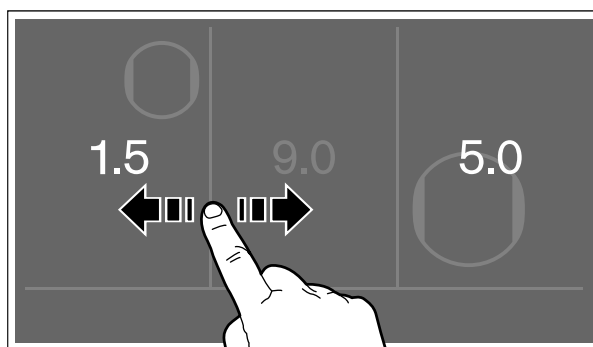

The power level of the combined area is the same as the power level of the section being expanded.

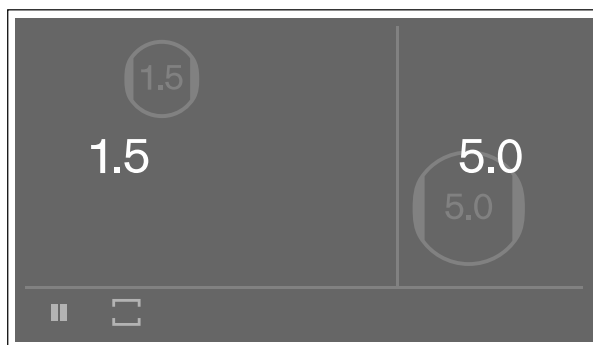

To separate the combined area again, touch one of the vertical edges of the area and swipe left or right with your finger until the hidden section reappears.

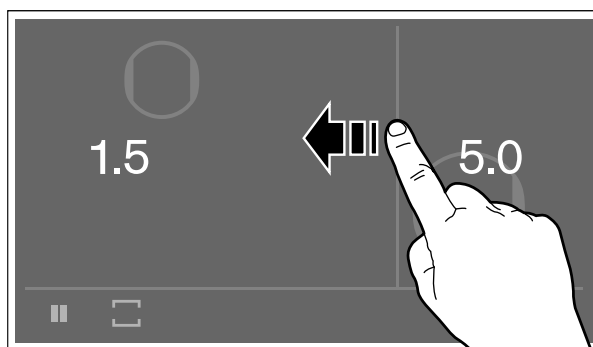



Changing the heat setting

You can change the power levels while you are cooking. To choose a different power level in the programming area, touch the area you want to change the power level of.

Note: If the function is deactivated, the power levels will return to the default values

Deactivating

- 1 Touch the  symbol.
- 2 Select a different hob operating mode and then touch the  symbol to confirm your selection. The heat power levels that are assigned to the relevant cookware are retained.

This function has now been deactivated.

Time-setting options

The hob has three timer functions:



- Setting the cooking time
- Stopwatch
- Timer

Cooking timer

The cooking position will switch off automatically once the time that is set has elapsed.

You can set a cooking time of up to 12 hours 59 minutes.

Setting procedure:

- 1 Select the cooking position and the required heat setting.
- 2 Touch the selected power level. The  symbol will light up in the cooking position display.
- 3 Touch the  symbol. **00|00** ^h_{min} will light up on the cooking position display.

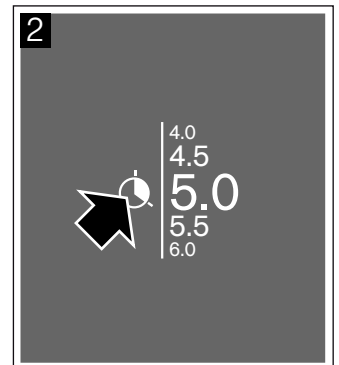
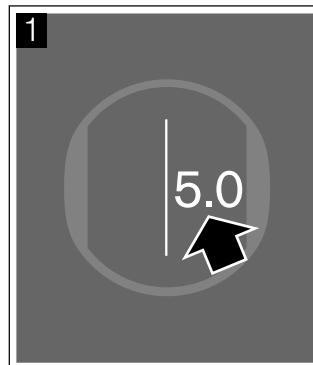

- 4 Then select the cooking time you require in hours and minutes.

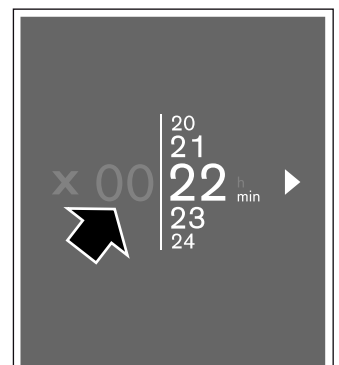
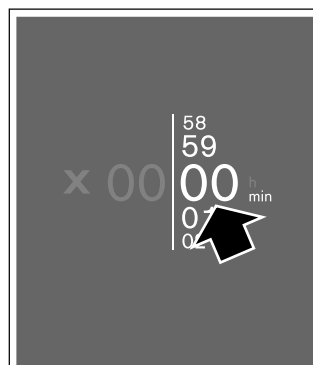

- 5 Touch the ► symbol to confirm the selected time. The time you have set will appear in the cooking position display.

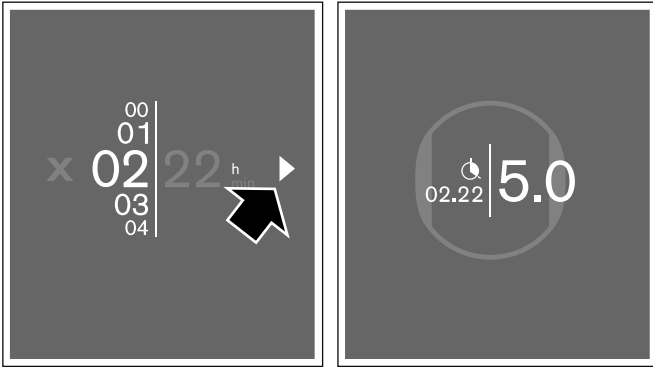

The cooking time begins to elapse.

Cooking sensor mode

If a cooking time has been set for a cooking position and cooking sensor mode is active, the time will not start to count down until the selected temperature has been reached.

Changing or deleting the time

Select the ⌚ symbol.

Change the time that is currently set and then touch the ► symbol to confirm the setting you have chosen.

To delete the time, touch the ■ symbol.

When the time has elapsed

The cooking position will switch off. An audible signal will sound. The set cooking time will revert to **00.00** and the heat setting to **0.0**.

Tap the time indicator. The indicators will go out and the signal tone will stop.

Stopwatch function

The stopwatch function displays the time that has elapsed since activation.

This functions independently from the cooking positions and from other settings. This function does not automatically switch off a cooking position.

Activating

Touch the ⌚ button and select the ⌚ symbol. Then touch the ► symbol to confirm your choice. **00.00** and the ⌚ symbol will light up in the function bar.



The stopwatch has now been activated. The time will begin to elapse.

Stopping the stopwatch

Touch the ⌚ symbol followed by the || symbol. The stopwatch will stop and reappear on the main screen.

To start the stopwatch again, press the ⌚ symbol followed by the ► symbol.

Deactivating

Touch the ⌚ symbol followed by the ■ symbol. The stopwatch will stop. The time will reset to **00.00** and reappear on the main screen.

This function has now been deactivated.

Note: To clear the menu and return to the main screen, touch the ✕ symbol.

Short-term timer

You can set a time of up to 9 hours, 59 minutes and 59 seconds on the short-term timer.

You can activate it whether the hob is switched on or off.

It works independently of the cooking positions and other settings. This function does not automatically switch off a cooking position.

Setting procedure:

- 1 Touch the ⌚ button.
- 2 Touch the ⌚ symbol and confirm your choice by touching ✓. 00 | 00.00^{h min sec} will light up on the display.
- 3 Within the next 10 seconds, scroll up or down with your finger and set the time in minutes, hours and seconds.

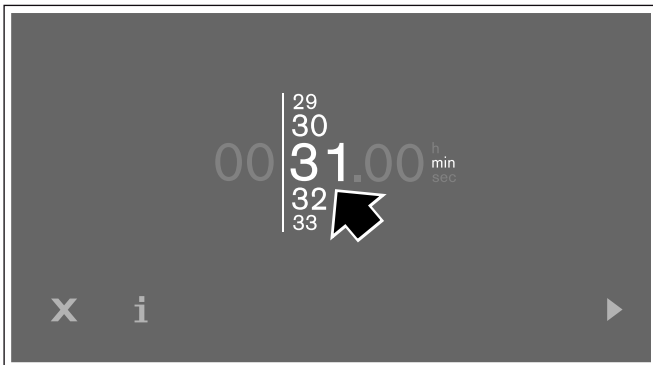

- 4 Touch the ▶ symbol to confirm the selected setting. The ⌚ symbol and the selected time will light up in the function bar.

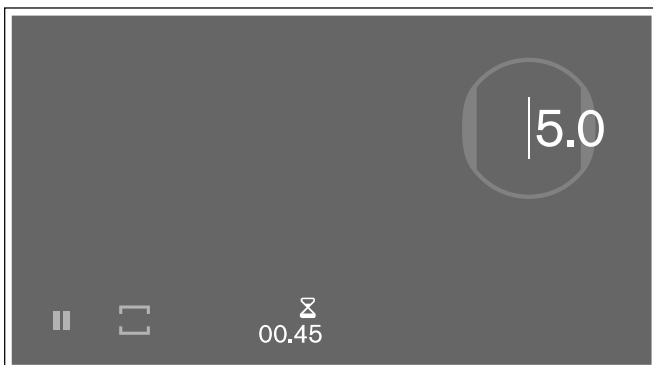

The selected time will start to count down.

Changing or deleting the time

Touch the ⌚ symbol.

Change the time that is currently set and touch the ▶ symbol to confirm the setting you have chosen.

To delete the time, touch the ■ symbol.

Stopping the short-term timer

Touch the ⌚ symbol followed by the || symbol. The timer will stop and reappear on the main screen.

To start the timer again, press the ⌚ symbol followed by the ▶ symbol.

When the time has elapsed

A signal tone will sound. 00.00 will flash on the timer display.

Touch the ⌚ symbol. The indicators will go out and the signal tone will stop.

Touching and holding the ⌚ symbol for a few seconds will activate the stopwatch. The time that has elapsed is shown on the display in front of the + symbol.

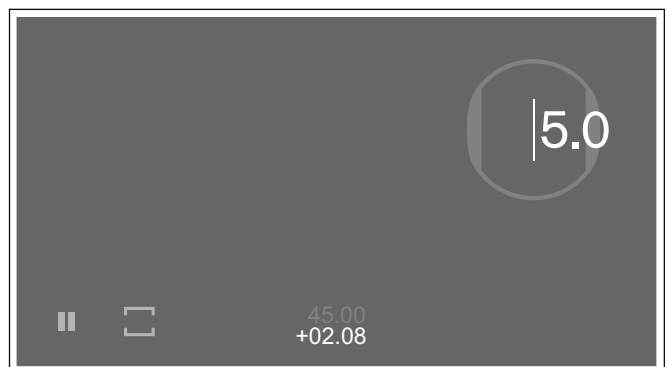

To set a new time on the short-term timer, touch the time indicator.

If you touch and hold the time indicator for a few seconds, the time information on the display will go out.

Booster function for pots

The booster function allows large volumes of water to be heated up more quickly than with power level 9.0.

This function is available if the >> symbol is displayed in the settings area for the cookware.

The saucepan booster function is available for a maximum of one pan per side of the cooking surface.

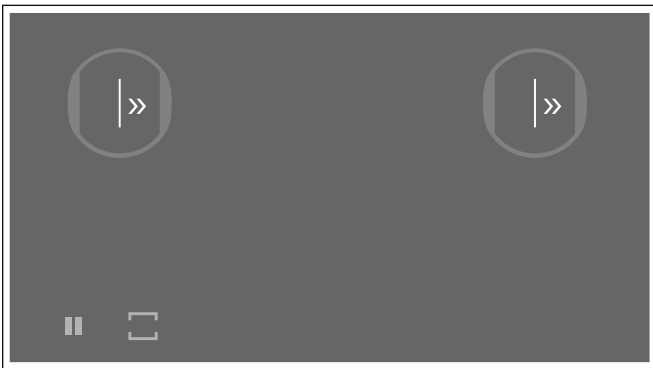

If the saucepan booster function is active and you select a second cooking position on the same side of the cooking surface, the saucepan booster function will be deactivated. The cooking position is automatically set to heat setting 9.0.

If the booster function for saucepans in the centre of the cooking surface is active, settings can be implemented for other items of cookware on the left- and right-hand side of the hob.

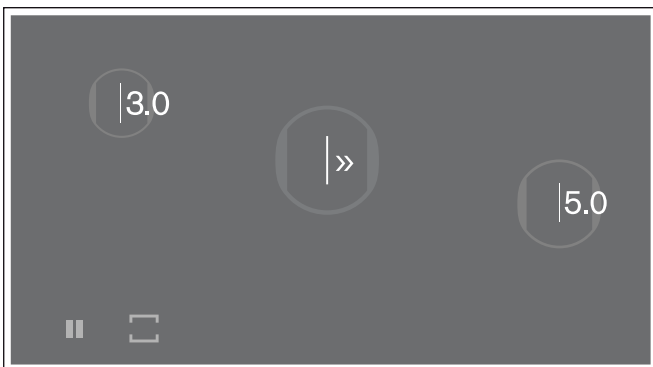

Activating

Select the cooking position and scroll up with your finger until the >> symbol appears.

The function has now been activated.

Deactivating

Touch the cooking position display and select any power level in the settings area.

This function has now been deactivated.

Note: Under certain circumstances, the function will switch off automatically to protect the electronic components inside the hob.

The cooking position will switch back to power level 9.0 automatically.

Booster function for pans

The frying pan booster function allows cookware to be heated up more quickly than with power level 9.0.

After deactivating the function, select the appropriate power level for your food.

This function is available if the  symbol is displayed in the settings area for the cookware.

The frying pan booster function is available for a maximum of one item of cookware per cooking surface.

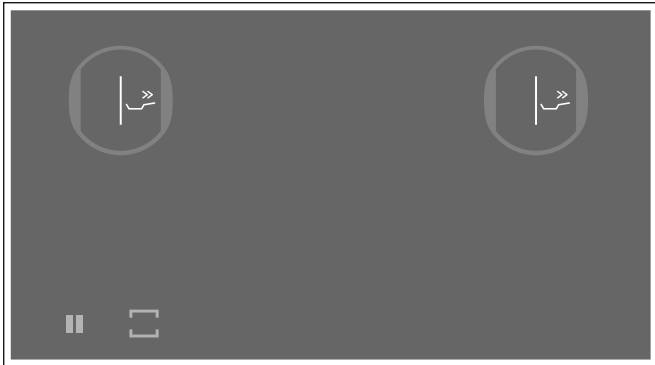

If the frying pan booster function is active and settings for a different cooking position on the same side of the cooking surface are selected, the pan booster function will be deactivated and heat setting 9.0 set automatically.

If the booster function for frying pans in the centre of the cooking surface is active, settings can be implemented for other items of cookware on the left- and right-hand side of the hob.

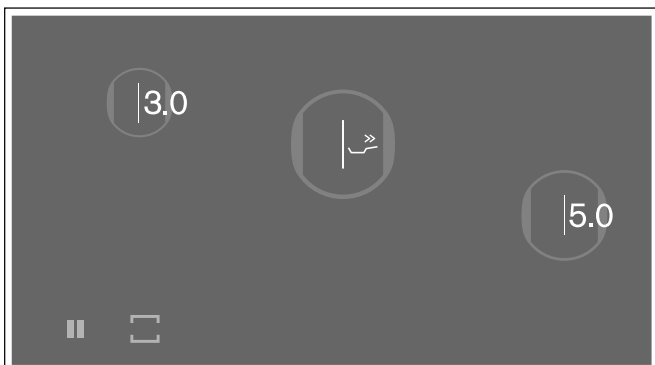

Recommendations for use

- Always use cold cookware.
- Use cookware with a fully flat base. Do not use cookware with a thin base.
- Never leave empty cookware, oil, butter or lard unattended when it is being heated.
- Do not place a lid on the cookware.
- For information on the type, size and positioning of the cookware, see the section entitled → "Induction cooking".

Activating

Touch the cooking position display and select the  symbol in the settings area.

The function has now been activated.

Deactivating

Touch the cooking position display and select any power level in the settings area.

This function has now been deactivated.

Note: After 30 seconds, this function automatically switches itself off. The cooking position automatically switches back to power level 9.0.

Keep warm function

This function is suitable for melting chocolate or butter and for keeping food warm.

Activating

Select the relevant cooking position and then set the power level to **1.5** in the settings area.

Deactivating

Touch the cooking position display and select any power level in the settings area.

This function has now been deactivated.

Transfer function

This function lets you transfer the selected power level or temperature setting and the cooking time from one cooking position to another.

If you remove an item of cookware from the cooking surface or move it, the cooking position it was previously on stops heating. The settings for the cooking position will be retained for 30 seconds.

When you place the cookware back in this position, the same settings will be used.

Activation

- 1 Place an item of cookware on the cooking surface.

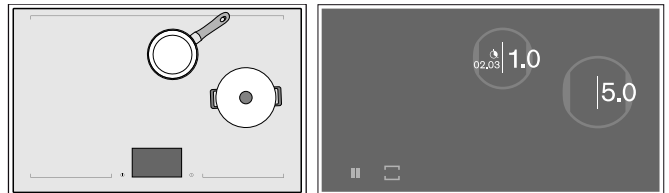

The  symbol will appear on the new cooking position.

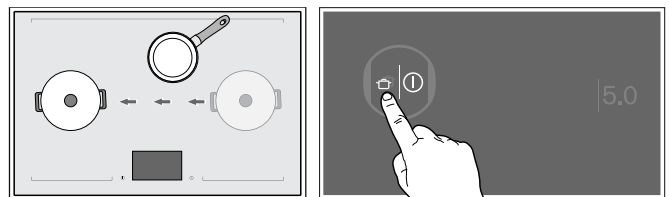

- 2 Touch the  symbol on the new cooking position to confirm transfer of the settings. The power level will light up.

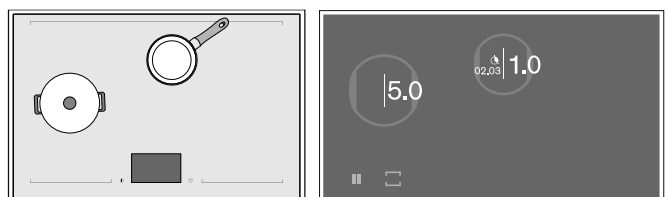

The settings have been transferred to the new cooking position.

Wireless temperature sensor

You will need to connect the wireless temperature sensor to the hob before using cooking sensor mode for the first time.

Preparing and maintaining the wireless temperature sensor

This section provides information on:

- Attaching the silicone patch
- Attaching the wireless cooking sensor
- Cleaning
- Replacing the battery

The silicone patch and temperature sensor can be purchased from specialist retailers or through our technical after-sales service or our official website. To do this, quote the relevant reference number:

00577921	Set of 5 silicone patches
CA060300	Temperature sensor and set of 5 silicone patches

Adhering the silicone patch

The silicone patch secures the cooking sensor to the cookware.

When using a saucepan with cooking sensor mode for the first time, the silicone patch must be attached directly to this saucepan. Proceed as follows:

- 1 That the adhesive area on the pan is free from grease. Clean the pan, dry it thoroughly and wipe the adhesive area with a spirit.
- 2 Remove the protective film from the silicone patch. Adhere the silicone patch to the outside of the pan in the correct place using the enclosed template as a guide.

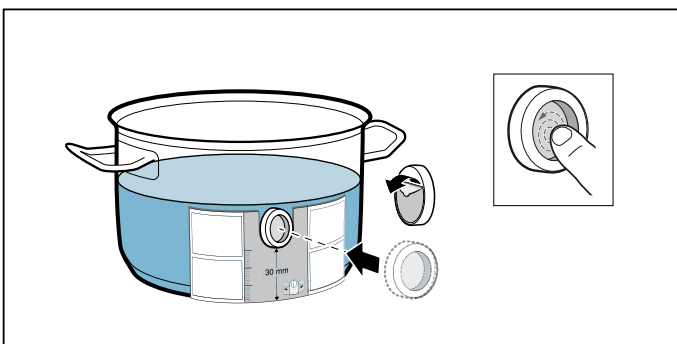

- 3 Press down all over the surface of the silicone patch, including in the centre.

The adhesive requires one hour to fully harden. Do not use or clean the pan during this time.

Notes

- Do not leave the pan with the silicone patch to soak soapy water for long periods of time.
- If the silicone patch comes off, attach a new one.

Fitting the wireless temperature sensor

Attach the temperature sensor to the silicone patch and align it correctly.

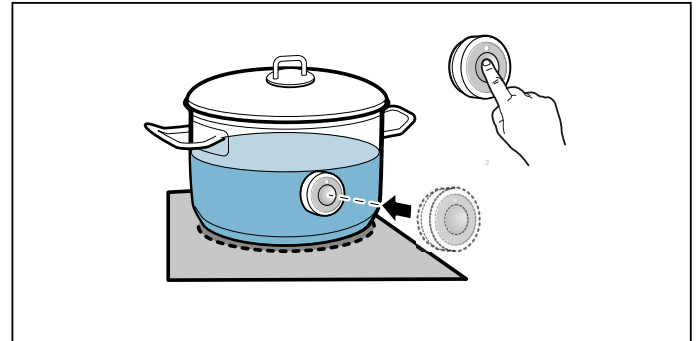







Notes

- Ensure that the silicone patch is completely dry before attaching the cooking sensor.
- Fill the pot so that the contents reach high enough to cover the cooking sensor's silicone patch.
- To prevent overheating, do not attach the cooking sensor to other hot cookware.
- Remove the cooking sensor from the pot after cooking. Store it in a clean, safe place away from sources of heat.
- You can use up to three cooking sensors at the same time.

Connecting the wireless temperature sensor to the control panel

To connect the wireless temperature sensor to the control panel, follow the instructions below:

- 1 Touch the  on the main screen.
- 2 Select the *Cooking sensor pairing* option and then touch the  symbol to confirm your choice.
- 3 Briefly touch the  symbol on the wireless cooking sensor within the next 30 seconds.
After a few seconds, the result of the connection between the cooking sensor and the control panel will appear on the display.
Then touch the  symbol to confirm.
- 4 To connect another cooking sensor, touch the  symbol. To return to the basic settings, touch the  symbol.

The Cooking sensor mode is available once the cooking sensor has been connected to the control panel correctly.

Notes

- If there is a fault with the cooking sensor, the connection may not be established correctly for the following reasons:
 - Bluetooth communication error.
 - The symbol on the cooking sensor was not pressed within 30 seconds.
 - The battery in the cooking sensor is flat.
 Reset the cooking sensor and repeat the connection procedure.
- If there are problems with the connection due to a transmission error, repeat the connection procedure.
If the display continues to indicate a connection error, contact our technical after-sales service.

Resetting the wireless temperature sensor

- 1 Touch and hold the  symbol on the cooking sensor for 8-10 seconds.
While you are doing this, the cooking sensor's LED indicator will light up three times. When the LED lights up for the third time, it will start to reset the cooking sensor. Take your finger off the symbol when this happens.
When the LED switches off, this means that the wireless cooking sensor has been reset.
- 2 Repeat the connection procedure.

Cleaning

Do not clean the wireless temperature sensor in the dishwasher.

Temperature sensor

Clean the temperature sensor with a damp cloth. Never clean it in the dishwasher. Do not immerse it in water or clean it under running water.

Remove the temperature sensor from the saucepan after cooking. Store it in a clean, safe place (such as in its packaging) away from sources of heat.

Silicone patch

Clean and dry before attaching to the temperature sensor. Dishwasher safe.

Note: Cookware with the silicone patch must not be left to soak for long periods in soapy water.

Temperature sensor window

The sensor window must always be clean and dry. Proceed as follows:

- Remove dirt and oil splatters regularly.
- Use a soft cloth or cotton buds and window cleaner for cleaning.

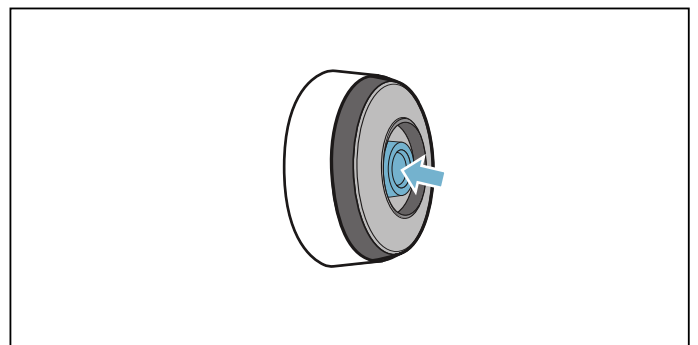

Notes

- Do not use abrasive cleaning agents such as scouring pads, scrubbing brushes or cream cleaners.
- Do not touch the sensor window with your fingers. This may make it dirty or scratch it.

Replacing the battery

If the temperature sensor does not light up when the symbol is pressed, the battery is flat.

Changing the battery:

- 1 Remove the silicone cover from the lower section of the temperature sensor housing and remove both screws using a screwdriver.

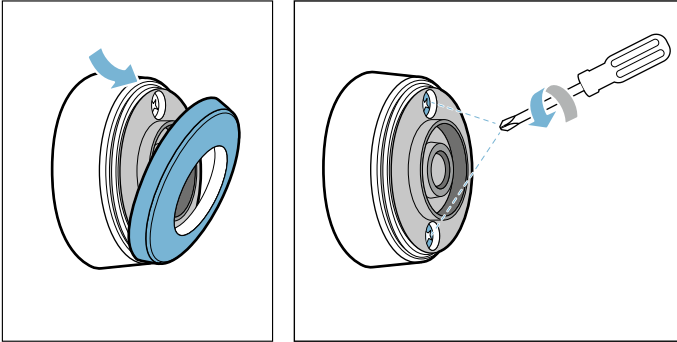

- 2 Open the closure of the temperature sensor. Remove the battery from the lower section of the housing and insert a new battery (pay attention to the correct orientation of the battery poles).

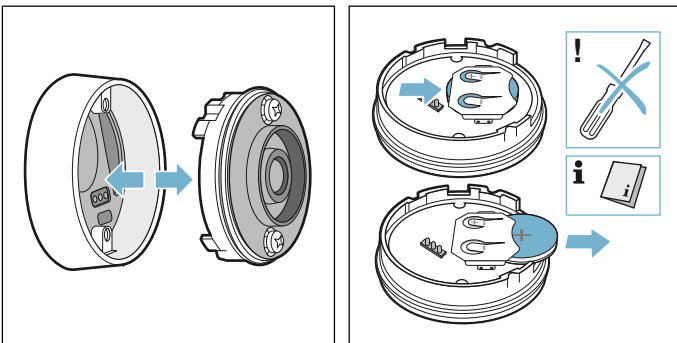

Caution!

Do not use any metal objects to remove the battery.
Do not touch the battery connection points.

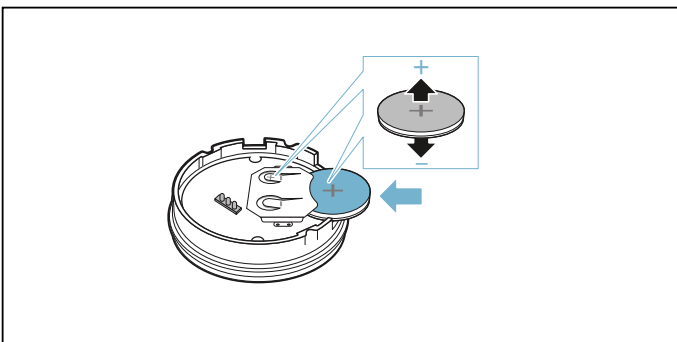

- 3 Close the closure of the temperature sensor (the notches for the screws on the closure must align with the notches on the lower section of the housing). Tighten the screws with a screwdriver.

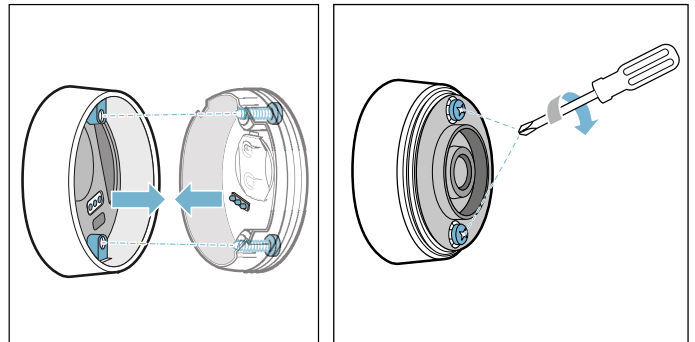

- 4 Reattach the silicone cover to the lower section of the temperature sensor housing.

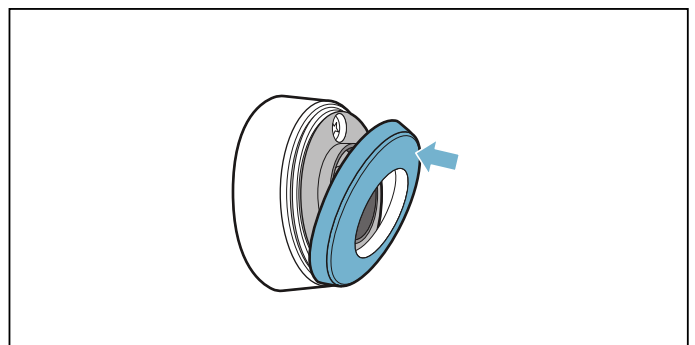

Note: Use only high-quality batteries of the type CR2032 in order to guarantee a long service life.

Declaration of Conformity

Gaggenau Hausgeräte GmbH hereby declares that the appliance with wireless temperature sensor function meets the basic requirements and other relevant provisions of the Directive 2014/53/EU.

A detailed RED Declaration of Conformity can be found online at www.gaggenau.com on the product page for appliance in the additional documents.

The logos and the Bluetooth® brand are registered trademarks and property of Bluetooth SIG, Inc. These trademarks are used by Gaggenau Hausgeräte GmbH under licence. All other trademarks and brand names are owned by the respective companies.

Cooking sensor mode

The cooking sensor processes make cooking easy and guarantee exceptional results.

The wireless cooking sensor measures the temperature of the cookware continuously. This allows cooking to be precisely regulated and the temperature to be maintained at the required level at all times in order to prevent excessively vigorous boiling and to achieve perfect cooking results.

You can add your food once the selected temperature has been reached. The temperature is automatically kept constant without you having to change the heat setting.

Cooking sensor mode is available anywhere on the cooking surface if you have a wireless cooking sensor.

The wireless cooking sensor forwards the temperature of the cookware to the control panel.

The hob has a wireless cooking sensor. If required, this can be purchased at a later point from specialist retailers, or through our technical after-sales service or our online shop. You can use up to three cooking sensors at the same time.



Note: You can order it by specifying the reference number CA060300.

For more information about the cooking sensor, see the section entitled → *"Wireless temperature sensor"*

Cooking processes with the cooking sensor

Cooking sensor mode is used to select the best cooking method for each kind of food.

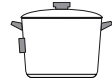
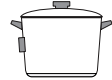
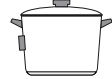
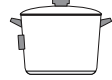
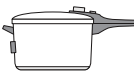
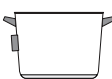
The table shows the different cooking processes that are available:

Cooking processes	Temperature	Cookware	Suitable for
Keeping warm, heating	70 °C		E.g. punch, goulash
Poaching in milk	85 °C		E.g. panna cotta, rice pudding
Poaching in water	90 °C		E.g. rice, quinoa
Boiling	100 °C		E.g. pasta, gnocchi, vegetables
Cooking in a pressure cooker	115 °C		E.g. home-made broths, pulses
Deep-fat frying at a low temperature *	160 °C		E.g. doughnuts, fritters
Deep-fat frying at a medium temperature *	170 °C		E.g. breaded fish, meatballs
Deep-fat frying at a high temperature *	180 °C		E.g. chips, frozen

*Heat the oil with the lid on and deep-fat fry with the lid off.

Benefits

- The cooking position only emits heat when this is necessary to maintain the temperature. This saves energy.
- The temperature is maintained continuously. This prevents the food from boiling over. It also means that you do not have to change the temperature setting.
- Cooking sensor mode will tell you when the water or oil has reached the optimal temperature for adding the food (see the exceptions where the food should be added at the very beginning).

Notes

- Use pans with a thick, flat base. Do not use pans with a thin or deformed base.
- Fill the pan so that the contents reach high enough to cover the cooking sensor's silicone patch.
- Do not remove the cooking sensor from the saucepan during cooking.
- Remove the cooking sensor from the saucepan after cooking. Be careful as the cooking sensor may be very hot.

Tips for cooking with cooking sensor mode

- Keeping warm/heating: Portions of frozen products, e.g. spinach. Place the frozen product in the cookware. Add the volume of water specified by the manufacturer. Cover the cookware with a lid. Select the temperature recommended in the table.
- Poaching: This cooking method is suitable for cooking food at low temperatures, thickening sauces, reducing stews and cooking with milk. Select the temperature recommended in the table for the food you want to cook.
- Boiling: This cooking method allows you to boil water with a lid on without it boiling over. This temperature control allows water to be boiled more efficiently. Select the temperature recommended in the table.
- Cooking in a pressure cooker: Follow the manufacturer's recommendations. After the signal tone sounds, continue cooking for the recommended time. Select the temperature recommended in the table.
- Deep-fat frying: It is recommended that you heat oil with a lid on. Once the signal tone has sounded, remove the lid and add the food. Select the temperature recommended in the table for the food you want to cook.

Notes

- Always cook with the lid on except when using the "Deep-fat frying" function.
- If an audible signal does not sound, make sure there is a lid on the pan. If there is a lid on the pan, the appliance may have reached its maximum power consumption or the *Power management* setting may have been activated. This may affect the time required to reach the selected temperature. Switch off or reduce the temperature of the cooking positions on which the other pans are placed. See the section entitled → "*Basic settings*".
- Never leave oil unattended when it is being heated. Use oil that is suitable for deep-fat frying. Do not mix different cooking fats and oils – e.g. oil and lard – as such mixtures may foam up when hot.
- If you are not satisfied with the cooking result, e.g. when boiling potatoes, next time use more water but keep the recommended temperature setting.



Setting the boiling point

The point at which water starts to boil depends on the height of your home above sea level. If the water is boiling too vigorously or not vigorously enough, you can set the boiling point. Proceed as follows:

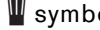

- Touch the  button and select the basic setting *Cooking sensor calibration*.
- The basic setting is set to 200-400 m by default. If your home is between 200 and 400 metres above sea level, you do not need to set the boiling point. If it is not, select the setting that matches your home's height above sea level.

Note: A temperature setting of 100 °C is sufficient for efficient boiling, even if the water does not boil very vigorously. However, the boiling point can be changed. For example, you can set a lower altitude if you want the water to boil more vigorously.

Setting procedure

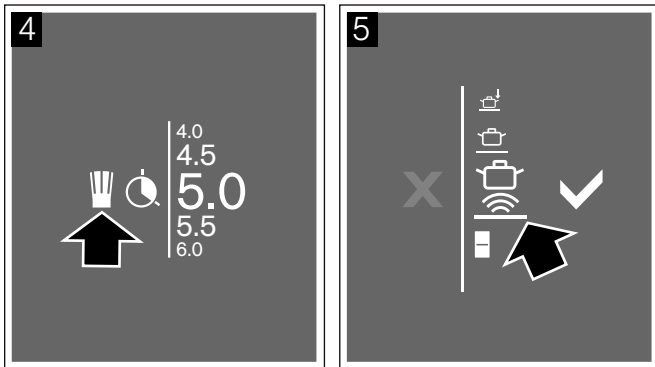
- 1 Attach the cooking sensor to the saucepan; see the section entitled
- 2 Fill the cookware with a sufficient amount of liquid, put the lid on and place it on the cooking surface. See the section entitled → "Fitting the wireless temperature sensor".
- 3 Touch the cooking position display for the cookware.
- 4 Touch the  symbol.
- 5 Use your finger to scroll up to the  symbol. Then touch the  symbol to confirm your choice.



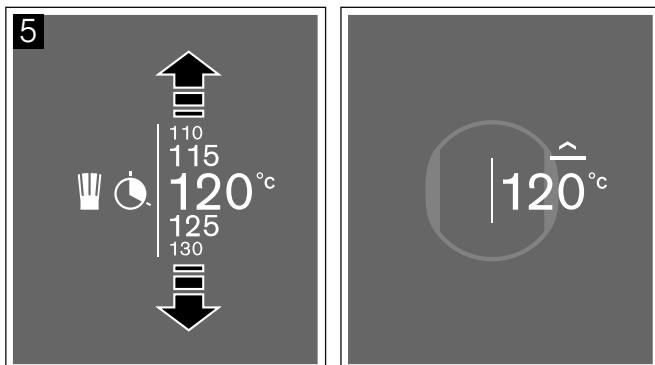

- 6 Touch the  symbol on the wireless cooking sensor as shown on the display.
- 7 Select the temperature setting. Cooking sensor mode is now active. The temperature symbol  next to the cooking position will light up gradually until the selected temperature has been reached. Then an audible signal will sound and the temperature symbol will go out.





- 8 When the signal tone sounds, remove the lid and add the food. Leave the lid on while cooking.

Tip: If you want to set a more precise temperature, it can be increased or decreased by 1 to 5 °C. To do this, touch the selected temperature and then the  symbol.

Then select the required temperature and touch the  symbol to confirm, or touch the  symbol to cancel and exit the menu.

Deactivating

- 1 Tap the temperature setting.
- 2 Touch the  symbol and select a different cookware mode in the settings area.
- 3 Touch the  symbol to confirm your choice.

Cooking sensor mode is deactivated.

Recommended dishes

The following table shows a selection of dishes and is arranged by food type. The temperature and the cooking time depend on the amount, the condition and the quality of the food.

Meat	Temperature	Time (min)
Poaching		
Sausages ¹	90 °C	10 - 20
Boiling		
Meatballs ¹	100 °C	20 - 30
Stewing poultry ¹	100 °C	60 - 90
Viennese boiled beef ¹	100 °C	60 - 90
Cooking in a pressure cooker		
Stewing poultry in a pressure cooker ²	115 °C	15 - 25
Viennese boiled beef in a pressure cooker ²	115 °C	15 - 25
Deep-fat frying		
Deep-fat frying chicken portions ³	170 °C	10 - 15
Deep-fat frying meatballs ³	170 °C	10 - 15
¹ Heat up and cook with the lid on. Add the food after the signal tone sounds.		
² Add the food at the start.		
³ Heat the oil with the lid on. Fry one portion after the other without the lid.		

Fish	Temperature	Time (min)
Poaching		
Braised fish ¹	90 °C	15 - 20
Deep-fat frying		
Deep-fat frying fish in beer batter ²	170 °C	10 - 15
Deep-fat frying breaded fish ²	170 °C	10 - 15
¹ Heat up and cook with the lid on. Add the food after the signal tone sounds.		
² Heat the oil with the lid on. Fry one portion after the other without the lid.		

Egg dishes	Temperature	Time (min)
Boiling		
Boiled eggs ¹	100 °C	5 - 10
¹ Add the food at the start.		

Vegetables and pulses	Temperature	Time (min)
Boiling		
Broccoli ¹	100 °C	10 - 20
Cauliflower ¹	100 °C	10 - 20
Spinach ¹	100 °C	5 - 10
Brussels sprouts ¹	100 °C	30 - 40
Green beans ¹	100 °C	15 - 30
Chickpeas ²	100 °C	60 - 90
Peas ¹	100 °C	15 - 20
Lentils ²	100 °C	45 - 60
Cooking in a pressure cooker		
Vegetables in a pressure cooker ²	115 °C	3 - 6
Chickpeas in a pressure cooker ²	115 °C	25 - 35
Haricot beans in a pressure cooker ²	115 °C	25 - 35
Lentils in a pressure cooker ²	115 °C	10 - 20
Deep-fat frying		
Deep-fat frying breaded vegetables ³	170 °C	4 - 8
Deep-fat frying vegetables in beer batter ³	170 °C	4 - 8
Deep-fat frying breaded mushrooms ³	170 °C	4 - 8
Deep-fat frying mushrooms in beer batter ³	170 °C	4 - 8
¹ Heat up and cook with the lid on. Add the food after the signal tone sounds.		
² Add the food at the start.		
³ Heat the oil with the lid on. Deep-fat fry one portion after the other without the lid.		

Potatoes	Temperature	Time (min)
Poaching		
Cooking potato dumplings ¹	85 °C	30 - 40
Boiling		
Gnocchi ¹	100 °C	3 - 6
Boiling potatoes ²	100 °C	30 - 45
Boiling sweet potatoes ²	100 °C	30 - 45
Cooking in a pressure cooker		
Potatoes in a pressure cooker ²	115 °C	10 - 20
Sweet potatoes in a pressure cooker ²	115 °C	10 - 20
Deep-fat frying		
Potatoes in an aromatic sauce ³	160 °C	8 - 12
¹ Heat up and cook with the lid on. Add the food after the signal tone sounds.		
² Add the food at the start.		
³ Heat the oil with the lid on. Deep-fat fry one portion after the other without the lid.		

Pasta and grains	Temperature	Time (min)
Poaching		
Semolina pudding ³	85 °C	5 - 10
Parboiled rice ¹	90 °C	25 - 35
Brown rice ²	90 °C	45 - 55
Exotic rice (e.g. basmati, Thai) ²	90 °C	8 - 12
Wild rice ²	90 °C	20 - 30
Quinoa ¹	90 °C	10 - 12
Polenta ³	85 °C	3 - 8
Boiling		
Durum wheat pasta ³	100 °C	7 - 10
Fresh pasta ³	100 °C	3 - 5
Wholemeal pasta ³	100 °C	7 - 10
Durum wheat pasta, stuffed ³	100 °C	15 - 20
Fresh pasta, stuffed ³	100 °C	5 - 8
Cooking in a pressure cooker		
Rice in a pressure cooker ²	115 °C	6 - 8
Brown rice in a pressure cooker ²	115 °C	12 - 18
¹ Heat up and cook with the lid on. Add the food after the signal tone sounds.		
² Add the food at the start.		
³ Stir frequently.		
Soups		
Poaching		
Instant creamy soups ²	90 °C	10 - 15
Boiling		
Home-made broths ¹	100 °C	60 - 90
Instant soups ²	100 °C	5 - 10
Cooking in a pressure cooker		
Home-made broths in a pressure cooker ¹	115 °C	20 - 30
¹ Add the food at the start.		
² Stir frequently.		
Desserts		
Poaching		
Rice pudding ³	85 °C	40 - 50
Porridge ³	85 °C	10 - 15
Chocolate pudding ³	85 °C	3 - 5
Boiling		
Compote ¹	100 °C	15 - 25
Deep-fat frying		
Deep-fat frying jam-filled doughnuts ²	160 °C	5 - 10
Deep-fat frying ring doughnuts ²	160 °C	5 - 10
Deep-fat frying buñuelos ²	160 °C	5 - 10
¹ Add the food at the start.		
² Heat the oil with the lid on. Deep-fat fry one portion after the other without the lid.		
³ Stir frequently.		

Frozen products	Temperature	Time (min)
Keeping warm, heating		
Vegetables in cream sauce ⁴	70 °C	15 - 20
Defrosting broths ²	70 °C	15 - 25
Boiling		
Green beans, frozen ¹	100 °C	15 - 30
Deep-fat frying		
Deep-fat frying chips ³	180 °C	4 - 8

¹ Heat up and cook with the lid on. Add the food after the signal tone sounds.

² Add the food at the start.

³ Heat the oil with the lid on. Deep-fat fry one portion after the other without the lid.

⁴ Stir frequently.

Miscellaneous	Temperature	Time (min)
Keeping warm, heating		
Heating goulash soup ¹	70 °C	10 - 20
Heating mulled wine ¹	70 °C	5 - 15
Poaching		
Heating milk ¹	85 °C	3 - 10

¹ Add the food at the start.

Dynamic cooking for an item of cookware

In this function, the default power levels are displayed when cookware is placed on the cooking surface.

This allows you to change the power level during cooking simply by moving the cookware forwards or backwards.

Default heat settings: **1.0, 3.0, 5.0, 7.0** and **9.0**.



To change the default heat settings, see the section entitled → "*Basic settings*".

Notes

- If this function is not available in the settings area, the cookware may be too big. Use a smaller item of cookware.
- If this does not activate when you select the heat setting, the appliance may have reached its maximum power consumption. See *Power management* setting in the section entitled → "*Basic settings*".
- For more information on the size and positioning of the cookware, see the section entitled → "*Induction cooking*".

Activation

Place the cookware on the cooking surface.

- 1 Touch the cooking position display for the cookware.
- 2 Touch the  symbol.
- 3 Use your finger to scroll down to the  symbol. Then touch the  symbol to confirm your choice.

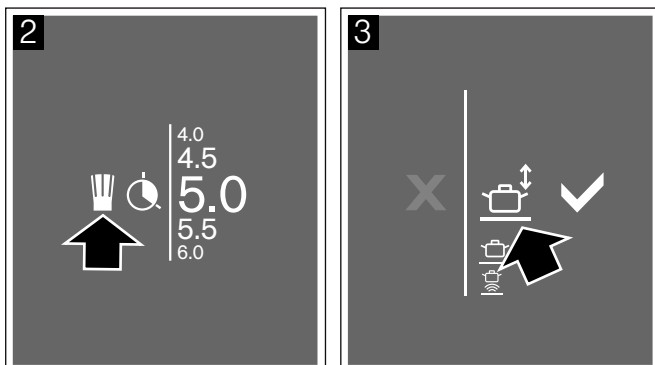

The function has now been activated.

- 4 Move the cookware over the cooking surface until the power level you require is set. The power level you have selected will appear on the cooking position display.

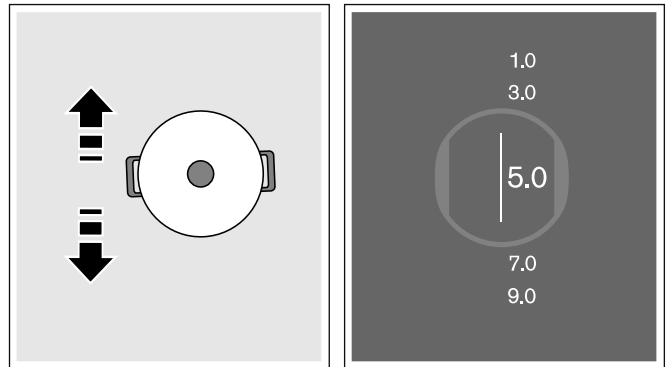



Changing the heat setting

You can change the power levels while you are cooking. To choose a different power level in the programming area, touch the area you want to change the power level of.

Note: If the function is deactivated, the power levels will return to the default values

Deactivating

- 1 Touch the power level.
- 2 Touch the  symbol and select a different cookware mode in the settings area.
- 3 Touch the  symbol to confirm your choice.

This function has now been deactivated. The power level you selected previously will be retained.

Teppanyaki mode

This mode allows you to split the surface of the teppanyaki into two halves: A hot area to which a heat setting is assigned, and an area to which no heat setting is assigned.

You can change the heat settings during cooking.

Note: If this mode is not available in the settings area, the cookware may be too big. Use a smaller item of cookware.

Suitable cookware







Teppanyakis are available that are perfectly suited to this mode. These can be purchased from specialist retailers or through our technical after-sales service or our official website. Quote the relevant reference number:

- GN232110 griddle plate, dimensions 325 x 530 mm
- CA051300 griddle plate, dimensions 265 x 415 mm

Activation

Place the cookware on the cooking surface horizontally or vertically.

- 1 Tap the cooking position display for the cookware.
- 2 Touch the  symbol.
- 3 Scroll upwards with your finger until you reach the symbol for the teppanyaki grill on the cooking surface.

Symbol	Position
	Vertical position, two cooking positions warm
	Vertical position, bottom cooking position warm
	Vertical position, top cooking position warm
	Horizontal position, two cooking positions warm
	Horizontal position, right-hand cooking position warm
	Horizontal position, left-hand cooking position warm

Note: Only the available symbols for the size of the teppanyaki grill and its position on the cooking surface are displayed.

Then touch the  symbol to confirm your choice.

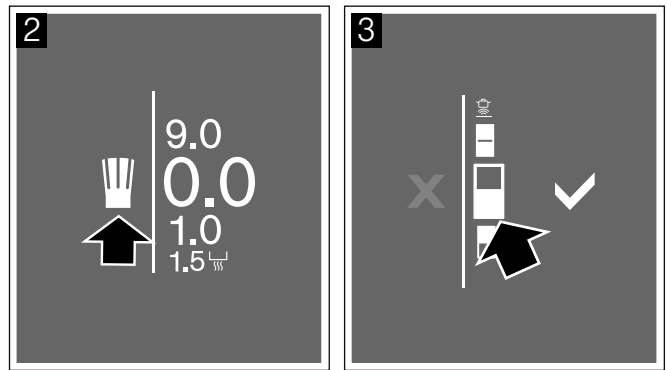

- 4 Select the heat setting you require from the settings area.

The display will show the orientation of the teppanyaki grill with the power level selected for the cooking position or the entire area the cookware is taking up. The symbol for residual heat  will appear on the cooking position to which no power level has been assigned.

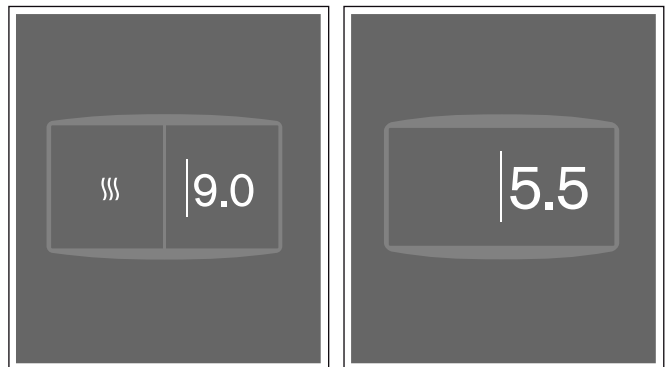



The mode is active.

Changing the heat setting

Touch the assigned area of the heat setting and use your finger to scroll up or down to the heat setting you require.

Note: If the orientation of the teppanyaki is changed, select the appropriate option for the new position on the cooking surface.

Deactivating

- 1 Touch the power level.
- 2 Touch the  symbol and select a different cookware mode in the settings area.
- 3 Touch the  symbol to confirm your choice.

The mode is deactivated.



Childproof lock

The childproof lock lets you lock the hob so that it cannot be switched on accidentally.

Note: You will not be able to activate the childproof lock if any of the cooking positions are switched on.

Activation



The hob must be switched on.

Touch and hold the  symbol for approx. 4 seconds. The  symbol lights up.

The childproof lock is activated. The hob is now locked.

Deactivating

The hob must be switched on.

Touch and hold the  symbol for approx. 4 seconds. The  symbol will light up.

This deactivates the childproof lock. The hob is now enabled.

Childproof lock

With this function, the childproof lock automatically activates when a hob is switched off.

Switching on and off

You can find out how to switch the automatic childproof lock on in the → *"Basic settings"* section

Note: To deactivate the automatic childproof lock, touch and hold the  symbol for approx. 4 seconds.

Pause function

While the pause function is active, the settings you have selected appear on the touchscreen display. The heat setting(s) is/are switched off, however, and the cooking time(s) you have set have stopped.

If the timer or stopwatch is active, it will continue running. If the pause function has been activated, the timer duration cannot be changed.

The pause function has no effect on the main switch. You can still switch off the hob at any time.



Activation

Touch the  symbol. The hob will remain locked for 30 minutes. You can now clean the surface of the touchscreen display, for example, without altering the settings.

Note: The  symbol will be displayed in the function bar when cooking is started.

Deactivating

The cooking position automatically switches off after 30 minutes.

To switch the function off before 30 minutes have elapsed, touch the  symbol and then the  symbol to confirm.

Note: If you move the cookware across the cooking surface while the function is still activated, the settings may be lost.

Automatic safety cut-out

If a cooking position is in operation for a long time and none of the settings are changed, the automatic safety switch-off function is activated.

















The cooking zone will stop heating and a notification will appear on the display.

Touch the  symbol. You can now reprogram the cooking position.

The point at which the automatic safety switch-off function is activated depends on the power level that has been set (after 1 to 10 hours).

Basic settings

The appliance has various basic settings. You can adapt these settings to your personal requirements.

Settings	Description and options
 Brightness	You can change the brightness of the touchscreen display.
 Start screen	You can choose whether or not the brand logo will be displayed when you switch on the hob.
 Sounds	You can select which signal tones you want the appliance to use.
kW Power management	You can restrict the hob's total power and adapt it to the local mains connection.
 Professional cooking – power levels	You can change the default heat settings of the cooking areas for professional cooking mode.
 Dynamic cooking – power levels	You can change the default heat settings of the cooking areas for dynamic cooking mode.
 Single dynamic cooking – power levels	You can change the default heat settings of the cooking areas for dynamic cooking mode for an item of cookware.
CAL Cooking sensor calibration	Set your height above sea level to adjust the boiling point.
 Cooking sensor pairing	Connect the wireless cooking sensor to the hob.
 Temperature format	You can change the temperature format.
 Language	You can change the language used on the display.
 Start mode	Select the cooking mode that you want the hob to start with.
 Appliance index and fabrication date	You can view information about your appliance.
 Automatic restore	You can set how long the appliance saves the most recently used settings after it has been switched off.
 Presettings	You can restore all settings to the factory settings.
 Childproof lock	You can use the childproof lock to disable the hob and prevent children from using it without supervision.
 Hood control	The ventilation system can be controlled from the hob either by connecting the appliances to your home network or by directly connecting the ventilation system to the hob.
 Home network	The hob can be logged into your home network automatically (via WPS) or manually.

To go to the basic settings

All cooking positions must be deactivated.

- 1 Touch the  symbol. The basic settings menu will appear on the display.
- 2 The default setting is *Brightness*. To select a different setting, scroll left or right with your finger.

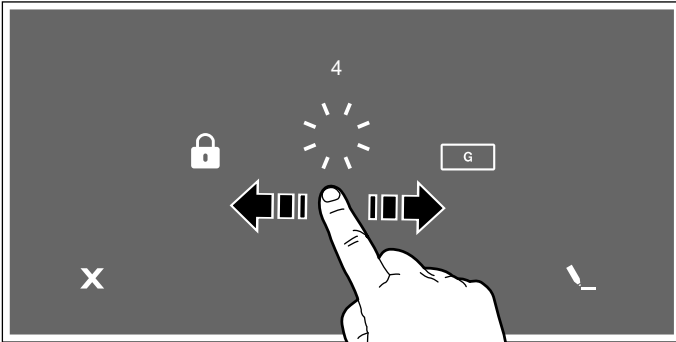

- 3 To change the selected setting, touch the  symbol.

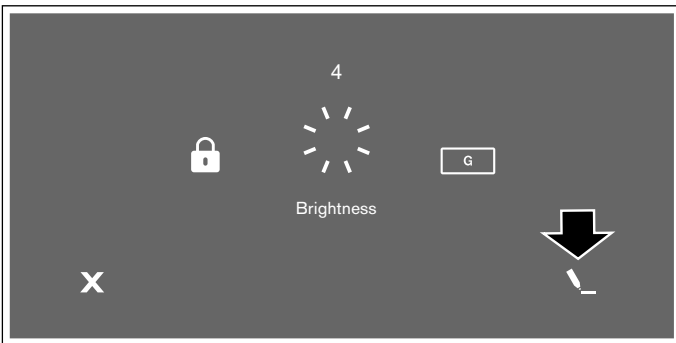

- 4 Change the selected setting.

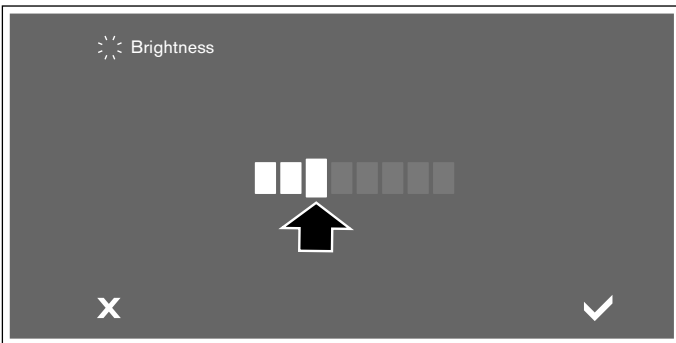

- 5 Touch the  symbol to confirm the selection. The settings are saved.
To cancel and exit the menu, touch the **X** symbol.

Exiting the basic settings menu

To exit the basic settings, touch the  symbol on the main switch.

Home Connect

This appliance is WLAN-enabled and settings can be sent to the appliance via a mobile device.

If the appliance is not connected to the home network, the appliance functions in the same way as a hob with no network connection. The hob can always be operated via the control panel.

The availability of the Home Connect function depends on the availability of Home Connect services in your country. Home Connect services are not available in every country. You can find more information on this at www.home-connect.com.

Notes

- Hobs are not designed to be used unattended - you must always keep an eye on the cooking process.
- Ensure that you follow the safety instructions in this instruction manual and that these are also observed when operating the appliance via the Home Connect app. You must also follow the instructions in the Home Connect app. → "Important safety information" on page 5
- Using the Home Connect app, you can send settings to your appliance and then have to confirm them on the appliance. It is not possible to operate the appliance whilst you are away from home.
- Operation on the appliance always has priority. During this time, it is not possible to operate the appliance using the Home Connect app.

Connection to your home network

To implement settings via Home Connect, you must have installed and set up the Home Connect app on your mobile device.

Refer to the Home Connect documents supplied for more information.

The appliances must be connected to the same home network.

Setting up the Home Connect app

Note: You require a mobile device with the latest version of the relevant operating system.

- 1 On your mobile device go to the App Store (Apple devices) or to the Google Play Store (Android devices).
- 2 Enter "Home Connect" in the search field.
- 3 Select the Home Connect app and install on your mobile device.
- 4 Start the app and create your Home Connect login details. The app will guide you through the registration process. Make a note of your e-mail address and password.



Automatic registration in the home network

You require a router that has WPS functionality.

Access to the router is required. If you do not have this, follow the steps under "Manually logging into your home network".

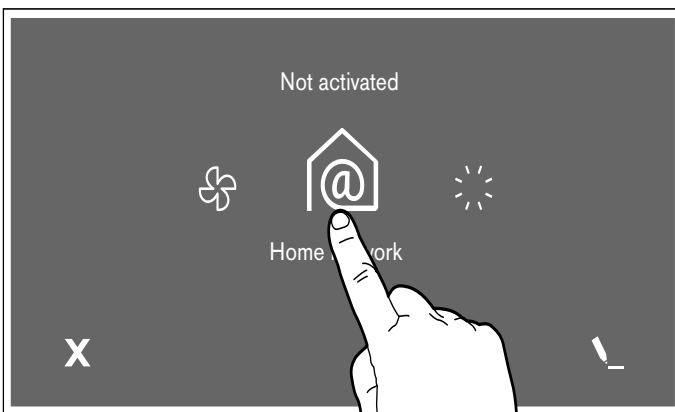
- 1 To open the basic settings, touch the  symbol on the main screen.
- 2 Scroll left or right with your finger and select the *Home network* setting.



- 3 The requirements for connecting to Home Connect are displayed. Touch the  symbol to confirm.
- 4 Select the *Automatic (WPS)* option and then touch the  symbol to confirm your choice.
- 5 You have 2 minutes to tap the WPS button on the router, as indicated on the display.

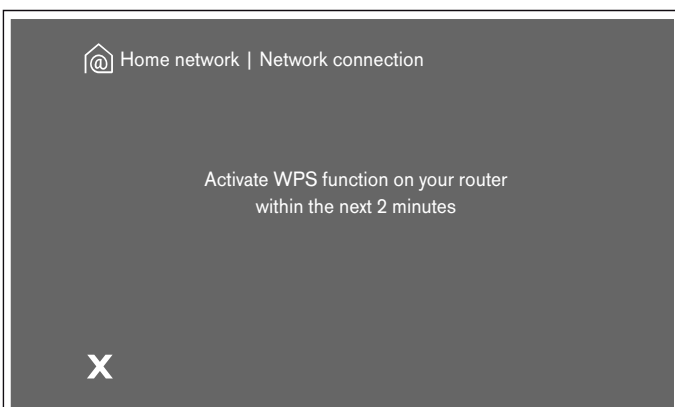

- 6 A message will be displayed to notify you when the hob is successfully connected to your home network. Touch the  symbol to confirm.

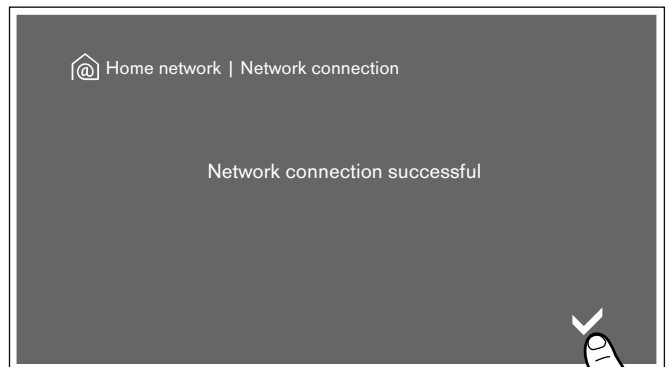

- 7 Then, open the Home Connect app on your mobile device and follow the instructions for establishing the connection on the display.
- 8 A message will be displayed to notify you when connection to the app has been successful. Touch the  symbol to confirm.

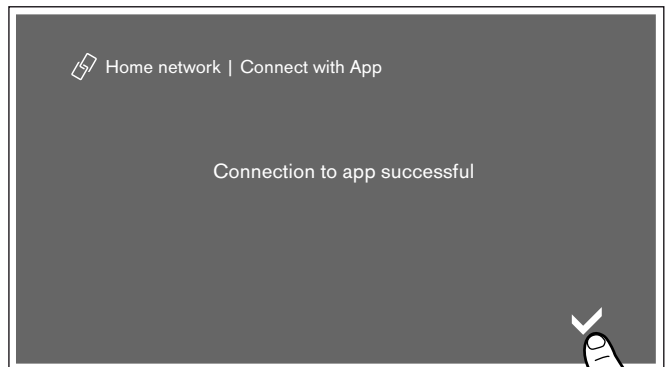

The basic settings menu will reappear on the display, with information on the type of connection and strength of the connection to your home network. Touch the **X** symbol to return to the main screen or select the *Home network* setting to go to the Home Connect settings.

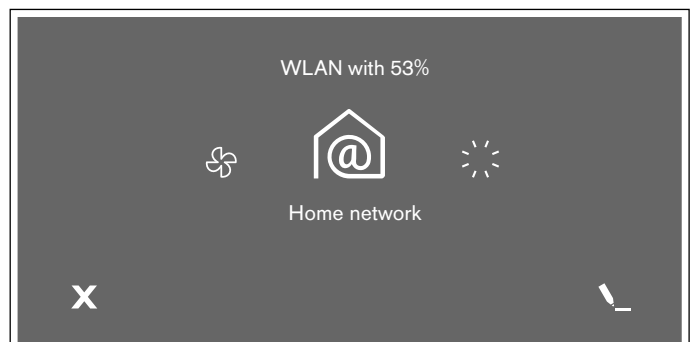





The  symbol will appear on the main screen.

Note: If it is unable to connect, relaunch the assistant or manually log the appliance into your home network.

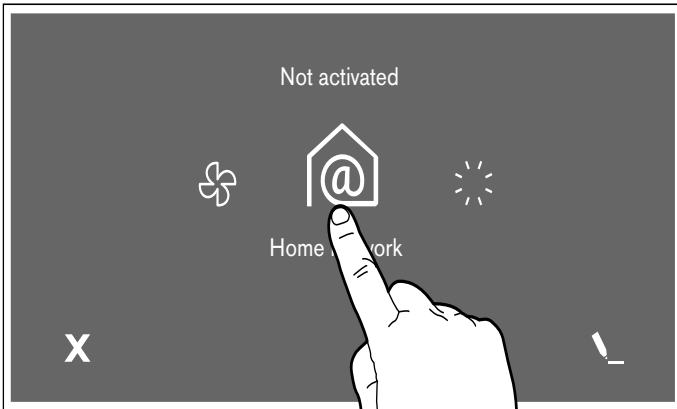
Manual registration in the home network

- 1 To open the basic settings, touch the  symbol on the main screen.
- 2 Scroll left or right with your finger and select the *Home network* setting.



- 3 The requirements for connecting to Home Connect are displayed. Touch the  symbol to confirm.
- 4 Select the *Manual* option and then touch the  symbol to confirm your choice.
- 5 A message will appear on the display that allows you to open the network settings on your mobile device. Touch the  symbol to confirm.
- 6 You have 5 minutes to log in your mobile device using the SSID "HomeConnect" and password "HomeConnect".

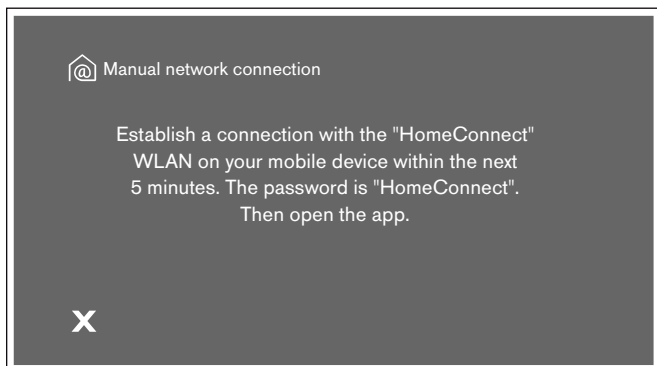

- 7 Then, open the Home Connect app on your mobile device.

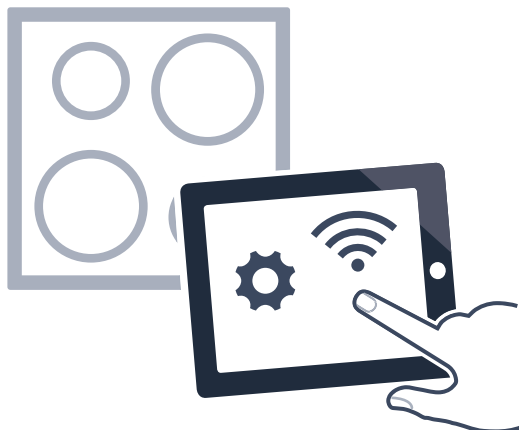

- 8 A message will be displayed to notify you when the hob is successfully connected to your home network. Touch the  symbol to confirm.

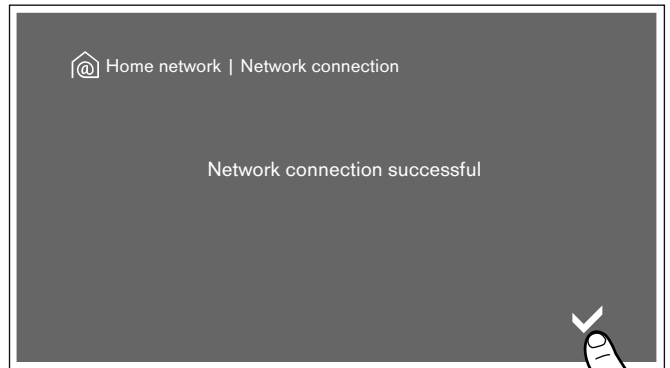

- 9 Then, open the Home Connect app on your mobile device and follow the instructions for establishing the connection on the display.
- 10 A message will be displayed to notify you when connection to the app has been successful. Touch the  symbol to confirm.

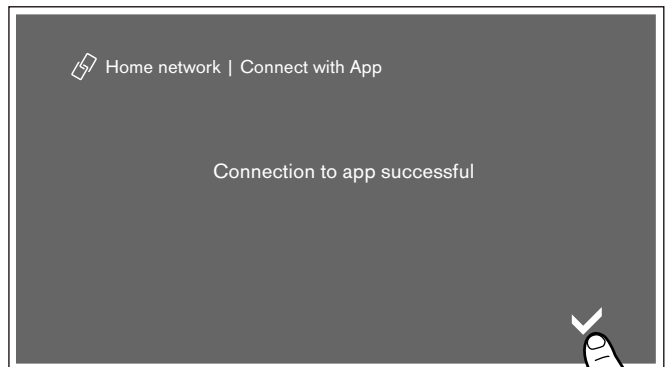

The basic settings menu will reappear on the display, with information on the type of connection and strength of the connection to your home network. Touch the **X** symbol to return to the main screen or select the *Home network* setting to go to the Home Connect settings.

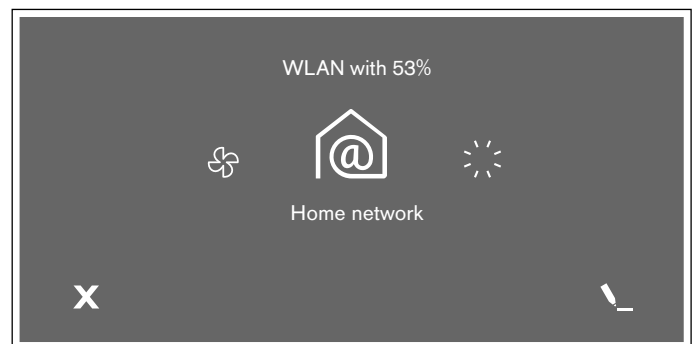





The  symbol will appear on the main screen.

Note: If it is unable to connect, relaunch the assistant or manually log the appliance into your home network.

Home Connect settings

You can adjust Home Connect to suit your requirements at any time.









In the basic settings for your hob, navigate to the Home Connect settings to display network and appliance information.

Settings	Description
 Connection	Enables the Wi-Fi network to be switched on and off.
 Connect with App	You can connect to one or more Home Connect accounts.
 Settings via the app	You can choose whether to allow cooking settings to be sent.
 Delete network settings	Delete all network settings from appliance

Note: The *Connection* setting is only displayed if there is currently no connection to your home network. All other settings are only displayed if the appliance is already connected to your home network.

Wi-Fi symbols

The Wi-Fi indicator on the main control panel changes depending on the status of the connection and the availability of the Home Connect server.

Symbol	Description
	Home network available and settings in the app enabled
	Home network available and settings in the app disabled
	Not connected to the Home Connect server and settings in the app enabled
	Not connected to the Home Connect server and settings in the app disabled
	No Wi-Fi network available and settings in the app enabled
	No Wi-Fi network available and settings in the app disabled
	Remote maintenance performed and Wi-Fi network available
	Remote maintenance performed and no Wi-Fi network available

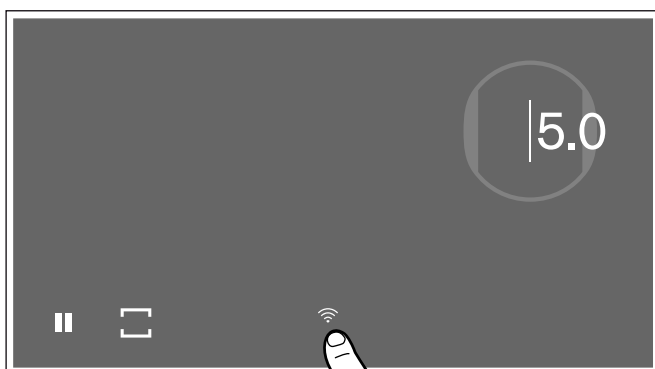

Deactivating Wi-Fi

The Home Connect function can be used as long as Wi-Fi has been activated.

Note: In networked standby mode, the appliance requires a maximum of 2 W.

To deactivate Wi-Fi, proceed as follows:

- 1 To open the basic settings, touch the  symbol on the main screen.
- 2 Scroll left or right with your finger and select the *Home network* setting.
- 3 Select the *Connection* option.

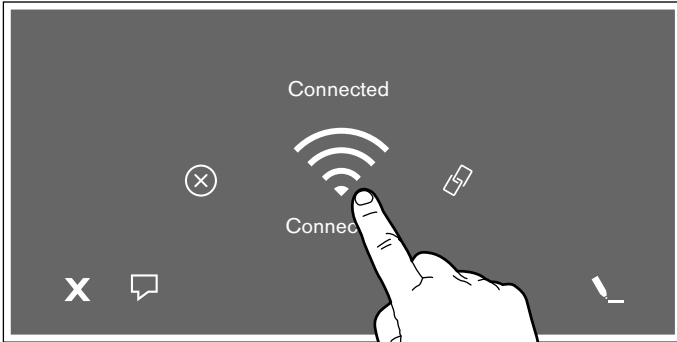

- 4 Select the *Not connected* option.

This deactivates Wi-Fi; the  symbol will go out on the control panel.

Disconnecting from your home network

You can disconnect the hob from the network at any time.

Note: If the hob is disconnected from the network, it is not possible to operate it using Home Connect.

- 1 To open the basic settings, touch the  symbol on the main screen.
- 2 Scroll left or right with your finger and select the *Home network* setting.
- 3 Select *Delete network settings*.

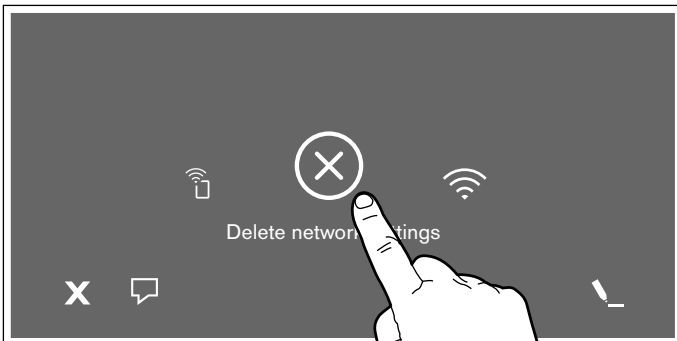

- 4 Touch the  symbol to confirm your choice.

This disconnects the appliance from your home network; the  symbol will go out on the control panel.

Note: The network connection will also be deleted if you restore the factory settings on your appliance.

Connecting to your home network

- 1 To open the basic settings, touch the  symbol on the main screen.
- 2 Scroll left or right with your finger and select the *Home network* setting.
- 3 Select *Connection*.
- 4 Follow the instructions in the section entitled "Manually logging into your home network" or "Automatic login to your home network".

Connect to the app

If the Home Connect app is installed on your mobile device, you can connect it to the hob.

You can connect more than one mobile device to the hob.

Notes

- The appliance must be connected to your home network.
- The Home Connect app must be opened and configured on your mobile device.
- If your extractor hood is directly connected, first disconnect the hob from your home network and then repeat the connection process.

- 1 To open the basic settings, touch the  symbol on the main screen.
- 2 Scroll left or right with your finger and select the *Home network* setting.
- 3 Touch *Connect with App*.

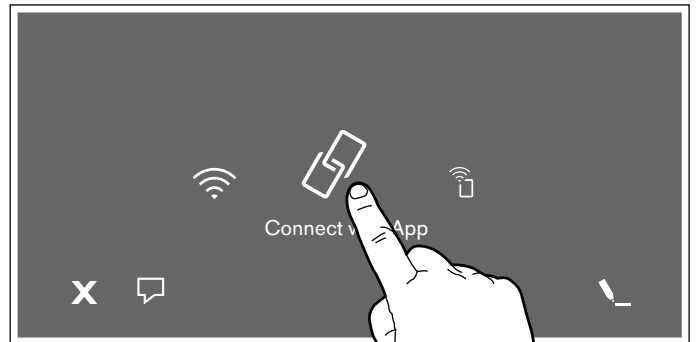

An additional Home Connect account can be connected to the hob. To do this, touch *Connect with App*.

- 4 Follow the instructions in the app to complete the connection process.

Settings via app

Using the Home Connect app, you can easily access the basic settings for your hob and send settings for the cooking positions to the hob.

Notes

- If the appliance is being operated by means of the controls on the appliance itself, this mode of operation always has priority. When the controls on the appliance itself are being used, you will not be able to operate it via the Home Connect app.
 - The transfer settings option is activated by default.
 - If the settings transfer option has been deactivated, only the hob's operating statuses will be displayed in the Home Connect app.
- 1 To open the basic settings, touch the  symbol on the main screen.
 - 2 Scroll left or right with your finger and select the *Home network* setting.
 - 3 Touch *Settings via App*.

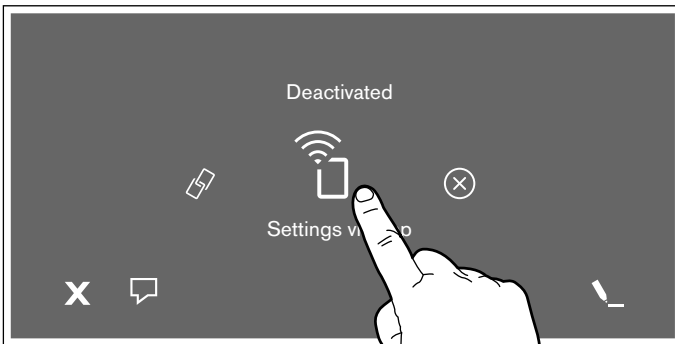

- 4 To activate the settings transfer option, touch *Yes*; to deactivate the settings transfer option, touch *No*.

Confirming settings

Once the settings have been transferred to a cooking position, a confirmation message will appear on the hob's touchscreen display.

Software update

Using the software update function, the hob's software can be updated (e.g. for the purpose of optimisation, troubleshooting or security updates). To use the app, you must first register as a Home Connect user, install the app on your mobile device and connect to the Home Connect server.

The Home Connect app will tell you when a software update is available. You can start the software update via the app or the hob. To do this, refer to the instructions on the display.

Once the update has been successfully downloaded, you can install it via the Home Connect app if you are connected to your local area network.

The Home Connect app will notify you when the update has been successfully installed.

Notes

- You can continue to use the hob as normal while updates are downloading.
- Depending on your personal settings in the app, software updates can also be set to download automatically.
- We recommend that you install security updates as soon as possible.

Remote diagnostics

If a fault occurs, the after-sales service can use remote diagnostics to access your appliance.

Contact the after-sales service, making sure that your appliance is connected to the Home Connect server and checking that the remote diagnostics service is available in your country.

Note: For more information and to check whether the remote diagnostics service is available in your country, please visit the Help & Support area of the Home Connect website for your country: www.home-connect.com

About data protection

When your appliance is connected for the first time to a WLAN network, which is connected to the Internet, your appliance transmits the following categories of data to the Home Connect server (initial registration):

- Unique appliance identification (consisting of appliance codes as well as the MAC address of the installed WiFi communication module).
- Security certificate of the WiFi communication module (to ensure a secure IT connection).
- The current software and hardware version of your domestic appliance.
- Status of any previous resetting to factory settings.

This initial registration prepares the Home Connect functions for use and is only required when you want to use these Home Connect functions for the first time.

Note: Ensure that the Home Connect functions can be used only in conjunction with the Home Connect app. Information on data protection can be accessed in the Home Connect app.

Declaration of Conformity

Gaggenau Hausgeräte GmbH hereby declares that the appliance which features Home Connect is in accordance with the basic requirements and the other relevant provisions of the directive 2014/53/EU.

A detailed RED Declaration of Conformity can be found online at www.gaggenau.com on the product page for appliance in the additional documents.



2.4 GHz band: max. 100 mW
5 GHz band: max. 100 mW

	BE	BG	CZ	DK	DE	EE	IE	EL
	ES	FR	HR	IT	CY	LV	LT	LU
	HU	MT	NL	AT	PL	PT	RO	SI
	SK	FI	SE	UK	NO	CH	TR	

5 GHz Wi-Fi: for indoor use only

Hood control

You can connect this appliance to a suitable extractor hood and then control the functions of the hood via your hob.

There are various options for connecting the appliances together:

Home Connect

Two appliances can be connected using the Home Connect app provided that both of them are Home Connect-compatible.

Refer to the Home Connect documents supplied for more information.



Connecting appliances directly

If the appliance is connected directly to an extractor hood, it cannot be connected to your home network as well. The appliance functions as a hob with no network connection. The hob can always be operated via the control panel.

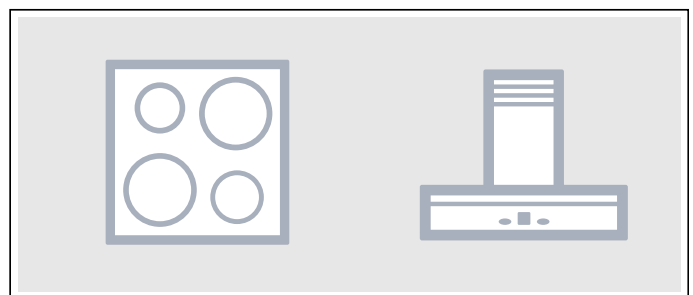

Connecting appliances via your home network

If the appliances are connected to each other via your home network, both the hood controls and Home Connect can be used to operate the hob.

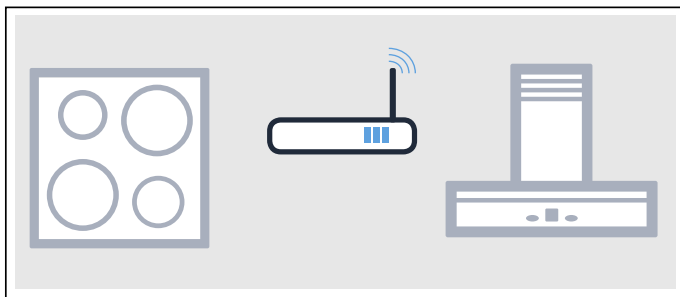

Notes

- Make sure you follow the safety instructions in the instruction manual for your extractor hood and that these are complied with even when operating the appliance via the hood controls on the hob. → "Important safety information" on page 5
- If the appliance is being operated by means of the controls on the extractor hood, this mode of operation always has priority. It is not possible to use the hood controls on the hob during this time.
- In networked standby mode, your appliance requires a maximum of 2 W.

Setting up



To set up the connection between the hob and cooker hood, the hob must be switched on.

Connecting directly

Make sure that the extractor hood is switched off.

For more information refer to the section entitled "Connecting to the hob" in the instruction manual for your extractor hood.

Note: If you connect your hob directly to the extractor hood, it cannot be connected to your home network as well and you will not be able to use Home Connect.

- 1 To open the basic settings, touch the  symbol on the main screen.
- 2 Scroll left or right with your finger and select the *Hood control* setting .
- 3 Select the *Hood control* option and then touch the  symbol to confirm your choice.
- 4 You have 2 minutes to initiate the connection process on the extractor hood. See extractor hood operating instructions.

Once the process is complete, a message will be displayed, informing you of the result of the connection process. If the connection has been successfully established, the  symbol for ventilation control from the hob will appear on the main screen.



If you wish to change the setting, select the *Hood control* option  again and then change the setting as required.

Connecting via your home network

You require a router that has WPS functionality.

Access to your router is required. If you do not have this, follow the steps listed under "Direct connection".

When you begin, make sure that the extractor hood is connected to the same home network.





- 1 To open the basic settings, touch the  symbol on the main screen.
- 2 Scroll left or right with your finger and select the *Hood control* setting .
- 3 Select the *Home network* option and then touch the  symbol to confirm your choice.
- 4 Press the WPS button on the router within the next 2 minutes.
A message will be displayed to notify you when the hob is successfully connected to your home network.
- 5 You have 2 minutes to initiate the connection process on the extractor hood. See extractor hood operating instructions.

Once the process is complete, a message will be displayed, informing you of the result of the connection process. If the connection has been successfully established, the  symbol for ventilation control from the hob will appear on the main screen.

Note: Connection can only be established when both appliances are connected to your home network and the connection process has been initiated for both of them. If the time allowed for connecting has already expired for one of the two appliances, initiate the connection process again.

Disconnecting from the network

The connection to the home network can be deleted.

- 1 To open the basic settings, touch the  symbol on the main screen.
- 2 Scroll left or right with your finger and select the *Hood control* setting .
- 3 Select the *Disconnect Hood control* option  and then touch the  symbol to confirm your choice.

The connections have now been deleted.

Note: The connection to the home network can be re-established at any time.

Control the hood via the hob

In the hob's basic settings, you can configure what the extractor hood should do when the hob or individual cooking positions are switched on or off.

You can select other settings using the control panel.

Setting the fan

Activation

- 1 Touch the  symbol on the main screen.
- 2 Select the fan setting in the settings area. The following settings are possible:

0	Fan off
1, 2, 3	Fan settings. Intensity: Low, medium, high
»	Intensive mode

The following will also be displayed, depending on which ventilation control setting is selected:

A	Automatic mode
⌚	Fan run-on
U	Unknown mode



The selected setting will appear on the main screen next to the  symbol.

Deactivating

Select fan setting 0.

Setting automatic mode

Activation

- 1 Touch the  symbol on the main screen.
- 2 Select the  *Hood control* option.
- 3 Select the **A** *Automatic* option.



Depending on how the extractor hood sensor is configured, the fan will start automatically when it detects smoke. For additional information, see extractor hood operating instructions.

Deactivating

- 1 Touch the  symbol on the main screen.
- 2 Select a different fan setting.

Setting the hood lighting

The hood light can be switched on and off using the control panel for the cooktop.





- 1 Touch the  symbol on the main screen.
- 2 Select the  *Brightness* option.
- 3 Select the brightness level.

Depending on the basic settings you have selected, the light is automatically switched on or off when the hob is switched on or off.

Ventilation control settings

You can adapt the hood controls on the hob to suit your needs at any time.

Note: The settings will only be displayed if the appliance is connected to an extractor hood.

Settings	Description
 Automatic control	You can choose the fan setting at which the extractor hood runs when the hob is switched on.
 Run-on function	The run-on function keeps the fan running for a certain amount of time after the hob is switched off.
 Brightness	You can choose the brightness setting at which the extractor hood light lights up when the hob is switched on.
 Automatic switch off	You can choose whether the extractor hood light is automatically switched off when the hob is switched off.
 Disconnect Hood control	The connection to the home network can be deleted.

Some of these settings may not be available

Cleaning

Suitable maintenance and cleaning products can be purchased from the after-sales service or in our e-Shop.

Hob

Cleaning

Always clean the hob after cooking. This will prevent food deposits from becoming burned on. Only clean the hob after the residual heat indicator has gone out.

Clean the hob with a damp dish cloth and dry it with a cloth or towel to prevent limescale build-up.

Only use cleaning agents that are suitable for this type of hob. Observe the manufacturer's instructions on the product packaging.

Never use:

- Undiluted washing-up liquid
- Cleaning agents designed for dishwashers
- Abrasive cleaners
- Harsh cleaning agents, such as oven spray and limescale remover
- Scouring pads
- High-pressure cleaners or steam jet cleaners

Stubborn dirt is best removed with a glass scraper, available from retailers. Observe the manufacturer's instructions.

You can obtain a suitable glass scraper from customer services or through our online shop.

Using a special sponge for cleaning glass-ceramic hobs achieves a great cleaning result.

Potential marks

Limescale and water marks	Clean the hob as soon as it has cooled down. You can use a cleaning agent suitable for glass-ceramic hobs.*
Sugar, rice starch or plastic	Clean immediately. Use a glass scraper. Caution: Risk of burns.*

* Then clean with a damp dish cloth and dry with a cloth or towel.

Note: Do not use any cleaning agents while the hob is still hot. This may mark the surface. Make sure that any residue left by cleaning agents is removed.

Hob surround

To prevent damage to the hob surround, observe the following instructions:

- Only use warm soapy water
- Wash new dish cloths thoroughly before use.
- Do not use harsh or abrasive cleaning agents.
- Do not use a glass scraper or sharp objects.

Frequently Asked Questions (FAQ)

Use

Nothing appears in the display.

The brightness may not be set correctly. Look at the display from above and set the brightness in the basic settings.

For more information about the settings, see the section entitled → *"Basic settings"*.

The main display shows a warning message and a signal tone sounds.

Remove any liquid or remnants of food from the control panel. Remove any objects from the control panel.

For instructions on how to deactivate the signal tone, see the section entitled → *"Basic settings"*.

Noises

Why can I hear noises while I'm cooking?

Noises may be generated while using the hob depending on the base material of the cookware. These noises are normal for induction technology. They do not indicate that there is a fault.

Possible noises:

A low humming noise of the kind a transformer makes:

Occurs when cooking at a high power level. The noise disappears or becomes quieter when the power level is reduced.

Quiet humming:

The cookware may be too small for the cooking position or not suitable for induction cooking. Use a bigger item of cookware or move it to a different position on the cooking surface.

Quiet whistling:

This happens when the cookware is empty. The noise disappears when water or food is added to the cookware.

High-pitched whistling noises:

These may occur if two cooking positions are used at the highest power level at the same time. The whistling noises disappear or become quieter when the power level is reduced.

Crackling:

This occurs when using cookware made from layers of different material or when using cookware of different sizes and different materials at the same time. How loud the noise is may vary depending on the quantity of food you are cooking and the method you are using.

Fan noise:

The hob is equipped with a fan that automatically switches on at high temperatures. The fan may continue to run even after you have switched off the hob if the temperature detected is still too high.

Clicking:

Occasional clicking when activating or moving an item of cookware is completely normal.

Now and again, other completely random noises that have nothing to do with the cookware may occur.

Cookware

Which types of cookware can be used with an induction hob?

For information on which types of cookware can be used with an induction hob, see the section entitled → *"Induction cooking"*.

Why is the hob not heating up?

Make sure that the cookware is suitable for use with an induction hob. For information on the type, size and positioning of the cookware, see the section entitled → *"Induction cooking"*.

Why is it taking so long for the cookware to heat up or why is it not heating up correctly despite being on a high power level?

Make sure that the cookware is suitable for use with an induction hob. For information on the type, size and positioning of the cookware, see the section entitled → *"Induction cooking"*.

The depiction of the cookware on the touchscreen display does not match the actual cookware in terms of size and shape.

The depiction of the cookware on the touchscreen display is purely indicative.

Make sure that the item of cookware is inside the usable area of the cooking surface.

There is cookware on the cooking surface that is not being shown on the touchscreen display.

There are more than eight items of cookware on the cooking surface.

The cookware is too small: A diameter of between 90 and 340 mm is recommended.

Use a bigger item of cookware or cookware that is suitable for induction cooking. Alternatively, move the cookware to a different position on the cooking surface. For information on which types of cookware can be used with an induction hob, see the section entitled → "*Induction cooking*".

There are two items of cookware on the cooking surface. However, the touchscreen display displays this as just one item of cookware.

If two pots or pans are placed very close together on the cooking surface, the touchscreen display may depict them as one item of cookware.

Move the two items away from each other until the touchscreen display depicts them separately.

There is an item of cookware on the cooking surface. However, the touchscreen display depicts two or more.

The base of the cookware may be deformed or embossed, or the cookware is not suitable for induction cooking.

Check how flat the base of the cookware is and place it back on the cooking surface. For information on the type, size and positioning of the cookware, see the section entitled → "*Induction cooking*".

Not every item of cookware that is on the cooking surface can be activated.

You can place up to eight items of cookware on the cooking surface but only up to five evenly distributed items can be used at the same time.

For information on positioning cookware, see the section entitled → "*Induction cooking*".

You can cook with up to three items of cookware on one side. If there is an item of cookware in the centre of the cooking surface or an item of cookware is too large, the number of "active" pots or pans is restricted.

For information on positioning cookware, see the section entitled → "*Induction cooking*".

One of the items of cookware is not suitable for induction cooking. The ⊖ symbol appears on the touchscreen display next to the unsuitable pot or pan.

For information on which types of cookware can be used with an induction hob, see the section entitled → "*Induction cooking*".

The appliance has exceeded its maximum power consumption or the Power management setting has been activated.

Check the installation and correctly configure the Power management setting. See the section entitled → "*Basic settings*".

The heat setting cannot be increased.

The appliance has reached its maximum power consumption or the Power management setting has been activated.

Switch the positions of the cookware on the cooking surface. Check the installation and correctly configure the Power management setting. See the section entitled → "*Basic settings*".

The Cooking sensor mode is not available.

The appliance has reached its maximum power consumption or the Power management setting has been activated.

To ensure that the Cooking sensor mode is available, switch off the other cooking positions or reduce the heat setting for the other items of cookware. Switch the positions of the cookware on the cooking surface. Check the installation and correctly configure the Power management setting. See the section entitled → "*Basic settings*".

Bubbles are forming with an uneven distribution within the cookware.

Depending on the power level that is selected, the type of cookware or the combination with other cookware, bubbles may form unevenly. This does not affect the temperature or the cooking process.

For information on the type, size and positioning of the cookware, see the section entitled → "*Induction cooking*".

Cleaning

How do I clean the hob?

You can achieve the best results by using special glass-ceramic cleaning products. Do not use any harsh or abrasive cleaning products, dishwasher detergent (concentrated) or scouring pads.

For more information on cleaning and caring for your hob, see the section entitled → *"Cleaning"*.

Home network

Why will the hob not connect to the home network after the WPS button has been pressed on the router?

Once the "Connect automatically" option has been selected, press the WPS button on the router within the next two minutes.

If this time has already elapsed, repeat the connection procedure. If the problems persist, restore the appliance to factory settings; see section → *"Basic settings"*.

Why is my mobile device not logging into the Home Connect network?

Use the SSID "HomeConnect" and password "HomeConnect" to connect.

Make sure that you have entered all the characters correctly and that you have used upper and lower case in the relevant places.

Trouble shooting

If a problem or fault occurs in the appliance, instructions, alerts, warnings or fault messages will be shown on the display.

Warnings and fault messages

Warnings are displayed if an internal fault has occurred that will compromise use of the hob.

Follow the instructions on the display and touch the ✓ symbol to return to the main screen.

Fault messages are displayed if an internal fault or malfunction has occurred that makes it impossible to use the hob.

Tips

Problem	Solution
The hob will not switch on.	Use other electrical appliances to check whether a short circuit has occurred in the power supply. Make sure that the appliance has been connected as shown in the circuit diagram. If the fault cannot be rectified, inform the technical after-sales service.
The touchscreen display is not responding or has frozen. The touchscreen display is not responding or has frozen.	The control panel is damp or there is something on it. Dry the control panel or remove the object.
The cooking zone's power level cannot be increased.	The hob's total power output has been limited. Change the total power under "Maximum power consumption" in the basic settings. If a very large item of cookware is being used, this may have an effect on the maximum power level for that half of the hob. Set down the cookware again.
An audible signal sounds if there is something on the touchscreen display.	Remove the object and reset the hob. Do not place hot cookware on the control panel.
The hob responds in an unusual manner or cannot be operated properly.	Switch the appliance off using the main fuse or the circuit breaker in the fuse box. Wait a few seconds before reconnecting the appliance.
The electronics have overheated and have switched off the affected cooking zone. The electronics have overheated and all the cooking zones have been switched off.	Wait until the electronics have cooled down sufficiently. When the fault code on the display goes out, you can resume cooking.
There is hot cookware near the control panel. To protect the electronics, the cooking zone has been switched off.	Remove the cookware that is causing the problem. Wait a few seconds. When the fault code on the display disappears, you can resume cooking.
The cooking zone has overheated and has been switched off to protect the work surface.	Wait until the electronics have cooled down sufficiently before switching the cooking zone on again.
The transfer settings function cannot be activated.	The "active" item of cookware has been removed from its position and a pot or pan of a different size has been put in its place. Test with the same item of cookware. Acknowledge the fault code by touching any of the buttons. You can cook as usual without using the transfer settings function. Inform the technical after-sales service.
The hob has been operating continuously for an extended period.	The automatic safety cut-out function has been activated. See section

Disconnect the appliance from the mains power supply and then wait for a few seconds before reconnecting it. If the message appears again, contact our technical after-sales service.

Please quote the fault code when you call the technical after-sales service.

Notes

- The top line of the display lights up red.
- A fault code is displayed with some fault messages (e.g. [E0513])
- If a fault occurs, the appliance does not switch to standby mode.
- For more information, see the section entitled → "Frequently Asked Questions (FAQ)".

Problem	Solution
The cooking sensor has overheated and the cooking zone has been switched off. E8202	Wait until the cooking sensor has cooled down sufficiently before activating the function again.
The cooking sensor has overheated and the adjacent cooking zones have been switched off. E8203	If you are not using the cooking sensor, remove it from the cookware and keep it away from the other cooking zones and sources of heat. Switch the cooking zones back on.
The battery in the cooking sensor is almost flat. E8204	Replace the 3 V CR2032 battery. See section → <i>"Replacing the battery"</i>
The connection to the cooking sensor has been broken. E8205	Switch the function off and then on again.
The cooking sensor is faulty. E8206	Inform the technical after-sales service.
The cooking sensor indicator does not light up and the cooking sensor is not responding.	<p>Replace the 3 V CR2032 battery. See section → <i>"Replacing the battery"</i></p> <p>If this does not solve the problem, press and hold the symbol on the cooking sensor for 8-10 seconds and then reconnect the cooking sensor to the hob. See section → <i>"Connecting the wireless temperature sensor to the control panel"</i></p> <p>If the problem still persists, contact the technical after-sales service.</p>
The sensor indicator flashes twice. The battery in the cooking sensor is almost flat. You may be interrupted the next time you cook by the battery running out.	Replace the 3 V CR2032 battery. See section → <i>"Replacing the battery"</i>
The sensor indicator flashes three times. The connection to the cooking sensor has been broken.	Press and hold the symbol on the cooking sensor for 8-10 seconds and then reconnect the cooking sensor to the hob. See section → <i>"Connecting the wireless temperature sensor to the control panel"</i>
The hob is unable to connect to your home network or the extractor hood. E70 10	<p>Switch the hob off and then on again.</p> <p>If the message appears again, contact our technical after-sales service.</p>
The operating voltage is incorrect/outside of the normal operating range. E9000/E90 10	Contact your electricity supplier.
The hob is not connected correctly U400	Disconnect the hob from the mains. Make sure that it has been connected as shown in the circuit diagram.

Demo mode

If the  symbol appears at the top of the display, this means that demo mode is activated. The appliance will not heat up. Disconnect the appliance from the power supply and then wait for a few seconds before reconnecting it. Then deactivate demo mode in the basic settings menu within the next 3 minutes. See the section entitled → *"Basic settings"*

Customer service

Our after-sales service is there for you if your appliance needs to be repaired. We will always find an appropriate solution, also in order to avoid after-sales personnel having to make unnecessary visits.

Product number (E no.) and production number (FD no.)

Please quote the E number (product number) and the FD number (production number) of your appliance when contacting our after-sales service.

The rating plate bearing these numbers can be found:

- On the appliance certificate.
- On the underside of the hob.

The product number (E no.) can also be found on the glass-ceramic hob. You can check the after-sales service index (KI) and production number (FD no.) by going to the basic settings. Refer to the section entitled → "*Basic settings*" to find out how to do this.

Please note that a visit from an after-sales service engineer is not free of charge in the event that the appliance has been misused, even during the warranty period.

Please find the contact data of all countries in the enclosed customer service list.

To book an engineer visit and product advice

GB 0344 892 8988
Calls charged at local or mobile rate.

IE 01450 2655
0.03 € per minute at peak.
Off peak 0.0088 € per minute.

AU 1300 368 339

NZ 09 477 0492

Trust the expertise of the manufacturer, and rest assured that the repair will be carried out by trained service technicians using original spare parts for your domestic appliance.

Gaggenau Hausgeräte GmbH
Carl-Wery-Straße 34
81739 München
GERMANY
www.gaggenau.com

9001351292 (980604)
en

GAGGENAU

