

**CI 272**

**CI 262**

Hob

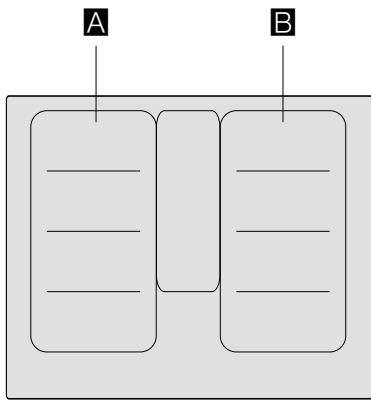

		<b>g*</b>	<b>b*</b>
<b>A / B</b>		2.200 W	3.700 W
		3.300 W	3.700 W
		2.600 W	3.700 W
		3.300 W	3.700 W

\* IEC 60335-2-6

## Table of contents

<b>Intended use</b>	<b>5</b>	<b>Booster function for pans</b>	<b>23</b>
		Recommendations for use	23
<b>Important safety information</b>	<b>6</b>	Activating	24
		Deactivating	24
<b>Causes of damage</b>	<b>8</b>	<b>Keep-warm function</b>	<b>24</b>
Overview	8	Activating	24
		Deactivating	24
<b>Environmental protection</b>	<b>9</b>	<b>Cooking assistance functions</b>	<b>25</b>
Energy-saving advice	9	Cooking assistance function types	25
Environmentally-friendly disposal	9	Suitable cookware	26
		Sensors and special accessories	26
<b>Induction cooking</b>	<b>9</b>	Functions and heat settings	26
Advantages of induction cooking	9	Recommended dishes	30
Cookware	9	Teppan Yaki and Grill for the Flex Zone	36
		<b>Wireless temperature sensor</b>	<b>38</b>
<b>Getting to know your appliance</b>	<b>11</b>	Preparing and maintaining the wireless temperature sensor	38
The control panel	11	Connecting the wireless temperature sensor to the control panel	38
The hotplates	12	Cleaning	39
Residual heat indicator	12	Changing the battery	40
		Declaration of Conformity	40
<b>Twist-Pad with Twist knob</b>	<b>13</b>	<b>Childproof lock</b>	<b>41</b>
Removing the twist knob	13	Activating and deactivating the childproof lock	41
Storing the twist knob	13	<b>Display cleaning protection</b>	<b>41</b>
		<b>Automatic safety cut-out</b>	<b>41</b>
<b>Operating the appliance</b>	<b>13</b>	<b>Basic settings</b>	<b>42</b>
Switching the hob on and off	13	To access the basic settings:	43
Setting a hotplate	14	<b>Home Connect</b>	<b>43</b>
Chef's recommendations	14	Setting up	43
		Home Connect settings	45
<b>Flex function</b>	<b>17</b>	Software update	47
Advice on using cookware	17	Remote diagnostics	47
As two independent hotplates	17	About data protection	48
As a single hotplate	17	Declaration of Conformity	48
		<b>Hood connection</b>	<b>48</b>
<b>FlexPlus cooking zone</b>	<b>18</b>	Setting up	49
Notes regarding cookware	18	Resetting connection	49
Activation	19	Control the hood via the hob	50
Deactivating	19	Hood control settings	50
		<b>Timer functions</b>	<b>21</b>
<b>Transfer function</b>	<b>19</b>	Cooking timer	21
		The short-term timer	22
<b>Professional cooking function</b>	<b>20</b>	Stopwatch function	22
Activation	20	<b>Booster function for pots</b>	<b>23</b>
Deactivating	21	Activating	23
Changing the settings	21	Deactivating	23

<b>Cookware check</b>	<b>51</b>
<b>Power manager</b>	<b>52</b>
<b>Cleaning</b>	<b>52</b>
Hob	52
Hob surround	53
Twist knob	53
<b>Frequently Asked Questions (FAQ)</b>	<b>54</b>
<b>Trouble shooting</b>	<b>56</b>
<b>Customer service</b>	<b>58</b>
Product number (E no.) and production number (FD no.)	58

Additional information on products, accessories, replacement parts and services can be found at [www.gaggenau.com](http://www.gaggenau.com) and in the online shop [www.gaggenau.com/zz/store](http://www.gaggenau.com/zz/store)

## Intended use

Read these instructions carefully. Please keep the instruction and installation manual, as well as the appliance certificate, in a safe place for later use or for subsequent owners.

Check the appliance after removing it from the packaging. If it has suffered any damage in transport, do not connect the appliance, contact the Technical Assistance Service and provide written notification of the damage caused, otherwise you will lose your right to any type of compensation.

Only a licensed professional may connect appliances without plugs. Damage caused by incorrect connection is not covered under warranty.

This appliance must be installed according to the installation instructions included.

This appliance is intended for private domestic use and the household environment only. The appliance must only be used for the preparation of food and beverages. The cooking process must be supervised. A short cooking process must be supervised without interruption. Only use the appliance in enclosed spaces.

This appliance is intended for use up to a maximum height of 4000 metres above sea level.

Do not use covers. These can cause accidents, for example due to overheating, catching fire or materials shattering.

Only use safety devices or child protection grilles approved by ourselves. Unsuitable safety devices or child protection grilles may result in accidents.

This appliance is not intended for operation with an external clock timer or a remote control.

This appliance may be used by children over the age of 8 years old and by persons with reduced physical, sensory or mental capabilities or by persons with a lack of experience or knowledge if they are supervised or are instructed by a person responsible for their safety how to use the appliance safely and have understood the associated hazards.

Children must not play with, on, or around the appliance. Children must not clean the appliance or carry out general maintenance unless they are at least 15 years old and are being supervised.

Keep children below the age of 8 years old at a safe distance from the appliance and power cable.

If you are using the cooking sensor functions, ensure that the cooking zone that is set corresponds to the cooking zone on which the cookware with the temperature sensor are located.

If you wear an active implantable medical device (e.g. a pacemaker or defibrillator), check with your doctor that it complies with Council Directive 90/385/EEC of 20th June 1990, DIN EN 45502-2-1 and DIN EN 45502-2-2, and that it has been chosen, implanted and programmed in accordance with VDE-AR-E 2750-10. If these conditions are satisfied, and if, in addition, non-metal cooking utensils and cookware with non-metal handles are used, it is safe to use this induction hob as intended.

## **⚠ Important safety information**

### **⚠ Warning – Danger of suffocation!**

Packaging material is dangerous to children. Never allow children to play with packaging material.

### **⚠ Warning – Risk of fire!**

- Hot oil and fat can ignite very quickly. Never leave hot fat or oil unattended. Never use water to put out burning oil or fat. Switch off the hotplate. Extinguish flames carefully using a lid, fire blanket or something similar.
- The hotplates become very hot. Never place combustible items on the hob. Never place objects on the hob.
- The appliance gets hot. Do not keep combustible objects or aerosol cans in drawers directly underneath the hob.
- The hob switches off automatically and can no longer be operated. It may switch on unintentionally at a later point. Switch off the circuit breaker in the fuse box. Contact the after-sales service.
- Do not use hob covers here. They can cause accidents, for example due to overheating, catching fire or materials shattering.

### **⚠ Warning – Risk of burns!**

- The hotplates and surrounding area (particularly the hob surround, if fitted) become very hot. Never touch the hot surfaces. Keep children at a safe distance.
- The hotplate heats up but the display does not work. Switch off the circuit breaker in the fuse box. Contact the after-sales service.
- Metal objects on the hob quickly become very hot. Never place metal objects (such as knives, forks, spoons and lids) on the hob.
- After each use, always turn off the hob at the main switch. Do not wait until the hob turns off automatically after the pan is removed.

### **⚠ Warning – Risk of electric shock!**

- Incorrect repairs are dangerous. Repairs may only be carried out and damaged power cables replaced by one of our trained after-sales technicians. If the appliance is defective, unplug the appliance from the mains or switch off the circuit breaker in the fuse box. Contact the after-sales service.
- Do not use any high-pressure cleaners or steam cleaners, which can result in an electric shock.
- A defective appliance may cause electric shock. Never switch on a defective appliance. Unplug the appliance from the mains or switch off the circuit breaker in the fuse box. Contact the after-sales service.
- Cracks or fractures in the glass ceramic may cause electric shocks. Switch off the circuit breaker in the fuse box. Contact the after-sales service.

**⚠ Warning – Hazard due to magnetism!**

- The removable control element is magnetic. Magnets may affect electronic implants, e.g. heart pacemakers or insulin pumps. Thus, for persons with electronic implants: avoid carrying the control element in clothing pockets; keep a minimum distance of 10 cm to heart pacemaker or device.
- The wireless temperature sensor is magnetic. The magnetic elements in it may damage electronic implants, e.g. pacemakers or insulin pumps. People fitted with electronic implants should therefore not carry the temperature sensor in their pockets and always keep it at least 10 cm away from their pacemaker or similar medical device.

**⚠ Warning – Risk of fault!**

A fan is located on the underside of this hob. If a drawer is located on the underside of the hob, do not store any small or sharp objects, paper or tea towels in it. These may be sucked in and damage the fan or impair the cooling.

There must be a clearance of at least 2 cm between the contents of the drawer and the fan entry point.

**⚠ Warning – Risk of injury!**

- The wireless cooking sensor is equipped with a battery, which may become damaged if it is exposed to high temperatures. Remove the sensor from the cookware and store it away from any heat sources.
- The temperature sensor may be very hot when removing it from the saucepan. Wear oven gloves or use a tea towel to remove it.
- When cooking in a bain marie, the hob and cooking container could shatter due to overheating. The cooking container in the bain marie must not directly touch the bottom of the water-filled pot. Only use heat-resistant cookware.
- Saucepans may suddenly jump due to liquid between the pan base and the hotplate. Always keep the hotplate and saucepan bases dry.

---

## Causes of damage

---

**Caution!**

- Rough pan bases may scratch the hob.
- Avoid leaving empty pots and pans on the hotplate. Doing so may cause damage.
- Do not place hot pans on the control panel, the indicator area, or the hob frame. Doing so may cause damage.
- Hard or pointed objects dropped on the hob may damage it.
- Aluminium foil and plastic containers will melt if placed on the hotplate while it is hot. The use of laminated sheeting is not recommended on the hob.

**Overview**

The table below lists the commonest kinds of damage:

<b>Damage</b>	<b>Cause</b>	<b>Remedy</b>
Stains	Food boiling over	Remove any food that has boiled over immediately with a glass scraper
	Unsuitable cleaning agents	Only use cleaning agents that are suitable for this type of hob
Scratches	Salt, sugar and sand	Do not use the hob as a work surface or storage space
	Rough pan bases can scratch the hob	Inspect the cookware
Discolouration	Unsuitable cleaning agents	Only use cleaning agents that are suitable for this type of hob
	Wear caused by cookware	Lift pots and pans when moving them.
Blistering	Sugar, food with a high sugar content	Remove any food that has boiled over immediately with a glass scraper



## Environmental protection

In this section, you can find information about saving energy and disposing of the appliance.

### Energy-saving advice

- Always use the correct lid for each pan. Cooking without a lid uses a lot more energy. Use a glass lid to provide visibility and avoid having to lift the lid.
- Use pans with flat bases. Bases that are not flat use a lot more energy.
- The diameter of the pan base must match the size of the hotplate. Please note: pan manufacturers usually provide the diameter for the top of the pan, which is usually larger than the diameter of the pan base.
- Use a small pan for small amounts of food. A large pan which is not full uses a lot of energy.
- Use little water when cooking. This saves energy and preserves all the vitamins and minerals in vegetables.
- Select the lowest power level to maintain cooking. If the power level is too high, energy is wasted.

### Environmentally-friendly disposal

Dispose of packaging in an environmentally-friendly manner.



This appliance is labelled in accordance with European Directive 2012/19/EU concerning used electrical and electronic appliances (waste electrical and electronic equipment - WEEE). The guideline determines the framework for the return and recycling of used appliances as applicable throughout the EU.

The wireless temperature sensor is battery-powered. Dispose of used batteries in an environmentally responsible manner.

## Induction cooking

### Advantages of induction cooking

Induction cooking is very different from traditional cooking methods, as heat builds up directly in the item of cookware. This offers numerous advantages:

- Saves time when boiling and frying.
- Saves energy.
- Easier to care for and clean. Spilled food does not burn on as quickly.
- Heat control and safety – the hob increases or decreases the heat supply as soon as the user changes the setting. The induction hotplate stops the heat supply as soon as the cookware is removed from the hotplate, without having to switch it off first.

### Cookware

Only use ferromagnetic cookware for induction cooking, such as:

- Cookware made from enamelled steel
- Cookware made from cast iron
- Special induction-compatible cookware made from stainless steel.

To check whether your cookware is suitable for induction cooking, refer to the section on → "Cookware check".

To achieve a good cooking result, the ferromagnetic area on the base of the pan should match the size of the hotplate. If a hotplate does not detect the cookware, try placing the cookware on another hotplate with a smaller diameter.

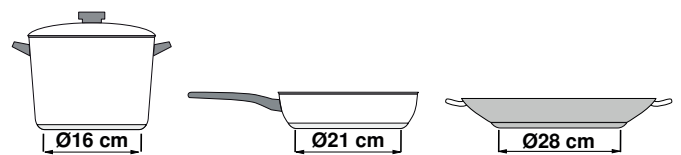

If the only hotplate being used is the flexible cooking zone, larger cookware that is particularly suited to this zone can be used. You can read more information on the positioning of the cookware here → "Flex function"



Some induction cookware does not have a fully ferromagnetic base:

- If the base of the cookware is only partially ferromagnetic, only the area that is ferromagnetic will heat up. This may mean that heat will not be distributed evenly. The non-ferromagnetic area may not heat up to a sufficient temperature for cooking.

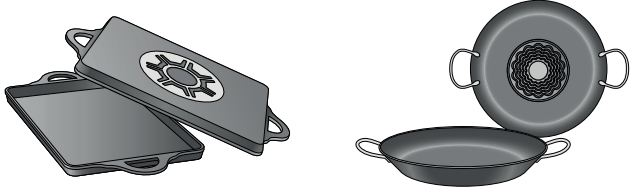

- The ferromagnetic area will also be reduced if the material from which the base of the cookware is made contains aluminium, for example. This may mean that the cookware will not become sufficiently hot or even that it will not be detected.



### Unsuitable pans

Never use diffuser hobs or pans made from:

- common thin steel
- glass
- earthenware
- copper
- aluminium

### Properties of the base of the cookware

The material(s) from which the base of the cookware is made can affect the cooking result. Using pots and pans made from materials that distribute heat evenly through them, such as stainless-steel pans with a three-layer base, saves time and energy.

Use cookware with a flat base; if the base of the cookware is uneven, this may impair the heat supply.

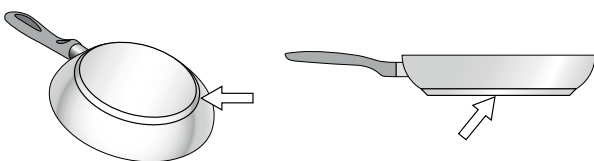

### Absence of pan or unsuitable size

If no pan is placed on the selected hotplate, or if it is made of unsuitable material or is not the correct size, the power level displayed on the hotplate indicator will flash. Place a suitable pan on the hotplate to stop the flashing. If this takes more than 90 seconds, the hotplate will switch off automatically.

### Empty pans or those with a thin base

Do not heat empty pans, nor use pans with a thin base. The hob is equipped with an internal safety system. However, an empty pan may heat up so quickly that the "automatic switch off" function may not have time to react and the pan may reach very high temperatures. The base of the pan could melt and damage the glass on the hob. In this case, do not touch the pan and switch the hotplate off. If it fails to work after it has cooled down, please contact the Technical Assistance Service.

### Pan detection

Each hotplate has a lower limit for pan detection. This depends on the diameter of the ferromagnetic area of the cookware and the material from which its base is made. For this reason, you should always use the hotplate that best matches the diameter of the base of the pan.

## Getting to know your appliance

You can find information on the dimensions and power of the hotplates in → *Page 2*

**Note:** : Depending on the appliance model, individual details and colours may differ.

### The control panel

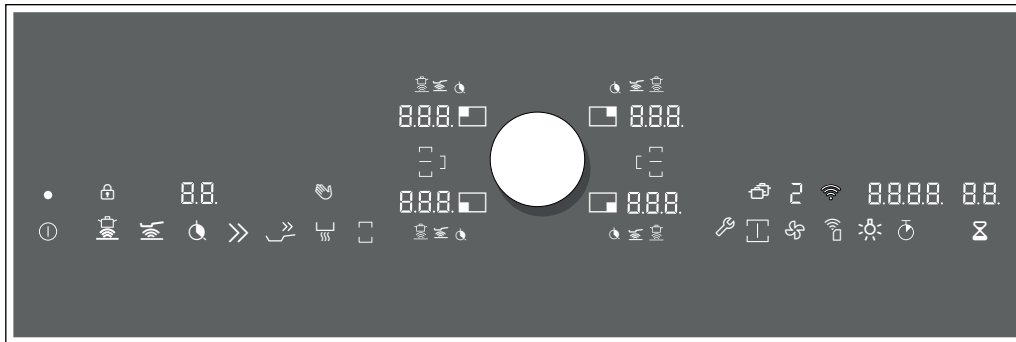

#### Selection sensors

	Main switch
	Cooking sensor
	Frying sensor technology for pans
	Timer function
	Booster function for pots
	Booster function for pans
	Keep-warm function
	Flex function
	Basic settings
	Professional cooking function
	Ventilation control
	Home Connect – confirm setting
	Extractor hood lighting
	Stopwatch
	Timer

#### Indicators/symbols

	Operating status
	Cooking zones
	Power levels
	Cooking sensor
	Frying sensor technology for pans
	Cooking timer
	Booster function for pots
	Booster function for pans
	Keep-warm function
	Residual heat
	WLAN
	Fan settings
	Timer
	Stopwatch
	Display cleaning protection
	Childproof lock
	Flex function activated
	Flex function deactivated
	FlexPlus cooking zone
	Transfer function

## Touch keys



When the hob heats up, the symbols for the touch keys available at this time light up.

Touching a symbol activates the associated function. A confirmation signal sounds.

### Notes

- The corresponding symbols for the touch keys light up depending on whether they are available. The indicators for the available functions light up in white. Once a function is selected, its indicator lights up in orange.
- Always keep the control panel clean and dry. Moisture can prevent it from working properly.
- Do not pull cookware close to the displays and sensors. The electronics could overheat.

## The hotplates

Hotplates		
	Simple hotplate	Use cookware that is a suitable size.
	Flexible cooking zone	See section → " <i>Flex function</i> "
	FlexPlus cooking zone	The FlexPlus cooking zone always switches on in conjunction with the right- or left-hand flexible cooking zone. See section → " <i>FlexPlus cooking zone</i> "
Only use cookware that is suitable for induction cooking; see section → " <i>Induction cooking</i> "		

## Residual heat indicator

The hob has a residual heat indicator for each hotplate. This indicates that a hotplate is still hot. Do not touch a hotplate while the residual heat indicator is lit up.

The following indicators are shown depending on the amount of residual heat:

- Display **H**: High temperature
- Display **h**: Low temperature

If you remove the cookware from the hotplate during cooking, the residual heat indicator and the selected heat setting will flash alternately.

When the hotplate is switched off, the residual heat indicator will light up. Even after the hob has been switched off, the residual heat indicator will stay lit for as long as the hotplate is still warm.

## Twist-Pad with Twist knob

The twistpad is the area in which you can use the twist knob to select the hotplates and heat settings. The twist knob automatically centres itself in the twistpad area.

The twist knob is magnetic and is placed on top of the twistpad. To activate a hotplate, touch the twist knob at the level for the required hotplate. Turning the twist knob selects the heat setting.

Position the twist knob on the twist pad so that it is in the centre of the indicators which delimit the twist pad area.

**Note:** Even if the twist knob is not entirely central, this will not affect how the twist knob works.

## Removing the twist knob

Removing the twist knob activates the wipe protection function.

The twist knob can be removed during cooking. The wipe protection function is activated for 10 minutes. If the twist knob is not returned to its position before this time elapses, the hob will switch off.

### Warning – Risk of fire!

If a metallic object is placed in the twist pad area during these 10 minutes, the hob may continue to heat up. For this reason, always switch off the hob using the main switch.

## Storing the twist knob

A strong magnet is located inside of the twist knob. Keep the twist knob away from magnetic data carriers such as credit cards and cards with magnetic strips. Otherwise, these data carriers may be damaged beyond repair.

The magnet may also cause faults on televisions and screens.



**Note:** The twist knob is magnetic. Metal particles stuck to the bottom may scratch the surface of the hob. Always clean the twist knob thoroughly.



## Operating the appliance

This chapter explains how to set a hotplate. The table shows heat settings and cooking times for various meals.

## Switching the hob on and off

Use the main switch to switch the hob on and off.

When you first switch on the appliance, you will be prompted to set up your home network. The  symbol will be lit dimly for a few seconds on the display panel. To begin setting up the connection, touch the  sensor and proceed in accordance with the information given in the section entitled → "Home Connect" on page 43. To exit initial set-up, touch any sensor.

**To switch on:** Position the twist knob on the control panel. Touch the  symbol. The symbols for the cooking zones and the functions available at this time light up.  lights up next to the cooking zones. The hob is ready for use.

**To switch off:** Touch the  symbol until the display goes out. All the hotplates are switched off. The residual heat indicator remains lit until the cooking zones have cooled down sufficiently.

### Notes

- If the appliance has not been connected to your home network or the connection has been broken, network connection initial set-up will be activated whenever you switch on the hob.
- The hob will automatically switch itself off if all hotplates have been switched off for more than 20 seconds.
- The selected settings are stored for 5 seconds after the hob has been switched off. If the hob is switched back on during this time, the heat settings that were previously set will flash. To apply these settings, tap on the twist knob within the next 5 seconds. If you do not tap the twist knob or you touch a different sensor button, all the previous settings will be deleted.

## Setting a hotplate

Set the required hotplate using the twist knob.

Heat setting 1 = lowest setting.

Heat setting 9 = highest setting.

Every heat setting has an intermediate setting. This is shown in the hotplate display as **.5**.

### Notes

- To protect the fragile parts of your appliance from overheating and electrical overloading, the hob may temporarily reduce the power.
- In order to prevent the appliance from producing excess noise, the hob may temporarily reduce the power.

## Selecting a hotplate and heat setting

The hob must be switched on.

- 1 Select the hotplate. To do this, touch the twist knob in the appropriate area for the required hotplate.
- 2 Turn the twist knob until the required heat setting appears in the heat setting display.

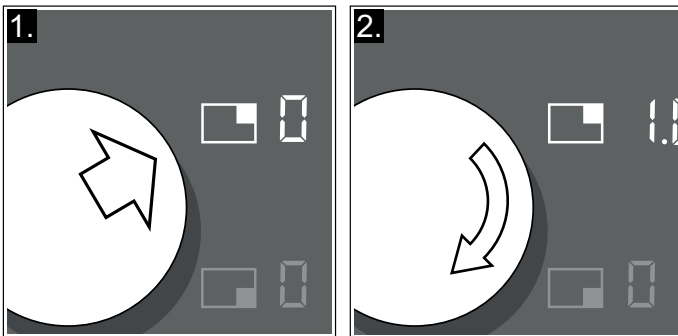

The heat setting is set.

### Notes

- When placing an item of cookware on the flexible cooking zone, it must be positioned correctly according to size; see section → "*Flex function*". The cookware is detected and the hotplate is selected automatically. You can change the settings.
- If the indicators flash after you have changed the settings, check whether the cookware is suitable for induction cooking. See section → "*Cookware check*"

## Changing the heat setting

Select the hotplate and change the heat setting using the twist knob.

## Switching off the hotplate

Select the hotplate and turn the twist knob until  appears. The hotplate switches itself off and the residual heat indicator lights up.

### Notes

- If there is no cookware on the induction hotplate, the heat setting display flashes. After a while, the hotplate will switch itself off.
- If there is cookware on the hotplate before switching the hob on, this is detected at most 20 seconds after touching the main switch and the hotplate is selected automatically. Set the heat setting within the next 10 seconds. Otherwise the hotplate will switch itself off again after 20 seconds.  
Even if there are several pots and pans on the hob when it is switched on, only one item of cookware is detected.

## Chef's recommendations

### Recommendations

- When heating up puree, cream soups and thick sauces, stir occasionally.
- Set heat setting 8 to 9 for preheating.
- When cooking with the lid on, turn the heat setting down as soon as steam escapes between the lid and the cookware. Steam does not need to escape for a good cooking result.
- After cooking, keep the lid on the cookware until you serve the food.
- To cook with the pressure cooker, observe the manufacturer's instructions.
- Do not cook food for too long, otherwise the nutrients will be lost. The kitchen clock can be used to set the optimum cooking time.
- For a more healthy cooking result, smoking oil should be avoided.
- To brown food, fry small portions in succession.
- Cookware may reach high temperatures while the food is cooking. We recommend that you use oven gloves.
- You can find recommendations for energy-efficient cooking in section → "*Environmental protection*"

## Cooking table

The table shows which heat setting is suitable for each type of food. The cooking time may vary depending on the type, weight, thickness and quality of the food.

	Power level	Cooking time (mins)
<b>Melting</b>		
Chocolate, coating	1 - 1.5	-
Butter, honey, gelatine	1 - 2	-
<b>Heating and keeping warm</b>		
Stew, e.g. lentil stew	1.5 - 2	-
Milk*	1.5 - 2.5	-
Scalded sausages*	3 - 4	-
<b>Defrosting and heating</b>		
Spinach, frozen	3 - 4	15 - 25
Goulash, frozen	3 - 4	35 - 55
<b>Poaching, simmering</b>		
Potato dumplings*	4.5 - 5.5	20 - 30
Fish*	4 - 5	10 - 15
White sauces, e.g. Béchamel sauce	1 - 2	3 - 6
Whisked sauces, e.g. Béarnaise sauce, Hollandaise sauce	3 - 4	8 - 12
<b>Boiling, steaming, stewing</b>		
Rice (with double the volume of water)	2.5 - 3.5	15 - 30
Rice pudding***	2 - 3	30 - 40
Unpeeled boiled potatoes	4.5 - 5.5	25 - 35
Boiled potatoes	4.5 - 5.5	15 - 30
Pasta*	6 - 7	6 - 10
Stew	3.5 - 4.5	120 - 180
Soups	3.5 - 4.5	15 - 60
Vegetables	2.5 - 3.5	10 - 20
Vegetables, frozen	3.5 - 4.5	7 - 20
Stew in a pressure cooker	4.5 - 5.5	-
<b>Braising</b>		
Rolled roasting joint	4 - 5	50 - 65
Pot roast	4 - 5	60 - 100
Goulash***	3 - 4	50 - 60

\* Without a lid

\*\* Turn several times

\*\*\* Preheat to heat setting 8–8.5

	Power level	Cooking time (mins)
<b>Roasting/frying with little oil*</b>		
Escalope, plain or breaded	6 - 7	6 - 10
Escalope, frozen	6 - 7	6 - 12
Chops, plain or breaded**	6 - 7	8 - 12
Steak (3 cm thick)	7 - 8	8 - 12
Poultry breast (2 cm thick)**	5 - 6	10 - 20
Poultry breast, frozen**	5 - 6	10 - 30
Rissoles (3 cm thick)**	4.5 - 5.5	20 - 30
Hamburgers (2 cm thick)**	6 - 7	10 - 20
Fish and fish fillet, plain	5 - 6	8 - 20
Fish and fish fillet, breaded	6 - 7	8 - 20
Fish, breaded and frozen, e.g. fish fingers	6 - 7	8 - 15
Prawns and scampi	7 - 8	4 - 10
Sautéing fresh vegetables and mushrooms	7 - 8	10 - 20
Stir-fry, vegetables, meat cut in strips Asian-style	7 - 8	15 - 20
Stir fries, frozen	6 - 7	6 - 10
Pancakes (cooked one after the other)	6.5 - 7.5	-
Omelette (cooked one after the other)	3.5 - 4.5	3 - 10
Fried egg	5 - 6	3 - 6
<b>Deep-fat frying* (150–200 g per portion in 1–2 l oil, deep-fat fried in portions)</b>		
Frozen products, e.g. chips, chicken nuggets	8 - 9	-
Croquettes, frozen	7 - 8	-
Meat, e.g. chicken portions	6 - 7	-
Fish, breaded or battered	6 - 7	-
Vegetables, mushrooms, breaded, beer-battered or tempura	6 - 7	-
Small baked items, e.g. doughnuts, beer-battered fruit	4 - 5	-

\* Without a lid

\*\* Turn several times

\*\*\* Preheat to heat setting 8–8.5



## Flex function

The flexible cooking zone can be used as a single hotplate or as two independent hotplates, as required.

It consists of four inductors that work independently of each other. If the flex function is in use, only the area that is covered by cookware is activated.

## Advice on using cookware

To ensure that the cookware is detected and heat is distributed evenly, correctly centre the cookware:

### As a single hotplate

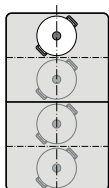

Diameter smaller than or equal to 13 cm  
Place the cookware on one of the four positions that can be seen in the illustration.

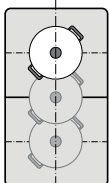

Diameter greater than 13 cm  
Place the cookware on one of the three positions that can be seen in the illustration.

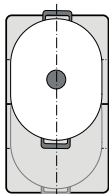

If the cookware takes up more than one hotplate, place it starting on the upper or lower edge of the flexible cooking zone.

### As two independent hotplates

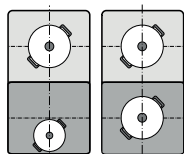

The front and rear hotplates each have two inductors and can be used independently of each other. Select the required heat setting for each of the hotplates. Use only one item of cookware on each hotplate.

### Recommendations

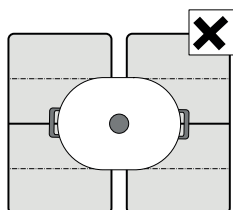

If the hob has more than one flexible cooking zone, place the cookware on top so that it covers only one of the flexible cooking zones.

Otherwise, the hotplates will not be activated as intended and the cooking result will not be satisfactory.

## As two independent hotplates

The flexible cooking zone is used like two independent hotplates.



### Activating

See the section entitled → "Operating the appliance"

## As a single hotplate

Using the entire cooking zone by connecting both hotplates.

### Linking the two hotplates

- 1 Set down the cookware. Select one of the two hotplates in the flexible cooking zone and set the heat setting.
- 2 Touch the  symbol. The  indicator lights up next to the cooking zone display.

The flexible cooking zone has now been activated. The heat setting appears in the two displays for the flexible cooking zone.

### Notes

- If both hotplates are set to different heat settings before being linked, switch both hotplates to 0 on activation.
- If there is a cooking timer programmed for one hotplate, this will also be assigned to the second hotplate when the two are linked.

### Changing the heat setting

Select one of the two hotplates assigned to the flexible cooking zone and set the heat setting using the twist knob.



### Adding new cookware

- 1 Set down additional cookware in the appropriate position according to size.  
If correctly positioned, cookware is detected and the hotplate is selected automatically; the corresponding part of the display  flashes.
- 2 Use the twist knob to confirm the setting within 90 seconds. The indicators stop flashing and the cookware is heated up.

**Note:** If the indicators continue to flash, check whether the cookware is suitable for induction cooking → "Cookware check"

**Note:** If the cookware is moved to the hotplate being used or lifted up, the hotplate begins an automatic search and the heat setting selected previously is retained.

### Disconnecting the two cooking zones

- 1 Select one of the two cooking zones assigned to the FlexZone.
- 2 Touch the  symbol.
- 3 The  symbol appears in the cooking zone display.

The Flex function has been deactivated. The two cooking zones now operate independently of one another.

**Note:** If the hob is switched off, and then switched back on again later, the flexible cooking zone is reset to function as two independent hotplates.

---

## FlexPlus cooking zone

---

The hob has a FlexPlus cooking zone which is located between the two flexible cooking zones and which switches on in conjunction with the right- or left-hand flexible cooking zone. This means that larger cooking vessels can be used and better cooking results can be achieved.

The FlexPlus cooking zone always switches on in conjunction with one of the two flexible cooking zones. It is not possible to activate these cooking zones independently.

### Notes regarding cookware

The cookware should be positioned centrally for good thermal detection and distribution.

The cookware should cover the side hotplate and the FlexPlus cooking zone.

Depending on the size of the cookware, the flexible cooking zone can be activated as two independent hotplates or as one hotplate:

---

#### Set down the cookware

---

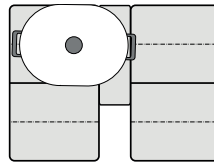

Oblong cookware  
Activate the flexible cooking zone as two independent hotplates or as one hotplate.

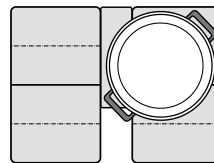

Large round cookware  
Activate the flexible cooking zone as a single hotplate.

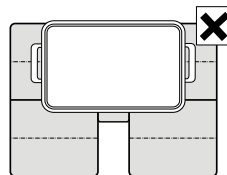

The vessel must not cover the two side cooking zones and the FlexPlus cooking zone at the same time.

---

## Activation

- 1 Set down the cookware on the hotplate and make sure that it also covers the FlexPlus cooking zone.
- 2 Select the hotplate and the required heat setting. The hotplate and FlexPlus cooking zone indicators light up.

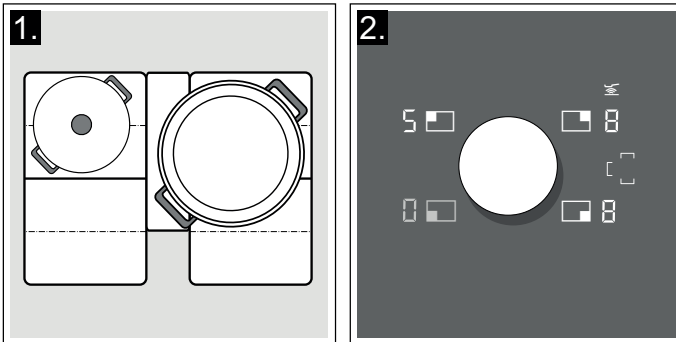

The flexible cooking zone is activated.

**Note:** If the two cooking zones next to the FlexPlus cooking zone are covered by cookware, the FlexPlus cooking zone indicator may flash.

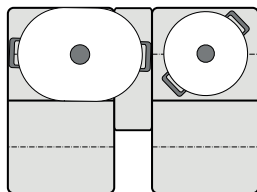

To link the FlexPlus cooking zone to the corresponding cooking zone, lift the cookware and set it back down on the cooking zone before selecting a heat setting.

## Deactivating

Remove the cookware from the hotplate. The displays go out.

This deactivates the FlexPlus cooking zone.

## Transfer function

You can use this function to transfer the power level, set cooking time and selected cooking sensor function from one cooking zone to another.

To transfer the settings, move the cookware from the cooking zone that is switched on to another cooking zone.

This function can also be used on the flexible cooking zones.

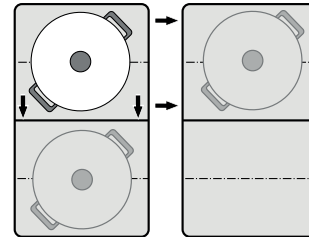

**Note:** You can find additional information on the correct positioning of the cookware in the section on → "Flex function"

- 1 Remove any cookware from the hob. The hotplate indicator will start flashing. The hotplate will not heat up.

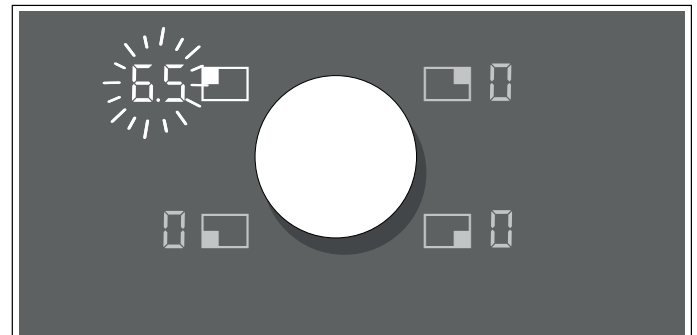

- 2 Set down the cookware on a flexible hotplate within the next 90 seconds. The new hotplate is detected and the  symbol lights up. The heat setting that has been applied will flash in the hotplate display.

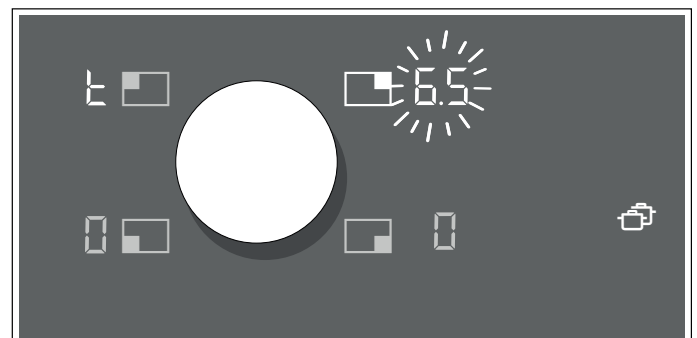

- 3 Select the new hotplate within 90 seconds using the twist knob. The settings have been transferred.

## Notes

- Move the cookware to a cooking zone that is not switched on, that you have not yet preset or on which no other cookware has been placed previously.
- If the Flex function is activated by moving an item of cookware across the flexible cooking zone, the settings are automatically applied.
- The booster functions can only be moved from left to right or from right to left when none of the cooking zones are active.
- If a new item of cookware is set down on a different cooking zone before the settings have been confirmed, this function will be ready for both cooking vessels. Confirm the required cooking zone.
- If you move more than one item of cookware, the function is only ready to use for the item of cookware that was last moved.
- When you place the cookware back in this position, the same settings is used.

## Professional cooking function

You can use the professional chef function to display the preset heat settings for each hotplate. Set down a suitable item of cookware within 9.5 minutes to apply the default value.

### Activation

- 1 Switch on the hob.
- 2 Touch the  symbol.  
The preset power levels light up in the cooking zone displays.

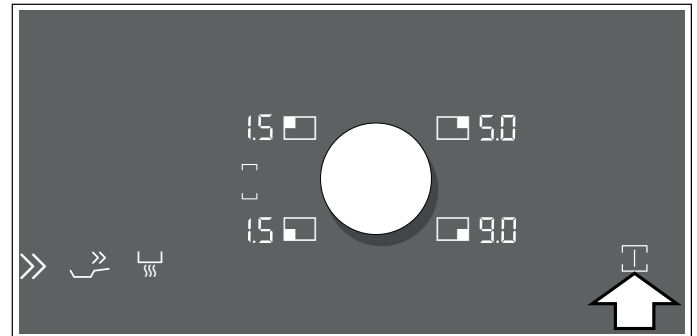





- 3 Place a suitable cookware within eight minutes. Once the cookware has been detected, the corresponding cooking zone is selected. You can adjust the power level using the twist knob. The power level indicators for the unoccupied cooking zones start flashing if the adjustment time has elapsed.
- 4 Touch the  symbol again within 90 seconds to extend the professional cooking function. If the symbol is not touched, the unused cooking zones are switched off.



### Notes

- The keep-warm function can also be set in professional cooking function.
- If you place unsuitable cookware (e.g. aluminium cookware), the display for the power levels flashes until the cookware is removed again. To check whether your cookware is suitable for induction cooking, refer to the section entitled → "Cookware check"

## Deactivating

**To end the function immediately:** Touch the  symbol. Switch all hotplates to heat setting . The  symbol lights up white.

**Function ends automatically:** If no suitable cookware is set down after 8 minutes have elapsed, the  symbol and the corresponding hotplate displays start flashing for 90 seconds. Touch the  symbol twice to switch off the function.

If you do not touch the  symbol, the professional cooking function switches off automatically after 90 seconds. The  symbol lights up white and unoccupied hotplates switch to heat setting . Hotplates that are in use retain the original heat setting.

## Changing the settings

You can change the default settings in the "Basic settings" menu. See the section entitled → "Basic settings"

## Timer functions

Your hob has three timer functions:



- Cooking timer
- Timer
- Stopwatch function

### Cooking timer

The hotplate automatically switches off after the time that is set has elapsed.

You can set a time of up to 99 minutes. The time elapses in the timer display in minutes and the final half a minute is displayed in seconds.

#### Setting procedure:

- 1 Select the hotplate and the required heat setting.
- 2 Touch the  symbol. The  display for the hotplate lights up.  lights up on the timer display.

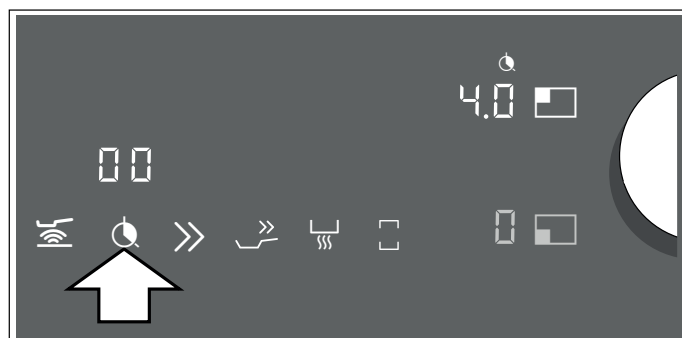

- 3 Use the twist knob to select the required cooking time.

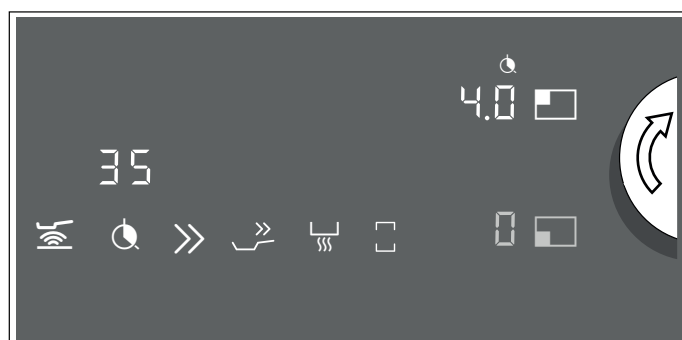

The cooking time begins to elapse.

**Note:** If the flexible cooking zone is selected as the only hotplate, the set time for the entire cooking zone is the same.

### Frying sensor technology for pans/cooking sensor



If you set a cooking time for a cooking zone with activated frying sensor technology or activated cooking sensor, the cooking time begins to count down immediately and not just once the selected temperature level has been reached.

### Changing or deleting the time

Select the hotplate and then touch the  symbol.

Change the cooking time using the twist knob or set to  to delete it.

### When the time has elapsed

The hotplate switches off. A signal sounds,  appears in the hotplate display and  flashes in the timer display. Touch any symbol or press the twist knob; the displays go out and the audible signal ceases.

### Notes



- If a cooking time has been programmed for several hotplates, the cooking time that ends first will appear in the timer display. The  indicator for the hotplate lights up orange.
- Select the relevant hotplate to call up the remaining cooking time for a hotplate. The cooking time will appear for 10 seconds.

## The short-term timer

You can use the short-term timer to set a time of up to 99 minutes.



This works independently from the hotplates and from other settings. This function does not automatically switch off a hotplate.

### How to activate the function



- 1 Touch the  symbol;  appears in the timer display.
- 2 Select the required time using the twist knob.
- 3 Touch the  symbol again to confirm the selected time.

The cooking time begins to elapse.

### Changing or deleting the time

Touch the  symbol and use the twist knob to change the time or set it to .

### When the time has elapsed

A signal sounds for three minutes.  flashes in the timer display. Touch the  symbol again: The displays go out and the audible signal ceases.

### Timer plus

If you press and hold the symbol  for a few seconds before the audible signal ceases, the stopwatch is activated.

The display for the stopwatch shows the elapsed time since the end of the set timer time. The time that was previously set flashes in the timer display.

Press and hold the  symbol for a few seconds. This stops the stopwatch, and the indicators go out.



The function has been deactivated.

## Stopwatch function

The stopwatch shows the cooking time that has elapsed so far in minutes and seconds (mm.ss). The maximum duration is 99 minutes and 59 seconds (99.59). If this value is reached, the display starts again at 00.00.

The stopwatch works independently of the hotplates and other settings. This function does not automatically switch off a hotplate.

### Activating

Touch the  symbol.  appears in the stopwatch display.

The time begins to elapse.

### Deactivating

Touching the  symbol stops the stopwatch function. The stopwatch displays remain lit.

If you touch the  symbol again while it is still orange, the time will continue to elapse.

If you touch and hold the  symbol, the displays will go out.

The function is deactivated.

## Booster function for pots

This function allows large volumes of water to be heated up even more quickly than with power setting 9. The saucepan booster function temporarily increases the maximum output of the selected hotplate.

This function can always be activated for a hotplate, provided the other hotplate in the same group is not in use (see illustration).

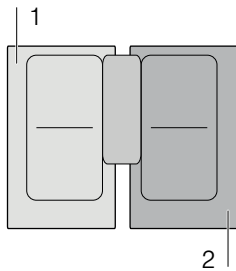

**Note:** The booster function can also be activated on the flexible cooking zone if this is being used as a single hotplate.

### Activating

- 1 Select the hotplate.
- 2 Touch the >> symbol.  
The P indicator lights up.

The function has now been activated.

### Deactivating

- 1 Select the hotplate.
- 2 Touch the >> symbol, turn the twist knob or select a different function.  
The P indicator goes out and the hotplate switches back to the 9 heat setting.

The function is deactivated.

### Notes

- In certain circumstances, this function may switch itself off automatically in order to protect the electronic elements inside the hob.
- If a heat setting was set before activating function, this setting will be automatically applied again after deactivating the function.

## Booster function for pans

This function enables you to heat cookware faster than when using heat setting 9.

After deactivating the function, select the appropriate heat setting for your food.

This function can always be activated for a hotplate, provided the other hotplate in the same group is not in use (see illustration).

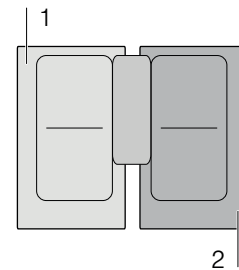



**Note:** The booster function for pans can also be activated on the flexible cooking zone if this is being used as a single hotplate.



### Recommendations for use

- Always use cookware that has not been pre-heated.
- Use pots and pans with a flat base. Do not use cookware with a thin base.
- Never leave empty cookware, oil, butter or lard to heat up unattended.
- Do not place a lid on the cookware.
- Place the cookware on the centre of the hotplate. Ensure that the diameter of the base of the cookware corresponds to the size of the hotplate.
- You can find information on the type, size and positioning of the cookware in section → "Induction cooking"

## Activating

- 1 Select a hotplate.
- 2 Touch the  symbol. The  indicator lights up. The function has now been activated.

## Deactivating

- 1 Select a hotplate.
- 2 Touch the  symbol, turn the twist knob or select a different function. The  display goes out. The heat setting  lights up in the display for the hotplate.

The function is deactivated.

### Notes

- After 30 seconds, this function automatically switches itself off.
- If a power level was set before activating the frying pan function, this is automatically applied again after deactivating the function.



---

## Keep-warm function

---



This function is suitable for melting chocolate or butter and for keeping food warm.

## Activating

- 1 Select the required hotplate.
- 2 Touch the  symbol within the next 10 seconds.  lights up on the display.

The function has now been activated.

## Deactivating

- 1 Select the hotplate.
- 2 Touch the  symbol, turn the twist knob or select a different function. The  indicator goes out. The hotplate switches itself off and the residual heat indicator lights up.

The function is deactivated.



## Cooking assistance functions

The cooking assistance functions are guaranteed to make cooking easier and promise outstanding cooking results. The recommended temperature settings are suitable for any type of cooking.

They enable you to cook without using excessive heat and promise the perfect cooking and frying results.

The sensors measure the temperature of the cookware continuously. This allows the cooking setting to be regulated so that the right temperature is maintained at all times.

You can add your food once the selected temperature has been reached. The temperature is automatically kept constant without you having to change the temperature setting.

This function exists for all cooking zones.

If a wireless cooking sensor is available, the cooking functions are available for all cooking zones.













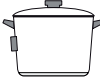

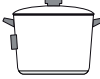

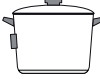

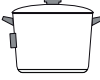
This section contains information about the following:

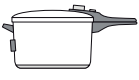
- Cooking assistance function types
- Suitable cookware
- Sensors and optional accessories
- Functions and heat settings
- Recommended dishes

### Cooking assistance function types

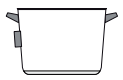
You can use the cooking assistance functions to select the best cooking type for each kind of food.

The table shows the various function settings that are available for the cooking assistants:

Cooking processes	Temperature levels	Cookware	Availability	Activating
<b>Frying sensor technology for pans</b>				
Frying with a little oil	1, 2, 3, 4, 5		All cooking zones	
<b>Cooking sensor</b>				
Keeping warm, heating	70 °C		All cooking zones	
Poaching in milk	85 °C		All cooking zones	
Poaching in water	90 °C		All cooking zones	
Boiling	100 °C		All cooking zones	
Cooking in a pressure cooker	115 °C		All cooking zones	
Deep-fat frying at a low temperature	160 °C		All cooking zones	
Deep-fat frying at a medium temperature	170 °C		All cooking zones	
Deep-fat frying at a high temperature	180 °C		All cooking zones	

\*Preheat with the lid on and deep-fat fry with the lid off.

If the hob does not have a wireless cooking sensor, you can purchase one from specialist retailers, our technical after-sales service or our official website.

## Suitable cookware

Select the cooking zone with the diameter that most closely matches that of the base of the cookware and place the cookware in the centre of this cooking zone.

For the cooking functions, use cookware that is tall enough that, when the required volume of water is added, the water level is higher than the silicone patch for the wireless sensor.

Optimised pans and accessories are available for the frying sensor technology. You can purchase these from specialist retailers or through our technical after-sales service or our official website. Always quote the relevant reference number:

- **GP900001** 15 cm frying pan.
- **GP900002** 19 cm frying pan.
- **GP900003** 21 cm frying pan.
- **GP900004** 28 cm frying pan. Recommended for the FlexPlus cooking zone only.
- **CA051300** teppan yaki. Recommended for the flexible cooking zone only.
- **CA052300** griddle plate. Recommended for the flexible cooking zone only.

These frying pans have a non-stick coating so that you can fry food with a small amount of oil.

### Notes

- The frying sensor for pans is specially optimised for this type and size of frying pan and are ideal for using the Teppan Yaki and grill accessories in the flexible cooking zone.
- If the pans are a different size or are not arranged correctly, the FlexZone's frying sensor technology may not be activated. See section → "*Flex function*".
- Other types of pan may overheat and reach a temperature above or below the selected temperature level. Try the lowest temperature level to begin with and change it if necessary.

Any cookware that can be used with the cooking functions is suitable for the cooking sensor. You can find information on which types of cookware can be used with an induction hob in the section entitled → "*Induction cooking*".

In the Cooking Assistant table, you can find the suitable cookware for each function.

## Sensors and special accessories

The sensors measure the temperature of the cookware continuously. This ensures that the cooking power is controlled with high precision to maintain the correct temperature and achieve optimum cooking results.

Your hob has two different temperature-measuring systems for achieving the best results:

- Temperature sensors that are inside the hob and check the temperature at the base of the cookware. Suitable for frying sensor technology for pans.
- A wireless cooking sensor that transmits information about the temperature of the cookware to the control panel. Suitable for the cooking functions.

The cooking sensor is essential for using the cooking functions.

If your hob does not have a wireless cooking sensor, this can be retroactively purchased from specialist retailers, our technical after-sales service or our official website by quoting the reference number **CA060300**.

You can find more information about the wireless temperature sensor in the section entitled → "*Wireless temperature sensor*".

## Functions and heat settings

### Frying sensor technology for pans

If you are frying food, use this function to maintain the suitable pan temperature.

This function exists for all cooking zones.

### Advantages when frying

- The cooking zone only continues heating for as long as this is necessary to maintain the temperature. This saves energy and prevents the oil or fat from overheating.
- The frying sensor technology reports when the empty pan has reached the optimum temperature for adding oil and then for adding the food.

### Notes

- Do not place a lid on the pan. Otherwise, the function is not activated correctly. Use a splatter guard to prevent fat from spitting out.
- Use suitable oil or fat. If you are using butter, margarine, cold-pressed olive oil or lard, use temperature setting 1 or 2.
- Never leave fat or oil unattended while you are heating it.
- If the cooking zone is a higher temperature than the cookware or vice versa, the cooking sensor is not activated correctly.



- If you are frying with a large amount of oil, always use the following cooking sensor functions: Deep-fat fry a large amount of oil in a pot, set the temperature to 160–180 °C.

### Temperature settings



Temperature setting	Suitable for
1 Very low	Preparing and reducing sauces, stewing vegetables and frying food in extra virgin olive oil, butter or margarine.
2 Low	Frying food in extra virgin olive oil, butter or margarine, e.g. omelettes.
3 Low - medium	Frying fish and thick food such as meatballs and sausages.
4 Medium - high	Frying steaks (medium or well done), frozen breaded products, thin food such as escalopes, strips of meat and vegetables.
5 High	Frying food at high temperatures, e.g. rare steaks (bloody), potato fritters and fried potatoes.

### Setting procedure

Select the appropriate temperature level from the table. Set an empty item of cookware down on the cooking zone.

- 1 Select the hotplate and touch the  symbol. The  symbol lights up in the hotplate display and the temperature setting **A 1** is displayed.



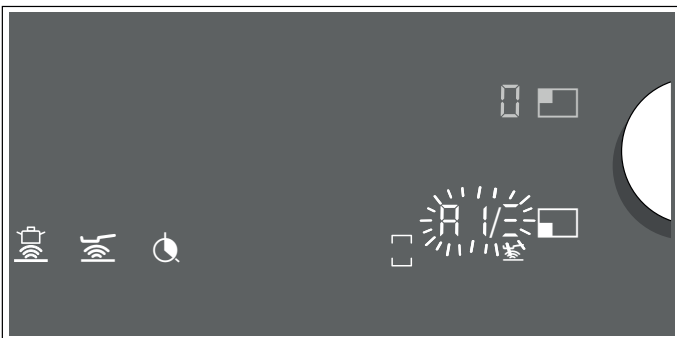

- 2 Within the next 10 seconds, select the required temperature setting using the twist knob.
- 3 The hotplate display shows the progress of the heating process from  to  and flashes alternately with the set heat setting. Once the set frying temperature has been reached, a signal will sound and the heating indicator will go out. The heat setting is displayed again.



- 4 Once the frying temperature has been reached, add the fat and then the food to the pan.

**Note:** Turn the food so that it does not burn.

### Switch off the frying sensor technology for pans

Select the cooking zone and touch the  symbol or use the twist knob to set the temperature level . A signal sounds and the  symbol goes out. The function has been deactivated.

### Cooking sensor

You can use these functions to heat, simmer or cook food, or cook it in a pressure cooker or fry it in a saucepan with sufficient oil at a controlled temperature.

These cooking functions are available for all hotplates.

### Benefits

- The cooking zone only heats up in order to maintain the temperature. This saves energy. Oil or fat do not overheat.
- The temperature is continuously monitored. This prevents the food from spilling over and you do not need to change the temperature level.
- The cooking sensor functions tell you when the water or oil has reached the optimal temperature for adding the food (see the exceptions in the table where the food should be added at the very beginning).

### Notes

- Use pots and pans with a thick, flat base. Do not use pots and pans with a thin or deformed base.
- Fill the pot so that the contents reach high enough to cover the cooking sensor's silicone patch.
- If you are frying using just a little oil, always use the frying sensor technology for pans.
- Position the cookware in such a way that the wireless cooking sensor is pointing towards the outer side of the hob.
- Do not remove the wireless cooking sensor from the pot during cooking.
- After cooking, remove the wireless sensor from the pot. Take care as you do so because the wireless cooking sensor can become very hot.

## Temperature ranges and settings

Cooking sensor	Temperature range	Suitable for
Heating/keeping warm	60-70 °C	E.g. soups, punch
Poaching	80-90 °C	E.g. rice, milk
Boiling	90-100 °C	E.g. pasta, vegetables
Cooking in a pressure cooker	110-120 °C	E.g. chicken, stew.
Frying with a large amount of oil in the pan	170-180 °C	E.g. doughnuts, dumplings

### Tips for cooking with the cooking sensor

- Keeping warm/heating up: Portioned frozen products, e.g. spinach. Place the frozen product in the cookware. Add the volume of water specified by the manufacturer. Place a lid on the cookware and set the temperature to 70 °C. Stir occasionally.
- Poaching: This function is suitable for cooking food at low temperatures and for thickening sauces and stews. Set the temperature to 90 °C .
- Boiling: You can use this function to boil water with the lid on without it boiling over. The temperature control allows for efficient cooking. Set the temperature to 100 °C.
- Cooking in a pressure cooker: Follow the manufacturer's recommendations. After the signal tone sounds, continue cooking for the recommended time. Set the temperature to 115 °C.
- Frying with a large amount of oil in the saucepan: Heat the oil with the lid on. Remove the lid after the signal tone and add the food (insofar as there are no other instructions in the "Recommended dishes" table). Set the temperature to 170 °C.

### Notes

- Always cook with the lid on, except when you use the function for frying with a large amount of oil in the pot, 170 °C.
- If no signal sounds, ensure that there is a lid on the container. For optimum operation of the cooking sensor, we recommend always using a lid, except when you use the function for deep-fat frying with a large amount of oil in the pot.
- Never leave oil unattended when it is being heated. Use oil that is suitable for deep-fat frying. Do not mix different cooking fats and oils – e.g. oil and lard – as such mixtures may foam up when hot.
- If you are not satisfied with the cooking result, e.g. when boiling potatoes, next time use more water. Maintain the recommended temperature setting.

### Setting the boiling point

The point at which water starts to boil depends on the height of your home above sea level. If the water is boiling too vigorously or not vigorously enough, you can set the boiling point. Proceed as follows:





- Select the basic setting **5**; see the section entitled → "Basic settings".
- The basic setting is set to 3 by default. If your home is at an elevation between 200 and 400 m above sea level, there is no need to change the boiling point. If not, choose the correct setting from the following table according to your altitude:

Height	Setting value <b>5</b>
0–100 m	1
100–200 m	2
200–400 m	3*
400–600 m	4
600–800 m	5
800–1000 m	6
1000–1200 m	7
1200–1400 m	8
Over 1400 m	9
* Basic setting	



**Note:** The temperature level 100 °C is sufficient for efficient boiling, even if the water does not boil very quickly. However, you can change the boiling point. If, for example, you want it to boil more quickly, you can select a lower altitude.

## Programming

The hob must be on.

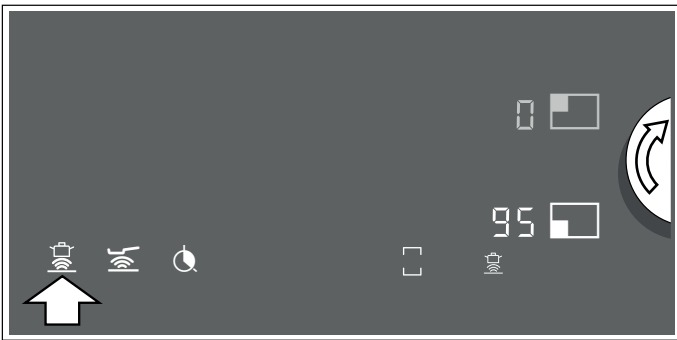
- 1 Attach the temperature sensor to the saucepan; see the section on → "Preparing and maintaining the wireless temperature sensor"
- 2 Place a saucepan filled with sufficient liquid on the required hotplate and always put the lid on.
- 3 Select the required hotplate using the twist knob.  appears in the display for the heat setting.
- 4 Press the  symbol in the control panel. An audible signal sounds. The  symbol lights up in the display for the hotplate.
- 5 Press the symbol  on the wireless cooking sensor. Once the cooking sensor has been detected, the default temperature of 95 °C lights up in the cooking zone display.



- 6 Set the required temperature using the twist knob. The temperature can be changed by increments of 5 °C.
- 7 The hotplate display shows the progress of the heating process from  to  and flashes alternately with the set temperature. Once the set temperature has been reached, an audible signal sounds and the heating indicator goes out. The selected temperature will then be displayed again.

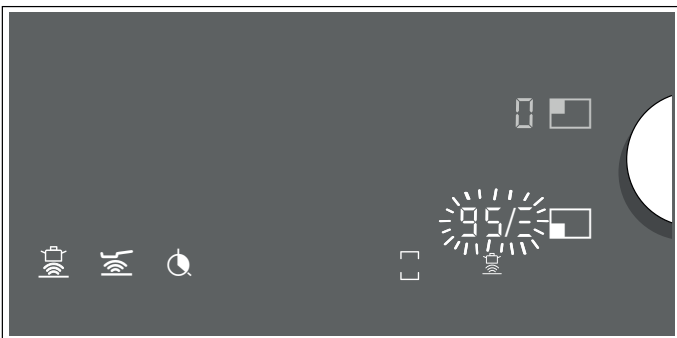

- 8 Once the signal has sounded, take the lid off and add the food. Keep the lid on during cooking.  
**Note:** Do not cover the pan when using the "Frying with a large amount of oil in the saucepan" function.



You can call up the cooking sensor functions using the wireless cooking sensor. Proceed as follows:

- Place the cookware and press the  symbol on the wireless temperature sensor.
- Use the twist knob to select the cooking zone.

When the function is ready, the default temperature of 95 °C is displayed.

### Switching off the cooking sensor function

You can deactivate this function in a number of ways:



- Select the hotplate and touch the  symbol.
- Select the hotplate and set the temperature to  using the twist knob.
- Press the  symbol on the wireless cooking sensor.

























A signal sounds and the  symbol goes out in the hotplate display. The function is deactivated.

## Recommended dishes

The following table shows a selection of dishes and is arranged by food type. The temperature and the cooking time depend on the amount, the condition and the quality of the food.

Cooking assistance functions:

	Frying sensor for pans
	Cooking sensor

Meat	Cooking assistance functions	Temperature level	Total cooking time from signal tone (mins)
<b>Frying with little amount of oil</b>			
Escalope, plain <sup>1</sup>		4	6 - 10
Escalope, breaded <sup>1</sup>		4	6 - 10
Fillet <sup>2</sup>		4	6 - 10
Chops <sup>1</sup>		3	10 - 15
Cordon bleu <sup>1</sup>		4	10 - 15
Viennese schnitzel <sup>1</sup>		4	10 - 15
Steak, rare (3 cm thick) <sup>2</sup>		5	6 - 8
Steak, medium (3 cm thick) <sup>2</sup>		5	8 - 12
Steak, well done (3 cm thick) <sup>1</sup>		4	8 - 12
Poultry breast (2 cm thick) <sup>1</sup>		3	10 - 20
Meat cut into strips <sup>3</sup>		4	7 - 12
Gyros <sup>3</sup>		4	7 - 12
Bacon <sup>1</sup>		2	5 - 8
Minced meat <sup>3</sup>		4	6 - 10
Hamburgers (1.5 cm thick) <sup>1</sup>		3	6 - 15
Meatballs (2 cm thick) <sup>1</sup>		3	10 - 20
Rissoles <sup>1</sup>		3	10 - 20
Boiled sausages <sup>1</sup>		3	8 - 20
Raw sausages <sup>1</sup>		3	8 - 20
<b>Simmering</b>			
Sausages <sup>4</sup>		90 °C	10 - 20
<b>Boiling</b>			
Meatballs <sup>4</sup>		100 °C	20 - 30
Chicken <sup>4</sup>		100 °C	60 - 90
Beef <sup>4</sup>		100 °C	60 - 90
<b>Cooking in a pressure cooker</b>			
Chicken in pressure cooker <sup>5</sup>		115 °C	15 - 25
Beef in pressure cooker <sup>5</sup>		115 °C	15 - 25

<sup>1</sup> Turn frequently.



<sup>2</sup> Add the oil and the food after the signal tone.

<sup>3</sup> Stir frequently.

<sup>4</sup> Heat up and cook with the lid on. Add the food after the signal sounds.

<sup>5</sup> Add the food at the start.

<sup>6</sup> Heat the oil with the lid on. Fry one portion after the other without the lid.

Meat	Cooking assistance functions	Temperature level	Total cooking time from signal tone (mins)
<b>Deep fry with a large amount of oil</b>			
Deep frying chicken portions <sup>6</sup>		170 °C	10 - 15
Deep fry meatballs <sup>6</sup>		170 °C	10 - 15

<sup>1</sup> Turn frequently.





<sup>2</sup> Add the oil and the food after the signal tone.

<sup>3</sup> Stir frequently.

<sup>4</sup> Heat up and cook with the lid on. Add the food after the signal sounds.

<sup>5</sup> Add the food at the start.

<sup>6</sup> Heat the oil with the lid on. Fry one portion after the other without the lid.

Fish	Cooking assistance functions	Temperature level	Total cooking time from signal tone (mins)
<b>Frying with a little amount of oil</b>			
Fish fillet, plain <sup>1</sup>		4	10 - 20
Fish fillet, breaded <sup>1</sup>		3	10 - 20
Prawns <sup>1</sup>		4	4 - 8
Scampi <sup>1</sup>		4	4 - 8
Fried whole fish <sup>1</sup>		3	10 - 20

#### Poaching

Stewed fish <sup>2</sup>		90 °C	15 - 20
--------------------------	---	-------	---------

#### Deep fry with a large amount of oil







Deep-fat frying fish in beer batter <sup>3</sup>		170 °C	10 - 15
--	---	--------	---------

Deep-fat frying breaded fish <sup>3</sup>		170 °C	10 - 15
---	---	--------	---------

<sup>1</sup> Turn frequently.

<sup>2</sup> Heat up and cook with the lid on. Add the food after the signal sounds.

<sup>3</sup> Heat the oil with the lid on. Fry one portion after the other without the lid.

Egg dishes	Cooking assistance functions	Temperature level	Total cooking time from signal tone (mins)
<b>Frying with a little amount of oil</b>			
Fried eggs in butter <sup>1</sup>		2	2 - 6
Fried eggs <sup>2</sup>		4	2 - 6
Scrambled eggs <sup>3</sup>		2	4 - 9
Omelette <sup>4</sup>		2	3 - 6
Crêpes <sup>4</sup>		5	1,5 - 2,5
French toast <sup>4</sup>		3	4 - 8
Shredded raisin pancake <sup>4</sup>		3	10 - 15

#### Boiling

Boiled eggs <sup>5</sup>		100 °C	5 - 10
--------------------------	---	--------	--------

























<sup>1</sup> Add butter and the food after the signal tone sounds.

<sup>2</sup> Add the oil and food to the frying pan after the signal sounds.

<sup>3</sup> Stir frequently.

<sup>4</sup> Time indicated per portion. Fry individually.

<sup>5</sup> Add the food at the start.

Vegetables and pulses	Cooking assistance functions	Temperature level	Total cooking time from signal tone (mins)
<b>Frying with a little amount of oil</b>			
Garlic <sup>1</sup>		2	2 - 10
Onions, glazed <sup>1</sup>		2	2 - 10
Onion rings <sup>1</sup>		3	5 - 10
Courgettes <sup>2</sup>		3	4 - 12
Aubergines <sup>2</sup>		3	4 - 12
Peppers <sup>1</sup>		3	4 - 15
Green asparagus <sup>2</sup>		3	4 - 15
Mushrooms <sup>1</sup>		4	10 - 15
Sautéing vegetables in oil <sup>1</sup>		1	10 - 20
Glazed vegetables <sup>1</sup>		3	6 - 10
<b>Boiling</b>			
Broccoli <sup>3</sup>		100 °C	10 - 20
Cauliflower <sup>3</sup>		100 °C	10 - 20
Brussels sprouts <sup>3</sup>		100 °C	30 - 40
Green beans <sup>3</sup>		100 °C	15 - 30
Chickpeas <sup>4</sup>		100 °C	60 - 90
Peas <sup>3</sup>		100 °C	15 - 20
Lentils <sup>4</sup>		100 °C	45 - 60
<b>Cooking in a pressure cooker</b>			
Vegetables in a pressure cooker <sup>4</sup>		115 °C	3 - 6
Chickpeas in a pressure cooker <sup>4</sup>		115 °C	25 - 35
Beans in a pressure cooker <sup>4</sup>		115 °C	25 - 35
Lentils in a pressure cooker <sup>4</sup>		115 °C	10 - 20
<b>Deep-frying with a large amount of oil</b>			
Deep frying breaded vegetables <sup>5</sup>		170 °C	4 - 8
Deep frying vegetables in beer batter <sup>5</sup>		170 °C	4 - 8
Deep frying breaded mushrooms <sup>5</sup>		170 °C	4 - 8
Deep frying mushrooms in beer batter <sup>5</sup>		170 °C	4 - 8

<sup>1</sup> Stir frequently.









<sup>2</sup> Turn frequently.

<sup>3</sup> Heat up and cook with the lid on. Add the food to the frying pan after the signal sounds.

<sup>4</sup> Add the food at the start.

<sup>5</sup> Heat the oil with the lid on. Fry one portion after the other without the lid.



Potatoes	Cooking assistance functions	Temperature level	Total cooking time from signal tone (mins)
<b>Frying with a little amount of oil</b>			
Potatoes boiled in their skin <sup>1</sup>		5	6 - 12
Fried potatoes (made from raw potatoes) <sup>1</sup>		4	15 - 25
Potato pancakes <sup>2</sup>		5	2,5 - 3,5
Swiss rösti <sup>3</sup>		2	50 - 55
Glazed potatoes <sup>1</sup>		3	10 - 15
<b>Simmering</b>			
Potato dumplings <sup>4</sup>		85 °C	30 - 40
<b>Boiling</b>			
Boiling potatoes <sup>5</sup>		100 °C	30 - 45
<b>Cooking in a pressure cooker</b>			
Potatoes in a pressure cooker <sup>5</sup>		115 °C	10 - 20







<sup>1</sup> Stir frequently.

<sup>2</sup> Time indicated per portion. Fry individually.

<sup>3</sup> Add the oil and food to the frying pan after the signal sounds.

<sup>4</sup> Heat up and cook with the lid on. Add the food after the signal sounds.





<sup>5</sup> Add the food at the start.

Pasta and cereals	Cooking assistance functions	Temperature level	Total cooking time from signal tone (mins)
<b>Simmering</b>			
Rice <sup>1</sup>		90 °C	25 - 35
Polenta <sup>2</sup>		85 °C	3 - 8
Semolina pudding <sup>2</sup>		85 °C	5 - 10
<b>Boiling</b>			
Pasta <sup>2</sup>		100 °C	7 - 10
Stuffed pasta <sup>2</sup>		100 °C	6 - 15
<b>Cooking in a pressure cooker</b>			
Rice in a pressure cooker <sup>3</sup>		115 °C	5 - 8

<sup>1</sup> Heat up and cook with the lid on. Add the food after the signal sounds.





<sup>2</sup> Stir frequently.

<sup>3</sup> Add the food at the start.



Soups	Cooking assistance functions	Temperature level	Total cooking time from signal tone (mins)
<b>Simmering</b>			
Instant creamy soups <sup>1</sup>		90 °C	10 - 15
<b>Boiling</b>			
Home-made broths <sup>2</sup>		100 °C	60 - 90
Instant soups <sup>1</sup>		100 °C	5 - 10
<b>Cooking in a pressure cooker</b>			
Home-made broths in a pressure cooker <sup>2</sup>		115 °C	20 - 30

<sup>1</sup> Stir frequently.

<sup>2</sup> Add the food at the start.

Sauces	Cooking assistance functions	Temperature level	Total cooking time from signal tone (mins)
<b>Frying with a little amount of oil</b>			
Tomato sauce with vegetables <sup>1</sup>		1	25 - 35
Béchamel sauce <sup>1</sup>		1	10 - 20
Cheese sauce <sup>1</sup>		1	10 - 20
Reducing sauces <sup>1</sup>		1	25 - 35
Sweet sauces <sup>1</sup>		1	15 - 25

<sup>1</sup> Stir frequently.

Desserts	Cooking assistance functions	Temperature level	Total cooking time from signal tone (mins)
<b>Simmering</b>			
Rice pudding <sup>1</sup>		85 °C	40 - 50
Porridge oats <sup>1</sup>		85 °C	10 - 15
Chocolate pudding <sup>1</sup>		85 °C	3 - 5













<b>Boiling</b>			
Compote <sup>2</sup>		100 °C	15 - 25

<b>Deep frying with a large amount of oil</b>			
Deep frying Berliners <sup>3</sup>		160 °C	5 - 10
Deep frying ring doughnuts <sup>3</sup>		160 °C	5 - 10
Deep frying buñuelos <sup>3</sup>		160 °C	5 - 10

<sup>1</sup> Stir frequently.

<sup>2</sup> Add the food at the start.

<sup>3</sup> Heat the oil with the lid on. Fry one portion after the other without the lid.



Frozen products	Cooking assistance functions	Temperature level	Total cooking time from signal tone (mins)
<b>Frying with a little amount of oil</b>			
Escalope <sup>1</sup>		4	15 - 20
Cordon bleu <sup>1</sup>		4	10 - 30
Poultry breast <sup>1</sup>		4	10 - 30
Chicken nuggets <sup>1</sup>		4	10 - 15
Gyros <sup>2</sup>		4	10 - 15
Kebab <sup>2</sup>		4	10 - 15
Fish fillet, plain <sup>1</sup>		3	10 - 20
Fish fillet, breaded <sup>1</sup>		3	10 - 20
Fish fingers <sup>1</sup>		4	8 - 12
Fry French fries <sup>2</sup>		5	4 - 6
Stir-fries <sup>2</sup>		3	6 - 10
Spring rolls <sup>1</sup>		4	10 - 30
Camembert <sup>1</sup>		3	10 - 15

<sup>1</sup> Turn frequently.

<sup>2</sup> Stir frequently.

<sup>3</sup> Heat up and cook with the lid on. Add the food after the signal sounds.

<sup>4</sup> Heat the oil with the lid on. Fry one portion after the other without the lid.









Frozen products	Cooking assistance functions	Temperature level	Total cooking time from signal tone (mins)
<b>Keeping warm, heating</b>			
Vegetable in cream sauce <sup>2</sup>		70 °C	15 - 20
<b>Boiling</b>			
Green beans, frozen <sup>3</sup>		100 °C	15 - 30
<b>Fry with a large amount of oil</b>			
Deep-frying French Fries <sup>4</sup>		180 °C	4 - 8

<sup>1</sup> Turn frequently.

<sup>2</sup> Stir frequently.

<sup>3</sup> Heat up and cook with the lid on. Add the food after the signal sounds.

<sup>4</sup> Heat the oil with the lid on. Fry one portion after the other without the lid.

Other	Cooking assistance functions	Temperature level	Total cooking time from signal tone (mins)
<b>Frying with a little amount of oil</b>			
Camembert <sup>1</sup>		3	7 - 10
Croûtons <sup>2</sup>		3	6 - 10
Dried ready meals <sup>3</sup>		1	5 - 10
Toasting almonds <sup>4</sup>		4	3 - 15
Toasting nuts <sup>4</sup>		4	3 - 15
Toasting pine nuts <sup>4</sup>		4	3 - 15
<b>Keeping warm, heating</b>			
Heating goulash soup <sup>5</sup>		70 °C	10 - 20
Heating mulled wine <sup>5</sup>		70 °C	5 - 15
<b>Simmering</b>			
Heating milk <sup>5</sup>		85 °C	3 - 10

<sup>1</sup> Turn frequently.

<sup>2</sup> Stir frequently.

<sup>3</sup> Add the water after the signal sounds. Add the food as soon as the water boils.

<sup>4</sup> Add the food after the signal tone sounds.

<sup>5</sup> Add the food at the start.

## Teppan Yaki and Grill for the Flex Zone

The Teppan Yaki and grill accessories are ideal for the flexible cooking zone and are optimal cookware for using the frying sensor technology.

### Grill

































The Grill adapts to the Flex Zone. You can cook large and small quantities of meat, fish, fresh vegetables and bread with very little oil, healthily and easily. The grooved shape ensures that food absorbs less fat. The ease of operation makes it possible to grill dishes that look and taste like they have been cooked on a traditional grill. Add a little oil to the grill or the surface of the food to facilitate heat transfer.

### Teppan Yaki

The Teppan Yaki enables you to cook meat, fish, seafood, vegetables, desserts and bread with very little oil, easily and healthily. The Teppan Yaki adapts perfectly to the Flex Zone. Direct contact with the plate and uniform heat transfer make it possible to retain the consistency, colour and succulence of the food when searing and browning.

The following table shows a selection of dishes and is arranged by food type. The temperature and the cooking time depend on the amount, the condition and the quality of the food.

**Note:** Set up the Flex Zone as a single cooking zone to ensure the function is activated correctly.

	Cookware	Temperature level	Total frying time after the signal tone sounds (min)
<b>Meat</b>			
Escalope, plain <sup>1</sup>	 / 	4	6 - 10
Fillet <sup>1</sup>	 / 	4	6 - 10
Chops <sup>1</sup>	 / 	3	10 - 15
Steak, rare (3 cm thick) <sup>1</sup>	 / 	5	6 - 8
Steak, medium (3 cm thick) <sup>1</sup>	 / 	5	8 - 12
Steak, well done (3 cm thick) <sup>1</sup>	 / 	4	8 - 12
Poultry breast (2 cm thick) <sup>1</sup>	 / 	3	10 - 20
Bacon <sup>1</sup>	 / 	3	5 - 8
Hamburgers <sup>1</sup>	 / 	3	6 - 15
Boiled sausages <sup>1</sup>	 / 	4	8 - 20
Raw sausages <sup>1</sup>	 / 	4	8 - 20
Gyros <sup>2</sup>		4	7 - 12
Minced meat <sup>2</sup>		4	6 - 10
<b>Fish and seafood</b>			
Fish fillet, plain <sup>1</sup>	 / 	4	10 - 20
Scampi <sup>1</sup>	 / 	4	4 - 8
Prawns <sup>1</sup>	 / 	4	4 - 8
Frying fish, whole <sup>1</sup>	 / 	3	15 - 30

<sup>1</sup> Add oil (if necessary) and the food after the signal tone sounds. Turn if necessary.





























<sup>2</sup> Add oil (if necessary) and the food after the signal tone sounds. Stir regularly.

<sup>3</sup> Add butter and the food after the signal tone sounds. Turn if necessary.

<sup>4</sup> Add oil (if necessary) and the food after the signal tone sounds. Total cooking time per portion. Fry individually.

<sup>5</sup> Add oil (rub into the food) and the food after the signal tone sounds. Turn if necessary.

<sup>6</sup> Add the food after the signal tone sounds.

	Cookware	Temperature level	Total frying time after the signal tone sounds (min)
<b>Vegetables</b>			
Courgettes <sup>1</sup>	 / 	3	4 - 12
Aubergines <sup>1</sup>	 / 	3	4 - 12
Peppers <sup>1</sup>	 / 	3	4 - 15
Frying green asparagus <sup>1</sup>	 / 	3	4 - 15
Mushrooms <sup>2</sup>	 / 	4	10 - 15
Garlic <sup>2</sup>		2	2 - 10
Sweating onions <sup>2</sup>		2	2 - 10
Glazing vegetables <sup>2</sup>		3	6 - 10
<b>Potatoes</b>			
Fried potatoes (made from unpeeled boiled potatoes) <sup>2</sup>		5	6 - 12
Potato pancakes <sup>4</sup>		5	2,5 - 3,5
Glazed potatoes <sup>2</sup>		3	10 - 15
<b>Egg dishes</b>			
Fried eggs in butter <sup>3</sup>		2	2 - 6
Fried eggs in oil <sup>1</sup>		4	2 - 6
Scrambled eggs <sup>2</sup>		2	4 - 9
Omelettes <sup>4</sup>		2	3 - 6
Pancakes <sup>4</sup>		5	1,5 - 2,5
French toast <sup>4</sup>		3	4 - 8
Shredded raisin pancake <sup>4</sup>		3	10 - 15
<b>Miscellaneous</b>			
Toasting <sup>5</sup>	 / 	4	4 - 6
Croûtons <sup>2</sup>		3	6 - 10
Toasting almonds <sup>6</sup>		4	3 - 15
Toasting nuts <sup>6</sup>		4	3 - 15
Toasting pine nuts <sup>6</sup>		4	3 - 15

<sup>1</sup> Add oil (if necessary) and the food after the signal tone sounds. Turn if necessary.

<sup>2</sup> Add oil (if necessary) and the food after the signal tone sounds. Stir regularly.

<sup>3</sup> Add butter and the food after the signal tone sounds. Turn if necessary.

<sup>4</sup> Add oil (if necessary) and the food after the signal tone sounds. Total cooking time per portion. Fry individually.

<sup>5</sup> Add oil (rub into the food) and the food after the signal tone sounds. Turn if necessary.

<sup>6</sup> Add the food after the signal tone sounds.

## Wireless temperature sensor

Before you use the cooking sensor functions for the first time, connect the wireless temperature sensor to the control panel.

### Preparing and maintaining the wireless temperature sensor

This section provides information on:

- Adhering the silicone patch
- Attaching the wireless cooking sensor
- Cleaning
- Changing the battery

Silicone patches and cooking sensors can be purchased from specialist retailers, our technical after-sales service or our official website. Please quote the relevant reference number when doing so:

00577921 Set of 5 silicone patches  
CA060300 Cooking sensor and set of 5 silicone patches

#### Adhering the silicone patch

The silicone patch secures the cooking sensor to the cookware.

If you are using a pot with the cooking sensor functions for the first time, attach the silicone patch directly onto the pot. Proceed as follows:

- 1 That the adhesive area on the pan is free from grease. Clean the pan, dry it thoroughly and wipe the adhesive area with a spirit.
- 2 Remove the protective film from the silicone patch. Adhere the silicone patch to the outside of the pan in the correct place using the enclosed template as a guide.

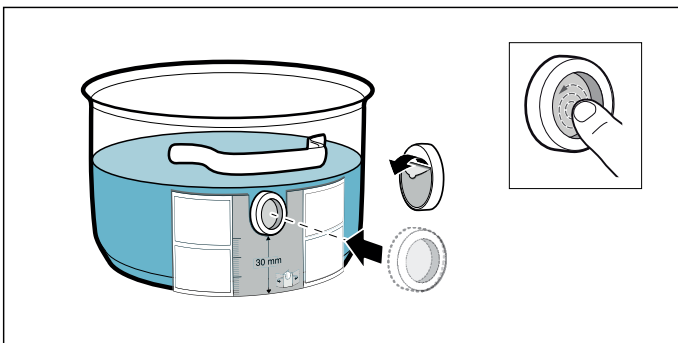

- 3 Press down all over the surface of the silicone patch, including in the centre.

The adhesive requires one hour to fully harden. Do not use or clean the pan during this time.

#### Notes

- Do not leave the pan with the silicone patch to soak soapy water for long periods of time.
- If the silicone patch comes off, attach a new one.

#### Fitting the wireless temperature sensor

Attach the temperature sensor to the silicone patch and align it correctly.

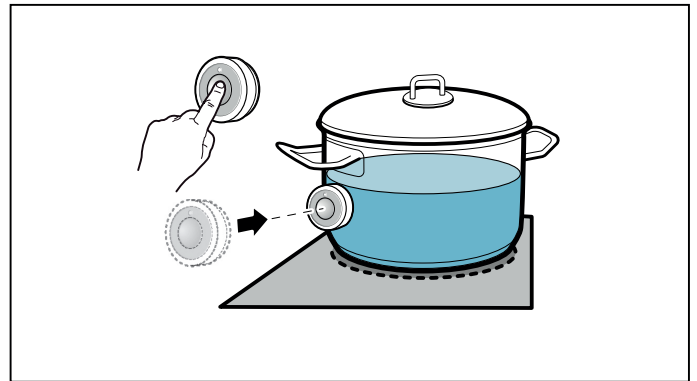

#### Notes

- Make sure that the silicone patch is completely dry before attaching the temperature sensor.
- Position the cookware in such a way that the temperature sensor is pointing towards the outer side of the hob.
- To prevent overheating, the temperature sensor must not be pointed towards another item of cookware that is hot.
- Remove the temperature sensor from the saucepan after cooking. Store it in a clean, safe place away from sources of heat.
- You can use up to three temperature sensors at the same time.

### Connecting the wireless temperature sensor to the control panel

To connect the wireless cooking sensor to the control panel, proceed as follows:

- 1 Select the basic setting  $\square 5$ ; see the section entitled  $\rightarrow$  "Basic settings". The  $\square$  symbol lights up white.
- 2 Touch the  $\square$  symbol. A signal sounds and the  $\square$  symbol lights up orange. The cooking zone indicators light up white and the cooking sensor indicators on the hotplates flash. Briefly touch the  $\square$  symbol on the wireless cooking sensor within the next 30 seconds.

- 3 Detection successful:** The wireless temperature sensor is detected within a few seconds. Three short beeps sound and the  symbol changes from orange to white. The cooking sensor indicators on the cooking zones go out.

**Detection failed:** Five beeps will sound. The  symbol immediately changes from orange to white and the cooking sensor indicators on the cooking zones go out.

- The cooking functions are made available as soon as the wireless cooking sensor has been connected to the control panel correctly.
  - If there is a fault with the wireless cooking sensor, the connection may not be established correctly for the following reasons:
    - Bluetooth communication error.
    - You have not pressed the  symbol on the cooking sensor within 30 seconds of selecting the cooking zone.
    - The battery in the wireless cooking sensor is almost flat.
 Reset the wireless cooking sensor and repeat the connection procedure.
  - If there are problems with the connection due to a transmission error, repeat the connection procedure.
- If a connection cannot be established, inform the after-sales service.

### Resetting the wireless temperature sensor

- 1 Touch and hold the  symbol for approximately 8-10 seconds. While you are doing this, the temperature sensor's LED indicator will light up three times. When the LED lights up for the third time, it will start to reset the temperature sensor. At this point, you will need to lift your finger off the symbol. Once the LED goes out, this means that the wireless temperature sensor has been reset.
- 2 Repeat the connection procedure from point 2.

## Cleaning

Do not clean the wireless temperature sensor in the dishwasher.

### Temperature sensor

Clean the temperature sensor with a damp cloth. Never clean it in the dishwasher. Do not immerse it in water or clean it under running water.

Remove the temperature sensor from the saucepan after cooking. Store it in a clean, safe place (such as in its packaging) away from sources of heat.

### Silicone patch

Clean and dry before attaching to the temperature sensor. Dishwasher safe.

**Note:** Cookware with the silicone patch must not be left to soak for long periods in soapy water.

### Temperature sensor window

The sensor window must always be clean and dry. Proceed as follows:

- Remove dirt and oil splatters regularly.
- Use a soft cloth or cotton buds and window cleaner for cleaning.

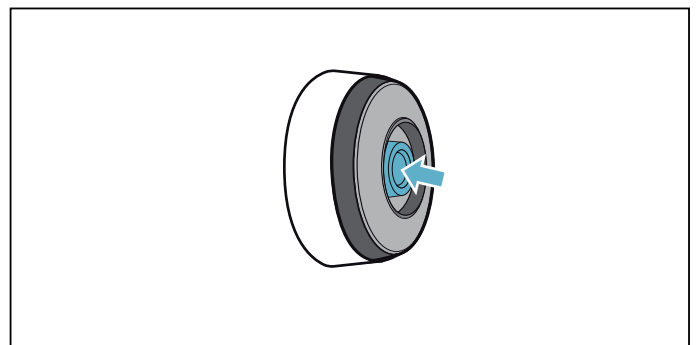

### Notes

- Do not use abrasive cleaning agents such as scouring pads, scrubbing brushes or cream cleaners.
- Do not touch the sensor window with your fingers. This may make it dirty or scratch it.

## Changing the battery

If the temperature sensor does not light up when the symbol is pressed, the battery is flat.

Changing the battery:

- 1 Remove the silicone cover from the lower section of the temperature sensor housing and remove both screws using a screwdriver.

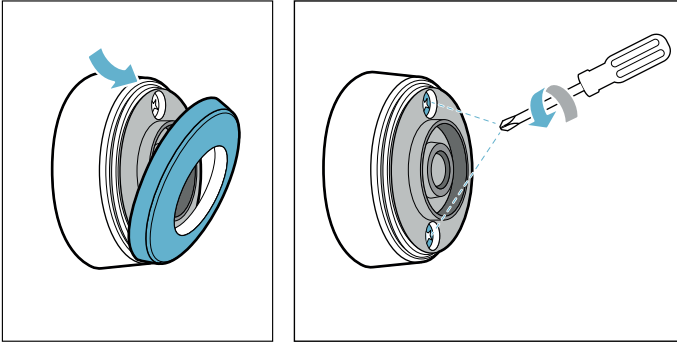

- 2 Open the closure of the temperature sensor. Remove the battery from the lower section of the housing and insert a new battery (pay attention to the correct orientation of the battery poles).

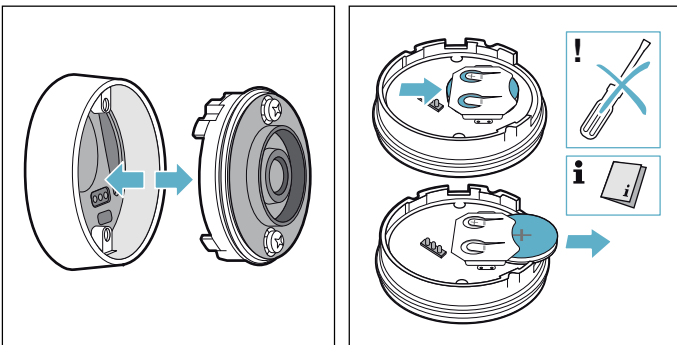

### Caution!

Do not use any metal objects to remove the battery.  
Do not touch the battery connection points.

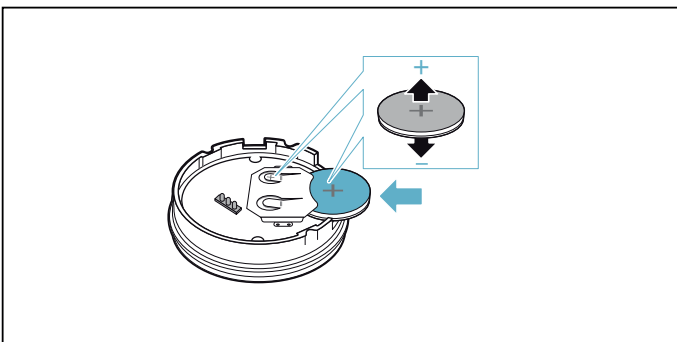

- 3 Close the closure of the temperature sensor (the notches for the screws on the closure must align with the notches on the lower section of the housing). Tighten the screws with a screwdriver.

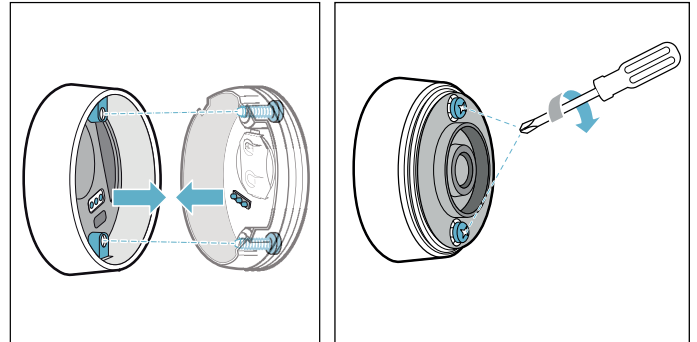

- 4 Reattach the silicone cover to the lower section of the temperature sensor housing.

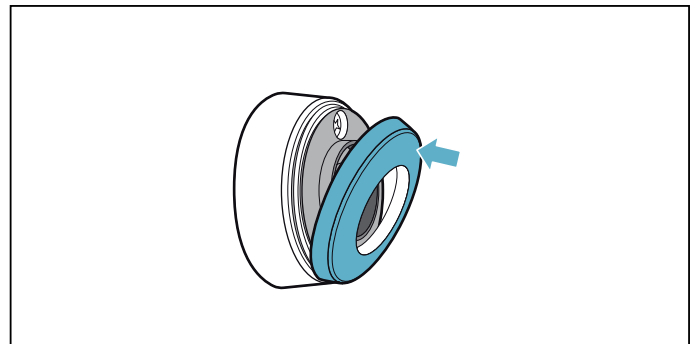

**Note:** Use only high-quality batteries of the type CR2032 in order to guarantee a long service life.

## Declaration of Conformity

Gaggenau Hausgeräte GmbH hereby declares that the appliance with wireless temperature sensor function meets the basic requirements and other relevant provisions of the Directive 2014/53/EU.

A detailed RED Declaration of Conformity can be found online at [www.gaggenau.com](http://www.gaggenau.com) on the product page for appliance in the additional documents.

The logos and the Bluetooth® brand are registered trademarks and property of Bluetooth SIG, Inc. These trademarks are used by Gaggenau Hausgeräte GmbH under licence. All other trademarks and brand names are owned by the respective companies.



---

## Childproof lock

---

### Activating and deactivating the childproof lock

The hob must be switched off.

To activate: Remove the twist knob from the hotplate. A signal sounds. The  indicator lights up for 10 seconds. The hob is locked.

To deactivate: Place the twist knob on the twistpad.

**Note:** Removing the twist knob when the hotplate is switched on initially activates the display cleaning protection function. If the twist knob is not put back on after 10 minutes, the hotplate switches itself off and the child lock is activated.

---

## Display cleaning protection

---

If you wipe over the control panel while the hob is switched on, settings may be changed. To avoid this, the hob has a function you can use to lock the control panel for cleaning.

**To activate:** Remove the twist knob. An audible signal sounds. The  indicator and the hob settings flash. The heating process is interrupted. If a cooking timer is set, it will be paused. The control panel is locked for 10 minutes. You can now wipe over the surface of the control panel without altering the settings.

**To deactivate:** Put the twist knob back on within 10 minutes. The control panel is unlocked. The hob continues operating with the previous settings. To end the function early, put the twist knob back on before the 10 minutes have elapsed.

---

## Automatic safety cut-out

---

If a hotplate operates for an extended period and no settings are changed, the automatic safety shut-off is activated.

The hotplate stops heating. A signal sounds and the residual heat indicator *h* or *H* appears in the hotplate display.

When you touch any symbol, the display switches off. The hotplate can now be set again.

The point at which the safety shut-off becomes active depends on which heat setting has been set (after 1 to 10 hours).

---

## Basic settings

---

The appliance has various basic settings. These basic settings can be altered to suit your individual requirements.

Display	Function
	<b>Signal tones</b>
<i>c 1</i>	<i>00</i> All signals are switched on.* <i>0FF</i> Most of the signals are switched off.
	<b>Time for selecting the hotplate</b>
<i>c 2</i>	<i>5</i> The hotplate remains selected for 5 seconds. <i>10</i> The hotplate remains selected for 10 seconds.* <i>15</i> The hotplate remains selected for 15 seconds. <i>0FF</i> Unlimited: The hotplate which was set last remains selected.
	<b>Power management function. Limiting the total power of the hob</b>
<i>c 3</i>	<i>0</i> Deactivated. Maximum power of the hob.** <i>1</i> 1000 W minimum power. <i>1.5</i> 1500 W ... <i>3</i> 3000 W recommended for 13 A. <i>3.5</i> 3500 W recommended for 16 A. <i>4</i> 4000 W <i>4.5</i> 4500 W recommended for 20 A. ... <i>9</i> or <i>9.5</i> Maximum power of the hob.**
	<b>Restoring the factory settings</b>
<i>c 4</i>	<i>0FF</i> Keep personal settings.* <i>00</i> Restore factory settings.
	<b>Cooking sensor</b>
<i>c 5</i>	Connect the wireless cooking sensor to the hob. Set according to height above sea level: <i>1-2</i> Decrease <i>3</i> Basic setting <i>4-9</i> Increase
	<b>Professional cooking function</b>
<i>c 6</i>	Select a single cooking zone in order to preset the power level for the professional cooking function.
	<b>Cookware, checking the result of the cooking process</b>
<i>c 7</i>	<i>0</i> Not suitable <i>1</i> Not perfect <i>2</i> Suitable
	<b>Home Connect</b>
<i>c 9</i>	→ "Home Connect settings" on page 45

\* Factory setting



\*\*The hob's maximum power output is shown on the rating plate.

## To access the basic settings:

The hob must be off.

- 1 Switch on the hob.
- 2 Touch the  symbol within the next 10 seconds.  
The first four displays provide product information.  
Turn the twist knob to view the individual displays.

Product information	Display screen
After-sales service index (ASSI)	01
Production number	Fd
Production number 1	95.
Production number 2	05

- 3 Touch the  symbol again to access the basic settings.  
 and  light up as a presetting in the displays.

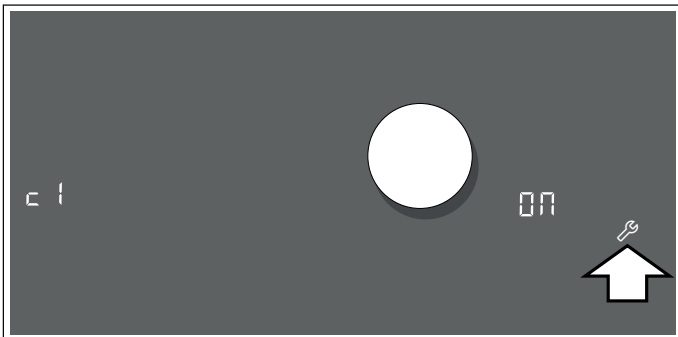

- 4 Touch the  symbol repeatedly until the required function is displayed.
- 5 Then use the twist knob to select the required setting.

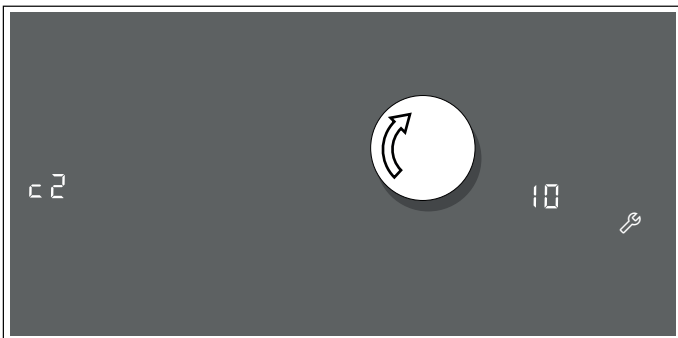

- 6 Touch the  symbol for at least 4 seconds.

The settings have been saved.

### Leaving the basic settings

Turn off the hob with the main switch.

## Home Connect

This appliance is WLAN-enabled and settings can be sent to the appliance via a mobile device.

If the appliance is not connected to the home network, the appliance functions in the same way as a hob with no network connection. The hob can always be operated via the control panel.

The availability of the Home Connect function depends on the availability of Home Connect services in your country. Home Connect services are not available in every country. You can find more information on this at [www.home-connect.com](http://www.home-connect.com).

### Notes

- Hobs are not designed to be used unattended - you must always keep an eye on the cooking process.
- Ensure that you follow the safety instructions in this instruction manual and that these are also observed when operating the appliance via the Home Connect app. You must also follow the instructions in the Home Connect app. → "Important safety information" on page 6
- Using the Home Connect app, you can send settings to your appliance and then have to confirm them on the appliance. It is not possible to operate the appliance whilst you are away from home.
- Operation on the appliance always has priority. During this time, it is not possible to operate the appliance using the Home Connect app.

## Setting up

To implement settings via Home Connect, you must have installed and set up the Home Connect app on your mobile device.

**Note:** In networked standby mode, your appliance requires max. 2 W.

### Setting up the Home Connect app



**Note:** You require a mobile device with the latest version of the relevant operating system.

- 1 On your mobile device go to the App Store (Apple devices) or to the Google Play Store (Android devices).
- 2 Enter "Home Connect" in the search field.
- 3 Select the Home Connect app and install on your mobile device.
- 4 Start the app and create your Home Connect login details. The app will guide you through the registration process. Make a note of your e-mail address and password.



### Automatic registration in the home network

You require a router that has WPS functionality. You will find information about this in the manual for your router. You require access to your router.

If you do not have this, follow the steps for "Manually logging into your home network".

- 1 Open the basic settings.
- 2 Touch the  symbol repeatedly until the *c9HC* setting appears.
- 3 Touch the  symbol to open the Home Connect settings.  
*HC 1* and *NET* will flash alternately in the settings area. *OFF* will be lit on the hotplate display.



- 4 Set the value to *CO 1* using the twist knob. *CO 1* will flash on the hotplate display along with the  symbol.
- 5 Press the WPS button on the router within the next 2 minutes. The  symbol will stop flashing on the control panel and will remain continuously lit when the hob is connected to your network.

**Note:** If a connection cannot be established, the value *CO 2*, "Connect manually", will appear. Log the appliance into your home network manually or try connecting automatically again.

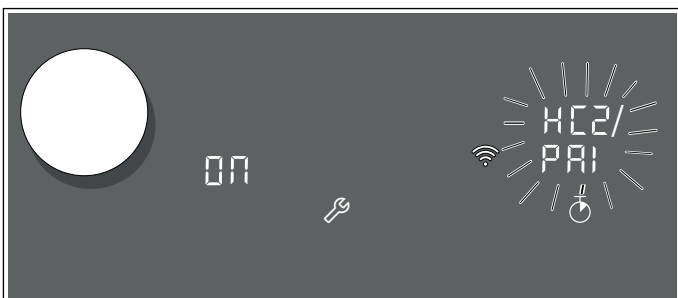



The appliance will automatically try to connect to the app. *HC 2* and *PRI* will flash alternately in the settings area. The value *ON* will flash on the hotplate display.

- 6 Launch the app on your mobile device and follow the instructions for automatic network login.

When the value *ON* stops flashing on the hotplate display and the value *OFF* lights up again, the login process is complete.

### Manual registration in the home network

**Note:** To manually log into your home network (Wi-Fi), you will need the network name (SSID) and password (key).

- 1 Open the basic settings.
- 2 Touch the  symbol repeatedly until the *c9HC* setting appears.
- 3 Touch the  symbol to open the Home Connect settings.  
*HC 1* and *NET* will flash alternately in the settings area. *OFF* will be lit on the hotplate display.



- 4 Set the value to *CO 2* using the twist knob. *CO 2* will flash on the hotplate display along with the  symbol.

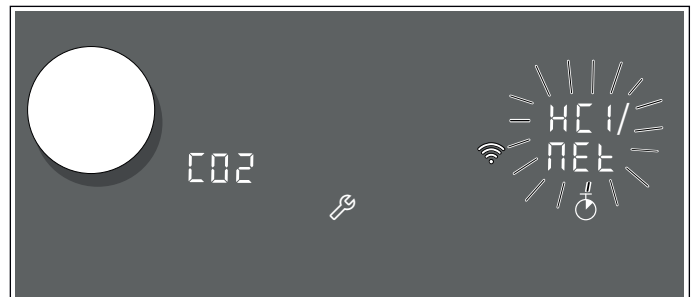

- 5 Go to the general settings menu on your mobile device and call up the Wi-Fi settings.

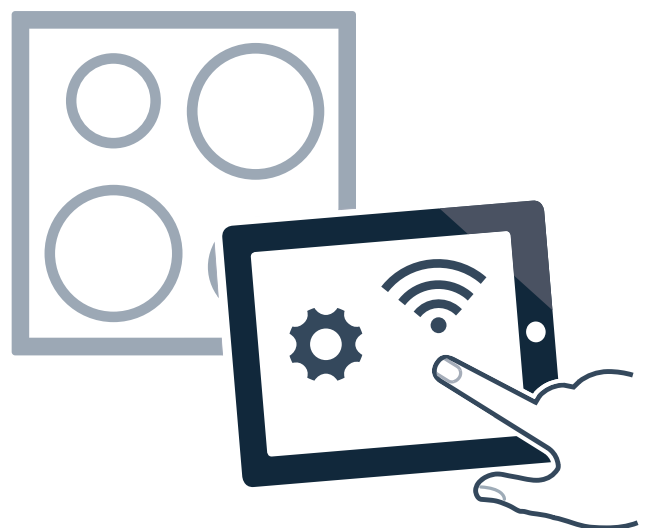

- 6 Use the SSID "Home Connect" and the key "Home Connect" to log your mobile device into the hob network. It can take up to 60 seconds to connect.
- 7 Once it is connected successfully, open the Home Connect app.  
The app will now take a few seconds to search for your hob. Once the hob has been found, you will be prompted to enter the name (SSID) and password (key) for your home network (Wi-Fi) into the corresponding fields if you have not already done so.
- 8 Then press "Transfer to household appliance".
- 9 The  symbol will light up on the control panel when the hob is connected to your home network.



The appliance will automatically try to connect to the app. *HC2* and *PA1* will flash alternately in the settings area. The value *00* will flash on the hotplate display.

When the value *00* stops flashing on the hotplate display and the value *OFF* lights up again, the login process is complete.

You can then reconnect your mobile device to your home network.

Follow the instructions in the app.

## Home Connect settings

You can adjust Home Connect to suit your requirements at any time.

In the basic settings for your hob, navigate to the Home Connect settings to display network and appliance information.

Indicator/ symbol	Function
<i>HC1/NET</i>	<b>Home network login (Wi-Fi)</b>
<i>OFF</i>	Not connected /disconnect network
<i>CO1</i>	Connect automatically
<i>CO2</i>	Connect manually
<i>ON</i>	Connected
<i>HC2/PA1</i>	<b>Connection to app</b>
<i>OFF</i>	Not connected/ login process complete
<i>ON</i>	Connect
<i>HC3/CON</i>	<b>Connection to home network (Wi-Fi)</b>
<i>OFF</i>	Wireless module switched off
<i>ON</i>	Wireless module switched on
<i>HC4/FES</i>	<b>Settings via app</b>
<i>OFF</i>	Switched off
<i>ON</i>	Switched on*
<i>HC5/UPd</i>	<b>Software update</b>
<i>dEF</i>	Update available and ready for installation
<i>INS</i>	Start installation
<i>HC6/Ed</i>	<b>Remote access by after-sales service</b>
<i>OFF</i>	Not authorised
<i>ON</i>	Authorised
<i>HC7/SEF</i>	<b>Wi-Fi signal strength</b>
<i>NA</i>	Not connected to home network (Wi-Fi)
<i>1</i>	Signal strength 1 (weak)
<i>2</i>	Signal strength 2 (moderate)
<i>3</i>	Signal strength 3 (good)
<i>HC8/SEF</i>	<b>Connection to Home Connect server</b>
<i>NA</i>	Not connected
<i>ON</i>	Connected

\* Basic setting

### Notes

- The **HC2** setting is only displayed if the appliance is connected to your home network.
- The **HC3** setting is only displayed if the appliance has previously been connected to a network.
- The **HC5** setting is only displayed if an update is available.
- The **HC6** setting is only displayed if the after-sales service is attempting to connect to the appliance. You can end this at any time after granting access.
- The **HC7** and **HC8** settings are only displayed if there is Wi-Fi connection.

### Deactivating WLAN

If Wi-Fi has been activated, you can use the Home Connect functions.

**Note:** In networked standby mode, your appliance requires a maximum of 2 W.

- 1 Open basic setting **c9**.
- 2 Touch the  symbol repeatedly until the **HC3** and **CON** settings flash alternately. **ON** will be lit on the hotplate display.

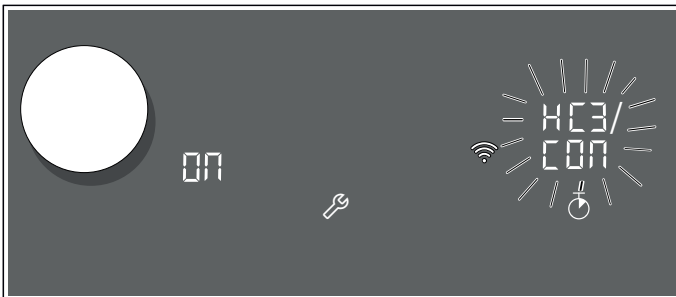

- 3 Set the value to **OFF** using the twist knob.

This deactivates Wi-Fi; the  symbol will go out on the control panel.

**Note:** The network settings will be stored. When the WiFi function is activated again, the hob will try to reconnect to the previously stored network.

### Disconnecting from the network

You can disconnect your hob from the network at any time.

**Note:** If your hob is disconnected from the network, it is not possible to operate it using Home Connect.

- 1 Open basic setting **c9**.
- 2 Touch the  symbol repeatedly until the **HC1** and **NET** settings flash alternately. **ON** will be lit on the hotplate display.
- 3 Set the value to **OFF** using the twist knob.

This disconnects the appliance from your home network; the  symbol will go out on the control panel.

### Connecting to the network

- 1 Open basic setting **c9**.
- 2 Touch the  symbol repeatedly until the **HC1** and **NET** settings flash alternately. **OFF** will be lit on the hotplate display.



- 3 Use the twist knob to set the value to **CO1**, "Connect automatically", or **CO2**, "Connect manually".
- 4 Follow the instructions in the section entitled "Automatic login to your home network" or "Manually logging into your home network".

### Connect to the app

If the Home Connect app is installed on your mobile device, you can connect it to your hob.

### Notes

- The appliance must be connected to the network.
- The app must be open and be set up.
- If your extractor hood is directly connected, first disconnect the hob from your home network and then initiate the connection process again.
  - "Disconnecting from the network" on page 46,
  - "Connecting to the network" on page 44

- 1 Open basic setting **c9**.
- 2 Touch the  symbol repeatedly until the **HC2** and **PA1** settings flash alternately. **OFF** will be lit on the hotplate display.

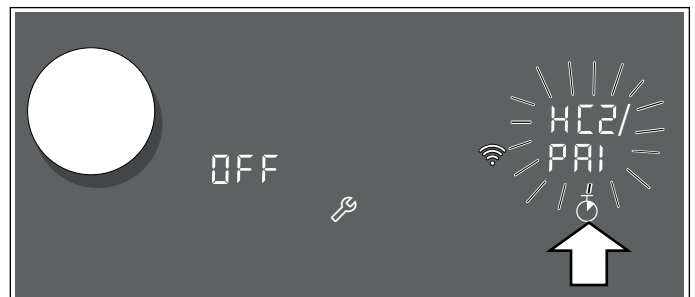

- 3 Set the value to **ON** using the twist knob.
- 4 Launch the app on your mobile device and follow the instructions in the app to complete the connection process.

When the value **ON** stops flashing on the hotplate display and the value **OFF** lights up again, the login process is complete.

## Settings via app

Using the Home Connect app, you can easily access the basic settings for your hob and send settings for the hotplates to the hob.

### Notes

- Before you can change the basic settings, the hob must be switched off.
- If the appliance is being operated by means of the controls on the appliance itself, this mode of operation always has priority. During this time, it is not possible to operate the appliance using the Home Connect app.
- The appliance is supplied with the settings transmission option activated.
- If the settings transmission option has been deactivated, only the hob's operating statuses will be displayed in the Home Connect app.

- 1 Open basic setting **c9**.
- 2 Touch the  symbol repeatedly until the **HC4** and **FES** settings flash alternately.
- 3 To activate the settings transmission option, select the value **ON** with the twist knob. To deactivate the settings transmission option, select the value **OFF**.

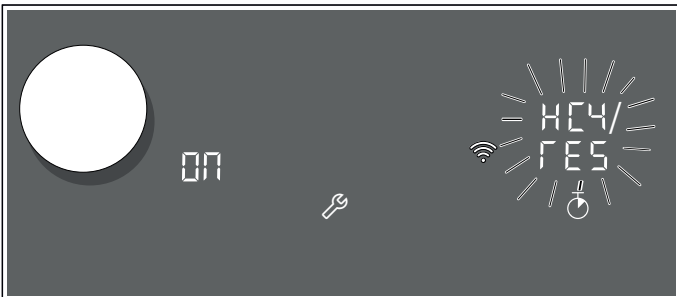

### Confirming settings

As soon as cooking settings are transmitted to a hotplate, the hotplate indicator will start to flash. To confirm that you want to use these settings, touch the flashing indicator . To reject these settings, touch any other button on the hob.

## Software update

Using the software update function, your hob's software can be updated (e.g. for the purpose of optimisation, troubleshooting or security updates). To do this, you need to be a registered Home Connect user, have installed the app on your mobile device and be connected to the Home Connect server.

As soon as a software update is available, you will be informed by the Home Connect app, from which you will also be able to download the update.

Once the update has been successfully downloaded, you can start installing it via the hob (basic settings, settings **c9**, setting **HC5/UPd**) or the Home Connect app if you are on your local area network.

The Home Connect app will notify you once installation is complete.

### Notes

- You can continue to use your hob as normal while updates are downloading.
- Depending on your personal settings in the app, software updates can also be set to download automatically.
- We recommend that you install security updates as soon as possible.

## Remote diagnostics

If a fault occurs, the after-sales service can use remote diagnostics to access your appliance.

Contact the after-sales service, making sure that your appliance is connected to the Home Connect server and checking that the remote diagnostics service is available in your country.

**Note:** For more information and to check whether the remote diagnostics service is available in your country, please visit the Help & Support area of the Home Connect website for your country: [www.home-connect.com](http://www.home-connect.com)

## About data protection

When your appliance is connected for the first time to a WLAN network, which is connected to the Internet, your appliance transmits the following categories of data to the Home Connect server (initial registration):

- Unique appliance identification (consisting of appliance codes as well as the MAC address of the installed WiFi communication module).
- Security certificate of the WiFi communication module (to ensure a secure IT connection).
- The current software and hardware version of your domestic appliance.
- Status of any previous resetting to factory settings.

This initial registration prepares the Home Connect functions for use and is only required when you want to use these Home Connect functions for the first time.

**Note:** Ensure that the Home Connect functions can be used only in conjunction with the Home Connect app. Information on data protection can be accessed in the Home Connect app.

## Declaration of Conformity

Gaggenau Hausgeräte GmbH hereby declares that the appliance which features Home Connect is in accordance with the basic requirements and the other relevant provisions of the directive 2014/53/EU.

A detailed RED Declaration of Conformity can be found online at [www.gaggenau.com](http://www.gaggenau.com) on the product page for appliance in the additional documents.



2.4 GHz band: max. 100 mW  
5 GHz band: max. 100 mW

	BE	BG	CZ	DK	DE	EE	IE	EL
	ES	FR	HR	IT	CY	LV	LT	LU
	HU	MT	NL	AT	PL	PT	RO	SI
	SK	FI	SE	UK	NO	CH	TR	

5 GHz Wi-Fi: for indoor use only

## Hood connection

You can connect this appliance to a suitable extractor hood and then control the functions of the hood via your hob.

There are various options for connecting the appliances together:

### Home Connect

Two appliances can be connected using the Home Connect app provided that both of them are Home Connect-compatible.

Refer to the Home Connect documents supplied for more information.



### Connecting appliances directly

If the appliance is connected directly to an extractor hood, it cannot be connected to your home network as well. The appliance functions as a hob with no network connection. The hob can always be operated via the control panel.

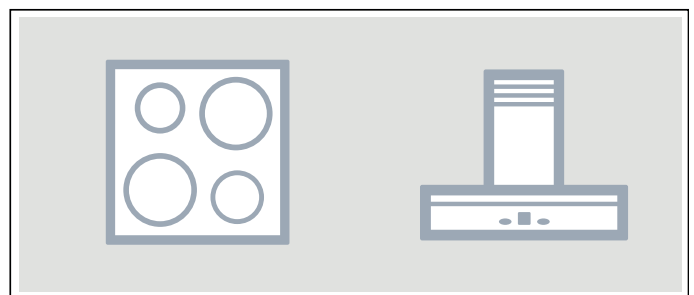



## Connecting appliances via your home network

If the appliances are connected to each other via your home network, both the hood controls and Home Connect can be used to operate the hob.

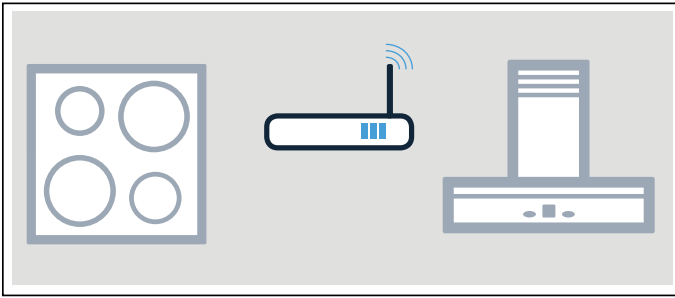

### Notes

- Make sure you follow the safety instructions in the instruction manual for your extractor hood and that these are complied with even when operating the appliance via the hood controls on the hob. → "Important safety information" on page 6
- If the appliance is being operated by means of the controls on the extractor hood, this mode of operation always has priority. It is not possible to use the hood controls on the hob during this time.
- In networked standby mode, your appliance requires a maximum of 2 W.

## Setting up

To set up the connection between the hob and cooker hood, the hob must be switched on.

### Connecting directly

Make sure that the extractor hood is switched off.

For more information, refer to the section entitled "Connecting to the hob" in the instruction manual for your extractor hood.

**Note:** If you connect your hob directly to the extractor hood, it cannot be connected to your home network as well and you will not be able to use Home Connect.

- 1 Open the basic settings.
- 2 Touch the  symbol repeatedly until the  $\epsilon E$  setting appears.  
 $OFF$  will be lit on the hotplate display.
- 3 Set the value to  $i$  using the twist knob.  
 $i$  will flash on the hotplate display.
- 4 You have 2 minutes to initiate the connection process on the extractor hood.

Once the hob is connected to the extractor hood, the value  $ON$  appears on the hotplate display. The symbols for the hood controls on the hob are displayed on the hob's control panel.

## Connecting via your home network

You require a router that has WPS functionality.

You require access to your router. If you do not have this, follow the steps for "Direct connection".

When you begin, make sure that the extractor hood is on your home network.

- 1 Open the basic settings.
- 2 Touch the  symbol repeatedly until the  $\epsilon E$  setting appears.  
 $OFF$  will be lit on the hotplate display.
- 3 Set the value to  $i$  using the twist knob.  
 $i$  will flash on the hotplate display.
- 4 Press the WPS button on the router within the next 2 minutes.  
The hob will be connected to your home network and the value  $\epsilon$  will appear on the hotplate display.
- 5 Initiate the process for connecting to the extractor hood.

Once the hob is connected to the extractor hood, the value  $ON$  appears on the hotplate display. The symbols for the hood controls on the hob are displayed on the hob's control panel.

**Note:** Connection can only be established when both appliances are connected to your home network and the connection process has been initiated for both of them. If the connection process has already timed out for one of the two appliances, try to connect again (basic settings,  $\epsilon E$  setting).

## Resetting connection

You can reset the connections you have saved for your home network and extractor hood at any time.

- 1 Open the basic settings.
- 2 Touch the  symbol repeatedly until the  $\epsilon E$  setting appears.
- 3 Set the value to  $OFF$  using the twist knob.

## Control the hood via the hob

In the basic settings of your hob you can adjust the behaviour of your extractor hood depending on the switch-on/off of the hob or individual cooking zones. → "Hood control settings" on page 47

You can select other settings using the control panel.

### Setting the fan







#### Switching on

Touch the  symbol.

#### Setting fan level



Turn the twist knob clockwise or anti-clockwise to adjust the fan setting.

The following settings are possible:

Indicator/ symbol	Function
	Fan off
	Automatic mode The fan starts automatically when steam is produced
	Fan settings Intensity: Low, medium, high
	PowerBoost function
	Intermittent ventilation
	Fan run-on

#### Switching off

To switch the fan off and continue cooking:

- 1 Touch the  symbol.
- 2 Use the twist knob to select the fan setting .

To switch off the hob:

How the fan behaves once the hob is switched off depends on the basic setting you have selected.

If the  symbol is displayed, the fan is in run-on mode.

**Note:** Even once the hob and fan have been switched off, the  symbol will still be faintly visible.

### Setting the hood lighting

You can switch the hood light on and off via the hob's control panel.

















Touch the  symbol.

Depending on the basic settings you have selected, the light will automatically be switched on or off when the hob is switched on or off. → "Hood control settings"

## Hood control settings

You can adapt the hood controls to suit your needs at any time.

Changing the basic settings → "Basic settings"

Indicator/ symbol	Function
<b>cE</b>	<b>Hob-to-hood connection</b>
	Not connected*/disconnect.
	Connect.
	Connected to home network.
	Connected to extractor hood.
<b>cA</b>	<b>Automatic fan switch-on</b>
	Switched off. The hood will need to be switched on manually if required.
	Switched on in automatic mode.* In automatic mode, the hood switches itself on when you switch on one of the cooking zones.
	Switched on in manual mode. The hood switches itself on at the lowest setting when one of the cooking zones is switched on.
	Switched on in manual mode. The hood switches itself on at a medium setting when one of the cooking zones is switched on.
	Switched on in manual mode. The hood switches itself on at the highest setting when one of the cooking zones is switched on.
<b>cb</b>	<b>Fan run-on</b>
	The fan switches itself off when the hob is switched off.
	Switched on in automatic mode.*
	Switched on with standard fan run-on.
	Settings cannot be changed.
<b>cc</b>	<b>Switch light on automatically</b>
	Switched off.*
	Switched on. The light switches itself on when you switch on the hob.
<b>cd</b>	<b>Switch light off automatically</b>
	Switched off.*
	Switched on. The light switches itself off when you switch off the hob.

\* Basic setting

**Note:** The **cA**, **cb**, **cc** and **cd** settings are only displayed if the appliance is connected to an extractor hood.

## Cookware check

This function can be used to check the speed and quality of the cooking process depending on the cookware.



The result is a reference value and depends on the properties of the cookware and the hotplate being used.

- 1 With the cookware still cold, fill it with approx. 200 ml of water and place it on the centre of the hotplate with the diameter that most closely matches that of the base of the cookware.
- 2 Go to the basic settings and select the **c 7** setting.
- 3 Touch the control panel. **—** will flash on the hotplate display.  
The function has now been activated.

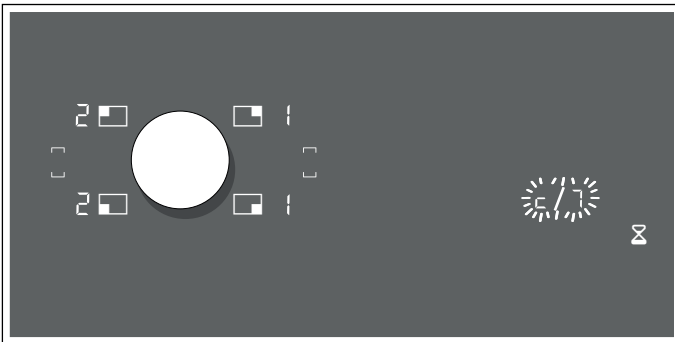
After 10 seconds, the result for the quality and speed of the cooking process will appear in the hotplate display.



Check the result using the following table:

Result	
	The cookware is not suitable for the hotplate and will therefore not heat up.*
	The cookware is taking longer to heat up than expected and the cooking process is not going as well as it should.*
	The cookware is heating up correctly and the cooking process is going well.

\* If there is a smaller hotplate available, test the cookware again on the smaller hotplate.

To reactivate the function, turn the twist knob.

### Notes

- The flexible cooking zone only counts as a single cooking zone; place no more than one item of cookware on it.
- If the diameter of the cooking zone that is used is much smaller than the diameter of the cookware, only the middle of the cookware can be expected to heat up. This may result in the cooking results not being as good as expected or not being satisfactory.
- You can find information on this function in the section entitled → "Basic settings".
- You can find information on the type, size and positioning of the cookware in the sections entitled → "Induction cooking" and → "Flex function".

---

## Power manager

---

You can use the power manager to set the total power of the hob.

The hob is preset at the factory. Its maximum performance is specified on the rating plate. You can use the power manager to change the value in accordance with the requirements for the relevant electrical installation.

In order not to exceed this set value, the hob automatically distributes the power available between the cooking zones that are switched on.

As long as the power manager function is activated, the output of a cooking zone may temporarily fall below the nominal value. If a cooking zone is switched on and the power limit is reached, **\_** appears in the heat setting display for a short time. The appliance automatically regulates and selects the highest possible power level.

For more information about how the total power of the hob is changed, see section → *"Basic settings"*

---

## Cleaning

---

Suitable maintenance and cleaning products can be purchased from the after-sales service or in our e-Shop.

### Hob

#### Cleaning

Always clean the hob after cooking. This will prevent food deposits from becoming burned on. Only clean the hob after the residual heat indicator has gone out.

Clean the hob with a damp dish cloth and dry it with a cloth or towel to prevent limescale build-up.

Only use cleaning agents that are suitable for this type of hob. Observe the manufacturer's instructions on the product packaging.

Never use:

- Undiluted washing-up liquid
- Cleaning agents designed for dishwashers
- Abrasive cleaners
- Harsh cleaning agents, such as oven spray and limescale remover
- Scouring pads
- High-pressure cleaners or steam jet cleaners

Stubborn dirt is best removed with a glass scraper, available from retailers. Observe the manufacturer's instructions.

You can obtain a suitable glass scraper from customer services or through our online shop.

Using a special sponge for cleaning glass-ceramic hobs achieves a great cleaning result.

---

#### Potential marks

Limescale and water marks	Clean the hob as soon as it has cooled down. You can use a cleaning agent suitable for glass-ceramic hobs.*
Sugar, rice starch or plastic	Clean immediately. Use a glass scraper. Caution: Risk of burns.*

\* Then clean with a damp dish cloth and dry with a cloth or towel.

**Note:** Do not use any cleaning agents while the hob is still hot. This may mark the surface. Make sure that any residue left by cleaning agents is removed.

## Hob surround

To prevent damage to the hob surround, observe the following instructions:

- Only use warm soapy water
- Wash new dish cloths thoroughly before use.
- Do not use harsh or abrasive cleaning agents.
- Do not use a glass scraper or sharp objects.

## Twist knob

The twist knob is best cleaned using lukewarm soapy water. Do not use harsh or abrasive cleaning agents. Do not clean the twist knob in the dishwasher or using rinsing water. This may damage it.

---

## Frequently Asked Questions (FAQ)

---

---

### Using the appliance

---

#### Why can't I switch on the cooktop and why is the child lock symbol lit?

The child lock is activated. Place the twist knob on the twistpad.

You can find information about this function in section → *"Childproof lock"*

---

#### Why can I hear an audible signal?

Remove any liquid or food remains from the control panel. Remove any objects from the control panel.

You can find instructions on how to deactivate the audible signal in the section on → *"Basic settings"*

---

#### Why can the cooking assistance functions not be activated?

The appliance's maximum power consumption is achieved or the power manager function has been activated. Switch off or reduce the power levels of the active hotplates.

You can find further information about this function in section → *"Power manager"*

---

---

### Noises

---

#### Why I can hear noises while I'm cooking?

Noises may be generated while using the hob depending on the base material of the cookware. These noises are a normal part of induction technology. They do not indicate a defect.

---

#### Possible noises:

##### **A low humming noise like the one a transformer makes:**

Occurs when cooking at a high heat setting. The noise disappears or becomes quieter when the heat setting is reduced.

---

##### **Low whistling noise:**

Occurs when the cookware is empty. This noise disappears when water or food is added to the cookware.

---

##### **Crackling:**

Occurs when using cookware made from different layers of material or when using cookware of different sizes and different materials at the same time. The loudness of the noise can vary depending on the quantity of food being cooked or the cooking method.

---

##### **High-pitched whistling noises:**

Can occur when two hotplates are used at the highest heat setting at the same time. The whistling noises disappear or become quieter when the heat setting is reduced.

---

##### **Fan noise:**

The hob is equipped with a fan that switches on automatically at high temperatures. The fan may continue to run even after you have switched off the hob if the temperature detected is still too high.

---

---

**Cookware**

---

**Which types of cookware can be used with the induction hob?**

You can find information on which types of cookware can be used with the induction hob in the section entitled → *"Induction cooking"*.

---

**Why is the hotplate not heating up and why is the heat setting flashing?**

The hotplate on which the cookware is standing is not switched on.

Check that you have switched on the correct hotplate.

---

The cookware is too small for the hotplate that is switched on or it is not suitable for induction cooking.

Check that the cookware is suitable for induction cooking and that it is placed on the hotplate that most closely matches its size. You can find information on the type, size and positioning of cookware in the sections entitled → *"Induction cooking"*, → *"Flex function"* and → *"Transfer function"*

---

**Why is it taking so long for the cookware to heat up or why is it not heating up sufficiently despite being at a high heat setting?**

The cookware is too small for the hotplate that is switched on or it is not suitable for induction cooking.

Check that the cookware is suitable for induction cooking and that it is placed on the hotplate that most closely matches its size. You can find information on the type, size and positioning of cookware in the sections entitled → *"Induction cooking"*, → *"Flex function"* and → *"Transfer function"*

---

---

**Cleaning**

---

**How do I clean the hob?**

Using a special glass-ceramic cleaning agent produces the best results. We advise against using harsh or abrasive cleaning agents, dishwasher detergent (concentrated) or scouring pads.

You can find more information on cleaning and caring for your hob in the section on → *"Cleaning"*

---

## Trouble shooting

Usually, faults are small matters that are easy to eliminate. Please read the information in the table before calling the after-sales service.

Display	Possible cause	Solution
None	The power supply has been disconnected.  The appliance has not been connected as shown in the circuit diagram.  Electronics fault.	Use other electrical appliances to check whether a short circuit has occurred in the power supply.  Make sure that the appliance has been connected as shown in the circuit diagram.  If you are unable to rectify the fault, inform the technical after-sales service.
The indicators are flashing.	The control panel is damp or there is something on it.	Dry the control panel or remove the object.
<i>F2/E8207</i>	The electronics have overheated and have switched off the affected cooking zone.	Wait until the electronics have cooled down sufficiently. Then touch any symbol on the hob.
<i>F4/E8208</i>	The electronics have overheated and all the cooking zones have been switched off.	
<i>F5</i> + heat setting and signal tone	There is hot cookware near the control panel. There is a risk that the electronics will overheat.	Remove the cookware that is causing the problem. The fault display goes out shortly afterwards. You can continue the cooking process.
<i>F5</i> and signal tone	There is hot cookware near the control panel. The cooking zone has been switched off to protect the electronics.	Remove the pan. Wait a few seconds. Touch any touch control. When the fault display goes out, you can continue cooking.
<i>F1/F6</i>	The cooking zone has overheated and has been switched off to protect the work surface.	Allow the electronics to cool down sufficiently and switch the cooking zone on again.
<i>F0</i>	The transfer settings function cannot be activated.	Confirm the fault display by touching any sensor. You can cook as usual without using the settings transfer function. Inform the technical after-sales service.
<i>F8</i>	The cooking zone has been operating continuously for an extended period.	The automatic safety cut-out function has been activated. See section
<i>F9</i>	The FlexPlus cooking zone will not activate.	Touch any touch control to check the fault code. You can use the remaining hotplates to cook as usual. Contact the technical after-sales service.
<i>E8202</i>	The temperature sensor has overheated and the cooking zone has been switched off.	Wait until the cooking sensor has cooled down sufficiently before activating the function again.
<i>E8203</i>	The temperature sensor has overheated and all the cooking zones have been switched off.	When you are not using the temperature sensor, remove this from the cookware and store it far away from the cooking zones or heat sources. Switch the cooking zones back on.
<i>E8204</i>	The battery in the temperature sensor is dead.	Replace the 3 V CR2032 battery. See the section entitled "Changing the battery".
<i>E8205</i>	The temperature sensor is no longer connected.	Switch the function off and then on again.
<i>E8206</i>	The temperature sensor is broken/faulty.	Inform the technical after-sales service.
The temperature sensor indicator does not light up.	The temperature sensor does not respond and the indicator is not lit up.	Replace the 3 V CR2032 battery. See the section entitled "Changing the battery".  If this does not solve the problem, press and hold the symbol on the temperature sensor for eight seconds and then reconnect the temperature sensor to the hob.  If the problem still persists, contact the technical after-sales service.

Do not place hot cookware on the control panel.



Display	Possible cause	Solution
The indicator on the temperature sensor flashes twice.	The battery in the temperature sensor has almost run out. You may be interrupted the next time you cook by the battery running out.	Replace the 3 V CR2032 battery. See the section entitled "Changing the battery".
The indicator on the temperature sensor flashes three times.	The temperature sensor is no longer connected.	Press and hold the symbol on the temperature sensor for eight seconds and then reconnect the temperature sensor to the hob.
<i>E9000</i> <i>E90 10</i>	The operating voltage is incorrect and outside of the normal operating range.	Contact your electricity supplier.
<i>U400</i>	The hob is not connected correctly.	Disconnect the hob from the mains. Make sure that it has been connected as shown in the circuit diagram.
<i>dE</i>	Demo mode is activated.	Disconnect the hob from the mains. Wait 30 seconds and then reconnect. Touch any touch control within the next three minutes. Demo mode is switched off.

Do not place hot cookware on the control panel.

### Notes

- If *E* appears on the display, press and hold the button for the relevant cooking zone in order to read the fault code.
- If the fault code is not listed in the table, disconnect the hob from the mains power supply and wait 30 seconds before reconnecting it. If this code is displayed again, contact the technical after-sales service and specify which fault code has appeared.
- If a fault occurs, the appliance will not switch to standby mode.

---

## Customer service

---

Our after-sales service is there for you if your appliance needs to be repaired. We will always find an appropriate solution, also in order to avoid after-sales personnel having to make unnecessary visits.

### Product number (E no.) and production number (FD no.)

Always quote the E number (product number) and FD number (production number) of your appliance when contacting the after-sales service.

The rating plate bearing these numbers can be found:

- On the appliance certificate.
- On the underside of the hob.

The product number (E no.) can be found on the glass-ceramic hob. You can check the after-sales service index (KI) and production number (FD no.) by going to the basic settings. Refer to the section entitled → "*Basic settings*" to find out how to do this.

Please note that a visit from an after-sales service engineer is not free of charge in the event that the appliance has been misused, even during the warranty period.

Please find the contact data of all countries in the enclosed customer service list.

#### To book an engineer visit and product advice

**GB** 0344 892 8988  
Calls charged at local or mobile rate.

**IE** 01450 2655  
0.03 € per minute at peak.  
Off peak 0.0088 € per minute.

**AU** 1300 368 339

**NZ** 09 477 0492

Trust the expertise of the manufacturer, and rest assured that the repair will be carried out by trained service technicians using original spare parts for your domestic appliance.



**Gaggenau Hausgeräte GmbH**  
Carl-Wery-Straße 34  
81739 München  
GERMANY  
www.gaggenau.com

Valid within Great Britain:

Imported to Great Britain by

BSH Home Appliances Ltd.  
Grand Union House  
Old Wolverton Road  
Wolverton, Milton Keynes  
MK12 5PT  
United Kingdom

9001436717 (981025)  
en

**GAGGENAU**

