

VI 462 103

VI 462 113

Hob

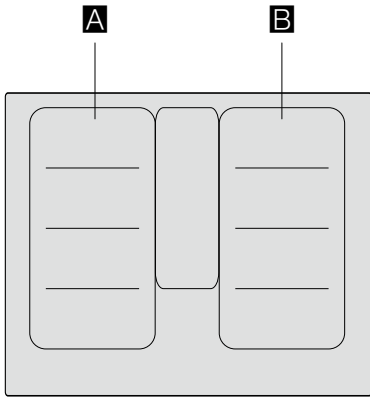

		l_2^*	b^*
A / B		2.200 W	3.700 W
		3.300 W	3.700 W
		2.600 W	3.700 W
		3.300 W	3.700 W

* IEC 60335-2-6

Table of contents

Intended use	4	Locking the control panel for cleaning	20
Important safety information	5	Automatic safety switch-off function	20
Causes of damage	7	Basic settings	21
Overview	7	To access the basic settings:	21
Environmental protection	8	Home Connect	22
Energy-saving advice	8	Home Connect settings menu	22
Environmentally-friendly disposal	8	Setting up	23
Induction cooking	8	Switching WiFi off/on	24
Advantages of induction cooking	8	Resetting connection	24
Cookware	8	Software update	25
Getting to know your appliance	10	Remote diagnostics	25
The control panel	10	About data protection	25
Control knob	11	Declaration of Conformity	25
The hotplates	11	Connecting an extractor hood	26
Residual heat indicator	11	Connecting via the home network	26
Optional accessories	11	Connecting directly	27
Operating the appliance	12	Control the hood via the hob	27
Applying hotplate settings	12	Cookware test	28
Chef's recommendations	12	Cleaning	29
Flexible cooking zone	13	Hob	29
Advice on using cookware	13	Hob surround	29
As two independent hotplates	13	Control knob	29
As a single hotplate	14	Frequently Asked Questions (FAQ)	30
FlexPlus cooking zone	14	Trouble shooting	31
Notes regarding cookware	14	Demo mode	32
Activation	15	Customer service	32
Deactivating	15	E number and FD number	32
Timer functions	15		
The kitchen timer	15		
Stopwatch function	16		
PowerBoost function	16		
Activating	16		
Deactivating	16		
Frying sensor	17		
Advantages when frying	17		
Frying pans for the frying sensor	17		
Temperature settings	17		
Table	18		
Setting procedure	20		

Additional information on products, accessories, replacement parts and services can be found at www.gaggenau.com and in the online shop www.gaggenau.com/zz/store

Intended use

Read these instructions carefully. Please keep the instruction and installation manual, as well as the appliance certificate, in a safe place for later use or for subsequent owners.

Check the appliance after removing it from the packaging. If it has suffered any damage in transport, do not connect the appliance, contact the Technical Assistance Service and provide written notification of the damage caused, otherwise you will lose your right to any type of compensation.

Only a licensed professional may connect appliances without plugs. Damage caused by incorrect connection is not covered under warranty.

This appliance must be installed according to the installation instructions included.

This appliance is intended for private domestic use and the household environment only. The appliance must only be used for the preparation of food and beverages. The cooking process must be supervised. A short cooking process must be supervised without interruption. Only use the appliance in enclosed spaces.

This appliance is intended for use up to a maximum height of 4000 metres above sea level.

Do not use covers. These can cause accidents, for example due to overheating, catching fire or materials shattering.

Only use safety devices or child protection grilles approved by ourselves. Unsuitable safety devices or child protection grilles may result in accidents.

This appliance is not intended for operation with an external clock timer or a remote control.

This appliance may be used by children over the age of 8 years old and by persons with reduced physical, sensory or mental capabilities or by persons with a lack of experience or knowledge if they are supervised or are instructed by a person responsible for their safety how to use the appliance safely and have understood the associated hazards.

Children must not play with, on, or around the appliance. Children must not clean the appliance or carry out general maintenance unless they are at least 15 years old and are being supervised.

Keep children below the age of 8 years old at a safe distance from the appliance and power cable.

If you wear an active implantable medical device (e.g. a pacemaker or defibrillator), check with your doctor that it complies with Council Directive 90/385/EEC of 20th June 1990, DIN EN 45502-2-1 and DIN EN 45502-2-2, and that it has been chosen, implanted and programmed in accordance with VDE-AR-E 2750-10. If these conditions are satisfied, and if, in addition, non-metal cooking utensils and cookware with non-metal handles are used, it is safe to use this induction hob as intended.

⚠ Important safety information

⚠ Warning – Danger of suffocation!

Packaging material is dangerous to children. Never allow children to play with packaging material.

⚠ Warning – Risk of fire!

- Hot oil and fat can ignite very quickly. Never leave hot fat or oil unattended. Never use water to put out burning oil or fat. Switch off the hotplate. Extinguish flames carefully using a lid, fire blanket or something similar.
- The hotplates become very hot. Never place combustible items on the hob. Never place objects on the hob.
- The appliance gets hot. Do not keep combustible objects or aerosol cans in drawers directly underneath the hob.
- The hob switches off automatically and can no longer be operated. It may switch on unintentionally at a later point. Switch off the circuit breaker in the fuse box. Contact the after-sales service.
- Do not use hob covers here. They can cause accidents, for example due to overheating, catching fire or materials shattering.

⚠ Warning – Risk of burns!

- The hotplates and surrounding area (particularly the hob surround, if fitted) become very hot. Never touch the hot surfaces. Keep children at a safe distance.
- The hotplate heats up but the display does not work. Switch off the circuit breaker in the fuse box. Contact the after-sales service.
- Metal objects on the hob quickly become very hot. Never place metal objects (such as knives, forks, spoons and lids) on the hob.

- Always switch the hob off using the controls after each use. Do not wait until the hob turns off automatically after the pan is removed.

⚠ Warning – Risk of electric shock!

- Incorrect repairs are dangerous. Repairs may only be carried out and damaged power cables replaced by one of our trained after-sales technicians. If the appliance is defective, unplug the appliance from the mains or switch off the circuit breaker in the fuse box. Contact the after-sales service.
- Do not use any high-pressure cleaners or steam cleaners, which can result in an electric shock.
- A defective appliance may cause electric shock. Never switch on a defective appliance. Unplug the appliance from the mains or switch off the circuit breaker in the fuse box. Contact the after-sales service.
- Cracks or fractures in the glass ceramic may cause electric shocks. Switch off the circuit breaker in the fuse box. Contact the after-sales service.

⚠ Warning – Risk of fault!

A fan is located on the underside of this hob. If a drawer is located on the underside of the hob, do not store any small or sharp objects, paper or tea towels in it. These may be sucked in and damage the fan or impair the cooling.

There must be a clearance of at least 2 cm between the contents of the drawer and the fan entry point.

⚠ Warning – Risk of injury!

- When cooking in a bain marie, the hob and cooking container could shatter due to overheating. The cooking container in the bain marie must not directly touch the bottom of the water-filled pot. Only use heat-resistant cookware.
- Saucepans may suddenly jump due to liquid between the pan base and the hotplate. Always keep the hotplate and saucepan bases dry.

Causes of damage

Caution!

- Rough pan bases may scratch the hob.
- Avoid leaving empty pots and pans on the hotplate. Doing so may cause damage.
- Do not place hot pans on the control panel, the indicator area, or the hob frame. Doing so may cause damage.
- Hard or pointed objects dropped on the hob may damage it.
- Aluminium foil and plastic containers will melt if placed on the hotplate while it is hot. The use of laminated sheeting is not recommended on the hob.

Overview

The table below lists the commonest kinds of damage:

Damage	Cause	Remedy
Stains	Food boiling over	Remove any food that has boiled over immediately with a glass scraper
	Unsuitable cleaning agents	Only use cleaning agents that are suitable for this type of hob
Scratches	Salt, sugar and sand	Do not use the hob as a work surface or storage space
	Rough pan bases can scratch the hob	Inspect the cookware
Discolouration	Unsuitable cleaning agents	Only use cleaning agents that are suitable for this type of hob
	Wear caused by cookware	Lift pots and pans when moving them.
Blistering	Sugar, food with a high sugar content	Remove any food that has boiled over immediately with a glass scraper

Environmental protection

In this section, you can find information about saving energy and disposing of the appliance.

Energy-saving advice

- Always use the correct lid for each pan. Cooking without a lid uses a lot more energy. Use a glass lid to provide visibility and avoid having to lift the lid.
- Use pans with flat bases. Bases that are not flat use a lot more energy.
- The diameter of the pan base must match the size of the hotplate. Please note: pan manufacturers usually provide the diameter for the top of the pan, which is usually larger than the diameter of the pan base.
- Use a small pan for small amounts of food. A large pan which is not full uses a lot of energy.
- Use little water when cooking. This saves energy and preserves all the vitamins and minerals in vegetables.
- Select the lowest power level to maintain cooking. If the power level is too high, energy is wasted.

Environmentally-friendly disposal

Dispose of packaging in an environmentally-friendly manner.



This appliance is labelled in accordance with European Directive 2012/19/EU concerning used electrical and electronic appliances (waste electrical and electronic equipment - WEEE). The guideline determines the framework for the return and recycling of used appliances as applicable throughout the EU.

Induction cooking

Advantages of induction cooking

Induction cooking is very different from traditional cooking methods, as heat builds up directly in the item of cookware. This offers numerous advantages:

- Saves time when boiling and frying.
- Saves energy.
- Easier to care for and clean. Spilled food does not burn on as quickly.
- Heat control and safety – the hob increases or decreases the heat supply as soon as the user changes the setting. The induction hotplate stops the heat supply as soon as the cookware is removed from the hotplate, without having to switch it off first.

Cookware

Only use ferromagnetic cookware for induction cooking, such as:

- Cookware made from enamelled steel
- Cookware made from cast iron
- Special induction-compatible cookware made from stainless steel.

To check whether your cookware is suitable for induction cooking, refer to the section entitled → "Cookware test".

To achieve a good cooking result, the ferromagnetic area on the base of the pan should match the size of the hotplate. If a hotplate does not detect an item of cookware, try placing it on another hotplate with a smaller diameter.

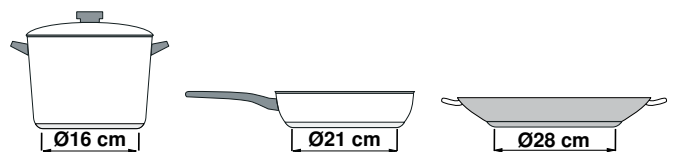

If the only hotplate being used is the Flex cooking zone, larger cookware that is particularly suited to this zone can be used. You can find further information on positioning the cookware in the section entitled → "Flexible cooking zone".



Some induction cookware does not have a fully ferromagnetic base:

- If the base of the cookware is only partially ferromagnetic, only the area that is ferromagnetic will heat up. This may mean that heat will not be distributed evenly. The non-ferromagnetic area may not heat up to a sufficient temperature for cooking.

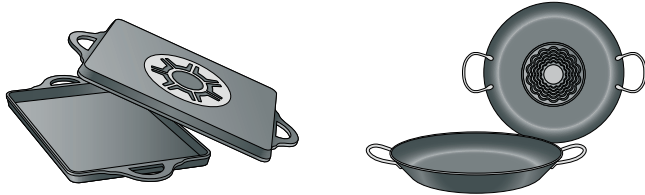

- The ferromagnetic area will also be reduced if the material from which the base of the cookware is made contains aluminium, for example. This may mean that the cookware will not become sufficiently hot or even that it will not be detected.

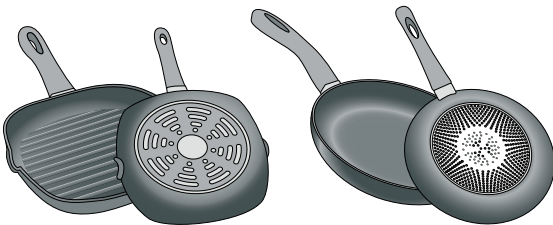

Unsuitable pans

Never use diffuser hobs or pans made from:

- common thin steel
- glass
- earthenware
- copper
- aluminium

Properties of the base of the cookware

The material(s) from which the base of the cookware is made can affect the cooking result. Using pots and pans made from materials that distribute heat evenly through them, such as stainless-steel pans with a three-layer base, saves time and energy.

Use cookware with a flat base; if the base of the cookware is uneven, this may impair the heat supply.

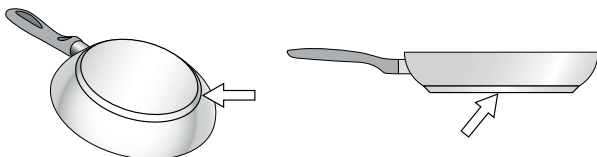

No cookware on hotplate/cookware of an unsuitable size

If no cookware is placed on the selected hotplate, if the cookware is made of an unsuitable material or if it is not the right size for the hotplate, the hotplate indicator will start to flash. To stop the indicator flashing, place suitable cookware on the hotplate. If it is left flashing for more than 9 minutes, the hotplate will automatically switch off.

Empty pans or those with a thin base

Do not heat empty pans, nor use pans with a thin base. The hob is equipped with an internal safety system. However, an empty pan may heat up so quickly that the "automatic switch off" function may not have time to react and the pan may reach very high temperatures. The base of the pan could melt and damage the glass on the hob. In this case, do not touch the pan and switch the hotplate off. If it fails to work after it has cooled down, please contact the Technical Assistance Service.

Pan detection

Each hotplate has a lower limit for pan detection. This depends on the diameter of the ferromagnetic area of the cookware and the material from which its base is made. For this reason, you should always use the hotplate that best matches the diameter of the base of the pan.

Getting to know your appliance

You can find information on the dimensions and power of the hotplates in → *Page 2*

Note: Depending on the appliance model, individual details and colours may differ.

This appliance can be networked and controlled remotely using a mobile device. To do this, first connect the appliance to your home network. → *"Home Connect" on page 22*

The control panel

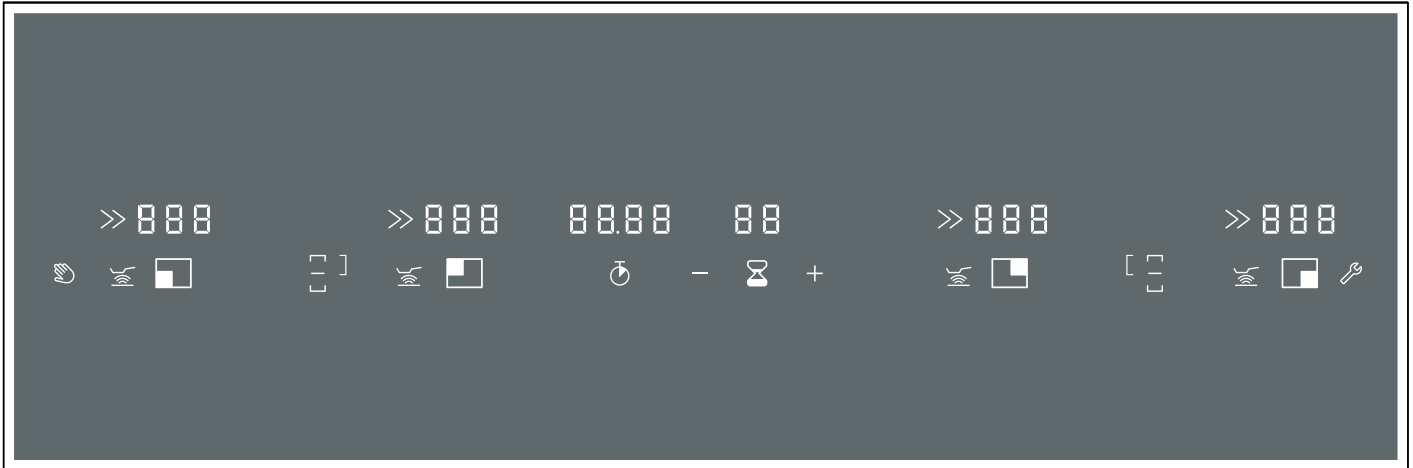

Touch controls

	Locking the control panel for cleaning
	Frying sensor
	Basic settings
	Select settings
	Stopwatch
	Timer

Displays

	Operating status
	Heat settings
	Residual heat
	Short-term timer
	Stopwatch
	Hotplate
	PowerBoost function
	FlexZone activated
	FlexZone deactivated
	FlexPlus cooking zone
	Frying sensor
	Frying sensor temperature indicator
	Home network

Notes

- The corresponding symbols for the controls will light up, depending on whether they are available. The controls that are available will be lit white. When a function is selected, they turn orange.
- Always keep the control panel clean and dry. Moisture reduces their effectiveness.
- Do not place hot cookware anywhere other than the front hotplate, and never on the control panel. There is a risk that the control panel's electronics will overheat.

Controls

When the hob heats up, the symbols for the controls available at this time light up.

Touch a symbol to activate the function it represents. An audible confirmation signal will sound.

Control knob

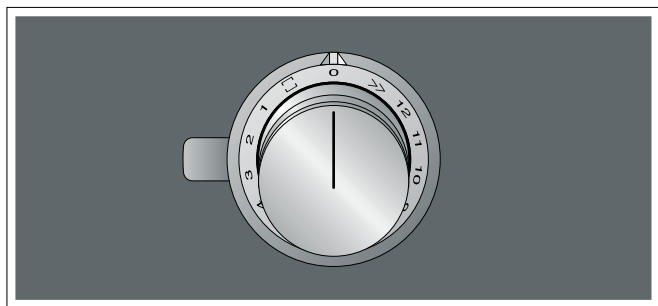

You can use the control knobs to select the heat setting, the PowerBoost function and the Flex cooking zone.

1	Lowest heat setting
12	Highest heat setting
>>	PowerBoost function
☐	Flex cooking zone activated

The control knobs have an illuminated ring with an illuminated symbol for each function. The illuminated ring changes colour when particular functions or processes are activated.

Display	Meaning
○ Off	Appliance OFF
● Lights up orange	Appliance ON
☀ Flashing orange	Appliance OFF Residual heat indicator
● Lights up blue	Home Connect
☀ Flashing blue	Home Connect
☀ Flashing orange and white alternately	Safety switch-off function, power failure
☀ Flashing yellow and magenta alternately	Appliance fault Call the after-sales service
● Lights up green for a few seconds, then turns yellow	Appliance initialised, only after initial connection or power failure

The hotplates

Hotplate		
☐	Single-circuit hotplate	Use cookware that is a suitable size
☐	FlexZone	See section → " <i>Flexible cooking zone</i> ".
☐ / ☐	FlexPlus cooking zone	The FlexPlus cooking zone always switches on in conjunction with one of the FlexZones. See section → " <i>FlexPlus cooking zone</i> ".

Only use cookware that is suitable for use with induction hobs – see section entitled → "*Induction cooking*".

Residual heat indicator

The hob has a residual heat indicator for each hotplate. This indicates that the hotplate is still hot. Do not touch the hotplate while the residual heat indicator is still lit or immediately after it goes out.

The following will be shown depending on the amount of residual heat:

- *H*: High temperature
- *h*: Low temperature

and the illuminated ring around the control knob will flash.

If the cookware is removed from the hotplate while cooking is in progress, the heat setting indicator will flash and the control knob will be lit orange.

Turn the control knob to position 0.

If the hotplate is switched off, the residual heat indicator will be lit and the illuminated ring around the control knob will flash. Even after the hob has been switched off, the residual heat indicator will remain lit as long as the hotplate is still warm.

Optional accessories

You can purchase the following accessories from your specialist retailer:

CA 051 300 Multilayer Teppanyaki plate

CA 052 300 Cast aluminium grill plate

Only use the accessories as specified. The manufacturer accepts no liability if these accessories are used incorrectly.

Operating the appliance

This chapter explains how to set a hotplate. The table shows heat settings and cooking times for various meals.

Applying hotplate settings

Use the control knob to select the heat setting you require.

0	Hotplate off.
Heat setting 1	Lowest setting
Heat setting 12	Highest setting

Note: Only use cookware with a suitable diameter. The base of the cookware should not protrude over the marked cooking zones.

Notes

- To protect the fragile parts of your appliance from overheating and electrical overloading, the hob may temporarily reduce the power.
- In order to prevent the appliance from producing excess noise, the hob may temporarily reduce the power.

Selecting a heat setting

Push in the control knob and turn it to the heat setting you require.

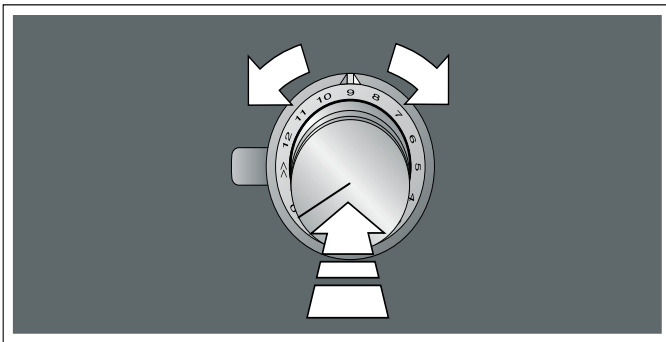

The selected heat setting will be lit on the hotplate display. The illuminated ring around the control knob will be lit.

Switching off a hotplate

Turn the control knob to position 0.

The residual heat indicator will be lit and the illuminated ring around the control knob will flash until the hotplate has cooled down.

Note: If there is no cookware on the hotplate or if the cookware is not detected, the selected heat setting will flash and the illuminated ring around the control knob will be lit orange. After approximately 9 minutes, the hotplate will switch off.

In this case, the illuminated ring around the control knob will flash. Turn the control knob back to position 0; the illuminated ring will stop flashing.

Chef's recommendations

Recommendations

- Stir occasionally when heating up purees, creamy soups and thick sauces.
- For preheating, select a heat setting between 10 and 12.
- When cooking with the lid on, reduce the heat as soon as you see steam escaping. The cooking result is not affected by the steam escaping.
- After cooking, keep the lid on the cookware until you serve the food.
- To cook with the pressure cooker, follow the manufacturer's instructions.
- Do not cook food for too long, otherwise nutrients will be lost. The short-term timer can be used to set the optimum cooking time.
- For a healthier result, ensure that the oil does not smoke.
- To brown food, fry it in small batches.
- Cookware may reach high temperatures while the food is cooking. Use oven gloves.
- You can find recommendations for energy-efficient cooking in the section entitled → "Energy-saving advice" on page 8.

Cooking table

The table shows which heat setting is suitable for each type of food. The cooking time may vary depending on the type, weight, thickness and quality of the food.

Heat setting	Cooking methods	Examples
11 - 12	Parboiling	Water
	Searing	Meat
	Heating	Fat/oil, liquids
	Bringing to the boil	Soups, sauces
	Blanching	Vegetables
7 - 10	Frying	Meat, potatoes
6 - 8	Frying	Fish
8 - 9	Baking	Flour-based and/or egg-based dishes, e.g. pancakes
	Simmering in an uncovered dish	Dough-based foods, liquids
7 - 8	Browning	Flour, onions
	Toasting	Almonds, breadcrumbs
	Rendering	Bacon
	Reducing	Stocks, sauces
6 - 7	Poaching in an uncovered dish	Dumplings, soup vegetables, soup meat, poached eggs
5 - 6	Poaching in an uncovered dish	Boiled sausages
6 - 7	Steaming	Vegetables, potatoes, fish
	Stewing	Vegetables, fruit, fish
	Braising	Roulade, roasts, vegetables
3 - 4	Braising	Goulash
4 - 5	Cooking with the lid on	Soups, sauces
3 - 4	Defrosting	Frozen products
	Soaking	Rice, pulses, vegetables
	Thickening	Egg-based dishes, e.g. omelette
1 - 2	Heating/keeping warm	Soup, vegetables in sauce
1	Heating/keeping warm	Stews
	Melting	Butter, chocolate

Flexible cooking zone

You can use each flex zone as a single hotplate or as two independent hotplates, as required.

It consists of four inductors that work independently of each other. If using the flexible cooking zone, only the area that is covered by cookware is activated.

Note: Only use cookware with a suitable diameter. The base of the cookware should not protrude over the marked cooking zones.

Advice on using cookware

To ensure that the cookware is detected and heat is distributed evenly, correctly centre the cookware:

As a single hotplate

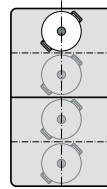

Diameter smaller than or equal to 13 cm
Place the cookware on one of the four positions that can be seen in the illustration.

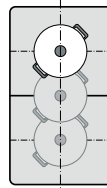

Diameter greater than 13 cm
Place the cookware on one of the three positions that can be seen in the illustration.

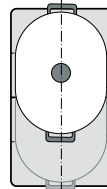

If the cookware takes up more than one hotplate, place it starting on the upper or lower edge of the flexible cooking zone.

As two independent hotplates

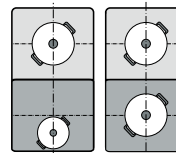

The front and rear hotplates each have two inductors and can be used independently of each other. Select the required heat setting for each of the hotplates. Use only one item of cookware on each hotplate.

As two independent hotplates

The flexible cooking zone is used like two independent hotplates.



Activating

See section → "Operating the appliance".

As a single hotplate

Using the entire cooking zone by connecting both hotplates.

Linking the two hotplates

- 1 Set down the cookware. Turn one of the control knobs to position .
- 2 Use the other control knob to select the heat setting. The  indicator will be lit. The heat setting will be lit on the displays for the two hotplates.

The Flex cooking zone has now been activated.

Changing the heat setting

To alter the heat setting, use the same control knob you used to select the original heat setting.

Adding new cookware

Set down the new cookware. Turn the control knob that was used to select the Flex cooking zone to position 0 and then back to position .

The cookware will be detected and the heat setting that was previously selected will be retained.

Note: If the cookware is moved to the hotplate being used or lifted up, the hotplate begins an automatic search and the heat setting selected previously is retained.

Unlinking the two hotplates

Turn the control knob that was used to select the Flex cooking zone to position 0. The  indicator will be lit.

The Flex cooking zone has now been deactivated. The two hotplates will now function independently.

Note: If you switch the hob off and then subsequently switch it on again, the flexible cooking zone is converted back to two independent hotplates.

FlexPlus cooking zone

The hob has a FlexPlus cooking zone which is located between the two flexible cooking zones and which switches on in conjunction with the right- or left-hand flexible cooking zone. This means that larger cooking vessels can be used and better cooking results can be achieved.

The FlexPlus cooking zone always switches on in conjunction with one of the two flexible cooking zones. It is not possible to activate these cooking zones independently.

Notes regarding cookware

The cookware should be positioned centrally for good thermal detection and distribution.

The cookware should cover the side hotplate and the FlexPlus cooking zone.

Depending on the size of the cookware, the flexible cooking zone can be activated as two independent hotplates or as one hotplate:

Set down the cookware

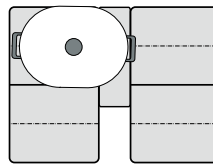

Oblong cookware
Activate the flexible cooking zone as two independent hotplates or as one hotplate.

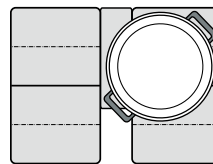

Large round cookware
Activate the flexible cooking zone as a single hotplate.

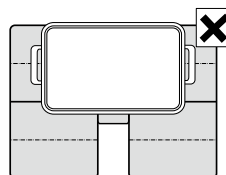

The vessel must not cover the two side cooking zones and the FlexPlus cooking zone at the same time.

Activation

- 1 Set down the cookware on the hotplate and make sure that it also covers the FlexPlus cooking zone.
- 2 Select the hotplate and the required heat setting. The hotplate and FlexPlus cooking zone indicators light up.

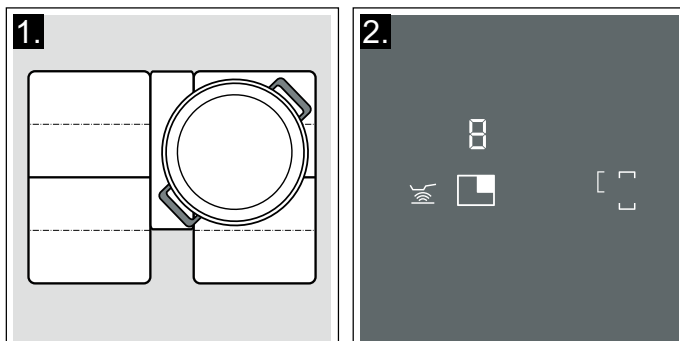

The flexible cooking zone is activated.

Note: If the two cooking zones next to the FlexPlus cooking zone are covered by cookware, the FlexPlus cooking zone indicator may flash.

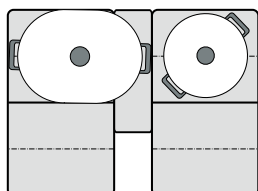

To link the FlexPlus cooking zone to the corresponding cooking zone, lift the cookware and set it back down on the cooking zone before selecting a heat setting.

Deactivating

Remove the cookware from the hotplate. The displays go out.

This deactivates the FlexPlus cooking zone.

Timer functions

Your hob has two timer functions:

- Short-term timer
- Stopwatch

The kitchen timer

You can use the kitchen timer to set a time of up to 99 minutes.

This functions independently from the hotplates and from other settings. This function does not automatically switch off a hotplate.

Setting procedure

- 1 Touch the ⌚ symbol; **00** and the **-** and **+** symbols will light up on the short-term timer display.
- 2 Set the required cooking time using the **-** and **+** symbols within the next 10 seconds.

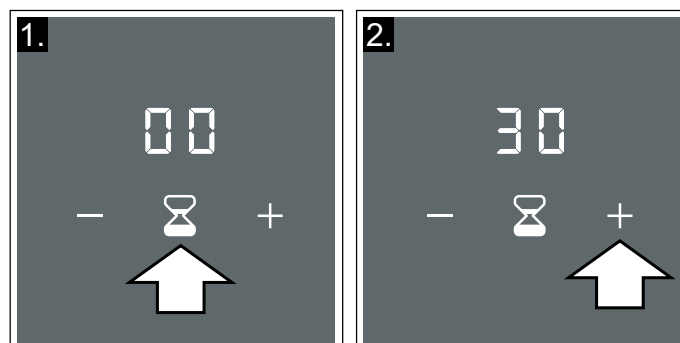

Note: If you press and hold the **-** or **+** symbol, you can set the cooking time more quickly.

- 3 Touch the ⌚ symbol again to confirm the selected cooking time. The time will now start to elapse.

Note: If you do not confirm the setting within 10 seconds, the short-term timer will start automatically.

Changing or cancelling the cooking time

- 1 Touch the ⌚ symbol.
- 2 Alter the cooking time using the **-** and **+** symbols or set it to **00**.
- 3 Touch the ⌚ symbol to confirm the cooking time.

Once the cooking time has elapsed

An audible signal will sound. **00** will flash on the short-term timer display.



Touch the ⌚ symbol; the indicators will go out and the signal tone will cease.

Stopwatch function

The stopwatch shows the cooking time that has elapsed so far in minutes and seconds (mm.ss). The maximum duration is 99 minutes and 59 seconds (99.59). If this value is reached, the display starts again at 00.00.

The stopwatch works independently of the hotplates and other settings. This function does not automatically switch off a hotplate.

Activating

- 1 Select a heat setting. The  indicator will be lit.
- 2 Touch the  symbol. **00.00** will be lit on the stopwatch display.

The time will now start to elapse.

Stopping the stopwatch

Touch the  symbol to stop the stopwatch. The stopwatch indicators will remain lit.

Touch the  symbol again to restart the stopwatch.

Deactivating

Press and hold the  symbol for a few seconds. This will stop the stopwatch, and the stopwatch indicators will go out.

This function has now been deactivated.

PowerBoost function

The PowerBoost function enables you to heat up large volumes of water faster than when using heat setting **12**.

This function is available for all hotplates, provided the other hotplate in the same group is not in use. Otherwise, **P** and **12** will flash on the display for the selected hotplate; the **12** heat setting will then be set automatically without activating this function. In this case, turn the control knob to position 0.

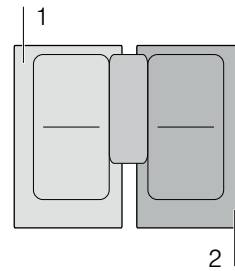

Note: The PowerBoost function can also be activated in the flexible area if the cooking zone is being used as a single hotplate.

Activating

Push in the control knob and turn it to position **>>**. The **P** and **>>** indicators will light up.

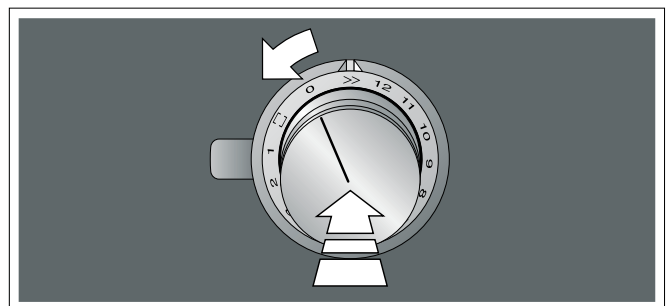

The function has now been activated.

Deactivating

Turn the control knob to the heat setting you require. **P** and **>>** will go out and the heat setting you have selected will be lit.

This function has now been deactivated.

Note: In certain circumstances, the PowerBoost function may switch itself off automatically in order to protect the electronic elements inside the hob. In this case, heat setting **12** will automatically be set. Turn the control knob to position 0 or whichever heat setting you require.

Frying sensor

This function maintains the appropriate temperature in the frying pan when you are frying food.

Advantages when frying

- The hotplate only heats up if this is required to maintain the temperature. This saves energy and prevents the oil or fat from overheating.
- The frying function reports when the empty frying pan has reached the optimum temperature for adding oil and then for adding the food.

Notes

- Do not place a lid on the pan. Otherwise, the function does not activate correctly. You can use a splash guard to prevent splashes of grease.
- Use suitable oil or fat for frying. If butter, margarine, extra virgin olive oil or lard is used, set heat setting 1 or 2.
- Never leave a frying pan, with or without food, unattended when it is being heated.
- If the hotplate is a higher temperature than the cookware or vice versa, the frying sensor will not be activated correctly.

Frying pans for the frying sensor

Frying pans specifically suited to use with the frying sensor are available. This optional accessory can be purchased separately from specialist retailers or through our technical after-sales service. Always quote the relevant reference number.

- GP900001 15 cm frying pan.
- GP900002 19 cm frying pan.
- GP900003 21 cm frying pan.
- GP900004 28 cm frying pan. Only recommended for the FlexPlus cooking zone.

These frying pans have a non-stick coating so that you require only a small amount of oil to fry food.

Notes

- The frying sensor has been configured specifically for this type of frying pan.
- Ensure that the diameter of the base of the frying pan corresponds to the size of the hotplate. Place the frying pan in the centre of the hotplate.
- The frying sensor may not activate on the Flex cooking zone if the frying pan does not match the size of the hotplate or if it is positioned incorrectly. See section → "*Flexible cooking zone*".
- Other types of frying pan may overheat. They may reach a temperature above or below the selected temperature setting. Select the lowest temperature setting to begin with and change it if necessary.

Temperature settings

Temperature setting	Suitable for
1 Very low	Preparing and reducing sauces, stewing vegetables and frying food in extra virgin olive oil, butter or margarine.
2 Low	Frying food in extra virgin olive oil, butter or margarine, e.g. omelettes.
3 Low - medium	Frying fish and thick food such as meatballs and sausages.
4 Medium - high	Frying steaks (medium or well done), frozen breaded products, thin food such as escalopes, strips of meat and vegetables.
5 High	Frying food at high temperatures, e.g. rare steaks (bloody), potato fritters and fried potatoes.

Table

The table shows which heat setting is suitable for each type of food. The roasting time may vary depending on the type, weight, size and quality of the food.

Preheat the empty pan; add oil and food after the acoustic signal has sounded.

The set heat setting varies depending on the frying pan that is used.

	Tempera- ture setting	Total frying time after the signal sounds (mins.)
Meat		
Escalope, plain or breaded	4	6 - 10
Fillet	4	6 - 10
Chops*	3	10 - 15
Cordon bleu, Viennese Schnitzel*	4	10 - 15
Steak, rare (3 cm thick)	5	6 - 8
Steak, medium or well-done (3 cm thick)	4	8 - 12
Poultry breast (2 cm thick)*	3	10 - 20
Sausages, pre-boiled or raw*	3	8 - 20
Hamburger, meatballs, rissoles*	3	6 - 30
Stripes of meat, gyros	4	7 - 12
Minced meat	4	6 - 10
Bacon	2	5 - 8
Fish		
Fish, fried, whole, e.g. trout	3	10 - 20
Fish fillet, plain or breaded	3 - 4	10 - 20
Prawns, scampi	4	4 - 8
Egg dishes		
Pancakes**	5	1,5 - 2,5
Omelette**	2	3 - 6
Fried eggs	2 - 4	2 - 6
Scrambled eggs	2	4 - 9
Shredded raisin pancake	3	10 - 15
French toast**	3	4 - 8
Potatoes		
Fried potatoes (boiled in their skin)	5	6 - 12
Fried potatoes (made from raw potatoes)	4	15 - 25
Potato pancakes**	5	2,5 - 3,5
Swiss rösti	2	50 - 55
Glazed potatoes	3	15 - 20
Vegetables		
Garlic, onions	1 - 2	2 - 10
Courgettes, aubergines	3	4 - 12
Peppers, green asparagus	3	4 - 15
Vegetables sautéed in oil, e.g. courgettes, green peppers	1	10 - 20
Mushrooms	4	10 - 15
Glazed vegetables	3	6 - 10
Onion rings	3	5 - 10

* Turn several times.

** Total cooking time per portion. Fry in succession.

	Tempera- ture setting	Total frying time after the signal sounds (mins.)
Frozen products		
Escalope	4	15 - 20
Cordon bleu*	4	10 - 30
Poultry breast*	4	10 - 30
Chicken nuggets	4	10 - 15
Gyros, kebab	4	10 - 15
Fish fillet, plain or breaded	3	10 - 20
Fish fingers	4	8 - 12
French fries	5	4 - 6
Stir-fries meals, e.g. fried vegetables with chicken	3	6 - 10
Spring rolls	4	10 - 30
Camembert/cheese	3	10 - 15
Sauces		
Tomato sauce with vegetables	1	25 - 35
Béchamel sauce	1	10 - 20
Cheese sauce, e.g. Gorgonzola sauce	1	10 - 20
Reducing sauces, e.g. tomato sauce, Bolognese sauce	1	25 - 35
Sweet sauces, e.g. orange sauce	1	15 - 25
Miscellaneous		
Camembert/cheese	3	7 - 10
Dry ready meals that require water to be added, e.g. pasta	1	5 - 10
Croutons	3	6 - 10
Almonds/walnuts/pine nuts	4	3 - 15

* Turn several times.

** Total cooking time per portion. Fry in succession.

Setting procedure

Select the appropriate temperature level from the table. Set an empty item of cookware down on the cooking zone.

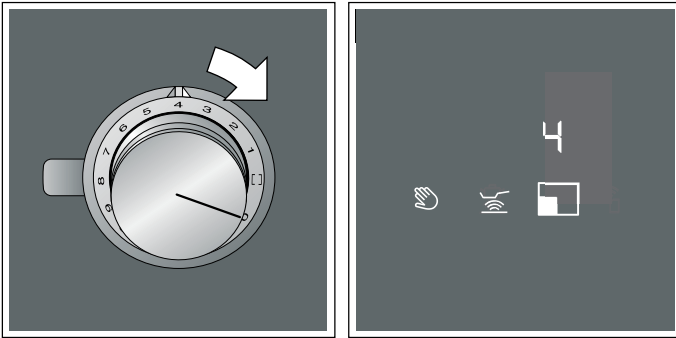

- 1 Use the control knob to select the temperature setting you require. Temperature settings 1 to 5 are available for this function; see temperature settings table.



- 2 Touch the  symbol; it will be lit orange. **R** and the temperature setting you have selected will be lit.



The function has now been activated.

The ,  or  temperature indicator and the temperature setting you have selected will remain lit until the frying temperature has been reached. An audible signal will then sound and the temperature indicator will go out.

- 3 Once the frying temperature has been reached, add the fat and then the food to the pan.

Notes

- If a temperature setting above 5 is selected, setting **5** will automatically be set. In this case, turn the control knob to position 5.
- Turn the food so that it does not burn.

Switching off the frying sensor

Turn the control knob that was used to select the temperature to position 0. The hotplate will switch off and the residual heat indicator will appear.

Locking the control panel for cleaning

Wiping over the control panel while the hob is switched on may alter the settings. To avoid doing this, you can use the hob's "Lock control panel for cleaning" function.

To switch on: Touch the  symbol. An audible signal will sound. The indicators for the active functions will flash. The control panel will be locked for 10 minutes. You will now be able to clean the surface of the control panel without altering the settings.

To switch off: Touch the  symbol again within the next 10 minutes.

If the function is not deactivated within these 10 minutes, the hob will switch itself off.

Notes

- The locking function does not affect the control knobs. The hob can be switched off at any time.
- While the locking function is active, the power supply to the hob is disconnected. The hotplates may still be hot.

Automatic safety switch-off function

For your protection, the appliance features a safety switch-off function. Depending on which heat setting has been selected, the hotplate's heating element will be deactivated if no further action is performed within a set time after selecting the heat setting.

Heat setting	Deactivated after
1	10 hours
2 to 4	5 hours
5 to 7	4 hours
8	3 hours
9 to 10	2 hours
11 to 12	1 hour

Frying sensor temperature setting	Deactivated after
1 to 5	3 hours

An audible signal will indicate when this time has elapsed. The control knob is active and the illuminated ring around it will flash. **FB** will be lit on the hotplate display.

Turn the control knob to position 0. The appliance can now be switched back on as usual.

Basic settings

The appliance has various basic settings. These basic settings can be altered to suit your individual requirements.

Display	Function
c 1	Signal tones
<i>ON</i>	All signal tones activated.*
<i>OFF</i>	Only fault signal activated.
c 2	Power management function. Limit the total power of the hob (watts)
<i>OFF</i>	Deactivated.*
<i>1000</i>	Lowest setting
<i>1500</i>	
<i>2000</i>	
...	
<i>9500</i>	Highest setting on the hob
c 3	Check cookware; cooking results
<i>0</i>	Not suitable
<i>1</i>	Not ideal
<i>2</i>	Suitable
c 4	Restore standard settings
<i>OFF</i>	Individual settings.*
<i>ON</i>	Restore factory settings.
c 5	Automatic fan start-up
<i>OFF</i>	Switched off. The hood must be switched on manually, if required.
<i>A</i>	Switched on in automatic mode.* In automatic mode, the hood switches itself on when you switch on one of the cooking zones.
<i>1/2/3</i>	Switched on in manual mode. The hood is switched on at a fixed fan setting when you switch on any of the cooking zones.
c 6	Fan run-on
<i>OFF</i>	The fan switches itself off when the hob is switched off.
<i>A</i>	Switched on in automatic mode.*
<i>ON</i>	Switched on with standard fan run-on.
<i>NO</i>	Settings cannot be changed.
c 7	Switch light on automatically
<i>OFF</i>	Switched off.*
<i>ON</i>	Switched on. The light switches itself on when the hob is switched on.

* Basic setting

Display	Function
c 8	Switch light off automatically
<i>OFF</i>	Switched off.* The light switches itself off when you switch off the hob.
<i>ON</i>	Switched on. The light switches itself on when you switch off the hob.
<i>FUN</i>	Switched on. The light switches itself on when the fan runs on and goes out when the fan run-on time ends.

* Basic setting

Notes

- The **c 5**, **c 6**, **c 7** and **c 8** settings are only displayed if the appliance is connected to an extractor hood.
- The **c 7** and **c 8** settings are only displayed if the appliance is connected to an extractor hood with a light.

To access the basic settings:

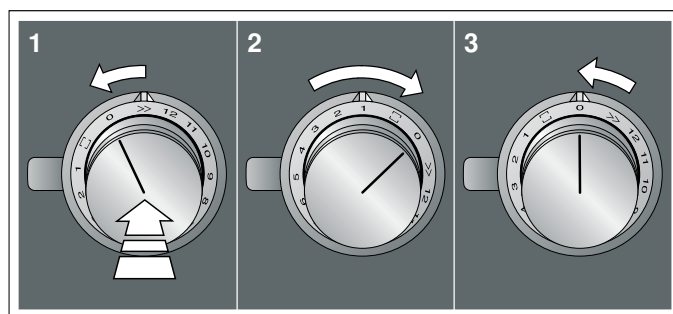

The hob must be off.

- 1 Carry out the following operating steps one after the other without interruption.
- 2 Push in one of the control knobs and turn it anti-clockwise to position >>>.
- 3 Turn the control knob clockwise to position 1.
- 4 Turn the control knob anti-clockwise to position 0. The  symbol will be lit. The illuminated ring around the control knob will be lit yellow.



- 5 Touch the  symbol.
The displays show the product information.

Product information	Display screen
After-sales service index (ASSI)	<i>01</i>
Production number	<i>Fd</i>
Production number 1	<i>95.</i>
Production number 2	<i>05</i>

- 6 Press the  symbol again to call up the basic settings.
 and  will light up by default on the displays.



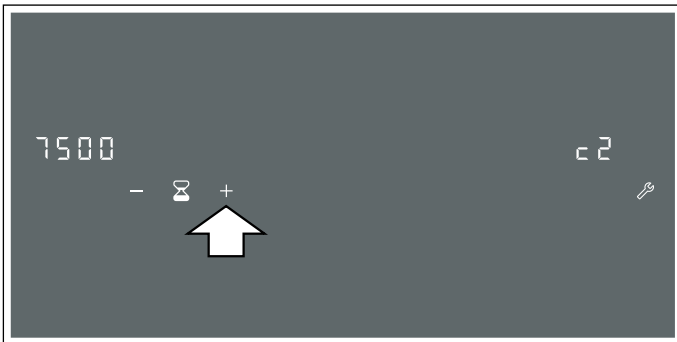

- 7 Touch the  symbol repeatedly until the required function is displayed.
 8 Then use the **+** and **-** symbols to select the required setting.



- 9 Touch the  symbol for at least 4 seconds.
 The settings have been saved.

Exiting the basic settings menu

- 1 Turn the control knob anti-clockwise to position .
 - 2 Turn the control knob clockwise to position 1.
 - 3 Turn the control knob anti-clockwise to position 0.
- The  symbol and the illuminated ring around the control knob will go out.

Home Connect

This hob is Wi-Fi-enabled; settings can be sent to the hob via a mobile device.

If the hob is not connected to the home network, the appliance functions in the same way as a hob with no network connection. The hob can always be operated via the control knob.

The availability of the Home Connect function depends on the availability of Home Connect services in your country. Home Connect services are not available in every country. You can find more information on this at www.home-connect.com.



Notes

- Hobs are not designed to be used unattended – you must always keep an eye on the cooking process.
- Ensure that you follow the safety instructions in this instruction manual and that these are also observed when operating the appliance via the Home Connect app. You must also follow the instructions in the Home Connect app. → "Important safety information" on page 5
- You can use the Home Connect app to change the basic settings for your hob. Remote start or setting a power level is not possible.
- Operating directly from the appliance always takes priority. It is not possible to operate the appliance using the Home Connect app during this time.

Home Connect settings menu

To connect your appliance to Home Connect or run WiFi connection settings, you must open the Home Connect settings menu on your appliance.

Note: It is important to carry out the following operating steps without interruption, one after the other.

- 1 Push in any control knob and turn one notch anti-clockwise to the  position. Keep the control knob pressed in.
- 2 Turn the control knob two notches clockwise to position  or . Keep the control knob pressed in.
- 3 Turn the control knob one notch anti-clockwise to position 0.

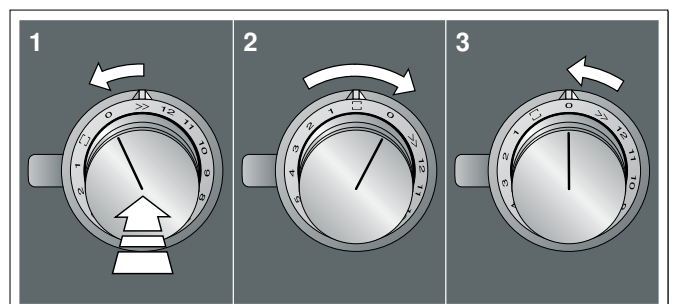

Note: If you select settings in the Home Connect settings menu, you must exit the Home Connect menu in the same way to save the settings.

Displays on the illuminated ring on the control knob

- While you are in the Home Connect menu, the illuminated ring on the control knob lights up blue.
- While the appliance is establishing a connection with the WiFi, the illuminated ring on the control knob flashes blue.
- If the appliance has established a connection with the WiFi, the illuminated ring on the control knob lights up green.
- If the appliance was not able to establish a connection with the WiFi, the illuminated ring on the control knob lights up red.

Setting up

To implement settings via Home Connect, you must have installed and set up the Home Connect app on your mobile device.

Note: In networked standby mode, your appliance requires max. 2 W.

Setting up the Home Connect app

Note: You require a mobile device with the latest version of the relevant operating system.

- 1 On your mobile device go to the App Store (Apple devices) or to the Google Play Store (Android devices).
- 2 Enter "Home Connect" in the search field.
- 3 Select the Home Connect app and install on your mobile device.
- 4 Start the app and create your Home Connect login details. The app will guide you through the registration process. Make a note of your e-mail address and password.

Connecting the appliance to your home network

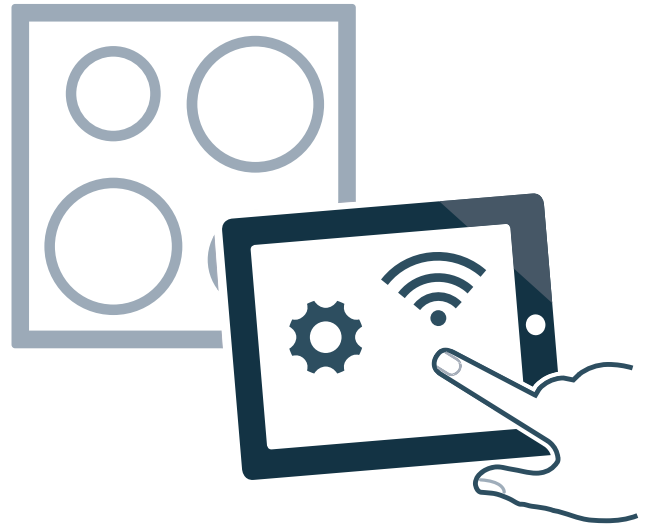

- 1 Carry out the following operating steps one after the other without interruption.
- 2 Push in any control knob and turn it anti-clockwise to the >>> position.
- 3 Turn the control knob clockwise to position □ or ☞.
- 4 Turn the control knob anti-clockwise to position 0. The illuminated ring on the control knob lights up blue.
- 5 Turn the control knob clockwise to position □ or ☞.
On the control panel, *HHC* and *CON 1* are displayed alternately. The illuminated ring on the control knob flashes blue. The hob is now ready for registration in the home network.

Automatic registration in the home network

You require a router that has WPS functionality. You can find information about this in the manual for your router. You need to be able to access your router.

If you cannot access it, follow the steps for "Manually logging into your home network".

- 1 Press the WPS button on the router within the next two minutes.
- 2 Launch the Home Connect app on your mobile device and follow the instructions for automatic network login.



Manual registration in the home network

Note: To log in to the WiFi manually, you require the network name (SSID) and password (key) for your home network.



- 1 Wait for two minutes until the illuminated ring on the control knob flashes red once and *CON 2* lights up on the control panel.
The appliance is now in manual mode.
- 2 Switch to the general settings menu of your mobile device and call up the WiFi settings.
The "Home Connect" WiFi connection is available on your mobile device.
- 3 Connect to the "Home Connect" (password: "HomeConnect") WiFi connection.
- 4 Launch the app on your mobile device and follow the instructions for automatic network login.
- 5 The appliance is available in the app on the mobile device once  lights up on the control panel and the illuminated ring on the control knob lights up green.

Note: If the illuminated ring on the control knob lights up red, it was not possible to establish a connection to the WiFi. Check the router and start the connection process again. Check that you have correctly entered the password.

Restart the connection process





- 1 Turn the control knob anti-clockwise to position **0**.
The illuminated ring on the control knob lights up blue.
- 2 Turn the control knob clockwise to position  or .
On the control panel, *HHC* and *CON 1* are displayed alternately. The illuminated ring on the control knob flashes blue. The hob is now ready for registration in the WiFi.

Exiting the Home Connect settings menu

- 1 Carry out the following operating steps one after the other without interruption.
- 2 Push in the control knob and turn it anti-clockwise to the  position.
- 3 Turn the control knob clockwise to position  or .
- 4 Turn the control knob anti-clockwise to position **0**.
The illuminated ring on the control knob goes out.

Switching WiFi off/on



You can switch off the Wi-Fi on your hob at any time (e.g. to save energy during a holiday). The connections to the home network and to the extractor hood remain saved. When you switch the Wi-Fi back on, the saved connections are applied.

- 1 Carry out the following operating steps one after the other without interruption.
- 2 Push in any control knob and turn it anti-clockwise to the  position.
- 3 Turn the control knob clockwise to position  or .
- 4 Turn the control knob anti-clockwise to position **0**.
The illuminated ring on the control knob lights up blue.
- 5 Turn the control knob clockwise to position **1**.
The illuminated ring on the control knob lights up green.  lights up on the control panel. After five seconds, the Wi-Fi is switched off and the illuminated ring on the control knob lights up blue.
The  symbol on the control panel goes out.

If you want to switch the WiFi back on, run through the same operating sequence. The illuminated ring on the control knob lights up blue. After 5 seconds, the WiFi is switched on and the illuminated ring around the control knob lights up green.  lights up on the control panel.

Resetting connection

You can reset the connections you have saved for your home network and extractor hood at any time.

- 1 Carry out the following operating steps one after the other without interruption.
- 2 Push in any control knob and turn it anti-clockwise to the  position.
- 3 Turn the control knob clockwise to position  or .
- 4 Turn the control knob anti-clockwise to position **0**.
The illuminated ring on the control knob lights up blue.
- 5 Turn the control knob clockwise to position **2**.
RES lights up on the control panel. After 30 seconds, the connection is reset and the illuminated ring on the control knob flashes. The connection is reset once *DONE* lights up on the control panel and the illuminated ring on the control knob lights up green.

Software update

The software update function is used to update your hob's software (e.g. for the purpose of optimisation, troubleshooting or security updates). To do this, you need to be a registered Home Connect user, have installed the app on your mobile device and be connected to the Home Connect server.

As soon as a software update is available, you will be informed by the Home Connect app, from which you will also be able to download the update.

Notes

- You can continue to use your hob as normal while updates are downloading.
- Depending on your personal settings in the app, software updates can also be set to download automatically.
- We recommend that you install security updates as soon as possible.

Remote diagnostics

Customer Service can use Remote Diagnostics to access your appliance if you contact them, have your appliance connected to the Home Connect server and if Remote Diagnostics is available in the country in which you are using the appliance.

Note: For further information and details about the availability of Remote Diagnostics in your country, please visit the service/support section of your local website: www.home-connect.com

About data protection

When your appliance is connected for the first time to a WLAN network, which is connected to the Internet, your appliance transmits the following categories of data to the Home Connect server (initial registration):

- Unique appliance identification (consisting of appliance codes as well as the MAC address of the installed WiFi communication module).
- Security certificate of the WiFi communication module (to ensure a secure IT connection).
- The current software and hardware version of your domestic appliance.
- Status of any previous resetting to factory settings.

This initial registration prepares the Home Connect functions for use and is only required when you want to use these Home Connect functions for the first time.

Note: Ensure that the Home Connect functions can be used only in conjunction with the Home Connect app. Information on data protection can be accessed in the Home Connect app.

Declaration of Conformity

Gaggenau Hausgeräte GmbH hereby declares that the appliance which features Home Connect is in accordance with the basic requirements and the other relevant provisions of the directive 2014/53/EU.

A detailed RED Declaration of Conformity can be found online at www.gaggenau.com on the product page for appliance in the additional documents.



2.4 GHz band: max. 100 mW

5 GHz band: max. 100 mW



BE	BG	CZ	DK	DE	EE	IE	EL
ES	FR	HR	IT	CY	LV	LT	LU
HU	MT	NL	AT	PL	PT	RO	SI
SK	FI	SE	UK	NO	CH	TR	

5 GHz Wi-Fi: for indoor use only

Connecting an extractor hood

You can connect this appliance to a suitable extractor hood and then control the functions of the hood via your hob.

There are two options for connecting the appliances to each other:

Connecting appliances via the home network

If both appliances are compatible with Home Connect, you can connect them via the home network. The appliances are connected via the Home Connect app. You can also use both the hood control and Home Connect.

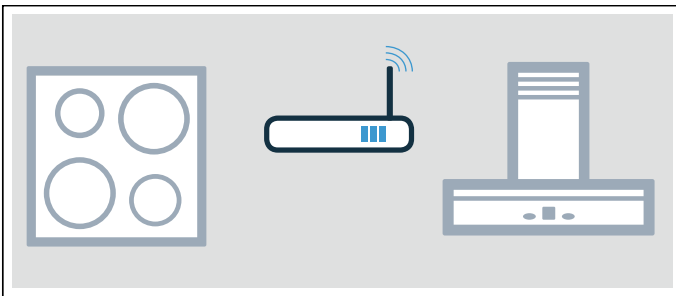

Connecting appliances directly

You can connect both appliances directly, without connecting to a home network. It is not possible to use the Home Connect functions. The appliance works as a hob with no network connection.

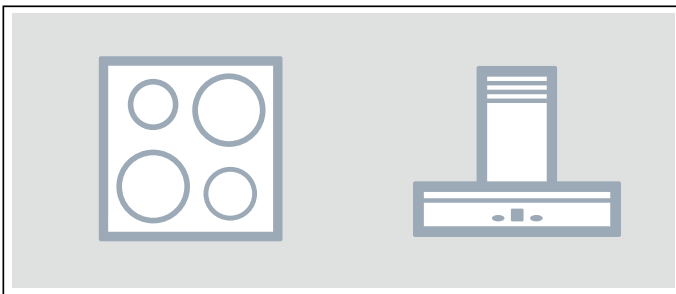

Notes

- Make sure you follow the safety instructions in the instruction manual for your extractor hood and that these are complied with even when operating the appliance via the hood controls on the hob.
- Using the controls on the extractor hood always takes priority. It is not possible to use the hood controls on the hob during this time.
- In networked standby mode, your appliance requires a maximum of 2 W.

Connecting via the home network

Ensure that both appliances are connected to the Home Connect app.

Select the required hob in the Home Connect app. In the settings, you can search for the required extractor hood and connect to the hob.



You can connect several hobs that are compatible with Home Connect to an extractor hood:

- 1 Connect the first hob to the extractor hood.
- 2 Switch off the Wi-Fi on the hob.
- 3 Connect the second hob to the extractor hood.
- 4 Switch the Wi-Fi on the first hob back on again.

Connecting directly

Note: If you connect your hob directly to the extractor hood, it can no longer be connected to your home network as well and you can no longer use Home Connect.

- 1 Carry out the following operating steps one after the other without interruption.
- 2 Push in one of the control knobs and turn it anti-clockwise to position **>>**.
- 3 Turn the control knob clockwise to position **□** or **☑**.
- 4 Turn the control knob anti-clockwise to position **0**. The illuminated ring on the control knob lights up blue.
- 5 Turn the control knob clockwise to position **□** or **☑**.
On the control panel, **HHC** and **CON 1** are displayed alternately. The illuminated ring on the control knob flashes blue. The hob is now ready for registration in the home network.
- 6 You have two minutes to initiate the connection on the extractor hood. For more information, refer to the section entitled "Connecting to the hob" in the instruction manual for your extractor hood. The connection process may take a few minutes. The hob is connected to the extractor hood once **PR 1** lights up on the control panel and the illuminated ring on the control knob lights up green. The **Wi-Fi** symbol is displayed on the hob's control panel.

Save the connection and exit the settings menu

- 1 Carry out the following operating steps one after the other without interruption.
- 2 Push in the control knob and turn it anti-clockwise to the **>>** position.
- 3 Turn the control knob clockwise to position **□** or **☑**.
- 4 Turn the control knob anti-clockwise to position **0**. The illuminated ring on the control knob goes out.

Control the hood via the hob

In the Home Connect app, you can adjust the behaviour of your extractor hood depending on whether the hob or individual cooking zones are switched on or off.

Cookware test

This function can be used to check the speed and quality of the cooking process depending on the cookware.

The result is a reference value and depends on the properties of the cookware and the hotplate being used.

- 1 Fill the pan with approximately 200 ml water and place it at room temperature in the middle of the hotplate that most closely matches the diameter of the pan base.
- 2 Go to the basic settings and select the **C3** setting. **OFF** will be lit.
- 3 Touch the **+** or **-** symbol. **ON** will be lit. A signal tone will sound and the hotplate indicators will be lit.

The function has now been activated.

ON will be lit. After a few seconds, the hotplate displays will show the results for the quality and speed of the cooking process.

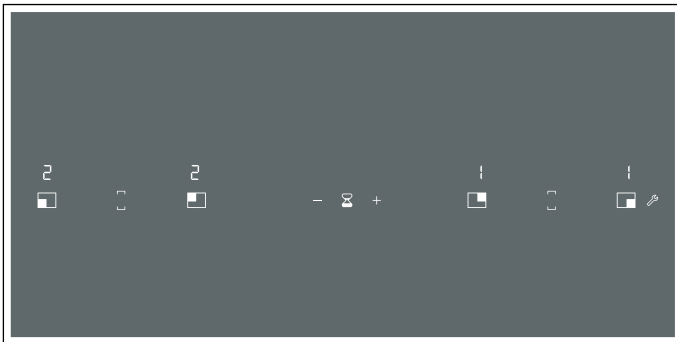

Check the result using the following table:

Result	
	The cookware is not suitable for the hotplate and will therefore not heat up.*
	The cookware is taking longer to heat up than expected and the cooking process is not going as well as it should.*
	The cookware is heating up correctly and the cooking process is going well.

* If there is a smaller hotplate available, test the cookware again on the smaller hotplate.

To activate the function again, select the **+** or **-** symbol.

Notes

- Do not use the wok or wok accessories with this function.
- The Flex cooking zone is set to function as a single hotplate; only test one item of cookware at a time on it.
- If the diameter of the hotplate that is used is much smaller than the diameter of the cookware, only the middle of the cookware can be expected to heat up. This may result in the cooking results not being as good as expected or being less than satisfactory.
- You can find information on this function in the section entitled → "Basic settings".
- You can find information on the type, size and positioning of the cookware in the sections entitled → "Induction cooking" and → "Flexible cooking zone".

Cleaning

Suitable maintenance and cleaning products can be purchased from the after-sales service or in our e-Shop.

Hob

Cleaning

Always clean the hob after cooking. This will prevent food deposits from becoming burned on. Only clean the hob after the residual heat indicator has gone out.

Clean the hob with a damp dish cloth and dry it with a cloth or towel to prevent limescale build-up.

Only use cleaning agents that are suitable for this type of hob. Observe the manufacturer's instructions on the product packaging.

Never use:

- Undiluted washing-up liquid
- Cleaning agents designed for dishwashers
- Abrasive cleaners
- Harsh cleaning agents, such as oven spray and limescale remover
- Scouring pads
- High-pressure cleaners or steam jet cleaners

Stubborn dirt is best removed with a glass scraper, available from retailers. Observe the manufacturer's instructions.

You can obtain a suitable glass scraper from customer services or through our online shop.

Using a special sponge for cleaning glass-ceramic hobs achieves a great cleaning result.

Potential marks

Limescale and water marks	Clean the hob as soon as it has cooled down. You can use a cleaning agent suitable for glass-ceramic hobs.*
Sugar, rice starch or plastic	Clean immediately. Use a glass scraper. Caution: Risk of burns.*

* Then clean with a damp dish cloth and dry with a cloth or towel.

Note: Do not use any cleaning agents while the hob is still hot. This may mark the surface. Make sure that any residue left by cleaning agents is removed.

Hob surround

To prevent damage to the hob surround, observe the following instructions:

- Only use warm soapy water
- Wash new dish cloths thoroughly before use.
- Do not use harsh or abrasive cleaning agents.
- Do not use a glass scraper or sharp objects.

Control knob

Only use warm detergent solution. Do not use harsh or abrasive cleaning products. Do not use a glass scraper, as this may damage the control knob.

Lemon and vinegar are not suitable for cleaning the control knob, as this may cause dull patches to appear on the knob.

Frequently Asked Questions (FAQ)

Noises

Why can I hear noises while I'm cooking?

Noises may be generated while using the hob depending on the characteristics of the base of the cookware. These noises are normal for induction technology. They do not indicate a defect.

Possible noises:

A low humming noise of the kind a transformer makes:

Occurs when cooking at a high heat setting. The noise disappears or becomes quieter when the heat setting is reduced.

Low whistling noise:

Occurs when the cookware is empty. The noise disappears when water or food is added to the cookware.

Crackling:

Occurs when using cookware made from layers of different material or when using cookware of different sizes and different materials at the same time. The volume of the noise may vary depending on the quantity of food being cooked and the cooking method.

High-pitched whistling noises:

May occur if two hotplates are used at the highest heat setting at the same time. The whistling noises disappear or become quieter when the heat setting is reduced.

Fan noise:

The hob is equipped with a fan that automatically switches on at high temperatures. The fan may continue to run even after you have switched off the hob if the temperature detected is still too high.

Cookware

Which types of cookware can be used with the induction hob?

You can find information on which types of cookware can be used with an induction hob in the section entitled → "*Induction cooking*".

Why is the hotplate not heating up and why is the heat setting flashing?

The cookware is on a different hotplate to the one that has been switched on.

Check that you have switched on the correct hotplate.

The cookware is too small for the hotplate that is switched on or it is not suitable for induction cooking.

Check that the cookware is suitable for induction cooking and that it is placed on the hotplate that best corresponds to its size. You can find information on the type, size and positioning of the cookware in the sections entitled → "*Induction cooking*" and → "*Flexible cooking zone*".

Why is it taking so long for the cookware to heat up or why is it not heating up sufficiently despite being on a high heat setting?

The cookware is too small for the hotplate that is switched on or it is not suitable for induction cooking.

Check that the cookware is suitable for induction cooking and that it is placed on the hotplate that best corresponds to its size. You can find information on the type, size and positioning of the cookware in the sections entitled → "*Induction cooking*" and → "*Flexible cooking zone*".

Cleaning

How do I clean the hob?

Optimal results can be achieved with cleaning products specifically for use on glass-ceramic surfaces. Do not use harsh or abrasive cleaning products, dishwasher detergents (concentrates) or floorcloths.

You can find more information on cleaning and caring for your hob in the section entitled → "*Cleaning*".

Trouble shooting

Usually, faults are small matters that are easy to eliminate. Please read the information in the table before calling the after-sales service.

Display	Possible cause	Solution
None	The power supply has been disconnected. The appliance has not been connected as shown in the circuit diagram. Electronics fault.	Use other electrical appliances to check whether a short circuit has occurred in the power supply. Make sure that the appliance has been connected as shown in the circuit diagram. If the fault cannot be rectified, inform the technical after-sales service.
A signal sounds.	The control panel is wet or an object is covering it.	Dry the control panel or remove the object.
The hotplate has been switched off. The illuminated ring on the control knob is flashing.	The control knob has not been turned for an extended period. The automatic safety cut-out function has been activated.	Turn the control knob to position 0. Switch the hotplate back on.
	The appliance is too hot.	Read the fault message on the control panel.
The hotplate indicator is flashing.	The cookware is not being detected. Make sure that the cookware is suitable for use with an induction hob.	Make sure that the diameter of the base of the cookware corresponds to the size of the hotplate. Turn the control knob to position 0. Switch the hotplate back on.
F2	The electronics have overheated and have switched off the affected hotplate.	Remove any cookware from the hotplate. Once the fault code goes out, the hotplate has cooled down sufficiently. Turn the control knob to position 0. Then select the heat setting as usual.
F4	The electronics have overheated and all of the cooking zones have been switched off.	
F5 + heat setting and signal tone	There is hot cookware near the control panel. There is a risk that the electronics will overheat.	Remove the cookware. The fault code goes out shortly afterwards. You can resume cooking.
F5 and signal tone	There is hot cookware near the control panel. The cooking zone has been switched off to protect the electronics.	Remove the cookware. Wait a few seconds. When the fault code on the display goes out, you can resume cooking.
F1/F6	The hotplate has overheated and has been switched off to protect the work surface.	Wait until the electronics have cooled down sufficiently before switching the hotplate on again.
F8	The hotplate has been operating continuously for an extended period.	The automatic safety cut-out function has been activated. See section → " <i>Automatic safety switch-off function</i> ".
F9	The FlexPlus cooking zone cannot be activated.	Touch any touch control to check the fault code. You can use the remaining cooking zones to cook as usual. Contact our technical after-sales service.
E9000 E90 10	The operating voltage is incorrect/outside of the normal operating range.	Contact your electricity supplier.
U400	The hob is not connected correctly.	Disconnect the hob from the mains. Make sure that it has been connected as shown in the circuit diagram.
Do not place hot cookware on the control panel.		

Notes

- If the fault code is not listed in the table, disconnect the hob from the mains power supply and wait 30 seconds before reconnecting it. If this code is displayed again, contact the technical after-sales service and specify which fault code has appeared.
- If a fault occurs, the appliance will not switch to standby mode.

Demo mode

If **dE ON** is displayed, demo mode has been activated. The appliance will not heat up. Disconnect the appliance from the power supply. Wait 30 seconds before reconnecting it. Then deactivate demo mode within 3 minutes as follows:

- 1 Turn one of the control knobs anti-clockwise to position **>>**.
- 2 Turn the same control knob clockwise to position 1.
- 3 Turn the same control knob anti-clockwise to position 0.
The illuminated ring around the control knob will be lit yellow.
- 4 Turn the same control knob clockwise to position 1.
ON will be lit and the illuminated ring will be green.
Wait 5 seconds. **OFF** will be lit and the illuminated ring will turn yellow.

Demo mode has now been deactivated.

Customer service

Our after-sales service is there for you if your appliance needs to be repaired. We will always find an appropriate solution, also in order to avoid after-sales personnel having to make unnecessary visits.

E number and FD number

When calling us, please quote the full product number (E no.) and the production number (FD no.) so that we can provide you with the correct advice. The rating plate that features these numbers can be found on the underside of the appliance.

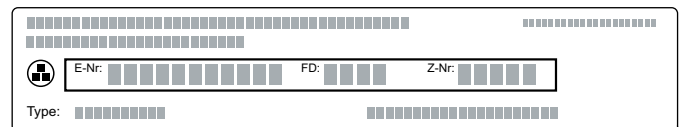

The product number (E no.) can also be found on the glass-ceramic hob. You can check the after-sales service index (KI) and production number (FD no.) by going to the basic settings. Refer to the section entitled → "*Basic settings*" to find out how to do this.

To save time, you can make a note of the numbers for your appliance and the telephone number of the after-sales service in the space below in case you need them.

E no.

FD no.

After-sales service ☎

Please note that a visit from an after-sales service engineer is not free of charge in the event that the appliance has been misused, even during the warranty period.

Please find the contact data of all countries in the enclosed customer service list.

To book an engineer visit and product advice

GB 0344 892 8988
Calls charged at local or mobile rate.

IE 01450 2655
0.03 € per minute at peak.
Off peak 0.0088 € per minute.

AU 1300 368 339

NZ 09 477 0492

Trust the expertise of the manufacturer, and rest assured that the repair will be carried out by trained service technicians using original spare parts for your domestic appliance.

Gaggenau Hausgeräte GmbH
Carl-Wery-Straße 34
81739 München
GERMANY
www.gaggenau.com

9001461816 (000214)
en

GAGGENAU

