

Gaggenau

User manual



DF270..., DF271...

Dishwasher

Table of contents

| | | | |
|--|-----------|--|-----------|
| Safety | 4 | Features | 23 |
| General information | 4 | Top basket | 24 |
| Intended use | 4 | Bottom basket | 26 |
| Restriction on user group | 4 | Cutlery basket | 27 |
| Safe installation | 5 | Cutlery drawer | 27 |
| Safe use | 6 | Etagere | 29 |
| Damaged appliance | 8 | Folding prongs | 29 |
| Risk to children | 9 | Small items holder | 30 |
| Safety systems | 10 | Knife shelf | 30 |
| Preventing material damage | 11 | Baking sheet spray head | 30 |
| Safe installation | 11 | Basket heights | 31 |
| Safe use | 11 | Before using for the first time | 32 |
| Childproof lock¹ | 12 | Performing initial start-up | 32 |
| Electric childproof lock | 12 | Water softening system | 32 |
| Environmental protection and saving energy | 12 | Overview of water hardness settings | 32 |
| Disposing of packaging | 12 | Setting water softening system | 33 |
| Saving energy | 12 | Special salt | 33 |
| Zeolith drying  | 13 | Switching off water softening system | 34 |
| AquaSensor ¹ | 13 | Regeneration of the water softening system | 34 |
| Sensors | 13 | Rinse aid system | 35 |
| Installation and connection | 14 | Rinse aid | 35 |
| Scope of supply | 14 | Setting the amount of rinse aid | 36 |
| Installing and connecting the appliance | 14 | Switching rinse aid system off | 36 |
| Drainage connection | 14 | Detergent | 36 |
| Drinking water connection | 15 | Suitable detergents | 36 |
| Electrical connection | 15 | Unsuitable detergents | 37 |
| Familiarising yourself with your appliance | 16 | Information on detergents | 37 |
| Appliance | 16 | Adding detergent | 38 |
| Controls | 17 | Tableware | 39 |
| Programmes | 20 | Damage to glass and tableware | 39 |
| Information for test institutes | 22 | Arrange tableware | 40 |
| Additional functions | 22 | Removing tableware | 41 |

¹ Depending on the appliance specifications

| | | | |
|---|-----------|--|-----------|
| Basic operation | 41 | Error code / Fault display / Signal..... | 55 |
| Opening appliance door | 41 | Washing results..... | 57 |
| Switching on the appliance | 41 | Home Connect problem..... | 64 |
| Setting a programme | 41 | Information on display panel..... | 64 |
| Setting additional functions | 41 | Malfunctions | 65 |
| Setting timer programming | 41 | Mechanical damage..... | 66 |
| Starting the programme | 42 | Noise | 66 |
| Interrupting programme | 42 | Clean wastewater pump..... | 67 |
| Terminate programme..... | 42 | Transportation, storage and disposal | 67 |
| Display programme information.... | 42 | Removing the appliance | 67 |
| Switching off appliance | 42 | Protect appliance from frost..... | 68 |
| Basic settings..... | 43 | Transporting the appliance | 68 |
| Overview of basic settings | 43 | Disposing of old appliance | 68 |
| Changing basic settings..... | 45 | Customer Service..... | 68 |
| Setting the time | 45 | Product number (E-Nr.) and production number (FD)..... | 69 |
| Home Connect | 45 | AQUA-STOP guarantee ¹ | 69 |
| Installing app | 46 | Technical specifications..... | 69 |
| Automatically connecting appliance to WLAN home network (Wi-Fi) | 46 | | |
| Connecting appliance to WLAN home network (Wi-Fi) manually..... | 47 | | |
| Home Connect settings..... | 47 | | |
| Remote start  | 48 | | |
| Remote Diagnostics | 48 | | |
| Energy manager  | 48 | | |
| Data protection..... | 49 | | |
| Declaration of Conformity..... | 49 | | |
| Cleaning and servicing | 50 | | |
| Cleaning the tub | 50 | | |
| Self-cleaning interior ¹ | 50 | | |
| Cleaning products | 50 | | |
| Tips on appliance care..... | 50 | | |
| Machine Care  ¹ | 50 | | |
| Filter system | 51 | | |
| Cleaning spray arms | 52 | | |
| Troubleshooting..... | 54 | | |
| Appliance safety | 54 | | |

¹ Depending on the appliance specifications



Safety

Please read the safety information to ensure that you use the appliance safely.

General information

- Read this instruction manual carefully. Only this will ensure you use the appliance safely and efficiently.
- Keep the instruction manual and the product information safe for future reference or for the next owner.
- Check the appliance after unpacking it. Do not connect the appliance if it has been damaged in transit.

Intended use

Read the information on intended use to ensure that you use the appliance correctly and safely.

Only use this appliance:

- For cleaning household tableware.
- In private households and in enclosed spaces in a domestic environment.
- Up to an altitude of max. 2500 m above sea level.

Restriction on user group

Avoid risks to children and vulnerable persons.

This appliance may be used by children aged 8 or over and by people who have reduced physical, sensory or mental abilities or inadequate experience and/or knowledge, provided that they are supervised or have been instructed on how to use the appliance safely and have understood the resulting dangers.

Children must not play with the appliance.

Cleaning and user maintenance must not be performed by children unless they are being supervised.

Keep children under the age of 8 years away from the appliance and power cable.

Safe installation

Follow these safety instructions when installing the appliance.

WARNING – Risk of injury!

Improper installation may cause injury.

- ▶ When installing and connecting the appliance, follow the instructions in the manual and installation instructions.

WARNING – Risk of electric shock!

- Improper installation is dangerous.
 - ▶ Connect and operate the appliance only in accordance with the specifications on the rating plate.
 - ▶ Connect the appliance to a power supply with alternating current only via a properly installed socket with earthing.
 - ▶ The protective conductor system of the domestic electrical installation must be properly installed.
 - ▶ Never equip the appliance with an external switching device, e.g. a timer or remote control.
 - ▶ When the appliance is installed, the mains plug of the power cord must be freely accessible. If free access is not possible, an all-pole isolating switch must be installed in the permanent electrical installation according to the installation regulations.
 - ▶ When installing the appliance, check that the power cable is not trapped or damaged.
- Cutting through the supply hose or immersing the Aqua-Stop valve in water is dangerous.
 - ▶ Never immerse the plastic housing in water. The plastic housing on the supply hose contains an electric valve.
 - ▶ Never cut through the supply hose. The supply hose contains electric power cables.

WARNING – Risk of fire!

It is dangerous to use an extended power cord and non-approved adapters.

- ▶ Do not use extension cables or multiple socket strips.
- ▶ If the power cord is too short, contact Customer Service.

- ▶ Only use adapters approved by the manufacturer.

⚠ WARNING – Risk of injury!

Hinges move when opening and closing the appliance door and can cause injury.

- ▶ If built-under or integrable appliances are not in a cavity so that one side is accessible, the hinge area must be covered at the side. Covers are available from Customer Service or specialist outlets.

⚠ WARNING – Risk of tipping!

Improper installation may cause the appliance to tip up.

- ▶ Only install built-under or integrable appliances under a continuous worktop that is securely connected to adjacent cabinets.

⚠ WARNING – Risk of burns!

If the appliance is not installed properly, this may result in burns.

- ▶ With free-standing appliances, ensure that they are installed with the back panel against a wall.

Safe use

⚠ WARNING – Risk of serious harm to health!

Failure to comply with safety instructions and directions for use on packagings of detergent and rinse aid products may cause serious harm to health.

- ▶ Follow the safety instructions and directions for use on the packagings of detergent and rinse aid products.

⚠ WARNING – Risk of explosion!

- Adding solvents to the interior of the appliance may cause explosions.
 - ▶ Never add solvents to the interior of the appliance.

- Highly caustic alkaline or highly acidic cleaning agents in conjunction with aluminium parts in the interior of the appliance may cause explosions.
 - ▶ Never use highly caustic alkaline or highly acidic cleaning agents, in particular commercial or industrial products, in conjunction with aluminium parts (e.g. grease filters of extractor hoods or aluminium pans), e.g. for the Machine Care programme.

⚠ WARNING – Risk of injury!

- Leaving the appliance door open may result in injury.
 - ▶ Only open the appliance door to load or unload tableware in order to prevent accidents, e.g. through tripping.
 - ▶ Do not sit or stand on the appliance door when open.
- Knives and utensils with sharp points can cause injuries.
 - ▶ Arrange knives and utensils with sharp points in the cutlery basket with the points downwards, on the knife shelf or in the cutlery drawer.

⚠ WARNING – Risk of scalding!

If you open the appliance door while the programme is running, hot water may splash out of the appliance.

- ▶ Open the appliance door carefully if the programme is still running.

⚠ WARNING – Risk of tipping!

Overfilling the Baskets may cause the appliance to tip up.

- ▶ Never overfill the Baskets with free-standing appliances.

⚠ WARNING – Risk of electric shock!

- An ingress of moisture can cause an electric shock.
 - ▶ Only use the appliance in enclosed spaces.
 - ▶ Never expose the appliance to intense heat or humidity.
 - ▶ Do not use steam- or high-pressure cleaners to clean the appliance.

- If the insulation of the power cord is damaged, this is dangerous.
 - ▶ Never let the power cord come into contact with hot appliance parts or heat sources.
 - ▶ Never let the power cord come into contact with sharp points or edges.
 - ▶ Never kink, crush or modify the power cord.



WARNING – Risk of burns!

The blow opening of the Zeolith container becomes hot and can cause burns.

- ▶ Never touch the blow opening of the Zeolith container.

Damaged appliance

Follow the safety instructions if the appliance is damaged.



WARNING – Risk of electric shock!

- If the appliance or the power cord is damaged, this is dangerous.
 - ▶ Never operate a damaged appliance.
 - ▶ Never operate an appliance with a cracked or fractured surface.
 - ▶ Never pull on the power cord to unplug the appliance. Always unplug the appliance at the mains.
 - ▶ If the appliance or the power cord is damaged, immediately unplug the power cord or switch off the fuse in the fuse box and turn off the water tap.
 - ▶ "Call Customer Service." → *Page 68*
 - ▶ Repairs to the appliance should only be carried out by trained specialist staff.
- Incorrect repairs are dangerous.
 - ▶ Repairs to the appliance should only be carried out by trained specialist staff.
 - ▶ Only use genuine spare parts when repairing the appliance.
 - ▶ If the power cord of this appliance is damaged, it must be replaced with a special connection cable, which is available from the manufacturer or his Customer Service.

Risk to children

Follow the safety instructions if there are children in your home.

WARNING – Risk of suffocation!

- Children may put packaging material over their heads or wrap themselves up in it and suffocate.
 - ▶ Keep packaging material away from children.
 - ▶ Do not let children play with packaging material.
- Children may breathe in or swallow small parts, causing them to suffocate.
 - ▶ Keep small parts away from children.
 - ▶ Do not let children play with small parts.

WARNING – Risk of harm to health!

Children can lock themselves in the appliance, thereby putting their lives at risk.

- ▶ With redundant appliances, unplug the power cord. Then cut through the cord and damage the lock on the appliance door beyond repair so that the appliance door will no longer close.

WARNING – Risk of crushing!

With higher-level appliances, children can become crushed between the appliance door and cabinet doors underneath.

- ▶ Keep an eye on children when opening and closing the appliance door.

WARNING – Risk of chemical burns!

Rinse aid and detergent may cause chemical burns to the mouth, throat and eyes.

- ▶ Keep children away from detergent and rinse aid products.
- ▶ Keep children away from the appliance when open. The water in the interior of the dishwasher is not drinking water. It may contain residues of detergents and rinse aid.

⚠ WARNING – Risk of injury!

Children may get their fingers caught in the slots of the tablet collecting tray and injure themselves.

- ▶ Keep children away from the appliance when open.

⚠ WARNING – Risk of suffocation!

Children may become trapped in the appliance and suffocate.

- ▶ Use the childproof lock if fitted.
- ▶ Never let children play with or operate the appliance.

Safety systems

Protect children from possible hazards resulting from the appliance.

Depending on the features of the model, the appliance comes with a

→ *"Childproof lock", Page 12.*

Preventing material damage

Safe installation

Follow the instructions when installing the appliance.

ATTENTION!

- Improper installation of the appliance may cause damage.
 - ▶ If the dishwasher is installed above or below other domestic appliances, follow the information on installation in combination with a dishwasher in the installation instructions for the individual appliances.
 - ▶ If there is no information or if the installation instructions do not include the relevant information, contact the manufacturer of these appliances to check that the dishwasher can be installed above or below these appliances.
 - ▶ If no information is available from the manufacturer, the dishwasher should not be installed above or below such appliances.
 - ▶ To ensure the safe operation of all domestic appliances, continue following the installation instructions for the dishwasher.
 - ▶ Do not install the dishwasher under a hob.
 - ▶ Do not install the dishwasher near heat sources, e.g. radiators, heat storage tanks, ovens or other appliances that generate heat.
- Modified or damaged water hoses may result in material damage and damage to the appliance.
 - ▶ Never kink, crush, modify or cut through water hoses.

- ▶ Only use the water hoses supplied with the appliance or genuine spare hoses.
- ▶ Never re-use water hoses that have been used before.
- If the water pressure is too high or too low, this may impair functioning of the appliance.
 - ▶ Make sure that the water pressure in the water supply system is min. 50 kPa (0,5 bar) and max. 1000 kPa (10 bar).
 - ▶ If the water pressure exceeds the maximum value specified, a pressure-reducing valve must be installed between the drinking water connection and the hose set of the appliance.

Safe use

Follow the instructions when using the appliance.

ATTENTION!

- Escaping water vapour can damage fitted units.
 - ▶ When the programme ends, leave the appliance to cool down for a while before opening the door.
- Special salt can damage the tub due to corrosion.
 - ▶ To make sure that any special salt that escapes is washed out of the tub, add the special salt to the dispenser for special salt immediately before the programme starts.
- Detergent may damage the water softening system.
 - ▶ Only fill the dispenser of the water softening system with special dishwasher salt.
- Unsuitable cleaning agents may damage the appliance.
 - ▶ Do not use a steam cleaner.

- ▶ So as not to scratch the finish on the appliance, do not use sponges with a rough surface or abrasive cleaning agents.
- ▶ To prevent corrosion, do not use sponge cloths on dishwashers with a stainless steel front or rinse such cloths thoroughly several times before using them for the first time.

Childproof lock¹

The childproof lock lets you protect children from possible hazards resulting from the appliance.

Depending on the features of the appliance model, the appliance comes with an electric childproof lock.

Electric childproof lock

The electric childproof lock makes it more difficult to open the appliance door.

You can activate or deactivate the electric childproof lock in the "Basic settings" → *Page 43*.

WARNING **Risk of suffocation!**

Children may become trapped in the appliance and thus suffocate.

- ▶ Activate the electric childproof lock and close the appliance door.

→ *"Opening appliance door", Page 41*

Environmental protection and saving energy

Help protect the environment by using your appliance in a way that conserves resources and by disposing of reusable materials properly.

Disposing of packaging

The packaging materials are environmentally compatible and can be recycled.

- ▶ Sort the individual components by type and dispose of them separately.

Information about current disposal methods are available from your specialist dealer or local authority.

Saving energy

If you follow these instructions, your appliance will use less electricity and less water.

Use the Eco 50° programme.

- + The Eco 50° programme is energy efficient and environmentally friendly.
→ *"Programmes", Page 20*

If you do not have much tableware to wash, use the additional Half Load function.¹

- + The programme will adjust to a lower load and consumption will be reduced.
→ *"Additional functions", Page 22*

Change the sensor setting to the default.

- + Consumption is reduced.
→ *"Sensors", Page 13*

¹ Depending on the appliance specifications

Zeolith drying automatically helps to save energy.

+ → "Zeolith drying ②", Page 13

Zeolith drying ②

The appliance features a Zeolith container. Zeolith drying lets you save energy.

Zeolite is a mineral that can store moisture and heat energy and then release them again.

During dishwashing heat energy is used to heat up the washing water and dry the mineral.

During the drying phase moisture from the interior of the dishwasher is stored in the mineral and heat energy is released. The heat energy is blown out into the interior of the dishwasher with dry air. This speeds up and improves drying.

Zeolith drying therefore saves a great deal of energy.

Tip: To avoid impairing Zeolith drying performance, do not position tableware parts directly in front of the intake opening or the blow opening of the Zeolith container.

Do not position heat-sensitive tableware parts directly in front of the blow opening of the Zeolith container.

→ "Appliance", Page 16

AquaSensor¹

The AquaSensor is an optical measuring device (light barrier) which measures the turbidity of the washing water. You can save water with the AquaSensor.

Use of the AquaSensor depends on the programme. If the soiling level is low, the washing water is used in the next wash cycle, so reducing water

consumption by 3-6 litres. If the soiling level is greater, the washing water is drained off and replaced with fresh water. In the automatic programmes the temperature and running time are additionally adjusted to the level of soiling.

Sensors

The sensors adjust the programme sequence and strength in the automatic programmes depending on the level and type of soiling.

The sensor has different sensitivity settings that can be changed in the basic settings.

→ "Changing basic settings", Page 45

| Sensor setting | Description |
|----------------|--|
| Standard | Optimum setting for a mixed load and heavily soiled tableware. Saves both energy and water. |
| Sensitive | Adjusts the programme strength for effective removal of food remnants even with low soiling levels. Energy and water consumption are adjusted accordingly. |
| Very sensitive | Adjusts the programme strength for difficult conditions of use, e.g. stubborn dried-on food remnants. Recommended setting when using organic or ecological detergents containing low levels of active agents. Energy and water consumption are adjusted accordingly. |

¹ Depending on the appliance specifications

Installation and connection

Scope of supply

After unpacking all parts, check for any damage in transit and completeness of the delivery.

If you have any complaints, contact the dealer who sold you the appliance or our Customer Service.

Note: The appliance was tested at the factory to check it is in working order. It is possible that water has left marks on the appliance. These marks will disappear after the first wash cycle.

The delivery consists of the following:

- Dishwasher
- Instruction manual
- Installation instructions
- Warranty¹
- Installation material
- Steam guard plate¹
- Rubber apron¹
- Mains cable
- Quick reference guide¹

Installing and connecting the appliance

You can position your built-under or integrable appliance in a fitted kitchen between wooden and plastic walls. If you subsequently install your dishwasher as a free-standing appliance, you must stop it from tipping over, e.g. by screwing it to the wall or installing it under a continuous worktop that is securely connected to adjacent cabinets.

1. "Follow the safety instructions."
→ *Page 4*

2. "Follow the instructions for electrical connection." → *Page 15*
3. Check the "Scope of supply" → *Page 14* and the condition of the appliance.
4. Consult the installation instructions for the installation dimensions required.
5. Make the appliance level using the height-adjustable feet.
Make sure that the appliance is standing on the floor securely.
6. "Install the drainage connection." → *Page 14*
7. "Install the drinking water connection." → *Page 15*
8. Connect the appliance to the power supply.

Drainage connection

Connect your appliance to drainage connection so dirty water is discharged via the wash cycle.

Installing the drainage connection

1. Consult the installation instructions supplied for the steps required here.
2. Connect the wastewater hose to the outlet connection of the siphon using the enclosed parts.
3. When doing so, check that the wastewater hose is not kinked, crushed or twisted.
4. Also check that there is no cover in the drainage system preventing the wastewater from being discharged.

¹ Depending on the appliance specifications

Drinking water connection

Connect your appliance to a drinking water connection.

Installing the drinking water connection

Note

- If you are replacing the appliance, you must use a new water supply hose.
1. Consult the installation instructions supplied for the steps required here.
 2. Connect the appliance to the drinking water connection using the enclosed parts.
Observe the "Technical data"
→ *Page 69*.
 3. When doing so, check that the drinking water connection is not kinked, crushed or twisted.

Electrical connection

Connect your appliance to the power supply.

Connecting the appliance to the electricity supply

Notes

- Follow the "Safety instructions"
→ *Page 5*.
 - Connect the appliance to alternating current only, in the range of 220 - 240 V and 50 Hz or 60 Hz.
 - Please note that the water safety system is only functional if there is a power supply.
1. Insert the non-heating appliance plug of the power cable into the appliance.
 2. Insert the mains plug of the appliance into a nearby socket.

The connection data for the appliance can be found on the rating plate.

3. Check that the mains plug is inserted properly.

Familiarising yourself with your appliance

Appliance

You can find an overview of the parts of your appliance here.

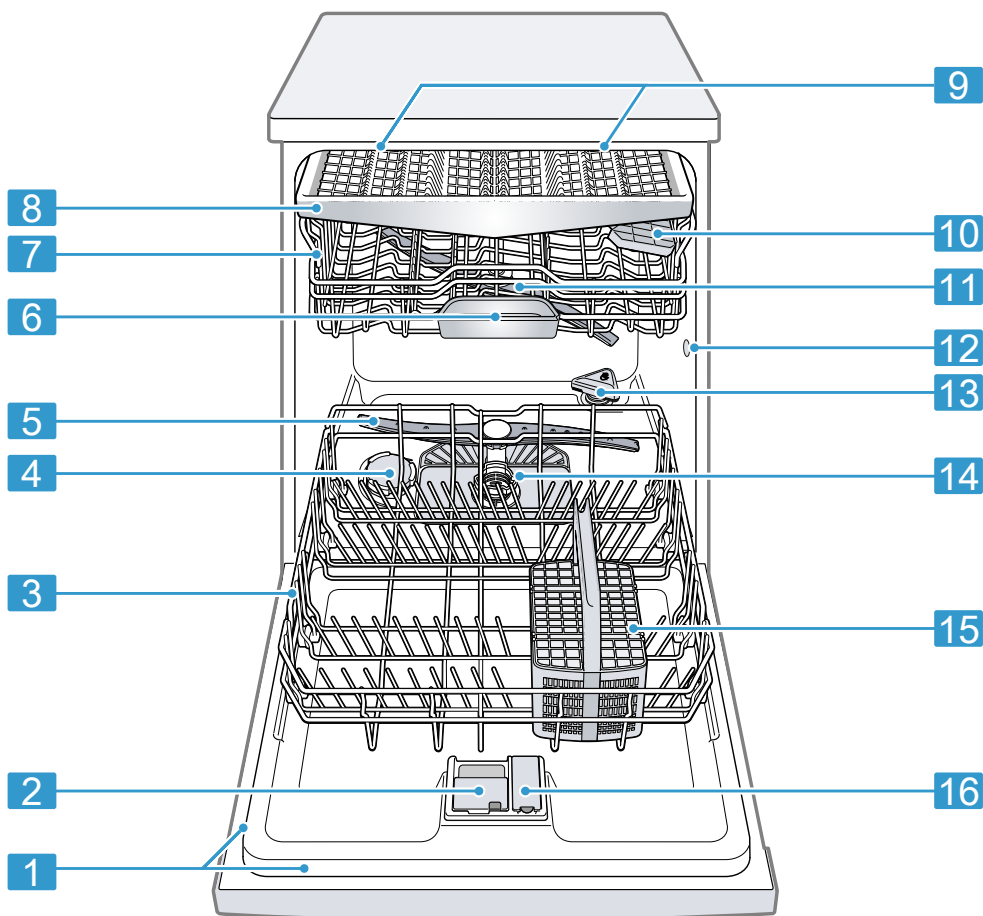

1

Rating plate

Rating plate with "E number and FD number"
→ Page 69.
The data you need for "Customer Service"
→ Page 68.

¹ Depending on the appliance specifications

| | | |
|-----------|---|---|
| 2 | Detergent dispenser | "Detergent" → <i>Page 36</i> is added to the detergent dispenser. |
| 3 | Bottom basket | "Bottom basket" → <i>Page 26</i> |
| 4 | Dispenser for special salt | Add special salt for the "Water softening system" → <i>Page 32</i> to the dispenser for special salt. |
| 5 | Lower spray arm | The lower spray arm washes the tableware in the bottom basket. If the tableware has not been washed properly, clean the spray arms. → <i>"Cleaning spray arms", Page 52</i> |
| 6 | Tablet collecting tray | During the wash cycle tablets automatically fall out of the detergent dispenser into the tablet collecting tray where they can fully dissolve. |
| 7 | Top basket | "Top basket" → <i>Page 24</i> |
| 8 | Cutlery drawer ¹ | "Cutlery drawer" → <i>Page 27</i> |
| 9 | EmotionLight ¹ | Interior lighting of the appliance. → <i>"Overview of basic settings", Page 43</i> |
| 10 | Etagere | "Etagere" → <i>Page 29</i> |
| 11 | Upper spray arm | The upper spray arm washes the tableware in the top basket. If the tableware has not been washed properly, clean the spray arms. → <i>"Cleaning spray arms", Page 52</i> |
| 12 | Intake opening of the Zeolith container | The intake opening is required for "Zeolith drying" → <i>Page 13</i> . |
| 13 | Blow opening of the Zeolith container | The blow opening is required for "Zeolith drying" → <i>Page 13</i> . |
| 14 | Filter system | "Filter system" → <i>Page 51</i> |
| 15 | Cutlery basket ¹ | "Cutlery basket" → <i>Page 27</i> |
| 16 | Dispenser for rinse aid | Add rinse aid for the "Rinse aid system" → <i>Page 35</i> to the dispenser for rinse aid. |

¹ Depending on the appliance specifications

Controls

The controls are used to configure all functions of your appliance and to obtain information about the operating status.

With some buttons you can perform different functions.

en Familiarising yourself with your appliance

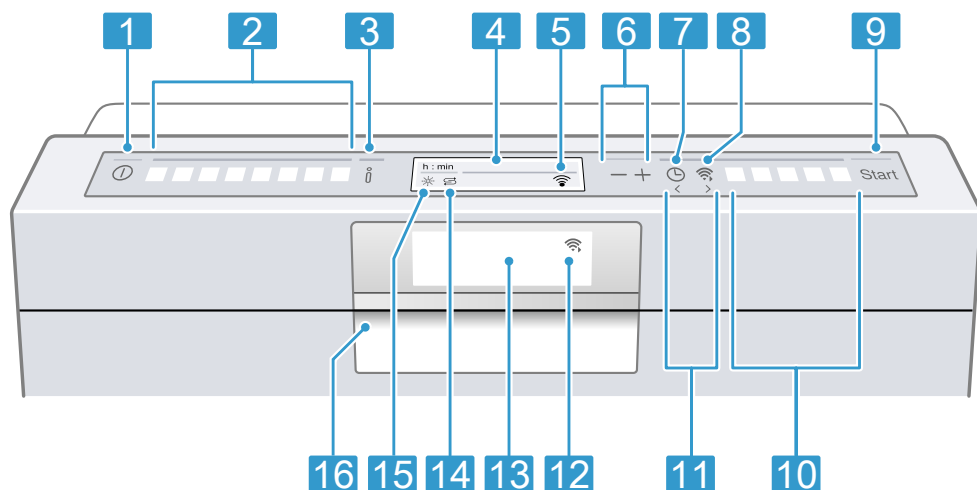

| | | |
|----|--|--|
| 1 | ON/OFF button | "Switching on the appliance" → Page 41 "Switching off the appliance" → Page 42 |
| 2 | Programme buttons | "Programmes" → Page 20 |
| 3 | Info button | If you press , the display shows information about selected programmes, basic settings and additional functions. If you press for approx. 3 seconds, you can open the menu. → "Changing basic settings", Page 45 |
| 4 | Display | The display shows information about programmes, basic settings or additional functions. You can change the basic settings via the display and the setting buttons. → "Changing basic settings", Page 45 |
| 5 | WLAN display | "Home Connect" → Page 45 |
| 6 | Setting buttons | "Changing basic settings" → Page 45 |
| 7 | Timer programming | "Setting timer programming" → Page 41 |
| 8 | Remote start button | "Remote start" → Page 48 |
| 9 | Start button Start and reset button Reset 3 sec. | "Starting the programme" → Page 42 "Terminating the programme" → Page 42 |
| 10 | Programme buttons and additional functions | "Programmes" → Page 20 "Additional functions" → Page 22 |

¹ Depending on the appliance specifications



| | | |
|-----------|-----------------------------------|---|
| 11 | <> buttons | You can use these buttons to scroll between the basic settings. → <i>"Changing basic settings", Page 45</i> |
| 12 | Remote start display ¹ | If you have activated the remote start button and are controlling the appliance via the Home Connect app, the remote start display lights up. |
| 13 | Display ¹ | The display shows information about programmes, basic settings or additional functions. You can change the basic settings via the display and the setting buttons. → <i>"Changing basic settings", Page 45</i> |
| 14 | Special salt refill indicator | "Water softening system" → <i>Page 32</i> |
| 15 | Rinse aid refill indicator | "Rinse aid system" → <i>Page 35</i> |
| 16 | Door opener ¹ | "Opening the appliance door" → <i>Page 41</i> |





¹ Depending on the appliance specifications





Programmes

You can find an overview of the programmes that can be selected here. Different programmes, which can be found on the control panel of your appliance, are available depending on the appliance configuration. The running time may vary depending on the programme selected. The running time depends on the water temperature, the quantity of dishes, the level of soiling and the "Additional function" → Page 22 selected. The

running time will change if the rinse aid system is switched off or rinse aid needs to be added. The consumption values can be found in the quick reference guide. The consumption values relate to normal conditions and a water hardness of 16 - 20 °E. Different influencing factors such as water temperature or pipe pressure may result in deviations.

| Programme | Use | Programme sequence | Additional functions |
|---|---|---|---|
|  <p>Intensive 70°</p> | <p>Tableware:</p> <ul style="list-style-type: none"> ■ Washing pots and pans, non-fragile tableware and cutlery. <p>Level of soiling:</p> <ul style="list-style-type: none"> ■ Removing stubborn burned or dried-on food remnants containing starch and protein. <p>When using powder detergent, you can also apply a little to the inside of the appliance door.</p> | <p>Intensive:</p> <ul style="list-style-type: none"> ■ PreRinse ■ Cleaning 70 °C ■ Intermediate rinse ■ Rinsing 50 °C ■ Drying | <p>All</p> <p>→ "Additional functions", Page 22</p> |
|  <p>Auto 45-65°</p> | <p>Tableware:</p> <ul style="list-style-type: none"> ■ Cleaning mixed tableware and cutlery. <p>Level of soiling:</p> <ul style="list-style-type: none"> ■ Removing common household food remnants lightly dried-on. | <p>Sensor-controlled:</p> <ul style="list-style-type: none"> ■ Optimised by sensors depending on the soiling of the washing water. | <p>All</p> <p>→ "Additional functions", Page 22</p> |

| Programme | Use | Programme sequence | Additional functions |
|---|--|--|--|
| <p>eco</p>  <p>Eco 50°</p> | <p>Tableware:</p> <ul style="list-style-type: none"> ■ Cleaning mixed tableware and cutlery. <p>Level of soiling:</p> <ul style="list-style-type: none"> ■ Removing common household food remnants lightly dried-on. | <p>Most economical programme:</p> <ul style="list-style-type: none"> ■ Pre-Rinse ■ Cleaning 50 °C ■ Intermediate rinse ■ Rinsing 35 °C ■ Drying | <p>All → "Additional functions", Page 22</p> |
| <p> Auto 65-75°</p> | <p>Tableware:</p> <ul style="list-style-type: none"> ■ Washing pots and pans, non-fragile tableware and cutlery. <p>Level of soiling:</p> <ul style="list-style-type: none"> ■ Removing stubborn burned or dried-on food remnants containing starch and protein. | <p>Sensor-controlled:</p> <ul style="list-style-type: none"> ■ Optimised by sensors depending on the soiling of the washing water. | <p>All → "Additional functions", Page 22</p> |
| <p> Auto 35-45°</p> | <p>Tableware:</p> <ul style="list-style-type: none"> ■ Washing pots and pans, non-fragile tableware and cutlery. <p>Level of soiling:</p> <ul style="list-style-type: none"> ■ Removing stubborn burned or dried-on food remnants containing starch and protein. | <p>Sensor-controlled:</p> <ul style="list-style-type: none"> ■ Optimised by sensors depending on the soiling of the washing water. | <p>IntensiveZone Power Improved drying → "Additional functions", Page 22</p> |
| <p> NightProgram</p> | <p>Tableware:</p> <ul style="list-style-type: none"> ■ Cleaning mixed tableware and cutlery. <p>Level of soiling:</p> <ul style="list-style-type: none"> ■ Removing common household food remnants lightly dried-on. | <p>Reduced noise:</p> <ul style="list-style-type: none"> ■ PreRinse ■ Cleaning 50 °C ■ Intermediate rinse ■ Rinsing 35 °C ■ Drying | <p>IntensiveZone Half Load Improved drying HygienePlus → "Additional functions", Page 22</p> |

| Programme | Use | Programme sequence | Additional functions |
|---|--|--|---|
|  Glass 40° | Tableware: <ul style="list-style-type: none"> ■ Cleaning delicate tableware, cutlery, temperature-sensitive plastics, glasses and stemware in the stemware basket. Level of soiling: <ul style="list-style-type: none"> ■ Removing lightly adhering fresh food remnants. | Particularly gentle: <ul style="list-style-type: none"> ■ PreRinse ■ Cleaning 40 °C ■ Intermediate rinse ■ Rinsing 50 °C ■ Drying | IntensiveZone Power Half Load Improved drying → "Additional functions", Page 22 |
|  Quick 45° | Tableware: <ul style="list-style-type: none"> ■ Cleaning delicate tableware, cutlery, temperature-sensitive plastics and glasses. Level of soiling: <ul style="list-style-type: none"> ■ Removing lightly adhering fresh food remnants. | Time-optimised: <ul style="list-style-type: none"> ■ Cleaning 45 °C ■ Intermediate rinse ■ Rinsing 50 °C | Improved drying → "Additional functions", Page 22 |
|  PreRinse | Tableware: <ul style="list-style-type: none"> ■ Cleaning all types of tableware. Level of soiling: <ul style="list-style-type: none"> ■ Cold rinsing, intermediate cleaning. | Cold rinse suitable: <ul style="list-style-type: none"> ■ Pre-Rinse | None |
|  Machine Care | - | Machine Care 70 °C | None |

Information for test institutes

Test institutes are provided with information for comparability tests, e.g. according to EN60436.



These are the conditions for conducting the tests, however they are not the results or consumption values. E-mail enquiries to: dishwasher@test-appliances.com



The product number (E-Nr.) and the production number (FD) are required here. They can be found on the rating plate on the appliance door.

Additional functions

You can find an overview of the additional functions that can be selected here. Different additional functions, which can be found on the control panel of your appliance, are available depending on the appliance configuration.

| Additional function | Use |
|---|---|
|  | <ul style="list-style-type: none"> ■ Switch on with small loads. |

| Additional function | Use |
|---|--|
| Half Load | <ul style="list-style-type: none"> It is recommended adding less detergent to the detergent dispenser than for a full machine load. The running time is shortened. Energy and water consumption are reduced. |
|  HygienePlus | <ul style="list-style-type: none"> To ensure a higher hygiene status for the appliance and dishes, the temperature is raised and maintained for an extra-long period. Especially suitable for cleaning chopping boards or baby bottles. Continuous use of this function increases the hygiene status. This will increase the running time and energy consumption. |
|  IntensiveZone | <ul style="list-style-type: none"> Switch on with mixed loads containing tableware with different soiling levels, e.g. place very soiled pots and pans in the bottom basket and normally soiled tableware in the top basket. The spray pressure in the bottom basket is increased and the maximum programme temperature held longer. This will increase the running time and energy consumption. |

| Additional function | Use |
|--|---|
|  Improved drying | <ul style="list-style-type: none"> For a better drying result the final rinse temperature is increased and the drying phase extended. Especially suitable for drying plastic parts. There is a slight increase in energy consumption and the running time is extended. |
|  Power | <ul style="list-style-type: none"> The running time is shortened by 20% to 66% depending on the washing programme. Energy and water consumption are increased. |

Features

You can find an overview of the possible features of your appliance and how to use them here. These features depend on the model of your appliance.

Top basket

Arrange cups and glasses in the top basket.

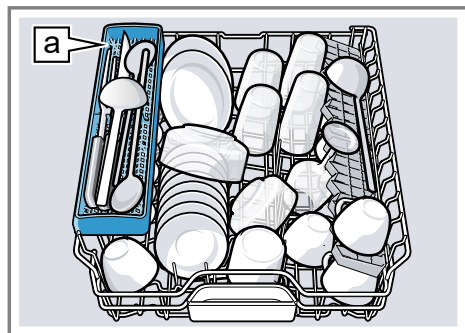

Knife shelf [a]¹

You can adjust the height of the top basket to make room for larger items of tableware.

Adjusting top basket with side levers

To wash large items of tableware in the baskets, adjust the shelf position of the top basket.

1. Pull out the top basket.
2. To prevent the basket from suddenly dropping down, hold the side of the basket by the top edge.

3. Press in the levers on the right and left on the outside of the basket.

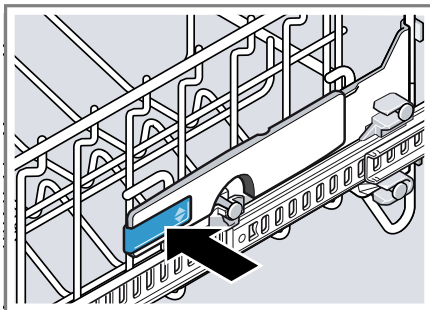

The basket can then slip down slightly.

4. Raise or lower the basket evenly to the right level.
→ "Basket heights", Page 31

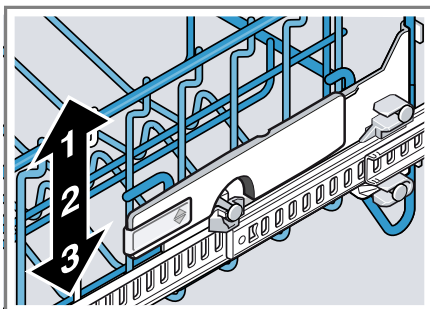

Check that the basket is level on both sides.

5. Slide the basket back in.

Removing the top basket

1. Pull the top basket right out ①.

¹ Depending on the appliance specifications

- Lift the basket forwards out of the catches ②.

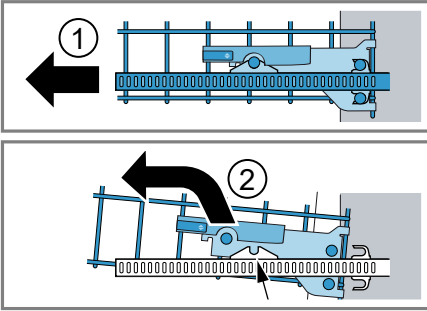

- Lower the basket and pull out.

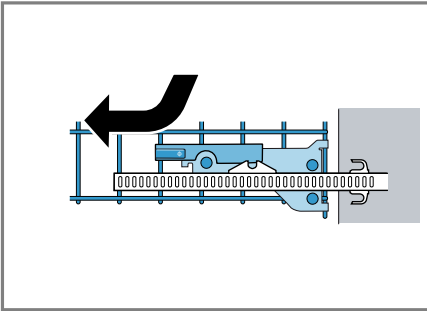

- Slide the guide rails into the appliance.

Installing the top basket

- Pull the guide rails of the top basket out of the appliance ①.
- Insert the top basket ②.

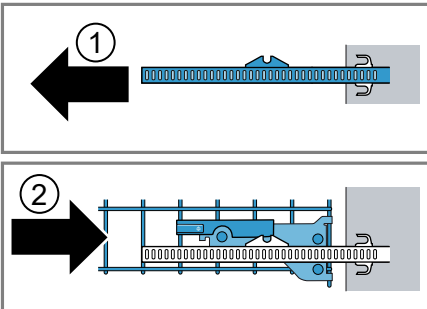

Observe the position of the detent pins.

- Lift the basket slightly and guide the rear detent pins into the rear locking hooks of the guide rails ①.
- Lower the basket and press the front detent pins into the notches ②.
- The basket clicks into position.
- Slide the basket back into the appliance ③.

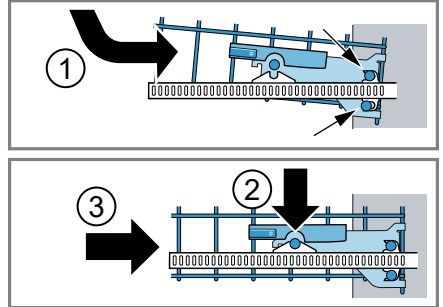

Bottom basket

Arrange pans and plates in the bottom basket.

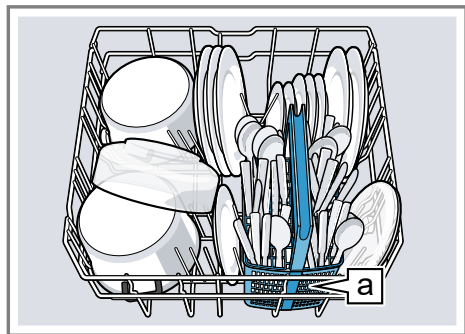

Cutlery basket **a**¹

Large plates up to a diameter of 31/34 cm¹ can be arranged as shown.

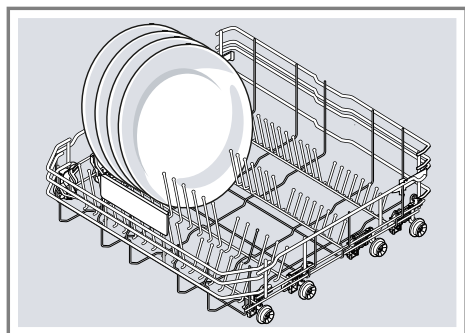

Removing the bottom basket

1. Pull the bottom basket right out.

2. Lift the basket out of the front holders and pull forwards slightly.

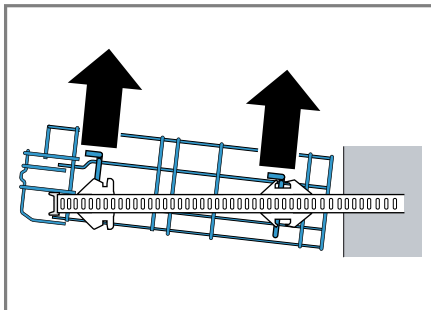

3. Lift the basket out of the rear holders.
4. Slide the guide rails into the appliance.

Installing the bottom basket

1. Pull the guide rails of the bottom basket out of the appliance.
2. Insert the bottom basket into the rear holders and slide back slightly ^①.
3. Lower the basket and insert into the front holders ^②.

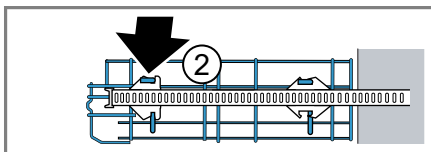
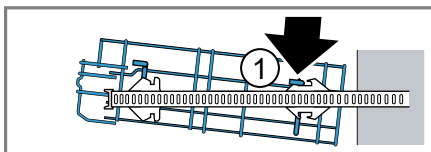

4. Slide the basket back into the appliance.

¹ Depending on the appliance specifications

Cutlery basket

Arrange cutlery in the cutlery basket, always without sorting it and with the sharp points downwards.

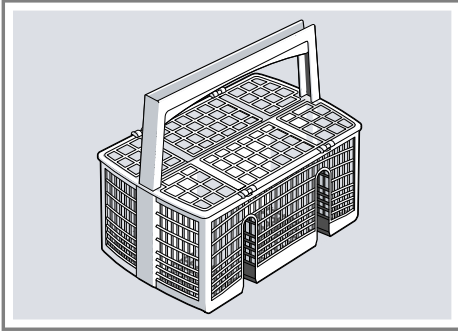

1. To fold down a side shelf, push the lever forwards ① and fold down the side shelf ②.
2. To fold down the front prongs, push the lever forwards and fold down the prongs ③.

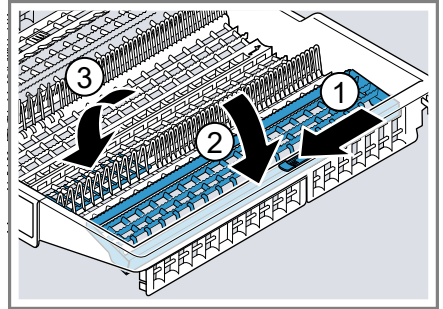

Cutlery drawer

Arrange cutlery in the cutlery drawer.

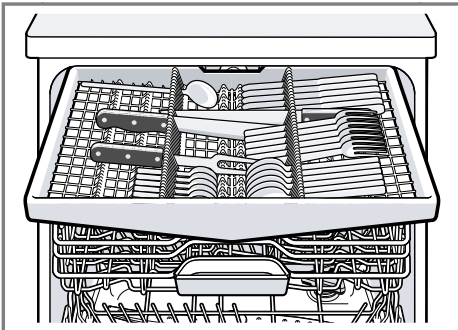

Arrange cutlery with the points and sharp edges downwards. You can reorganise the cutlery drawer to make more space for longer/wider items of cutlery.¹

Reorganising cutlery drawer¹

You can fold down the side shelves and front prongs to make more space for longer/wider items of cutlery.

Tip

If you want to return the cutlery drawer to the original position, fold the side shelf back up until it clicks into position.

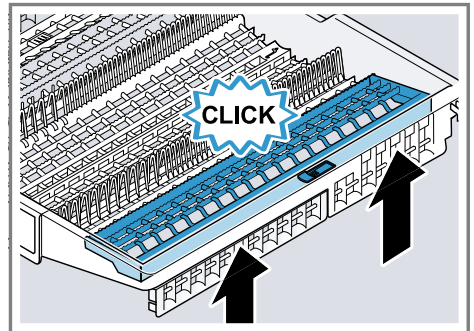

Removing cutlery drawer

1. Pull the cutlery drawer right out ①.

¹ Depending on the appliance specifications

en Features

2. Lift the cutlery drawer forwards out of the catches ②.

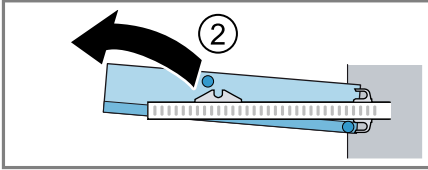
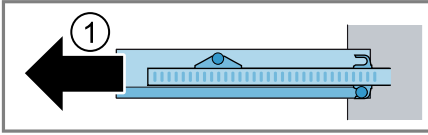

3. Lower the cutlery drawer and pull out.

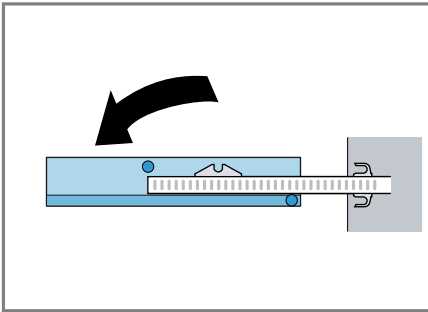

4. Slide the guide rails into the appliance.

Installing cutlery drawer

1. Pull the guide rails of the cutlery drawer out of the appliance ①.

2. Insert the cutlery drawer ②.

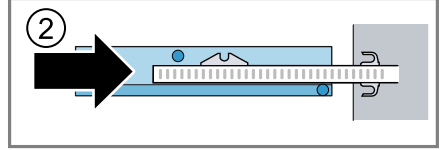
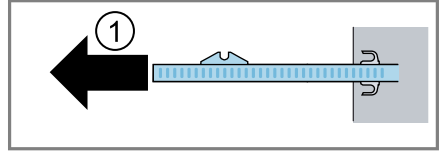

Observe the position of the detent pins.

3. Lift the cutlery drawer slightly and guide the lower detent pins into the lower locking hooks of the guide rails ①.
 4. Lower the cutlery drawer and press the front detent pins into the notches ②.
- ✓ The cutlery drawer clicks into position.
5. Slide the cutlery drawer into the appliance ③.

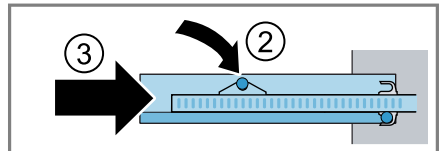
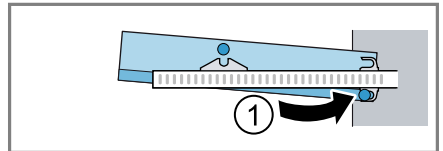

Etagere

Use the etagere and space underneath for small cups and glasses or for large items of cutlery, e.g. wooden spoons or serving cutlery.

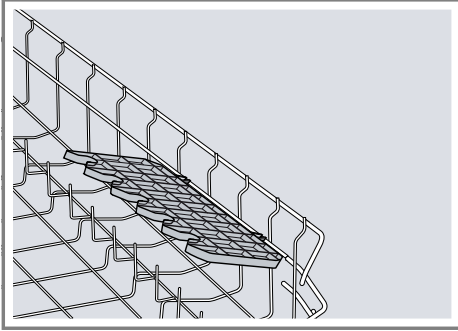

You can adjust the height of the etagere.¹

If you do not need the etagere, you can fold it up.

Adjusting etagere¹

You can adjust the height of the etagere.

1. Position the etagere vertically and pull it upwards ①.

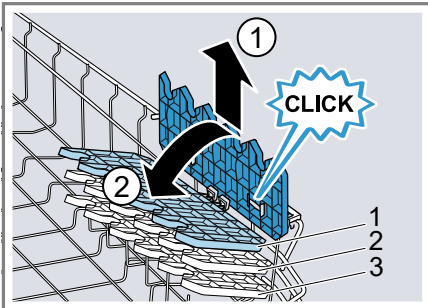

2. Position the etagere at a slight angle and move to the right height ②.
3. Push the etagere down.
 - ✓ The etagere clicks into position.

Folding prongs

Use the folding prongs to position tableware securely, e.g. plates.

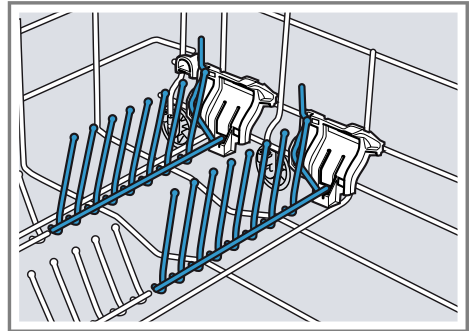

You can fold the prongs down to position pans, bowls and glasses better.¹

Folding down prongs¹

If you do not need the prongs, fold them down.

1. Push the lever forwards ① and fold down the prongs ②.

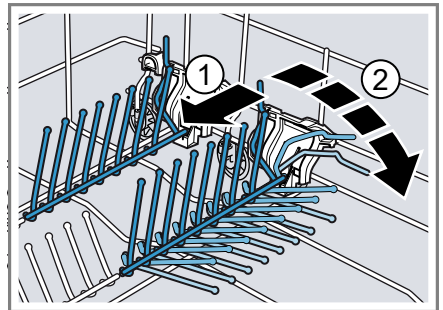

2. To use the folding prongs again, fold them back up.
 - ✓ The folding prongs click in position.

¹ Depending on the appliance specifications

Small items holder

Use the small items holder to position small items of tableware, e.g. light plastic parts.

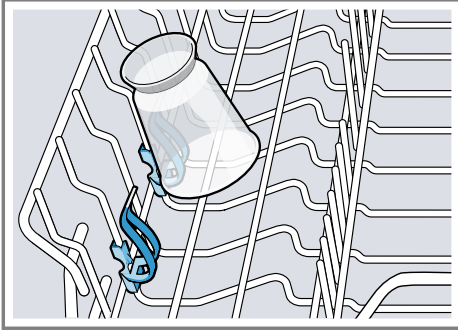

Knife shelf

Use the knife shelf for long, sharp objects and long items of cutlery.

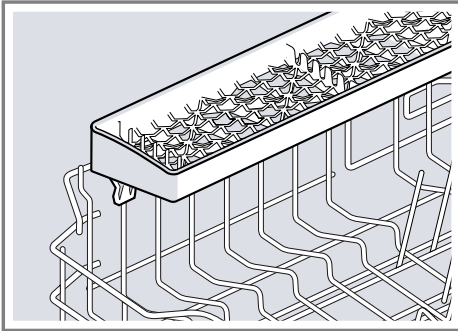

Baking sheet spray head

Use the baking sheet spray head to clean large items of tableware, e.g. trays, grilles and plates.

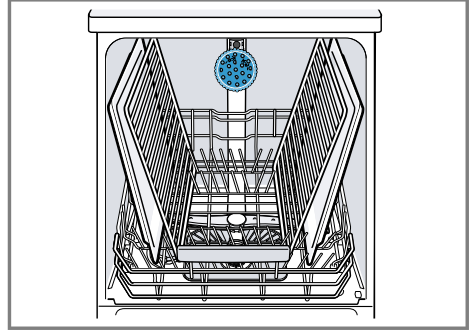

Arrange max. 2 baking sheets and 2 grilles as shown to ensure that the spray jet can reach all parts.

Note: Check that the appliance is always operated with the top basket or the baking sheet spray head.

Inserting baking sheet spray head

Use the baking sheet spray head instead of the top basket to clean large trays, grilles and plates.

1. "Remove top basket." → *Page 24*
2. Insert the baking sheet spray head in the holder ① and turn to the right ②.

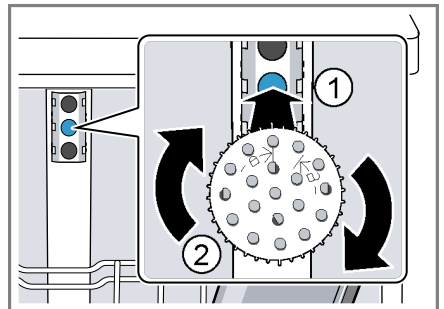

- ✓ The baking sheet spray head clicks into position.

Removing baking sheet spray head

If you no longer require the baking sheet spray head, remove it from the appliance.

1. Turn the baking sheet spray head anticlockwise and remove from the holder.
2. "Insert the top basket in the appliance." → *Page 25*

Basket heights

Set the baskets at the right height.

Appliance height 81.5 cm with cutlery basket

| Level | Top basket | Bottom basket |
|----------|------------|---------------|
| 1 max. ø | 22 cm | 31 cm |
| 2 max. ø | 24.5 cm | 27.5 cm |
| 3 max. ø | 27 cm | 25 cm |

Appliance height 81.5 cm with cutlery drawer

| Level | Top basket | Bottom basket |
|----------|------------|---------------|
| 1 max. ø | 16 cm | 31 cm |
| 2 max. ø | 18.5 cm | 27.5 cm |
| 3 max. ø | 21 cm | 25 cm |

Appliance height 86.5 cm with cutlery basket

| Level | Top basket | Bottom basket |
|----------|------------|---------------|
| 1 max. ø | 24 cm | 34 cm |
| 2 max. ø | 26.5 cm | 30.5 cm |
| 3 max. ø | 29 cm | 28 cm |

Appliance height 86.5 cm with cutlery drawer

| Level | Top basket | Bottom basket |
|----------|------------|---------------|
| 1 max. ø | 18 cm | 34 cm |
| 2 max. ø | 20.5 cm | 30.5 cm |
| 3 max. ø | 23 cm | 28 cm |

en Before using for the first time

Before using for the first time

Configure the settings for initial start-up.

Performing initial start-up

On initial start-up or after a reset to the factory settings, you will need to make settings.

Requirement: "The appliance has been installed and connected."
→ *Page 14*

1. "Add special salt." → *Page 33*
2. "Add rinse aid." → *Page 35*
3. Switch on the appliance.
✓ The display shows the settings for initial start-up.
4. Press > repeatedly until the display shows the required setting.

Note: If you select Initial start-up Home Connect here, make further settings using the Home Connect app on your mobile device.

- Language
- Initial start-up

- Time format
- Time setting
- Water hardness
- Rinse aid disp.
- Water connection¹

You can change these settings and other "Basic settings" → *Page 43* on the appliance at any time or using the Home Connect app on your mobile device.

5. Press — or + repeatedly until the display shows the right value.
You can change several settings.
6. To save the settings, press  for approx. 3 seconds.

Water softening system

Hard water leaves limescale on the tub and tableware and parts of the appliance may become blocked. To ensure good dishwashing results, you can treat the water with special salt and the water softening system. To avoid damage to the appliance, water with a hardness above 9 °E must be softened.

Overview of water hardness settings

You can find an overview of the water hardness values that can be selected here.

You can find out how hard your water is from your local water company or by using a water hardness tester.

| Water hardness °E | Hardness range | mmol/l | Setting value |
|-------------------|----------------|-----------|---------------|
| 0 - 8 | Soft | 0 - 1.1 | 0 - 8 |
| 9 - 10 | Soft | 1.2 - 1.4 | 9 - 10 |
| 11 - 12 | Medium | 1.5 - 1.8 | 11 - 12 |
| 13 - 15 | Medium | 1.9 - 2.1 | 13 - 15 |
| 16 - 20 | Medium | 2.2 - 2.9 | 16 - 20 |
| 21 - 26 | Hard | 3.0 - 3.7 | 21 - 26 |

¹ Depending on the appliance specifications

| Water hardness °E | Hardness range | mmol/l | Setting value |
|-------------------|----------------|-----------|---------------|
| 27 - 38 | Hard | 3.8 - 5.4 | 27 - 38 |
| 39 - 62 | Hard | 5.5 - 8.9 | 39 - 62 |

Note: Set the water hardness determined on your appliance.



→ *"Setting water softening system", Page 33*

With a water hardness of 0 - 8 °E you can dispense with special salt and switch off the water softening system.

→ *"Switching off water softening system", Page 34*

Setting water softening system

Set the water hardness on your appliance.

1. Determine the water hardness and the appropriate setting value.
→ *"Overview of water hardness settings", Page 32*
2. To open the basic settings, press  for approx. 3 seconds.
3. Press > repeatedly until the display shows "Water hardness".
4. Press — or + repeatedly until the display shows the right water hardness value.
5. To save the settings, press  for approx. 3 seconds.

Special salt

You can use special salt to soften water.

Adding special salt

If the special salt refill indicator lights up, add special salt to the dispenser for special salt just before the programme starts. The amount of special salt required depends on the wa-

ter hardness: the higher the water hardness, the greater the amount of special salt required.

ATTENTION!

- Detergent may damage the water softening system.
 - ▶ Only fill the dispenser of the water softening system with special dishwasher salt.
 - Special salt can damage the tub due to corrosion.
 - ▶ To make sure that any special salt that escapes is washed out of the tub, add the special salt to the dispenser for special salt immediately before the programme starts.
1. Unscrew the lid of the dispenser for special salt and remove.
 2. On initial start-up: Fill the dispenser right up with water.

en Water softening system

- 3. Note:** Only use special salt for dishwashers.

Do not use salt tablets.

Do not use table salt.

Add the special salt to the dispenser.

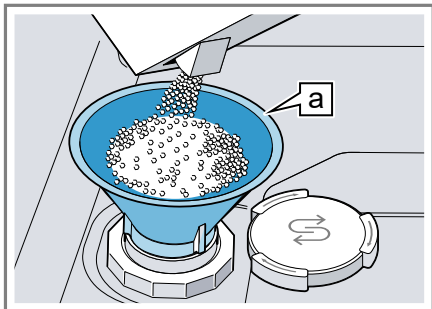

Funnel [a]¹

Fill the dispenser right up with special salt. The water in the dispenser is displaced and forced out.

- 4.** Place the lid back on the dispenser and turn to close.

Switching off water softening system



If you find the special salt refill indicator irritating, e.g. when using combined detergents with salt replacement substances, you can switch the salt refill indicator off.

Note

To avoid damage to the appliance, only switch off the water softening system in the following cases:

- The water hardness is max. 26 °E and you are using combined detergents with salt replacement substances. According to manufacturers, combined detergents with salt replacement substances can gen-

erally only be used up to a water hardness of 26 °E without adding special salt.

- The water hardness is 0 - 8 °E. You do not need to use special salt.
1. To open the basic settings, press  for approx. 3 seconds.
 2. Press > repeatedly until the display shows "Water hardness".
 3. Press - or + repeatedly until the display shows 0 - 6.
 4. To save the settings, press  for approx. 3 seconds.
- ✓ The water softening system is switched off and the salt refill indicator is deactivated.

Regeneration of the water softening system

In order to obtain fault-free function of the water softening system, the appliance performs reheating of the water softening system at regular intervals. Regeneration of the water softening system takes place before the end of the main rinse cycle in all programmes. It will increase the run time and consumption values, e.g. water and electricity.

¹ Depending on the appliance specifications

Overview of consumption values with regeneration the water softening system

Here you can find an overview of the maximum additional running time and consumption values during regeneration of the water softening system. You can find the column applicable to your model in the quick reference guide according to its water consumption in the Eco 50° programme.

| Water consumption in litres (depending on model) | Regeneration of the water softening system after x rinse cycles | Additional running time in minutes | Additional water consumption in litres | Additional power consumption in kWh |
|--|---|------------------------------------|--|-------------------------------------|
| 6.5 / 6.7 | 8 | 7 | 5 | 0.05 |
| 7.5 / 7.7 | 7 | 7 | 5 | 0.05 |
| 9.5 | 6 | 7 | 5 | 0.05 |
| above 10.5 | 5 | 7 | 5 | 0.05 |

The consumption values specified are laboratory measurements determined in accordance with the currently applicable standard and using the Eco 50° programme and the factory value of the water hardness is set to 16 - 20°E.

Rinse aid system

You can use the rinse aid system and rinse aid to get tableware and glasses rinsed perfectly without marks.

Rinse aid

For optimum drying results, use rinse aid.

Only use rinse aid for domestic dishwashers.

Adding rinse aid

If the display shows "Please add rinse aid.", add rinse aid. Only use rinse aid for domestic dishwashers.

1. Press the catch on the lid of the dispenser for rinse aid ① and lift ②.

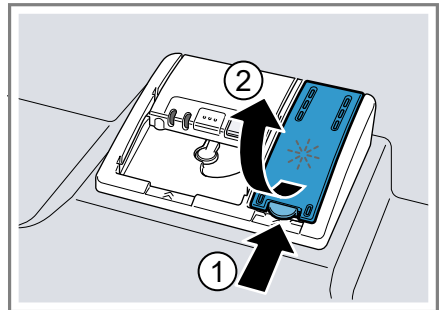

2. Add rinse aid up to the max mark.

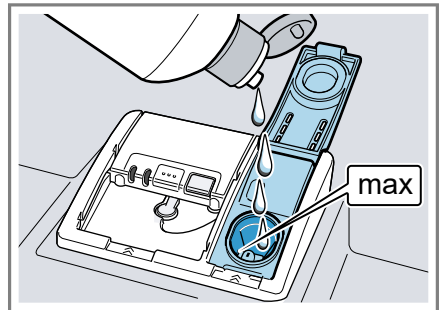

3. If rinse aid spills out, remove it from the tub.

en Detergent

Spilled rinse aid can cause excessive frothing during the wash cycle.

4. Close the lid of the dispenser for rinse aid.
- ✓ The lid clicks into position.

Setting the amount of rinse aid

If there are streaks or water marks on tableware, change the amount of rinse aid.

1. To open the basic settings, press  for approx. 3 seconds.
2. Press > repeatedly until the display shows "Rinse aid dispenser".
3. Press — or + repeatedly until the right amount of rinse aid has been set.

The value 5 is set at the factory.

- A low setting adds less rinse aid during the wash cycle and reduces streaking on tableware.
 - A higher setting adds more rinse aid during the wash cycle, reduces water marks and improves the drying result.
4. To save the settings, press  for approx. 3 seconds.

Switching rinse aid system off

If you find the rinse aid refill indicator irritating, e.g. when using combined detergents with a rinse aid component, you can switch the rinse aid system off.

Tip: The function of rinse aid is limited with combined detergents. You will generally get better results using rinse aid.

1. To open the basic settings, press  for approx. 3 seconds.
2. Press > repeatedly until the display shows "Rinse aid dispenser".

3. Press — or + repeatedly until the display shows the amount of rinse aid as 0.
 4. To save the settings, press  for approx. 3 seconds.
- ✓ The rinse aid system is switched off and the rinse aid refill indicator is deactivated.

Detergent

Find out which detergents are suitable for your appliance.

Suitable detergents

Only use detergents that are suitable for dishwashers. Both separate and combined detergents are suitable. For optimum washing and drying results, use separate detergent, adding "Special salt" → Page 33 and "Rinse aid" → Page 35 separately.

Modern, powerful detergents mainly use a low-alkaline formulation with enzymes. Enzymes break down starch and remove protein. Oxygen-based bleaching agents are generally used to remove coloured marks, e.g. tea or ketchup.

Note: Follow the manufacturer's instructions for each detergent.

| Detergent | Description |
|-----------|---|
| Tabs | Tabs are suitable for all cleaning functions and do not need to be measured out. With shorter Programmes tabs sometimes do not dissolve entirely and leave residues of detergent. This may impair the cleaning effect. |

| Detergent | Description |
|------------------|---|
| Powder detergent | Powder detergent is recommended for shorter Programmes. The dosage can be adjusted to the level of soiling. |
| Liquid detergent | Liquid detergent works faster and is recommended for shorter Programmes without PreRinse. Sometimes liquid detergent may leak out despite the detergent dispenser being closed. This is not a fault and is non-critical if you remember the following: <ul style="list-style-type: none"> ■ Only choose a programme without PreRinse. ■ Do not select timer programming for starting the programme. <p>The dosage can be adjusted to the level of soiling.</p> |

Tip: Suitable detergents are available online via our website or from "Customer Services" → *Page 68*.

Separate detergents

Separate detergents are products that do not contain components other than detergent, e.g. powder detergent or liquid detergent.

With powder and liquid detergent the dosage can be individually adjusted to the level of soiling of the tableware.

For better washing and drying results and to avoid damage to the appliance, please additionally use "Special salt" → *Page 33* and "Rinse aid" → *Page 35*.

Combined detergent

Besides conventional separate detergents, a number of products are available with additional functions. These products contain not only detergent but also rinse aid and salt replacement substances (3in1) and, depending on the combination (4in1, 5in1, ...), additional components such as glass protection or stainless steel cleaner.

According to manufacturers, combined detergents generally only function up to a water hardness of 26 °E. With a water hardness above 26 °E you will need to add special salt and rinse aid. For the best washing and drying results we recommend using special salt and rinse aid from a water hardness of 17 °E. If you are using combined detergent, the washing programme is adjusted automatically to ensure the best possible washing and drying result.

Unsuitable detergents

Do not use detergent which could cause damage to the appliance or present a risk to health.

| Detergent | Description |
|-------------------------------|---|
| Hand washing-up liquid | Hand washing-up liquid can cause increased frothing and damage the appliance. |
| Detergent containing chlorine | Chlorine residue on tableware may present a risk to health. |

Information on detergents

Follow the instructions on detergents in everyday use.

- Detergents marked as "organic" or "ecological" (environmentally friendly) generally contain lower levels of active agents or com-

en Detergent

pletely dispense with certain substances. The cleaning effect may be restricted here.

- Set the rinse aid and the water softening system to the separate detergent or combined detergent in use.
- According to manufacturers, combined detergents with salt replacement substances can only be used up to a certain water hardness, usually 26 °E, without adding special salt. For the best washing and drying results we recommend using special salt from a water hardness of 17 °E.
- To prevent sticking, only touch detergents in a water-soluble pouch with dry hands and only ever place them in a dry detergent dispenser.
- Even if the rinse aid and special salt refill indicators light up, washing programmes will run properly with combined detergents.
- The function of rinse aid is limited with combined detergents. You will generally get better results using rinse aid.
- Use tablets with a special drying performance.

Adding detergent

1. To open the detergent dispenser, press the locking latch.

2. Add the detergent to the dry detergent dispenser.

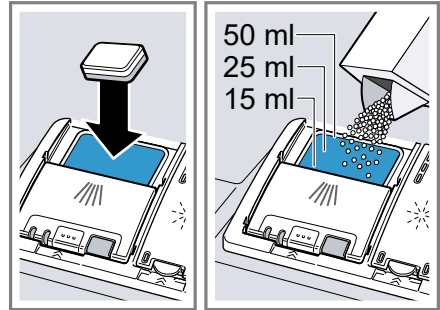

If you are using tablets, one is enough. Insert the tablets in a horizontal position.

If you are using powder or liquid detergent, follow the manufacturer's instructions and quantities for dosage in the detergent dispenser.

20 ml – 25 ml detergent is sufficient for normal soiling. If tableware is only lightly soiled, slightly less than the amount of detergent specified is usually sufficient.

3. Close the lid of the detergent dispenser.



- ✓ The lid clicks into position.
- ✓ The detergent dispenser will open automatically at the optimum time during the programme. Powder or liquid detergent will spread around the washing tank and dissolve there. Tablets will fall into the tablet collecting tray and dissolve in the right dosage. In order to ensure that tablets can dissolve evenly, do not place any other objects in the tablet collecting tray.

Tableware

Only clean tableware that is suitable for dishwashers.

Note: Decorated glassware and parts made of aluminium or silver may fade or discolour with dishwashing. Delicate types of glass may turn cloudy after a few washing cycles.

Damage to glass and tableware

Avoid damage to glass and tableware.

| Cause | Recommendation |
|---|--|
| <p>The following tableware is not dishwasher-safe:</p> <ul style="list-style-type: none"> ■ Items of cutlery and tableware made from wood ■ Decorated glassware, antique and hand-crafted tableware ■ Plastic parts not resistant to heat ■ Tableware made from copper or tin ■ Tableware soiled with ash, wax, lubricating grease or paint ■ Very small items of tableware | <p>Only put tableware in the dishwasher if it is marked as dishwasher-safe by the manufacturer.</p> |
| <p>Glass and tableware was not dishwasher-safe.</p> | <p>Only put glasses and china in the dishwasher if it is marked as dishwasher-safe by the manufacturer.</p> |
| <p>The chemical composition of the detergent causes damage.</p> | <p>Use a detergent marked as gentle on tableware by the manufacturer.</p> |
| <p>Highly caustic alkaline or highly acidic cleaning agents, in particular commercial or industrial cleaning agents, are not suitable for dishwashers in conjunction with aluminium.</p> | <p>If you are using highly caustic alkaline or highly acidic cleaning agents, in particular commercial or industrial cleaning agents, do not put aluminium parts in the dishwasher interior.</p> |

| Cause | Recommendation |
|---|--|
| The water temperature of the programme is too high. | Select a programme with lower temperatures. After the programme has ended, take glassware and cutlery out of the appliance without delay. |

Arrange tableware

Arrange the tableware correctly to optimise the dishwashing result and prevent damage to both the appliance and tableware.

Tips

- Using the appliance allows you to save energy and water compared to washing-up by hand.
- See our website for examples of how to load your appliance efficiently, free of charge.
- To save energy and water, load the machine with the number of place settings specified.
→ "Technical specifications", Page 69
- For better washing and drying results, position items with curves or recesses at an angle so the water can run off.

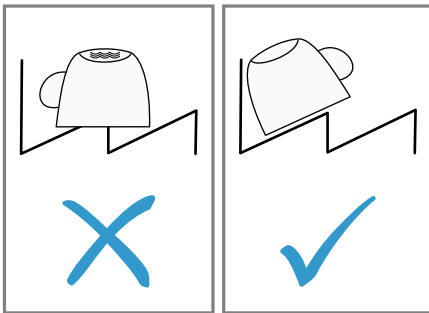

1. Remove large remnants of food from your tableware.

To save resources, do not pre-rinse tableware under running water.

2. Observe the following when arranging tableware:
 - Put heavily soiled tableware in the bottom basket, e.g. pans. The more powerful the spray jet, the better the dishwashing result will be.
 - To prevent damage to tableware, arrange it so it is stable and cannot tip over.
 - To prevent injury, arrange cutlery with the points and sharp edges downwards.
 - Position containers with the openings facing down so no water can collect in them.
 - Do not block the spray arms - make sure that they can turn freely.
 - Do not place small parts in the tablet collecting tray and do not block it with tableware so as not to obstruct the lid of the detergent dispenser.

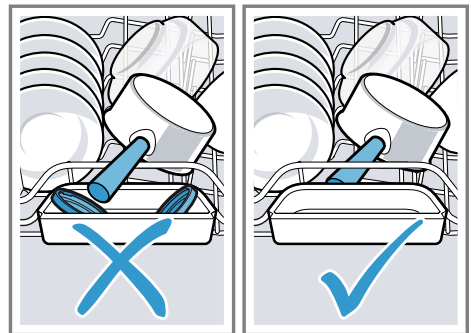

Removing tableware

WARNING **Risk of injury!**

Hot tableware can cause burns to the skin. When hot, tableware is sensitive to shock, may crack and can result in injury.

- ▶ When the programme has ended, do not empty the appliance until the tableware has cooled down for a while.
1. To prevent water dripping on the tableware, unload it starting at the bottom and working up.
 2. Check the washing tank and accessories for soiling and clean if necessary.
→ *"Cleaning and servicing"*, Page 50

Basic operation

Opening appliance door

1. If the electric childproof lock is not activated, press on the upper middle section of the appliance door.
 2. If the electric childproof lock is activated, press on the upper middle section of the appliance door twice with a short interval in between.
- ✓ The appliance door will open automatically.

Switching on the appliance

- ▶ Press .

The Eco 50° programme is set by default.

The Eco 50° programme is an especially environmentally friendly programme and ideal for normally soiled tableware. It is the most effi-

cient programme for the combination of energy/water consumption for this type of tableware and evidences conformity with the EU Eco-design Directive.

If you do not perform any actions on the appliance for 15 minutes, the appliance will automatically switch off.

Setting a programme

To adjust the wash cycle to the soiling level of the tableware, select a suitable programme.

- ▶ Press the right programme button.
→ *"Programmes"*, Page 20

Setting additional functions

You can set additional functions to complete the washing programme selected.

Note: The additional functions which can be used depend on the programme selected.

→ *"Programmes"*, Page 20

- ▶ Press the button for the relevant additional function.
→ *"Additional functions"*, Page 22
- ✓ The additional function is set and the additional function button flashes.

Setting timer programming

You can delay the start of the programme by up to 24 hours.

1. Press .
2. Press $-$ or $+$ repeatedly until the display shows the right time.

Depending on the setting of the time display, the end of the programme is shown on the display either with "Finish in" (e.g. 3h 25min) or "Finish at" (e.g.

en Basic operation

15:20 hours). You can change this setting in the "Basic settings"
→ *Page 43*.

3. To activate timer programming, press Start.

Tip: To deactivate timer programming, press Reset 3 sec. for approx. 3 seconds.

Starting the programme

- ▶ Press Start.
- ✓ The display shows the programme information.
- ✓ The programme has ended when the display shows "Finished!".

Notes

- If you want to add more tableware while the appliance is running, do not use the tablet collecting tray as a handle for the top basket. You might touch the partially dissolved tablet.
- You can only change a programme when running if you cancel it.
→ *"Terminate programme", Page 42*
- The appliance switches off automatically 1 minute after the end of the programme to save energy. If you open the appliance door immediately after the programme has ended, the appliance will switch off after 4 seconds.

Interrupting programme

Note: When you open the appliance door once the appliance has heated up, leave the door slightly ajar for a few minutes and then close it. This will help prevent excess pressure building up in the appliance and stop the appliance door bursting open.

1. Press ①.
- ✓ The programme is saved and the appliance switches off.
2. Press ① to resume the programme.

Terminate programme

To end a programme early or to switch from a programme that has already started, you will need to cancel it first.

1. Open the appliance door.
2. Press Reset 3 sec. for approx. 3 seconds.
- ✓ As soon as the displays are off, the display shows "Programme was terminated." and then "Finished!".
- ✓ The programme is cancelled and ends after approx. 1 minute.

Display programme information

You can show information about programmes and additional functions on the display.

1. Press .
2. Press the programme button or an additional function.

Switching off appliance

1. Please note the information on "Safe use" → *Page 11*.
2. Press ①.

Tip: If you press ① during the wash cycle, the programme currently running will be interrupted. When you switch the appliance back on, the programme continues automatically.

Basic settings

You can configure the appliance to meet your needs.

Overview of basic settings

The basic settings depend on the features of your appliance.

| Basic setting | Selection | Description |
|---------------------|--|---|
| Time setting | 00:00 - 24:00 | Set the current time. The setting depends on the time format selected. |
| Time format | 12 h 24 h ¹ | Set the time format. |
| Time display | In hours Time ¹ | Set the time display for the end of the programme. "Finish in" shows the remaining time the programme has to run, e.g. 3h 25min. "Finish at" shows the time when the programme will end, e.g. 15:20 hours. |
| Sprache/Language | See selection on the appliance. | Select the menu language. |
| Water hardness | 0 - 62 16 - 20 medium ¹ | Set the water hardness. → "Overview of water hardness settings", Page 32 |
| Rinse aid dispenser | 0 - 6 5 ¹ | Set or switch off the amount of rinse aid to be dispensed. → "Setting the amount of rinse aid", Page 36 |
| Sensor setting | Standard ¹ Sensitive Very sensitive | Set the water sensor for identifying soiling. → "Sensors", Page 13 |
| Extra Dry | on off ¹ | Switch "Extra Dry" on or off for each operation. The temperature is increased during the final rinse for a better drying result. This may increase the running time slightly. Please take care with delicate tableware. |
| Water connection | Cold water ¹ Hot water | Set cold water or hot water connection. Only set the appliance to hot water if this can be prepared with little energy and a suitable installation is available, e.g. solar heating system with circulation line. The water temperature should be at least 40 °C and max. 60 °C. |

¹ Factory setting (may vary according to model)



| Basic setting | Selection | Description |
|----------------------|--|---|
| Eco forecast | on off ¹ | Switch EcoCheck on or off. When selecting the programme, the average water consumption and energy consumption is briefly shown on the display. |
| Emotion Light | on ¹ off | Switch the interior lighting of the appliance on or off. The interior lighting switches on automatically when the appliance door is opened. When the appliance door is opened, the interior lighting switches off automatically after 15 minutes. |
| Front display | on ¹ off | Switch the front display on or off. |
| Remaining time proj. | on ¹ off | Switch "Remaining time proj." on or off. While the programme is running, status information is projected onto the floor below the appliance door, e.g. the remaining running time. If the base panel is pulled forwards or if the appliance is installed at eye level with the cabinet front fitted flush, the display is not visible. |
| Infolight | on ¹ off | Switch "Infolight" on or off. While the programme is running, a spot of light is projected onto the floor below the appliance door. This light will not be visible if the appliance is installed at eye level with the cabinet front fitted flush. If the appliance door is not completely closed, the spot of light will flash. The programme has ended when the spot of light is no longer visible on the floor. |
| Start programme | Eco 50°C ¹ Prog. last selected | Set a default programme for when the appliance is switched on. |
| Tone volume | Scale with multiple levels. | Set the signal volume at the end of the programme. Level 0 switches the signal tones off. |
| Button volume | Scale with multiple levels | Set the button volume during operation. Level 0 switches the button tones off. |
| Child-proof lock | on off ¹ | Switch the "Electric childproof lock" → <i>Page 12</i> on or off. |
| WLAN | on off ¹ | Switch the wireless network connection on or off. |

¹ Factory setting (may vary according to model)

| Basic setting | Selection | Description |
|-----------------|------------------------|---|
| Network login | Manual Autom./WPS | Log the appliance into the network. If your router has WPS, you can log your appliance into the network automatically. Only available if the basic setting "WLAN" is switched on. |
| Connect to app | Start with | Connect the appliance to a mobile device. Only available if the basic setting "WLAN" is switched on and the appliance is connected to the network. |
| Energy manager | Connect + | Connect the appliance to the energy manager of the home system. Only available if the appliance is connected to the network and the Home Connect app. |
| Greeting | on ¹ off | Switch display of the brand name logo on or off when the appliance is switched on. |
| Factory setting | Reset | Restore changed settings to the factory settings. The settings for initial start-up must be configured. |

¹ Factory setting (may vary according to model)

Changing basic settings

1. Open the appliance door.
2. Press .
3. To open the basic settings, press  for approx. 3 seconds.
4. Press \gt repeatedly until the display shows the required setting.
5. Press — or + repeatedly until the display shows the right value.
You can change several settings.
6. To save the settings, press  for approx. 3 seconds.

Setting the time

1. To open the basic settings, press  for approx. 3 seconds.
2. Press \gt repeatedly until the display shows "Time setting".
3. Press — or + repeatedly until the display shows the required time.

Holding down — and + will change the set values in 10-minute steps.

4. To save the settings, press  for approx. 3 seconds.

Home Connect

This appliance is network-capable. Connect your appliance to a mobile device to control its functions via the Home Connect app. Home Connect services are not available in every country. The availability of the Home Connect function depends on the availability of Home Connect services in your country. You can find information about this at: www.home-connect.com.

To be able to use Home Connect, you must first set up the connection to the WLAN home network (Wi-Fi¹) and to the Home Connect app.

There are various ways to connect to your home network, depending on the features of your appliance:

- → *"Automatically connecting appliance to WLAN home network (Wi-Fi)", Page 46*
- → *"Connecting appliance to WLAN home network (Wi-Fi) manually", Page 47*

The Home Connect app will guide you through the entire login process. Follow the instructions in the Home Connect app to configure the settings.

Tips

- Please consult the Home Connect documents supplied.
- Please also follow the instructions in the Home Connect app.

Note: Please note the safety precautions in this instruction manual and make sure that they are also observed when operating the appliance via the Home Connect app.

→ *"Safety", Page 4*

Installing app

1. Install the Home Connect app on your mobile device.
2. Start the app and set up access for Home Connect.

The Home Connect app will guide you through the entire login process.

Automatically connecting appliance to WLAN home network (Wi-Fi)

If your router has a WPS function, you can connect the appliance to your WLAN home network (Wi-Fi) automatically.

Requirements

- Wi-Fi on the router is activated.
- The appliance receives signals from the WLAN home network (Wi-Fi) at its installation location.
- Home Connect app is installed on your mobile device.

1. Press  on the appliance.
2. Follow the instructions on the display until the display shows "Press WPS button on your router within 2 minutes".
 - ✓ The appliance is ready for automatic connection to the WLAN home network (Wi-Fi) for 2 minutes.
3. Activate the WPS function on the router during this period.
 - ✓ If the appliance is connected to the WLAN home network (Wi-Fi), the display shows "Network login successful." and "Connect to app".
 - ✓ If the appliance is not connected to the WLAN home network (Wi-Fi), the display shows "Network login Failed".
4. If the display shows "Network login Failed", repeat the process.
5. Press + to connect the appliance to the app.
6. Follow the instructions in the app.
 - ✓ If the appliance is connected to the app, the display shows "Network login successful. ".

¹ Wi-Fi is a registered trademark of the Wi-Fi Alliance.

- ✓ If the appliance is not connected to the app, the display shows "Network login Failed".
- 7. If the appliance is not connected to the app, check that the mobile device is in the WLAN home network (Wi-Fi) and repeat the process.
- 8. To exit login, press +.

Connecting appliance to WLAN home network (Wi-Fi) manually

If your router does not have a WPS function, you can connect the appliance to your WLAN home network (Wi-Fi) manually.

Requirements

- Wi-Fi on the router is activated.
 - The basic setting "Wi-Fi" → *Page 44* is activated on the appliance.
 - The appliance receives signals from the WLAN home network (Wi-Fi) at its installation location.
 - Home Connect app is installed on your mobile device.
1. Start Home Connect app and follow the instructions.
 2. Press **i** on the appliance for approx. 3 seconds as soon as the app tells you to.
 3. Press > repeatedly until the display shows "Network login".
 4. Press — to start manual network login.
 - ✓ The appliance briefly sets up its own WLAN network.
 - ✓ The display shows "Network login Manual" and "SSID: HomeConnect", "Key = password".
 5. Confirm in the app and follow the instructions in the app.
 - ✓ It can take up to 1 minute to establish the connection.

- ✓ If the appliance is connected to the WLAN home network (Wi-Fi), the display shows "Network login successful. ".
- ✓ If the appliance is not connected to the WLAN home network (Wi-Fi), the display shows "Network login Failed".
- 6. If the display shows "Network login Failed", repeat the process.
- 7. Press +.
- ✓ The display shows "Connect to app".
- 8. Press + to connect the appliance to the app.
 - Follow the instructions in the app.
- ✓ If the appliance is connected to the app, the display shows "Network login successful. ".
- ✓ If the appliance is not connected to the app, the display shows "Network login Failed".
- 9. If the appliance is not connected to the app, check that the mobile device is in the WLAN home network (Wi-Fi) and repeat the process.
- 10. To exit login, press +.

Tip: Terminate login by pressing Reset 3 sec. for approx. 3 seconds.

Home Connect settings

Adapt Home Connect to your needs. You can find the Home Connect settings in the basic settings for your appliance. Which settings the display shows will depend on whether Home Connect has been set up and whether the appliance is connected to your home network.

Remote start

You can use the Home Connect app to start the appliance with your mobile device.

Tip: If you start operation on the appliance itself, remote start is automatically deactivated.

Activating remote start

Requirements

- "The appliance is connected to your WLAN home network."
→ Page 45
- The appliance is connected to the Home Connect app.
- "A programme has been set."
→ Page 41
- ▶ Press .
- ✓ The display shows "Remote start is activated."

Note: If you open the appliance door, remote start is automatically deactivated.

Deactivating remote start

Requirement: "Remote start is activated." → Page 48

- ▶ Press .
- ✓ The display shows "Remote start deactivated."

Remote Diagnostics

Customer Service can use Remote Diagnostics to access your appliance if you contact them, have your appliance connected to the Home Connect server and if Remote Diagnostics is available in the country in which you are using the appliance.

Tip: For further information and details about the availability of Remote Diagnostics in your country, please

visit the service/support section of your local website: www.home-connect.com

Energy manager

You can connect your appliance to the energy manager of your home system.

The energy management system will manage the power supply from your conventional and alternative energy sources, e.g. photovoltaic system. If your alternative energy sources produce sufficient energy within a preselected time, the energy manager will start the appliance. If your alternative energy sources do not produce sufficient energy, your appliance will start at the latest time possible within this preselected time using power from conventional energy sources.

Further information and the system requirements for using the energy manager can be found on the Home Connect website.

Connecting energy manager to home system

Requirements

- "The appliance is connected to your WLAN home network."
→ Page 45
 - The appliance is connected to the Home Connect app.
 - The connection to the energy management of your home system is activated. Follow the instruction manual of your home system.
1. To open the basic settings, press  for approx. 3 seconds.
 2. Press > repeatedly until the display shows "Energy manager".
 3. To start connection, press +.
 4. Connect the appliance to the energy management of your home system within the next 2 minutes.



- ✓ If the appliance is connected to the energy management of your home system, the display shows "Network login successful. "
- ✓ If the appliance is not connected to the energy management of your home system, the display shows "Network login Failed".
- 5. If the display shows "Network login Failed", press + again.
- 6. To close the basic settings, press  for approx. 3 seconds.

Activating energy manager

Requirements

- "The energy manager is connected to your home system." → *Page 48*
- "A programme has been set." → *Page 41*
- "You have preselected a time." → *Page 41*
- ▶ Press .
- ✓ The display shows "Flex ".
- ✓ The energy manager has access to the appliance and can start it during the preselected time.
- ✓ If the energy manager starts the appliance earlier, the time display "Finish in"/ "Finish at" will be updated.

Disconnecting energy manager from home system

1. To open the basic settings, press  for approx. 3 seconds.
2. Press > repeatedly until the display shows "Energy manager".
3. To disconnect, press +.
4. To close the basic settings, press  for approx. 3 seconds.

Data protection

Please see the information on data protection.

The first time your appliance is registered on a home network connected to the Internet, your

appliance will transmit the following types of data to the Home Connect server (initial registration):

- Unique appliance identification (consisting of appliance codes as well as the MAC address of the Wi-Fi communication module installed).
- Security certificate of the Wi-Fi communication module (to ensure a secure data connection).
- The current software and hardware version of your appliance.
- Status of any previous reset to factory settings.

This initial registration prepares the Home Connect functions for use and is only required when you want to use the Home Connect functions for the first time.

Note: Please note that the Home Connect functions can only be utilised with the Home Connect app. Information on data protection can be retrieved in the Home Connect app.

Declaration of Conformity

Gaggenau Hausgeräte GmbH hereby declares that the appliance with Home Connect functionality meets the essential requirements and other relevant provisions of the Directive 2014/53/EU.

A detailed RED Declaration of Conformity can be found online at www.gaggenau.com among the additional documents on the product page for your appliance.



2.4 GHz band: 100 mW max.
5 GHz band: 100 mW max.

| | | | | | | | | |
|--|----|----|----|----|----|----|----|----|
|  | BE | BG | CZ | DK | DE | EE | IE | EL |
| | ES | FR | HR | IT | CY | LV | LT | LU |
| | HU | MT | NL | AT | PL | PT | RO | SI |
| | SK | FI | SE | UK | NO | CH | TR | |

5 GHz WLAN (Wi-Fi): For indoor use only.

Cleaning and servicing

To keep your appliance working efficiently for a long time, it is important to clean and maintain it carefully.

Cleaning the tub

WARNING

Risk of harm to health!

Using detergents containing chlorine may result in harm to health.

- ▶ Never use detergents containing chlorine.

1. Remove any coarse soiling in the interior with a damp cloth.
2. Add detergent to the detergent dispenser.
3. Select the programme with the highest temperature.
→ "Programmes", Page 20
4. "Start the programme without tableware." → Page 42

Self-cleaning interior¹

To remove deposits, the appliance self-cleans the interior at regular intervals.

The programme sequence is automatically adjusted for self-cleaning, e.g. the cleaning temperature is briefly increased. Consumption values, e.g. water and electricity, may also increase.

If the interior is no longer self-cleaned adequately and deposits occur, see this information:

→ "Cleaning the tub", Page 50.

Cleaning products

Only use suitable cleaning products to clean your appliance.

→ "Safe use", Page 11

Tips on appliance care

Follow the tips on appliance care to make sure your appliance functions properly at all times.

| Action | Benefit |
|--|---|
| Wipe the door seals, the front of the dishwasher and the control panel regularly using a damp cloth and washing-up liquid. | This ensures the parts of the appliance will remain clean and hygienic. |
| If the appliance is not going to be used for a while, leave the door slightly ajar. | This will prevent unpleasant odours. |

Machine Care ¹

Deposits can cause your dishwasher to malfunction, e.g. due to grease or limescale. To avoid such faults and

¹ Depending on the appliance specifications

reduce odours, we recommend cleaning your appliance at regular intervals.

Machine Care combined with commercially available machine care products is the right programme for the care of your appliance. Run Machine Care without tableware if the indicator for Machine Care lights up on the control panel or if advised to do so by the display. Once you have run the Machine Care programme, the indicator goes out. If your appliance does not have a reminder function, follow the directions for use on the machine care products.

Performing Machine Care

Run the Machine Care programme if the indicator for Machine Care lights up on the control panel or if advised to do so by the display.

Notes

- Run the Machine Care programme without any tableware in the dishwasher.
- Only use suitable machine care products specially designed for dishwashers and not dishwasher detergent. Observe the manufacturer's instructions.
- Make sure that there are no aluminium parts in the interior of the appliance.
- If you have not run Machine Care after 3 washing cycles, the indicator for Machine Care will go out automatically.
- Follow the safety instructions and the directions for use on the packagings of the machine care products.

1. Remove any coarse soiling in the interior with a damp cloth.
2. Clean filters.

3. Add the machine care product to the appliance.
 4. Press .
 5. Press Start.
- ✓ The Machine Care programme is run.
 - ✓ As soon as machine care has finished, the indicator for Machine Care goes out.

Filter system

The filter system removes coarse soiling from the dishwashing cycle.

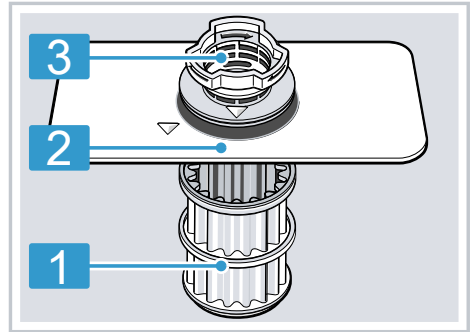

- | | |
|---|---------------|
| 1 | Micro filter |
| 2 | Fine filter |
| 3 | Coarse filter |

Cleaning filters

Soiling in the dishwashing water may block the filters.

1. After each wash check the filters for residue.

en Cleaning and servicing

2. Turn the coarse filter anticlockwise ① and remove the filter system ②.
 - Check that no foreign objects fall into the sump.

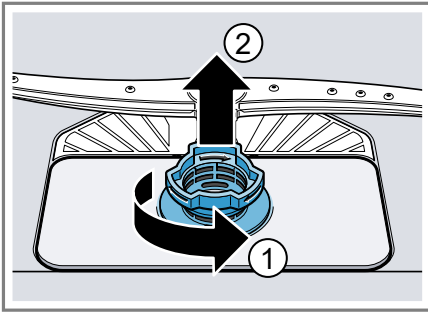

3. Pull down the micro filter to remove.

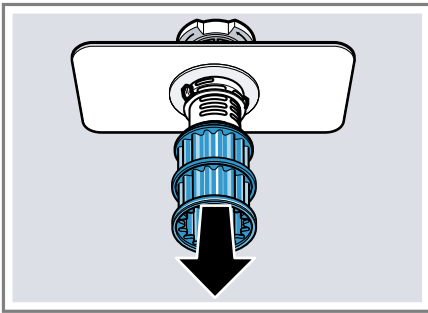

4. Press the locking catches ① together and lift the coarse filter out ②.

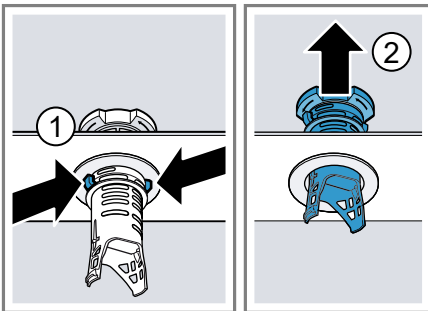

5. Clean the filter elements under running water.

Carefully clean the rim of dirt between the coarse and the fine filter.

6. Re-assemble the filter system. Make sure that the locking catches on the coarse filter click into position.
7. Insert the filter system into the appliance and turn the coarse filter clockwise. Make sure that the arrow markings match up.

Cleaning spray arms

Limescale and soiling in the dishwashing water may block the nozzles and bearings on the spray arms. Clean the spray arms regularly.

1. Unscrew the upper spray arm ① and pull down to remove ②.

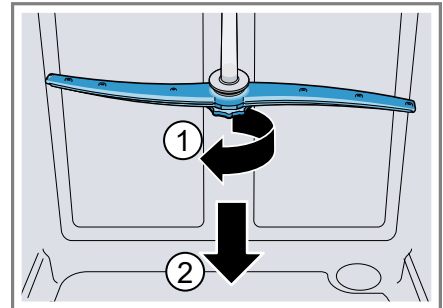

2. Pull up the lower spray arm to remove.

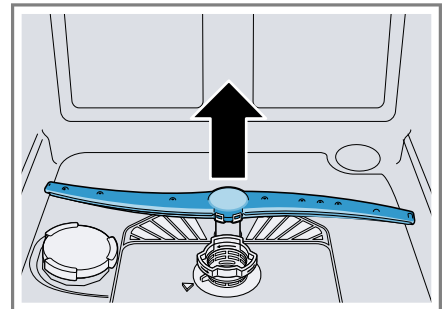

3. Check the outlet nozzles on the spray arms for blockages under running water and remove any foreign bodies.
4. Insert the lower spray arm.
 - ✓ The spray arm clicks into position.
5. Insert the upper spray arm and screw it firmly in place.

Troubleshooting

You can rectify minor faults on your appliance yourself. Read the troubleshooting information before contacting Customer Service. This will avoid unnecessary costs.

⚠ WARNING

Risk of electric shock!

Improper repairs are dangerous.

- ▶ Repairs to the appliance should only be carried out by trained specialist staff.
- ▶ Only use genuine spare parts when repairing the appliance.
- ▶ If the power cord of this appliance is damaged, it must be replaced with a special connection cable, which is available from the manufacturer or his Customer Service.

Appliance safety

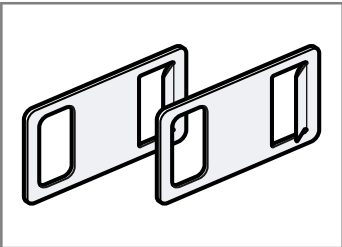
| Fault | Cause | Troubleshooting |
|--|---------------------------------|---|
| Appliance door will not open or cannot be opened easily. | Childproof lock is activated. | |
| Appliance door does not open. | Door is not correctly adjusted. | ▶ Adjust the appliance door as described in the installation instructions. |
| | Appliance has no power. | ▶ Check the mains plug and fuses. 1. Position the emergency release supplied on the top right and left of the cabinet panel. |
| | |  |
| | | 2. Open the appliance door by pulling lightly. |
| Appliance door and door seal are soiled. | | ▶ Clean the appliance door and door seal with a damp cloth and a little washing-up liquid. |
| Automatic door opening is not in home position. | | ▶ Wait one second after closing the appliance door. |



| Fault | Cause | Troubleshooting |
|---|---------------------------------|--|
| Appliance door opens too wide when activated. | Door is not correctly adjusted. | ▶ Adjust the appliance door as described in the installation instructions. |

Error code / Fault display / Signal

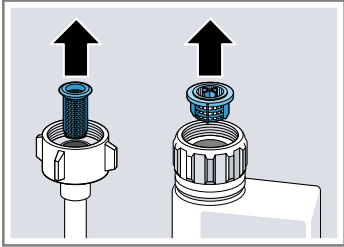
| Fault | Cause | Troubleshooting |
|---|---|---|
| E:07 lights up. | Intake opening of Zeolith container is covered by items of tableware. | ▶ Re-arrange the tableware in the appliance so the "Intake opening of the Zeolith container " → <i>Page 16</i> is no longer obstructed. |
| E:12 lights up. | Heating element is furred up. | 1. Descale the appliance. 2. Operate the appliance with the "Water softening system" → <i>Page 33</i> . |
| E:14 lights up. | Water protection system is activated. | 1. Turn off the water tap. 2. Call "Customer Service" → <i>Page 68</i> . |
| E:15 lights up. | Water protection system is activated. | 1. Turn off the water tap. 2. Call "Customer Service" → <i>Page 68</i> . |
| E:16 lights up. | Water is continuously running into the appliance. | 1. Turn off the water tap. 2. Call "Customer Service" → <i>Page 68</i> . |
| E:18 or indicator for water supply lights up. | Supply hose is kinked. | ▶ Install the supply hose without kinks. |
| | Water tap is turned off. | ▶ Turn on the water tap. |
| | Water tap is jammed or furred up. | ▶ Turn on the water tap. The flow rate must be at least 10 l/min when the water supply is open. |
| | Filter in the water supply is blocked. | 1. Switch off the appliance. 2. Pull out the mains plug. 3. Turn off the water tap. 4. Unscrew the water connection. |

| Fault | Cause | Troubleshooting |
|---|--|--|
| E:18 or indicator for water supply lights up. | | <ol style="list-style-type: none"> 5. Remove the filter from the supply hose |
| | |  |
| | | <ol style="list-style-type: none"> 6. Clean the filter. 7. Re-insert the filter in the supply hose. 8. Screw the water connection back on. 9. Check the water connection for leaks. 10. Restore the power supply. 11. Switch the appliance on. |
| E:22 lights up. ¹ | Filters are soiled or blocked. | <ul style="list-style-type: none"> ▶ Clean the filters. → "Cleaning filters", Page 51 |
| E:24 lights up. | Wastewater hose is blocked or kinked. | <ol style="list-style-type: none"> 1. Reposition the wastewater hose without kinks. 2. Remove residues. |
| | Siphon connection is still sealed. | <ul style="list-style-type: none"> ▶ Check the connection to the siphon and open if necessary. |
| | Cover of the wastewater pump is loose. | <ul style="list-style-type: none"> ▶ Secure the cover of the "Wastewater pump" → Page 67 so it clicks into position. |
| E:25 lights up. | Wastewater pump is blocked. | <ul style="list-style-type: none"> ▶ Clean the wastewater pump. → "Clean wastewater pump", Page 67 |
| | Cover of the wastewater pump is loose | <ul style="list-style-type: none"> ▶ Secure the cover of the "Wastewater pump" → Page 67 so it clicks into position. |

¹ Depending on the appliance specifications

| Fault | Cause | Troubleshooting |
|--|-------------------------------|--|
| E:27 lights up. | Mains voltage is too low. | This is not a fault on the appliance. <ol style="list-style-type: none"> 1. Contact an electrician. 2. Have the mains voltage and electrical installation checked by an electrician. |
| Another error code appears on the display. E:01 to E:30 | A technical fault is present. | <ol style="list-style-type: none"> 1. Press . 2. Unplug the appliance or switch off the fuse. 3. Wait at least 2 minutes. 4. Insert the mains plug of the appliance in a socket or switch on the fuse. 5. Switch the appliance on. 6. If the problem occurs again: <ul style="list-style-type: none"> - Press . - Turn off the water tap. - Pull out the mains plug. - Contact "Customer Service" → <i>Page 68</i> and give the error code. |

Washing results

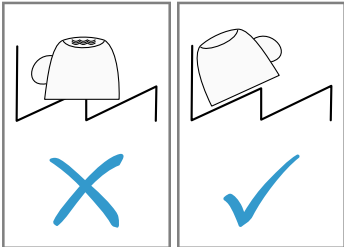
| Fault | Cause | Troubleshooting |
|-----------------------|---|--|
| Tableware is not dry. | No rinse aid used or dosage set too low. | <ol style="list-style-type: none"> 1. Add "Rinse aid" → <i>Page 35</i>. 2. Set the amount of rinse aid to be dispensed. → "<i>Setting the amount of rinse aid</i>", <i>Page 36</i> |
| | Selected programme has no drying phase | ▶ Select a programme with drying. |
| | Water collects in recesses of the tableware or cutlery. | ▶ Position tableware at an angle where possible. |
| | |  |

| Fault | Cause | Troubleshooting |
|--|--|--|
| Tableware is not dry. | The combined detergent used has a poor drying performance. | <ol style="list-style-type: none"> 1. Use rinse aid to improve drying performance. 2. Use a different combined detergent with a better drying performance. |
| | Extra Dry not activated to improve drying performance. | ▶ Activate "Extra Dry" → <i>Page 43</i> . |
| | Tableware removed too early or drying process not yet ended. | <ol style="list-style-type: none"> 1. Wait until the programme ends. 2. Only remove tableware 30 minutes after the programme has ended. |
| | Rinse aid used has a limited drying performance. | ▶ Use a name-brand rinse aid. Eco products may have limited effectiveness. |
| Plastic tableware is not dry. | Not a fault. As plastic does not store heat so well, it also does not dry as well. | ▶ No remedial action possible. |
| Cutlery is not dry. | Cutlery not arranged properly in the cutlery basket or cutlery drawer. | <ol style="list-style-type: none"> 1. Arrange the cutlery properly. → <i>"Arrange tableware", Page 40</i> 2. Arrange cutlery individually where possible. 3. Avoid points of contact. |
| Appliance interior still wet after wash cycle. | Not a fault. The condensation drying principle causes water droplets in the tub – they are indeed desirable here. The moisture in the air condenses on the inside walls, runs off and is pumped out. | No action required. |
| Remnants of food on tableware. | Tableware was placed too close together. | <ol style="list-style-type: none"> 1. Arrange tableware with sufficient space in between. The spray jets must reach the surfaces of the tableware. 2. Avoid points of contact. |
| | Basket is overfilled. | <ol style="list-style-type: none"> 1. Arrange tableware with sufficient space in between. The spray jets must reach the surfaces of the tableware. 2. Avoid points of contact. |
| | Spray arm rotation is blocked. | ▶ Arrange tableware so that it does not obstruct spray arm rotation. |

| Fault | Cause | Troubleshooting |
|------------------------------------|--|--|
| Remnants of food on tableware. | Spray arm nozzles are blocked. | ▶ Clean the "Spray arms" → <i>Page 52</i> . |
| | Filters are soiled. | ▶ Clean the filters. → <i>"Cleaning filters", Page 51</i> |
| | Filters are inserted incorrectly and/or not engaged. | <ol style="list-style-type: none"> 1. Insert the filters properly. → <i>"Filter system", Page 51</i> 2. Engage the filters. |
| | Washing programme selected too weak. | <ul style="list-style-type: none"> ▶ Select a more intensive washing programme. ▶ Adjust the sensitivity of the sensors. → <i>"Sensors", Page 13</i> |
| | Tableware has been pre-cleaned too intensely. The sensors chose a weaker programme. Stubborn soiling cannot be entirely removed. | <ul style="list-style-type: none"> ▶ Only remove large remnants of food and do not pre-rinse tableware. ▶ Adjust the sensitivity of the sensors. → <i>"Sensors", Page 13</i> |
| | Tall narrow receptacles in corner areas are not rinsed adequately. | ▶ Do not position tall narrow receptacles at too great an angle or in corner areas. |
| Detergent residue in the appliance | Top baskets on right and left are not set to same height. | ▶ Set the top baskets on the left and right to the same level. → <i>"Top basket", Page 24</i> |
| | Lid of the detergent dispenser is blocked by items of tableware parts and will not open. | <ol style="list-style-type: none"> 1. Arrange tableware in the top basket tableware so the tab collecting tray is not obstructed by tableware. → <i>"Arrange tableware", Page 40</i> Items of tableware are blocking the dispenser lid. 2. Do not place tableware or fragrance dispensers in the tablet collecting tray. |
| | The lid of the detergent dispenser is blocked by the tab and will not open. | ▶ Position the tab in the detergent dispenser crosswise, not vertically. |
| | Tabs are used in the quick or short programme. Dissolving time of the tab is not attained. | ▶ Select a more intensive Programme or use "Powder detergent" → <i>Page 36</i> . |

| Fault | Cause | Troubleshooting |
|---|--|--|
| Detergent residue in the appliance | Washing effect and dissolving performance are reduced after a prolonged storage time or detergent is very lumpy. | ▶ Change your "detergent" → <i>Page 36</i> . |
| Water marks on plastic parts. | Due to laws of physics droplet formation on plastic surfaces is unavoidable. After drying water marks are visible. | <ul style="list-style-type: none"> ▶ Select a more intensive programme. ▶ Position tableware at an angle. → <i>"Arrange tableware", Page 40</i> ▶ Use rinse aid. → <i>"Rinse aid", Page 35</i> ▶ Set the water softening system higher. → <i>"Setting water softening system", Page 33</i> |
| Wipeable or water-soluble coatings are present inside the appliance or on the door. | Detergent substances are deposited there. These coatings cannot generally be removed with chemicals. | <ul style="list-style-type: none"> ▶ Change your "detergent" → <i>Page 36</i>. ▶ Clean the appliance mechanically. |
| | White coating is deposited in the appliance interior. | <ol style="list-style-type: none"> 1. Set the water softening system correctly. → <i>"Setting water softening system", Page 33</i> In most cases you will need to increase the setting. 2. Change your detergent if required. |
| | Special salt dispenser is not screwed tight. | ▶ Screw the special salt dispenser tight. |
| Stubborn white coatings are present on tableware, inside the appliance or the door. | Detergent substances are deposited there. These coatings cannot generally be removed with chemicals. | <ul style="list-style-type: none"> ▶ Change your "detergent" → <i>Page 36</i>. ▶ Clean the appliance mechanically. |
| | The hardness range is set incorrectly or the water hardness is greater than 62 °E (8,9 mmol/l). | ▶ Set the "Water softening system" → <i>Page 32</i> to the water hardness or add special salt. |
| | 3in1/organic/eco detergent is not effective enough. | ▶ Set the "Water softening system" → <i>Page 32</i> to the water hardness and use separate detergents (proprietary detergent, special salt, rinse aid). |

| Fault | Cause | Troubleshooting |
|--|--|--|
| Stubborn white coatings are present on tableware, inside the appliance or the door. | Too little detergent is being used. | <ul style="list-style-type: none"> ▶ Increase the amount of detergent used or change "Detergent " → <i>Page 36</i>. |
| | Washing programme selected too weak. | <ul style="list-style-type: none"> ▶ Select a more intensive washing programme. ▶ Adjust the sensitivity of the sensors. → <i>"Sensors", Page 13</i> |
| Tea residue or lipstick marks on tableware. | Washing temperature is too low. | <ul style="list-style-type: none"> ▶ Select a programme with a higher washing temperature. |
| | Too little detergent is being used or is unsuitable. | <ul style="list-style-type: none"> ▶ Use a suitable "Detergent " → <i>Page 36</i> and follow the manufacturer's instructions for the amount to be used. |
| | Tableware has been pre-cleaned too intensely. The sensors chose a weaker programme. Stubborn soiling cannot be entirely removed. | <ul style="list-style-type: none"> ▶ Only remove large remnants of food and do not prerinse tableware. ▶ Adjust the sensitivity of the sensors. → <i>"Sensors", Page 13</i> |
| Coloured coatings (blue, yellow, brown) that are difficult or impossible to remove are present inside the appliance or on stainless steel tableware. | The formation of films is due to substances contained in vegetables (cabbage, celery, potatoes, noodles, etc.) or tap water (manganese). | <ul style="list-style-type: none"> ▶ Clean the appliance. You can remove deposits with "Mechanical cleaning" → <i>Page 50</i> or a machine cleaning product. It may not always be possible to completely remove deposits but they are harmless to health. |
| | The formation of films is due to metal components on silver or aluminium tableware. | <ul style="list-style-type: none"> ▶ Clean the appliance. You can remove deposits with "Mechanical cleaning" → <i>Page 50</i> or a machine cleaning product. It may not always be possible to completely remove deposits but they are harmless to health. |

| Fault | Cause | Troubleshooting |
|--|--|---|
| Coloured deposits (yellow, orange, brown) that are easy to remove are present inside the appliance (mainly at the bottom). | The formation of films is due to ingredients of food remnants and tap water (limescale) "soaplike". | <ol style="list-style-type: none"> 1. Check the setting of the water softening system. → <i>"Setting water softening system", Page 33</i> 2. Add special salt. → <i>"Adding special salt", Page 33</i> 3. If you are using combined detergents (tabs), activate the water softening system. Follow the information about detergents. → <i>"Information on detergents", Page 37</i> |
| Plastic parts inside the appliance are discoloured. | Plastic parts inside the appliance may become discoloured during the life of the dishwasher. | ▶ Discolouration can come about and will not impair functioning of the appliance. |
| Plastic parts are discoloured. | Washing temperature is too low. | ▶ Select a programme with a higher washing temperature. |
| | Tableware has been pre-cleaned too intensely. The sensors chose a weaker programme. Stubborn soiling cannot be entirely removed. | <ol style="list-style-type: none"> ▶ Only remove large remnants of food and do not prerinse tableware. ▶ Adjust the sensitivity of the sensors. → <i>"Sensors", Page 13</i> |
| Removable streaks are present on glasses, glassware with a metallic appearance and cutlery. | Amount of rinse aid to be dispensed is set too high. | <ol style="list-style-type: none"> ▶ Set the rinse aid system to a lower setting. → <i>"Setting the amount of rinse aid", Page 36</i> |
| | No rinse aid has been added. | ▶ → <i>"Adding rinse aid", Page 35</i> |
| | Detergent residue is present in the final rinse. Lid of the detergent dispenser is blocked by tableware items and will not open fully. | <ol style="list-style-type: none"> 1. Arrange tableware in the top basket tableware so the tab collecting tray is not obstructed by tableware. → <i>"Arrange tableware", Page 40</i> Items of tableware are blocking the dispenser lid. 2. Do not place tableware or fragrance dispensers in the tablet collecting tray. |

| Fault | Cause | Troubleshooting |
|---|--|--|
| Removable streaks are present on glasses, glassware with a metallic appearance and cutlery. | Tableware has been pre-cleaned too intensely. The sensors chose a weaker programme. Stubborn soiling cannot be entirely removed. | <ul style="list-style-type: none"> ▶ Only remove large remnants of food and do not prerinse tableware. ▶ Adjust the sensitivity of the sensors. → <i>"Sensors", Page 13</i> |
| Irreversible clouding of glassware. | Glasses are not dishwasher-proof, only suitable for dishwashers. | <ul style="list-style-type: none"> ▶ Use dishwasher-proof glasses. ▶ Avoid a lengthy steam phase (standing time after wash cycle ends). ▶ Use a programme with a lower temperature. ▶ Set the softening system to the water hardness. → <i>"Setting water softening system", Page 33</i> ▶ Use detergent with a glass protection component. |
| Rust spots on cutlery. | Cutlery is not sufficiently rust-resistant. Knife blades are often more severely affected. | ▶ Use rust-resistant tableware. |
| | Cutlery may also rust if washed together with rusting items. | ▶ Do not wash rusting items. |
| | Salt content in washing water is too high. | <ol style="list-style-type: none"> 1. Remove any spilled special salt from the tub. 2. Screw the cap of the special salt dispenser on tight. |
| Detergent residue is present in the detergent dispenser or the tablet collecting tray. | Spray arms were blocked by tableware so detergent was not rinsed out. | ▶ Check that the spray arms are not blocked and can rotate freely. |
| | Detergent dispenser was damp when detergent was added. | ▶ Only add detergent to a detergent dispenser when dry. |
| Excessive formation of foam occurs. | Hand washing-up liquid is present in dispenser for rinse aid. | ▶ Immediately add rinse aid to the dispenser. → <i>"Adding rinse aid", Page 35</i> |
| | Rinse aid has been spilled. | ▶ Remove the rinse aid with a cloth. |
| | Detergent or appliance care product used causes excessive foaming. | ▶ Change the brand of detergent. |

Home Connect problem

| Fault | Cause | Troubleshooting |
|---|---|---|
| Connection to home network is not established. | WLAN on router is not active. | ▶ Check the wireless network connection of your router. |
| WLAN display is flashing. | Connection to home network is not available. | ▶ Activate the wireless network connection on your router. |
| Home Connect cannot be implemented correctly. | Home Connect set incorrectly. | ▶ Please consult the documents supplied for Home Connect. |
| | Technical fault is present. | ▶ Please consult the information about support in the documents supplied for Home Connect. |
| Energy manager does not connect to the energy manager of the home system. | Connection to the energy manager of the home system is not available. | ▶ Please consult the instruction manual of the energy manager manufacturer of your home system. |

Information on display panel

| Fault | Cause | Troubleshooting |
|--|--|---|
| Special salt refill indicator lights up. | Insufficient special salt. | ▶ Add "Special salt" → <i>Page 33</i> . |
| | Sensor does not detect special salt tablets. | ▶ Do not use special salt tablets. |
| Refill indicator for special salt does not light up. | Water softening system is switched off. | ▶ "Setting water softening system" → <i>Page 33</i> |
| Refill indicator for rinse aid lights up. | Insufficient rinse aid. | <ol style="list-style-type: none"> 1. Add "Rinse aid" → <i>Page 35</i>. 2. Set the amount of rinse aid to be dispensed. → "<i>Setting the amount of rinse aid</i>", <i>Page 36</i> |
| Refill indicator for rinse aid does not light up. | Rinse aid system is switched off. | ▶ → " <i>Setting the amount of rinse aid</i> ", <i>Page 36</i> |
| Machine Care indicator lights up. | Machine care is recommended. | <p>▶ Run the Machine Care programme without tableware.</p> <ul style="list-style-type: none"> – Use a special machine care product. <p>The indicator will go out automatically after 3 wash cycles whether Machine Care is carried out or not.</p> |

Malfunctions

| Fault | Cause | Troubleshooting |
|---|---|---|
| Water is left in the appliance at the end of the programme. | Filter system or area under the filters is blocked. | <ol style="list-style-type: none"> 1. Clean the "Filters" → <i>Page 51</i>. 2. Clean the "Wastewater pump" → <i>Page 67</i>. |
| | Programme has not yet ended. | <ul style="list-style-type: none"> ▶ Wait until the programme ends or cancel the programme with reset. ▶ → <i>"Terminate programme"</i>, <i>Page 42</i> |
| Appliance cannot be switched on or operated. | Appliance functions have failed. | <ol style="list-style-type: none"> 1. Pull out the mains plug or switch off the fuse. 2. Wait at least 2 minutes. 3. Connect the appliance to the power supply. 4. Switch the appliance on. |
| Appliance does not start. | The mains fuse has tripped. | ▶ Check the relevant fuse. |
| | Mains cable is not inserted. | <ol style="list-style-type: none"> 1. Check whether the socket works. 2. Check whether the mains cable is properly inserted in the socket and on the rear of the appliance. |
| | Appliance door is not closed properly. | ▶ Close the appliance door. |
| Programme starts automatically. | You did not wait until programme ended. | ▶ → <i>"Terminate programme"</i> , <i>Page 42</i> |
| Appliance stops during the programme or cuts out. | Appliance door is not closed properly. | ▶ Close the appliance door. |
| | Power and/or water supply has been interrupted. | <ol style="list-style-type: none"> 1. Check the power supply. 2. Check the water supply. |
| | Top basket is pressing against inner door and preventing appliance door from being closed securely. | <ul style="list-style-type: none"> ▶ Check whether the rear panel of the appliance is being pressed in by a socket or hose holder that has not been removed. ▶ Arrange the tableware so that no parts project beyond the basket and prevent the appliance door from closing properly. |

Mechanical damage

| Fault | Cause | Troubleshooting |
|--|---|---|
| Appliance door cannot be closed. | Door lock has been activated. | ▶ Close the appliance door with greater force. |
| | Door cannot be closed due to installation method. | ▶ Check whether the appliance has been installed properly. When closed, the appliance door, its decor or attached parts should not knock against adjacent cabinets or the worktop. |
| | Automatic door opening is not in home position. | ▶ Wait for a second after opening the appliance door. |
| Lid on the detergent dispenser cannot be closed. | Detergent dispenser or lid are blocked by sticky detergent residue. | ▶ Remove detergent residue. |

Noise

| Fault | Cause | Troubleshooting |
|--|--|---|
| Filling valves making knocking noises. | Caused by the domestic installation. No appliance fault present. Does not affect functioning of the appliance. | ▶ Can only be remedied in the domestic installation. |
| Knocking or rattling noise. | Spray arm is striking tableware. | ▶ Arrange tableware so that the spray arms do not strike tableware. |
| | With a small load the water jets directly strike against the tub. | ▶ Distribute the tableware evenly. ▶ Load the appliance with more tableware. |
| | Light items of tableware move about during the wash cycle. | ▶ Position light items of tableware securely. |

Clean wastewater pump

Large remnants of food or foreign bodies can block the wastewater pump. As soon as the washing water no longer drains properly, the wastewater pump must be cleaned.

⚠ WARNING Risk of injury!

Sharp and pointed objects or fragments of glass may block the waste water pump and cause injury.

- ▶ Remove any foreign bodies carefully.
1. Disconnect the appliance from the power supply.
 2. Remove the top and bottom basket.
 3. Remove the filter system.
 4. Scoop out any water.
Use a sponge if necessary.
 5. Prise off the pump cover using a spoon and grip it by the crosspiece.

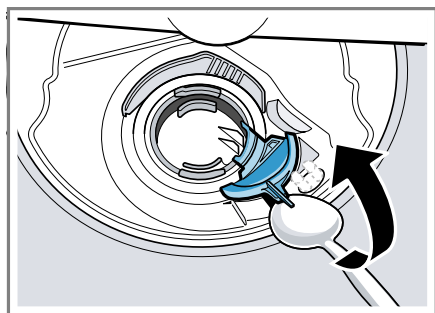

6. Lift the pump cover inwards at an angle and remove.
7. Remove any remnants of food and foreign bodies in the area of the impeller.

8. Insert the pump cover ① and press down ②.

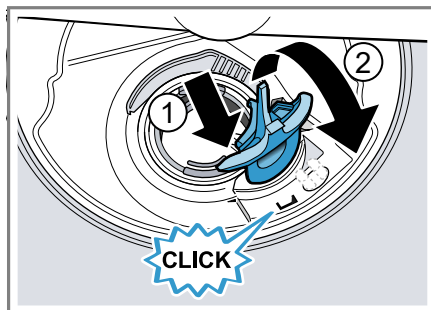

- ✓ The pump cover clicks into position.
9. Install the filter system.
 10. Insert the top and bottom basket.

Transportation, storage and disposal

You can find out here how to prepare your appliance for transportation and storage. You will also find out how to dispose of old appliances.

Removing the appliance

1. Disconnect the appliance from the power supply.
2. Turn off the water tap.
3. Detach the drainage connection.
4. Detach the drinking water connection.
5. Loosen any screws fastening the appliance to cabinet parts.
6. Remove the base panel if fitted.
7. Pull the appliance out carefully, along with the hose behind it.

Protect appliance from frost

If there is a risk of frost where the appliance will be standing, e.g. in a holiday home, empty the appliance completely.

- ▶ "Empty the appliance."
→ Page 68

Transporting the appliance

To avoid damage to the appliance, empty it before transporting.

Note: Always transport the dishwasher upright to prevent residual water getting into the machine's controls and damaging the appliance.

1. Remove tableware from the appliance.
2. Secure loose parts.
3. "Switch on appliance." → Page 41
4. Select the programme with the highest temperature.
→ "Programmes", Page 20
5. "Start the programme." → Page 42
6. To drain the appliance, terminate the programme after approx. 4 minutes.
→ "Terminate programme", Page 42
7. "Switch off the appliance."
→ Page 42
8. Turn off the water tap.
9. To empty the residual water out of the appliance, detach the supply hose and let the water drain out.

Disposing of old appliance

Valuable raw materials can be reclaimed by recycling.

WARNING

Risk of harm to health!

Children can lock themselves in the appliance, thereby putting their lives at risk.

- ▶ With redundant appliances, unplug the power cord. Then cut through the cord and damage the lock on the appliance door beyond repair so that the appliance door will no longer close.

1. Unplug the appliance from the mains.
2. Cut through the power cord.
3. Dispose of the appliance in an environmentally friendly manner.



This appliance is labelled in accordance with European Directive 2012/19/EU concerning used electrical and electronic appliances (waste electrical and electronic equipment - WEEE). The guideline determines the framework for the return and recycling of used appliances as applicable throughout the EU.

Customer Service

If you have any queries, are unable to rectify faults on the appliance yourself or if your appliance needs to be repaired, contact Customer Service. You can solve many problems yourself by consulting the information on troubleshooting in these instructions or on our website. If this is not the case, contact our after-sales service.

With any warranty claims, we will make sure that your appliance is repaired by trained after-sales technicians using genuine spare parts, including after the manufacturer's warranty has expired.

Function-relevant genuine spare parts according to the corresponding Eco-design Order can be obtained from Customer Service for a period of at least 10 years from the date on which your appliance was placed on the market within the European Economic Area.

Note: Under the terms of the manufacturer's warranty the use of Customer Service is free of charge.

Detailed information on the warranty period and terms of warranty in your country is available from our after-sales service, your retailer or on our website.

If you contact Customer Service, you will require the product number (E-Nr.) and the production number (FD) of your appliance.

The contact details for Customer Service can be found in the enclosed Customer Service directory or on our website.

Product number (E-Nr.) and production number (FD)

You can find the product number (E-Nr.) and the production number (FD) on the appliance's rating plate.

The rating plate is located inside the appliance door.

Make a note of your appliance's details and the Customer Service telephone number to find them again quickly.

AQUA-STOP guarantee¹

In addition to warranty claims against the seller under the purchase agreement and in addition to our manufacturer's warranty, we will provide a replacement under the following conditions.

- If our Aqua-Stop system is defective and causes water damage, we will make good the damage for private users. To ensure protection from water damage, the appliance must be connected to the power supply.
- The liability guarantee is valid for the service life of the appliance.
- A claim can only be made under the guarantee if the appliance has been correctly installed and connected with Aqua-Stop according to our instructions; this also includes correctly fitting the Aqua-Stop extension (genuine accessory). Our guarantee does not cover defective supply lines or fittings up to the Aqua-Stop connection on the tap.
- If your appliance is fitted with Aqua-Stop, you can leave your appliance unattended during operation and the tap turned on afterwards. The tap only needs to be turned off if you are away from home for a long period, e.g. on holiday for several weeks.

Technical specifications

Facts and figures for your appliance can be found here.

| | |
|---------|-----------------------------|
| Weight | Max.: 60 kg |
| Voltage | 220 - 240 V, 50 Hz or 60 Hz |

¹ Depending on the appliance specifications

en Technical specifications

| | |
|-------------------|---|
| Power rating | 2000 - 2400 W |
| Fuse | 10 - 16 A |
| Power consumption | Off mode/standby mode: 0.50 W Left-on mode: 0.50 W Networked standby: 2.00 W Time in left-on mode: 0 min Time after which appliance is switched to networked standby mode: 15 min Complies with the latest regulations (EU) for energy labels and ecodesign at the time of placing on the market. Additional functions and settings may increase power consumption and times. |
| Water pressure | ■ Min. 0.05 MPa (0.5 bar) ■ Max. 1 MPa (10 bar) |
| Inlet rate | Min. 10 l/min |
| Water temperature | Cold water. Hot water max.: 60 °C |
| Capacity | 12 - 15 place settings |

This product contains light sources from energy efficiency class G. These light sources are available as a spare part and should only be replaced by trained specialist staff.¹

More information about your model can be found online at <https://energylabel.bsh-group.com>². This web address is linked to the official EU EPREL product database. At the time of printing its web address had not

yet been published. Please then follow the instructions on searching for models. The model identifier is made up of the characters before the slash in the product number (E-Nr.) on the rating plate. Alternatively you can also find the model identifier in the first line of the EU energy label.

¹ Depending on the appliance specifications

² Only applies to countries in the European Economic Area

Gaggenau Hausgeräte GmbH
Carl-Wery-Straße 34
81739 München
GERMANY
www.gaggenau.com

GAGGENAU



9001509372 en 001015