

Gaggenau

en Information for Use

CV49210.

FlexInduction hob with integrated ventilation system

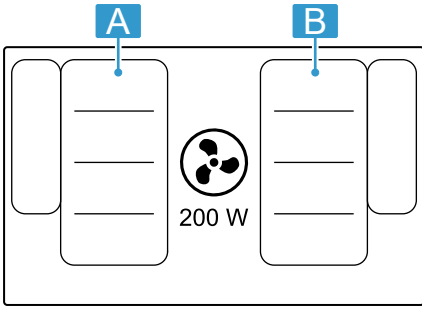

| A/B | I_2^1 | P^1 |
|---------|---------|--------|
| III III | 2200 W | 3700 W |
| III | 3300 W | 3700 W |
| III II | 2600 W | 3700 W |
| III II | 3300 W | 3700 W |

¹ IEC 60335-2-6

Table of contents

| | | |
|----|--|----|
| 1 | Safety | 3 |
| 2 | Preventing material damage | 5 |
| 3 | Environmental protection and saving energy | 6 |
| 4 | Disposal..... | 6 |
| 5 | Induction cooking | 7 |
| 6 | Familiarising yourself with your appliance | 9 |
| 7 | Operating modes | 11 |
| 8 | Before using for the first time | 11 |
| 9 | Basic operation | 12 |
| 10 | Flex Zone | 14 |
| 11 | FlexPlus Zone..... | 15 |
| 12 | Timer function | 16 |
| 13 | Booster function | 17 |
| 14 | Frying sensor function | 18 |
| 15 | Automatic switch-off..... | 20 |
| 16 | Locking the control panel for cleaning..... | 20 |
| 17 | Basic settings..... | 20 |
| 18 | Home Connect | 22 |
| 19 | Cookware test | 24 |
| 20 | Cleaning and servicing..... | 25 |
| 21 | FAQs | 28 |
| 22 | Troubleshooting..... | 30 |
| 23 | Customer Service..... | 33 |
| 24 | Declaration of Conformity | 33 |



1 Safety

Observe the following safety instructions.

1.1 General information

- Read this instruction manual carefully.
- Keep the instructions, the appliance and the product information safe for future reference or for the next owner.
- Do not connect the appliance if it has been damaged in transit.

1.2 Intended use

Only a licensed professional may connect appliances without plugs. Damage caused by incorrect connection is not covered under the warranty.

The appliance can only be used safely if it is correctly installed according to the safety instructions. The installer is responsible for ensuring that the appliance works perfectly at its installation location.

Only use this appliance:

- To prepare meals and drinks.
- Under supervision. Never leave the appliance unattended when cooking for short periods.
- in private households and in enclosed spaces in a domestic environment.
- up to an altitude of max. 4000 m above sea level.

Do not use the appliance:

- On boats or in vehicles.
- With an external timer or a separate remote control. This does not apply if operation with appliances included in EN 50615 is switched off.
- To extract hazardous or explosive substances and vapours.
- To extract small parts and liquids.

If you wear an active implantable medical device (e.g. a pacemaker or defibrillator), check with your doctor that it complies with Council Directive 90/385/EEC of 20th June 1990, EN 45502-2-1 and EN 45502-2-2, and that it has been chosen, implanted and programmed in accordance with VDE-AR-E 2750-10. If these conditions are satisfied, and if, in addition, non-metal cooking utensils and cookware with non-metal handles are used, it is safe to use this induction hob as intended.

1.3 Restriction on user group

This appliance may be used by children aged 8 or over and by people who have reduced physical, sensory or mental abilities or inadequate experience and/or knowledge, provided that they are supervised or have been instructed on how to use the appliance safely and have understood the resulting dangers.

Do not let children play with the appliance.

Children must not perform cleaning or user maintenance unless they are at least 15 years old and are being supervised.

Keep children under the age of 8 years away from the appliance and power cable.

1.4 Safe use

⚠ WARNING – Risk of suffocation!

Children may breathe in or swallow small parts, causing them to suffocate.

- ▶ Keep small parts away from children.
 - ▶ Do not let children play with small parts.
- Children may put packaging material over their heads or wrap themselves up in it and suffocate.
- ▶ Keep packaging material away from children.
 - ▶ Do not let children play with packaging material.

⚠ WARNING – Risk of poisoning!

Risk of poisoning from flue gases being drawn back in. Room-air-dependent heat-producing appliances (e.g. gas, oil, wood or coal-operated heaters, continuous flow heaters or water heaters) obtain combustion air from the room in which they are installed and discharge the exhaust gases into the open through an exhaust gas system (e.g. a chimney). With the extractor hood switched on, air is extracted from the kitchen and the adjacent rooms. Without an adequate supply of air, the air pressure falls below atmospheric pressure. Toxic gases from the chimney or the extraction shaft are sucked back into the living space.

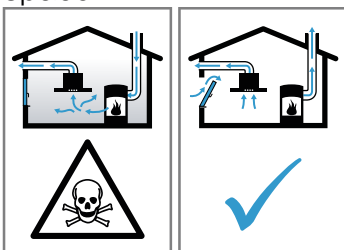

- ▶ Always ensure adequate fresh air in the room if the appliance is being operated in exhaust air mode at the same time as a room-air-dependent heat-producing appliance is being operated.
- ▶ It is only possible to safely operate the appliance if the pressure in the room in which the heating appliance is installed does not fall below 4 Pa (0.04 mbar). This can be achieved whenever the air needed for com-

bustion is able to enter through openings that cannot be sealed, for example in doors, windows, incoming/exhaust air wall boxes or by other technical means. An incoming/exhaust air wall box alone is not sufficient to ensure compliance with the limit.

- ▶ In any case, consult your responsible chimney sweep. They are able to assess the house's entire ventilation setup and will suggest the suitable ventilation measures to you.
- ▶ Unrestricted operation is possible if the appliance is operated exclusively in circulating-air mode.

⚠ WARNING – Risk of fire!

Leaving fat or oil cooking on an unattended hob can be dangerous and may lead to fires.

- ▶ Never leave hot oil or fat unattended.
- ▶ Never attempt to extinguish a fire using water; instead, switch off the appliance and then cover with a lid or a fire blanket.

The cooking surface becomes very hot.

- ▶ Never place flammable objects on the cooking surface or in its immediate vicinity.
- ▶ Never place objects on the cooking surface.

The appliance will become hot.

- ▶ Do not keep combustible objects or aerosol cans in drawers directly underneath the hob.

Hob covers can cause accidents, for example due to overheating, catching fire or materials shattering.

- ▶ Do not use hob covers.

After every use, switch off the hob using the controls.

- ▶ Do not wait until the hob turns off automatically as there are no longer any pots and pans on it.

Fatty deposits in the grease filters may catch fire.

- ▶ Never operate the appliance without a grease filter.
- ▶ Clean the grease filters regularly.
- ▶ Never work with naked flames close to the appliance (e.g. flambéing).
- ▶ Do not install the appliance near a solid fuel heating appliance (e.g. wood- or coal-burning) unless the heating appliance has a sealed, non-removable cover. There must be no flying sparks.

⚠ WARNING – Risk of burns!

The appliance and its parts that can be touched become hot during use, particularly the hob surround, if fitted.

- ▶ Caution should be exercised here in order to avoid touching heating elements.
- ▶ Young children under 8 years of age must be kept away from the appliance.

Hob protective grilles may cause accidents.

- ▶ Never use hob protective grilles.

Metal objects on the hob quickly become very hot.

- ▶ Never place metal objects (such as knives, forks, spoons and lids) on the hob.

The ventilation grille will quickly become extremely hot if it is placed on the hob.

- ▶ Never place the ventilation grille on the hob.
- ▶ Do not place any pans on the ventilation grille.
- ▶ Do not place any hot objects on the ventilation grille.

The appliance becomes hot during operation.

- ▶ Allow the appliance to cool down before cleaning.
- ▶ If hot liquids penetrate the appliance, only remove the ventilation grille, grease filter or the overflow container once the appliance has cooled down.

⚠ WARNING – Risk of electric shock!

Improper repairs are dangerous.

- ▶ Repairs to the appliance should only be carried out by trained specialist staff.
- ▶ Only use genuine spare parts when repairing the appliance.
- ▶ If the power cord or the appliance power cable of this appliance is damaged, it must be replaced with a special power cord or special appliance power cable, which is available from the manufacturer or its Customer Service.

If the appliance or the power cord is damaged, this is dangerous.

- ▶ Never operate a damaged appliance.
- ▶ Never operate an appliance with a cracked or fractured surface.
- ▶ Call customer services. → *Page 33*

An ingress of moisture can cause an electric shock.

- ▶ Do not use steam- or high-pressure cleaners to clean the appliance.

The insulation on cables of electrical appliances may melt if it touches hot parts of the appliance.

- ▶ Never bring electrical appliance cables into contact with hot parts of the appliance.

⚠ WARNING – Risk of injury!

Saucepans may suddenly jump due to liquid between the saucepan base and the hotplate.

- ▶ Always keep hotplates and saucepan bases dry.
- ▶ Never use icy-cold cookware that has been in the freezer.

When cooking in a bain marie, the hob and cooking container could shatter due to overheating.

- ▶ The cooking container in the bain marie must not directly touch the bottom of the water-filled pot.
- ▶ Only use heat-resistant cookware.

An appliance with a cracked or broken surface can cause cuts.

- ▶ Do not use the appliance if it has a cracked or broken surface.

2 Preventing material damage

ATTENTION!

Rough pot and pan bases will scratch the ceramic.

- ▶ Check your cookware.

Boiling pans dry may damage cookware or the appliance.

- ▶ Never place empty pans on a heated hotplate or allow to boil dry.

Incorrectly positioned cookware can cause the electronics to overheat.

- ▶ Never place hot pots or pans on the controls, the displays, the hob surround or the ventilation grille. Damage can occur if hard or pointed objects fall onto the hob.

- ▶ Do not let hard or pointed objects fall onto the hob.

Non heat-resistant materials will melt on heated hot-plates.

- ▶ Do not use oven protective foil.
- ▶ Do not use aluminium foil or plastic containers.

2.1 Overview of the most common damage

Here you can find the most common types of damage and tips on how to avoid them.

| Damage | Cause | Measure |
|--------|------------------------------|---|
| Stains | Food boiling over | Remove boiled-over food immediately with a glass scraper. |
| Stains | Unsuitable cleaning products | Only use cleaning products that are suitable for glass ceramic. |

| Damage | Cause | Measure |
|----------------|---|---|
| Scratches | Salt, sugar or sand | Do not use the hob as a work surface or storage space. |
| Scratches | Rough pot or pan bases | Check your cookware. |
| Discolouration | Unsuitable cleaning products | Only use cleaning products that are suitable for glass ceramic. |
| Discolouration | Pan abrasion, e.g. aluminium | Lift pots and pans to move on the hob. |
| Blisters | Sugar or food with a high sugar content | Remove boiled-over food immediately with a glass scraper. |

3 Environmental protection and saving energy

3.1 Disposing of packaging

The packaging materials are environmentally compatible and can be recycled.

- ▶ Sort the individual components by type and dispose of them separately.

3.2 Saving energy

If you follow these instructions, your appliance will use less energy.

Select the cooking zone to match the size of your pan. Centre the cookware on the hob. Use cookware whose base diameter is the same diameter as the hotplate.

Tip: Cookware manufacturers often give the upper diameter of the saucepan. It is often larger than the base diameter.

- Unsuitable cookware or incompletely covered cooking zones consume a lot of energy.

Cover saucepans with suitable lids.

- Cooking without a lid consumes considerably more energy.

Lift lids as infrequently as possible.

- When you lift the lid, a lot of energy escapes.

Use a glass lid.

- You can see into the pan through a glass lid without having to lift it.

Use pots and pans with flat bases.

- Uneven bases increase energy consumption.

Use cookware that is suitable for the quantity of food.

- Large items of cookware containing little food need more energy to heat up.

Cook with only a little water.

- The more water that is contained in the cookware, the more energy is required to heat it up.

Turn down to a lower power level early on. Use a suitable ongoing power level.

- If you use an ongoing power level that is too high, you will waste energy.

Adjust the fan speed to the amount of steam produced during cooking.

- The lower the fan speed, the less energy is consumed.

Only use the intensive mode as required.

If cooking produces large amounts of steam, select a higher fan speed in good time.

- The odours are distributed around the room less.

Switch the appliance off when you are not using it.

-

Ensure that there is sufficient ventilation when cooking.

- The appliance works more efficiently and with fewer operating noises.

Clean or replace the filters at regular intervals.

- The effectiveness of the filter is retained.

Product Information according (EU) 66/2014 can be found on the attached appliance pass and online on the product page for your appliance.

4 Disposal

4.1 Disposing of old appliance

Valuable raw materials can be reused by recycling.

- ▶ Dispose of the appliance in an environmentally friendly manner.

Information about current disposal methods are available from your specialist dealer or local authority.



This appliance is labelled in accordance with European Directive 2012/19/EU concerning used electrical and electronic appliances (waste electrical and electronic equipment - WEEE).

The guideline determines the framework for the return and recycling of used appliances as applicable throughout the EU.

5 Induction cooking

5.1 Advantages of induction cooking

Induction cooking is fundamentally different from traditional cooking methods, since the heat builds up directly in the cookware. This offers numerous advantages:

- Saves time when boiling and frying.
- Saves energy.
- Easier to care for and clean. Spilled food does not burn on as quickly.
- Controlling the heat supply and safety; the hob increases or decreases the heat supply as soon as the user changes the setting. The induction cooking zone stops the heat supply if you remove the cookware from the cooking zone without you having to switch it off first.

5.2 Cookware

Only ferromagnetic cookware is suitable for induction cooking.

For example:

- Enamelled steel cookware
- Cast iron cookware
- Special induction-compatible cookware made from stainless steel

Use Cookware test to check whether the cookware is suitable. Refer to

→ "Cookware test", Page 24 for more details.

In order to achieve a good cooking result, ensure that the ferromagnetic area of the cookware base corresponds to the size of the cooking zone. If the cookware is not detected on a cooking zone, place it on a cooking zone with a smaller diameter.

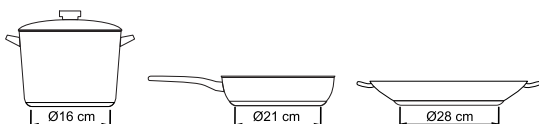

If you are using the Flex Zone as a single cooking zone, you can use larger cookware that is particularly suited to this zone. You can find information on positioning the cookware in → "Flex Zone", Page 14.



On some items of induction cookware, the base is not fully ferromagnetic: For large cookware with a smaller ferromagnetic base, only the area that is ferromagnetic heats up. As a result, the heat is not distributed evenly. The temperature of the non-ferromagnetic area may therefore be too low for cooking.

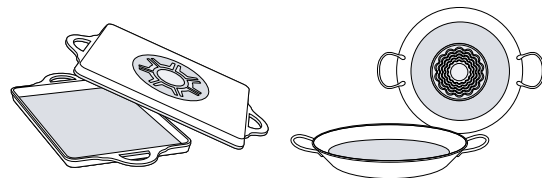

Cookware bases that contain aluminium reduce the ferromagnetic area. This may reduce the output and the cookware will not be detected sufficiently or at all, and will therefore not be heated sufficiently.

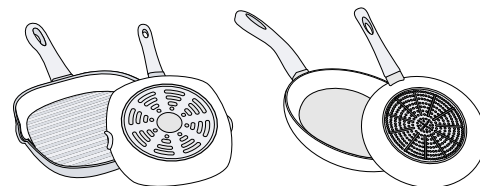

Unsuitable cookware

Never use flow plates or cookware made of the following:

- Thin-walled normal steel
- Glass
- Clay
- Copper
- Aluminium

Composition of the cookware base

The material(s) from which the base of the cookware is made may affect the cooking result. Cookware made of materials that distribute heat evenly in the pot, such as saucepans with a stainless steel sandwich base, save time and energy.

You should ideally use cookware with a flat base, as uneven cookware bases impair the heat supply.

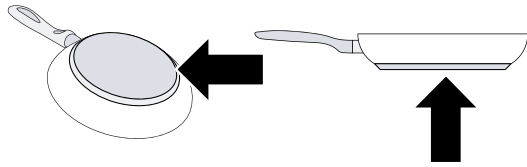

No cookware/cookware of an unsuitable size

If you do not place cookware on the selected cooking zone or the cookware is made of an unsuitable material or is not the right size for the cooking zone, the display for the cooking zone flashes. To switch off the display, place a suitable item of cookware on the cooking zone. If you do not place a suitable item of cookware on the cooking zone within nine minutes, it automatically switches off.

Empty cookware or cookware with a thin base

Do not heat empty items of cookware and do not use cookware with a thin base. The hob is equipped with an internal safety system. Empty cookware may heat up so quickly that the "Automatic switch-off" function does not respond in good time. This results in an excessive temperature that melts the base of the cookware and damages the glass plate. In this case, do not touch the cookware, and switch off the cooking zone. If the cooking zone no longer works after cooling down, contact the technical customer service.

Cookware detection

Each cooking zone has a minimum limit for the cookware detection and this depends on the ferromagnetic diameter and the material of the base of the cookware. Therefore, always use the cooking zone that best corresponds to the diameter of the pot base.

6 Familiarising yourself with your appliance

6.1 Your new appliance

You can find an overview of the parts of your appliance here.

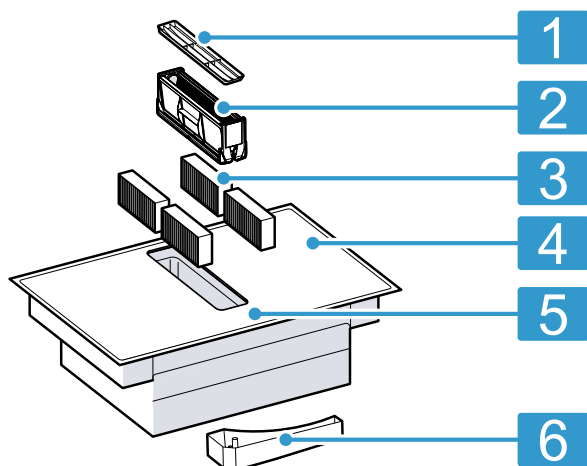

| No. | Designation |
|-----|---|
| 1 | Ventilation grille |
| 2 | Grease filter |
| 3 | Odour filter for circulating-air mode or acoustics filter for air extraction mode |
| 4 | Hob |

| No. | Designation |
|-----|--------------------|
| 5 | Control panel |
| 6 | Overflow container |

6.2 Optional accessories

Depending on the appliance model, various accessories are available and you can obtain these from specialist retailers, from our customer service or from our official website.

| | |
|--|-----------|
| Odour filter | CA282112 |
| Acoustic filter | CA084010 |
| Unducted air recirculation kit | CA08201. |
| Ducted air recirculation kit, 60 cm work surface | CA08206. |
| Ducted air recirculation kit, 70 cm work surface | CA08207. |
| 4 control knobs, black | CKI440000 |
| 4 control knobs, stainless steel | CKI440010 |
| Teppan Yaki made from multi-layered material | CA051300 |
| Cast aluminium griddle plate | CA052300 |

6.3 Control panel

You can use the control panel to configure some functions of your appliance and to obtain information about the operating status.

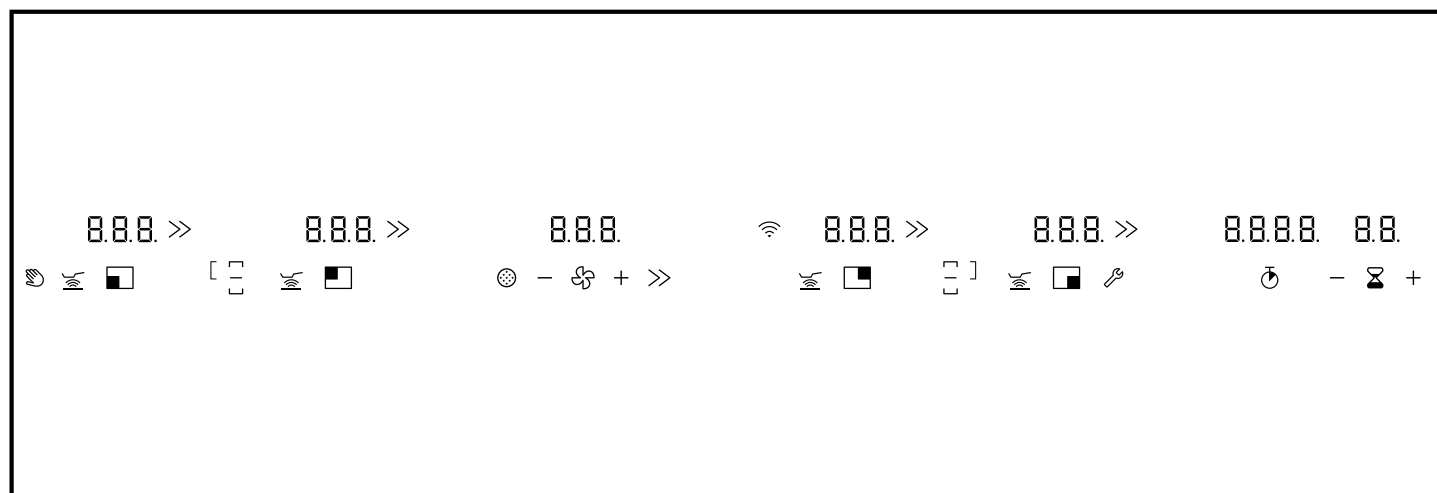

Touch fields



Touch fields are touch-sensitive surfaces. To select a function, touch the relevant field.

| | |
|--|---|
| | Locking the control panel for cleaning |
| | Switching on the frying sensor function |

¹ The symbol can light up orange or white.





















| | |
|--|---|
| | Activating intensive mode for the ventilation system ¹ |
| | Opening the basic settings |
| | Selecting the fan settings/setting the timer function |
| | Resetting the saturation indicator ¹ |

¹ The symbol can light up orange or white.

| | |
|--|----------------------------|
|  | Switching on the stopwatch |
|  | Setting the kitchen timer |
| ¹ The symbol can light up orange or white. | |

Indicators on the display

The displays show set values and functions.

| | |
|--|--|
|  | Operating status |
|  | Cooking zone |
|  | Power levels |
|  | Fan settings |
|  | Frying sensor function |
|  | PowerBoost function for cooking zones/intensive mode for ventilation |
|  | Residual heat |
|  | Kitchen timer |
|  | Stopwatch function |
|  | Control panel lock for cleaning |
|  | Flex function activated |
|  | Flex function deactivated |
|  | FlexPlus function activated |
|  | Ventilation system is switched on ¹ |
|  | Intensive mode for the ventilation system ¹ |
|  | Intermittent function for the ventilation system |
|  | Ventilation system automatic mode |
|  | Frying sensor temperature indicator |
|  | Fan run-on |
|  | Odour filter saturation indicator ¹ |
|  | Home network |
| ¹ The symbol can light up orange or white. | |

Touch fields and displays

When the hob is switched on, the symbols for the currently available touch fields light up. The displays for the selected cooking zones or functions light up orange.

Touch a symbol to activate the corresponding function. An audible confirmation signal sounds.





- Always keep the control panel clean and dry. Moisture reduces its effectiveness.
- Do not place any cookware near the indicators or touch fields. The electronics may overheat.

Control knobs

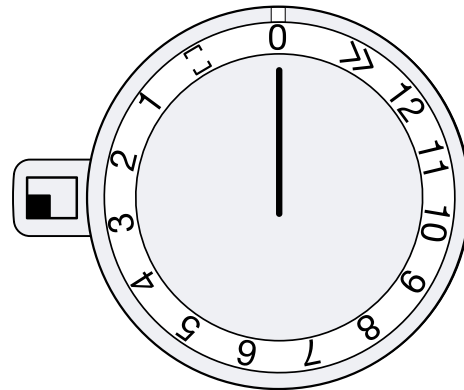
You can use the control knobs to set some functions of your appliance and to obtain information about the operating status.

The markings on the control knob show the assignment to each cooking zone and the setting from power level 1 to 12 or the PowerBoost function and the flex function.



| | |
|---|--------------------------------------|
| 0-12 | Setting the power level |
| »» | Activating the PowerBoost function |
|  | Activating the flex function |
|  | Setting the front left cooking zone |
|  | Setting the rear left cooking zone |
|  | Setting the rear right cooking zone |
|  | Setting the front right cooking zone |

Indicators on the illuminated rings

Each control knob is encircled by an illuminated ring with various display functions. The illuminated ring on the control knob lights up orange during operation. You can choose between two colour shades. If you have several appliances installed next to each other, you can change the shades in the settings for the appliances so that all of the illuminated rings light up in the same shade.



→ "Changing the colour of the illuminated ring", Page 14

| Display | Name |
|---|--|
| Off | Appliance OFF |
| Lights up: Orange | Appliance ON |
| Flashing: Orange | Appliance OFF Residual heat indicator |
| Light up: Blue | Home Connect |
| Flash: Blue | Home Connect, appliance is connected to the home network |
| Flashing alternately: Orange and white | Safety switch-off function, power failure |
| Flashing alternately: Yellow and magenta | Appliance fault. Call customer service. |
| Lights up: Green for a few seconds, then turns yellow | The appliance is initialising during initial connection or following a power failure |

6.4 Cooking zones

You can find an overview of the different cooking zone activations here.

You can find more information on which items of cookware are suitable for induction cooking in "Induction cooking".
→ "Induction cooking", Page 7

| Symbol | Cooking zone type | Switching on |
|--|-----------------------|---|
|  | Single cooking zone | Use cookware of a suitable size. |
|  | Flexible cooking zone | You can find more information in "Flexible cooking zone". → Page 14 |
|  | FlexPlus cooking zone | The FlexPlus cooking zone always switches on in conjunction with one of the flexible cooking zones. You can find more information in "FlexPlus cooking zone". → Page 15 |

6.5 Residual heat indicator

The hob has a two-stage residual heat indicator for each cooking zone. This indicates that a cooking zone is still hot. Do not touch the cooking zone if the residual heat indicator is lit.

The following is displayed depending on the amount of residual heat:

- *H* display: High temperature
- *h* display: Low temperature

The illuminated ring on the control knob flashes.

If the FlexPlus cooking zone has been activated, the FlexPlus cooking zone display also lights up.

If you remove the cookware from the cooking zone during cooking, the power level indicator flashes and the illuminated ring on the control knob lights up orange.

If you switch off the cooking zone, the residual heat indicator lights up and the illuminated ring on the control knob flashes. Even if the hob has already been switched off, the residual heat indicator remains lit for as long as the cooking zone remains warm.

7 Operating modes

You can use your appliance in air extraction mode or circulating-air mode.

7.1 Air extraction mode

The air which is drawn in is cleaned by the grease filters and conveyed to the exterior by a pipe system.



The air must not be discharged into a flue that is used for exhausting fumes from appliances burning gas or other fuels (not applicable to appliances that only discharge the air back into the room).

- If the exhaust air is to be conveyed into a non-functioning smoke or exhaust gas flue, you must obtain the consent of the heating engineer responsible.
- If the exhaust air is conveyed through the external wall, a telescopic duct should be used.

7.2 Air recirculation

The air which is drawn in is cleaned by the grease filters and an odour filter, and conveyed back into the room.



To bind odours in air recirculation mode, you must install an odour filter. The different options for operating the appliance in air circulation mode can be found in our catalogue. Alternatively, ask your dealer. The required accessories are available from specialist retailers, from our after-sales service or from the online shop.

Note: When cooking intensively and for a long time, moisture is released into the air in the room. When using the appliance in air recirculation mode, we recommend ventilating the kitchen adequately, e.g. by briefly opening a window to remove excessive moisture.

8 Before using for the first time

Implement the settings for the initial configuration. Clean the appliance and accessories.

8.1 Setting up Home Connect

- ▶ Set up Home Connect.
→ "Home Connect", Page 22

8.2 Setting an operating mode

Requirement: When it is delivered, the appliance is set to air recirculation mode.

- ▶ To change the appliance to air extraction mode, see Basic settings → Page 20.

8.3 Colour shades of the illuminated rings

The illuminated ring on the control knob lights up orange during operation. You can choose between two colour shades.

You can change the colour shades so that all of the illuminated rings across several appliances light up in the same shade.

→ "Changing the colour of the illuminated ring", Page 14

9 Basic operation

9.1 Setting the hob

Notes

- If the appliance has not been connected to your home network or the connection has been broken, the network connection initial set-up will be activated whenever you switch on the hob.
 - Never operate the appliance without the filter and the overflow container.
 - If you place cookware on a flexible cooking zone, the hob detects the cookware and the cooking zone is automatically selected. You can find more information about this under → "Flex Zone", Page 14.
 - If there is no cookware on the cooking zone or if the appliance does not detect the cookware, the selected power level flashes and the illuminated ring on the control knob lights up orange. After approx. nine minutes, the appliance switches the cooking zone off. The illuminated ring on the control knob flashes. Turn the control knob to 0; the illuminated ring on the control knob goes out.
1. Use cookware with a suitable diameter.
 - Ensure that the base of the cookware sits within the marked cooking zones.
 2. Use the control knob to select the cooking zone.
 3. Push in the control knob and turn it to the required power level.

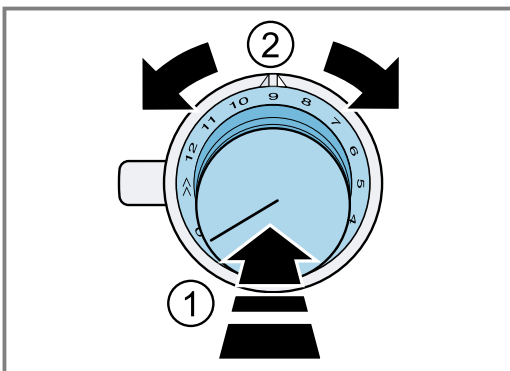

- ✓ The selected power level lights up on the display.

Recommended settings for cooking

This is where you can find an overview about which power levels are suitable for which food. The cooking time may vary depending on the type, weight, thickness and quality of the food.

| Power level | Cooking method | Examples |
|-------------|----------------------|------------------|
| 11-12 | Parboiling | Water |
| | Searing | Meat |
| | Heating | Fat/oil, liquids |
| | Bringing to the boil | Soups, sauces |

- ✓ The illuminated ring on the control knob lights up.

Notes

- In order to protect the appliance's electronic parts from overheating or surge currents, the hob may temporarily reduce the power level.
- In order to prevent the appliance from producing excess noise, the hob may temporarily reduce the power level.

9.2 Switching the hob off

- ▶ Turn all of the control knobs to 0.
- ✓ The residual heat indicator lights up and the illuminated ring on the control knob flashes until the cooking zone has cooled down.

9.3 Cooking instructions

This is where you can find an overview of useful cooking instructions for dishes or for using cookware.

- When heating up puree, cream soups or thick sauces, stir occasionally.
- To preheat, set power level 10–12.
- When cooking with the lid on, reduce the power level as soon as you see steam escaping. The cooking result is not affected by the steam escaping.
- After cooking, place a lid on the cookware until you serve the dish.
- To cook with the pressure cooker, observe the manufacturer's instructions.
- Do not cook food for too long, otherwise nutrients will be lost. The short-term timer enables you to set the optimum cooking time.
- Ensure that the oil does not smoke.
- To brown the food, fry it in small portions, one after the other.
- Some items of cookware may reach high temperatures while the food is cooking. You should therefore use oven gloves.
- You can find recommendations for energy-efficient cooking in → "Saving energy", Page 6.

| Power level | Cooking method | Examples |
|-------------|----------------------------|--|
| | Blanching | Vegetables |
| 7-10 | Frying | Meat, potatoes |
| 6-8 | Frying | Fish |
| 8-9 | Baking | Pastries, egg dishes, e.g. pancakes |
| | Simmering in open cookware | Pasta, liquids |
| 7-8 | Browning | Flour, onions |
| | Roasting | Almonds, breadcrumbs |
| | Rendering | Bacon |
| | Reducing | Stocks, sauces |
| 6-7 | Poaching in open cookware | Dumplings, soup ingredients, soup meat, poached eggs |
| 5-6 | Poaching in open cookware | Boiled sausages |
| 6-7 | Steaming | Vegetables, potatoes, fish |
| | Stewing | Vegetables, fruit, fish |
| | Braising | Roulade, roasts, vegetables |
| 3-4 | Braising | Goulash |
| 4-5 | Cooking with the lid on | Soups, sauces |
| 3-4 | Defrosting | Frozen products |
| | Soaking | Rice, pulses, vegetables |
| | Thickening | Egg dishes, e.g. omelette |
| 1-2 | Heating/keeping warm | Soups, vegetables in sauce |
| 1 | Heating/keeping warm | Stews |
| | Melting | Butter, chocolate |

9.4 Switching on the ventilation power level

Notes

- Optimal extraction power cannot be guaranteed for tall cookware. You can improve the extraction power using a lid placed at an angle.
- Do not block the ventilation openings with objects. Do not place any items on the ventilation grille. Otherwise, this reduces the ventilation performance.
- Always adjust the performance level to the current conditions. Set a high power level for strong cooking vapours.

Requirement: Automatic mode is switched on.

→ "Basic settings", Page 20

- ▶ Use a control knob to select a power level.
- ✓ The ventilation starts.

9.5 Changing the ventilation power level

- ▶ Use — or + to set the required power level.
- ✓ The set power level lights up.

9.6 Switching off the ventilation power level

- ▶ Use — to set the required power level .

9.7 Switching on intensive mode

If particularly strong odours or vapours develop, you can use intensive mode.

- ▶ Press >>.
- ✓ The intensive mode is switched on.
- ✓ >> lights up.

- ✓ After approx. six minutes, the appliance switches back to the power level .

9.8 Switching off intensive mode

- ▶ Press >>.
- ✓ The intensive mode is switched off.

9.9 Automatic mode with sensor control

In automatic mode, a sensor in the appliance detects the intensity of the cooking odours and roasting odours. The optimal fan speed is automatically switched on depending on the sensor sensitivity setting. If the sensor control reacts too weakly or too strongly, you can change the setting for the sensor sensitivity.

Switching on automatic mode with sensor control

- ▶ In the basic settings, define the setting for the automatic mode.
→ "Basic settings", Page 20
- ✓ The optimal power level is automatically set using a sensor.

Switching off automatic mode with sensor control

- ▶ Press — until another power level or  lights up.
- ✓ Automatic mode with sensor control is switched off.

9.10 Fan run-on

The fan run-on only starts if at least one cooking zone has been switched on for at least one minute. After you switch off the cooking zone, the ventilation system continues to run for a few minutes in order to remove any cooking vapours. The ventilation system then switches off automatically.

When you switch off all cooking zones, **F** and **⌘** light up. The fan run-on is switched on.

When you switch on a cooking zone, the fan run-on is switched off.

Switching off the fan run-on

- ▶ Use **—** to set the required power level **1**.
- ✓ This immediately stops the fan run-on.

9.11 Switching on intermittent ventilation

For intermittent ventilation, the appliance switches on the ventilation for six minutes per hour each time.

Requirement: A power level is selected.

- ▶ Press **+** or **—** repeatedly until **⌘** lights up.
- ✓ The intermittent ventilation is activated.

Note: If you switch off the appliance, the intermittent ventilation is switched on.

9.12 Switching off intermittent ventilation

- ▶ Use **—** to set the required power level **1**.
- ✓ The intermittent ventilation is switched off.

9.13 Changing the colour of the illuminated ring

Note: The illuminated ring on the control knob lights up orange during operation. You can choose between a lighter and a darker orange.

1. Carry out the following operating steps without interruption.
2. Push in the control knob and turn it anti-clockwise to the **>>** position.
Leave the control knob pushed in.
3. Turn the control knob clockwise to **1**.

Leave the control knob pushed in.

4. Turn the control knob anti-clockwise to **0**.

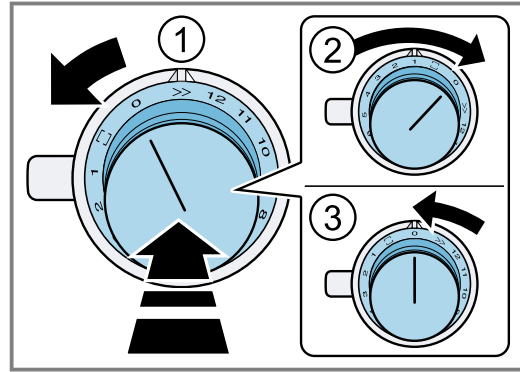

- ✓ **⌘** lights up.
- ✓ The illuminated ring on the control knob lights up yellow.
- ✓ The menu for changing from orange is open.
- 5. Push in the control knob and turn it clockwise to **1**.
- ✓ After approx. 5 seconds, the illuminated ring on the control knob lights up green.
- ✓ The colour has changed.

Changing the colour back

Requirement: You are in the menu for changing the orange colour.

→ "Changing the colour of the illuminated ring", Page 14

- ▶ To change the setting back, push in the control knob and turn it anti-clockwise to **0** and back to **1**.
- ✓ The illuminated ring on the control knob lights up green.

Exiting the menu and saving the settings

1. Push in the control knob and turn it anti-clockwise to the **>>** position.
Leave the control knob pushed in.
2. Turn the control knob clockwise to **1**.
Leave the control knob pushed in.
3. Turn the control knob anti-clockwise to **0**.
- ✓ The illuminated ring on the control knob goes out.
- ✓ The settings are saved.

10 Flex Zone

You can use the Flex cooking zone as a single cooking zone or as two independent cooking zones. The Flex cooking zone consists of four inductors. The inductors work independently of each other and only activate the area of the hob that is covered by the cookware.

10.1 Cookware positions for a single cooking zone

This is where you can find an overview of the positioning of the cookware.

In order to guarantee good pot detection and heat distribution, position the cookware in the centre.

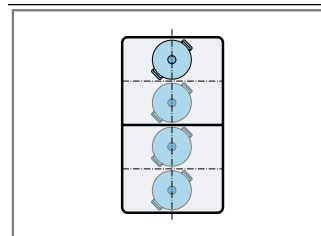

For a diameter of up to 13 cm, position the cookware on one of the four positions as shown in the illustration.

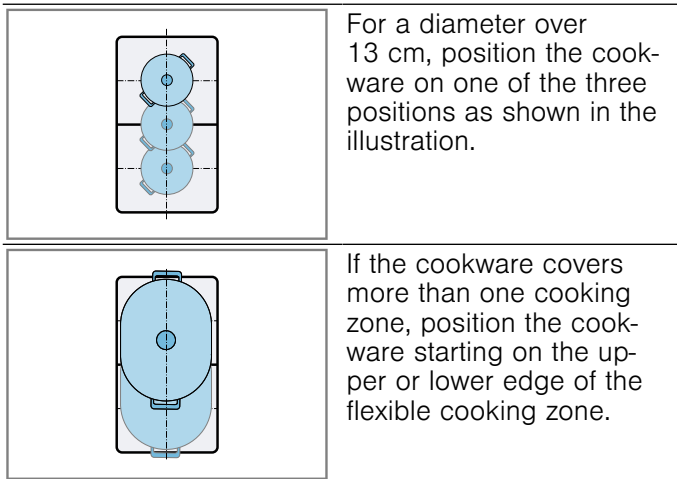

For a diameter over 13 cm, position the cookware on one of the three positions as shown in the illustration.

If the cookware covers more than one cooking zone, position the cookware starting on the upper or lower edge of the flexible cooking zone.

10.2 Cookware positions for two independent cooking zones

This is where you can find an overview of the positioning of the cookware.

You can use the front and rear cooking zones with two inductors each independently of each other. Set the required power level for each individual cooking zone.

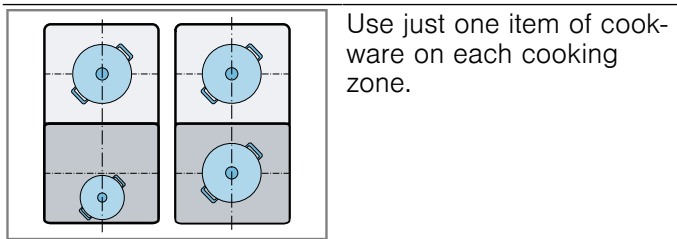

Use just one item of cookware on each cooking zone.

10.3 Using the Flex cooking zone as a single cooking zone

Requirement: The cooking zones are connected.
→ "Connecting the two cooking zones", Page 15

- ▶ Use the entire cooking zone.

11 FlexPlus Zone

The hob has two FlexPlus cooking zones that are located beside the flexible cooking zones and that operate in conjunction with the respective right- or left-hand Flex cooking zone. As a result, you can use larger cookware and achieve improved cooking results.

Each of the two FlexPlus cooking zones is always activated in conjunction with the respective right- or left-hand Flex cooking zone. You cannot activate the FlexPlus cooking zone and the Flex cooking zone separately.

11.1 Information on the positioning of the cookware

This is where you can find an overview of the positioning of the cookware.

Connecting the two cooking zones

1. Set down the cookware.
2. Turn one of the control knobs to \square .
3. Use the other control knob to select the power level.
 - ✓ \square lights up.
 - ✓ The power level lights up in the displays for both cooking zones.
 - ✓ The Flex cooking zone has been activated.

Changing the power level

- ▶ Change the power level using the same control knob that you used to select the power level.

Adding new cookware

1. Set down the new cookware.
2. Turn the control knob that you used to select the Flex cooking zone to 0 and then to \square .
 - ✓ The new cookware is detected and the heat setting that was previously selected is retained.

Note: If you move cookware on the cooking zone that is being used or lift it, the hob starts an automatic search and the heat setting that was previously selected is retained.

Separating the cooking zones

- ▶ Turn the control knob that you used to select the Flex cooking zone to 0.
- ✓ The \square display lights up.
- ✓ The Flex cooking zone is deactivated.
- ✓ The two cooking zones operate as two independent cooking zones.

Note: If you switch off the cooking zone and switch it back on again, the flexible cooking zone is switched back to two independent cooking zones.

10.4 Using the Flex cooking zone as two independent cooking zones

- ▶ Use the Flex cooking zone as two independent cooking zones.
→ "Basic operation", Page 12

Depending on the size of the cookware and the covered cooking surface, you can activate the flexible cooking zone as two independent cooking zones or as one cooking zone.

→ "Flex Zone", Page 14

In order to guarantee good pot detection and heat distribution, position the cookware in the centre. Ensure that the cookware covers the side cooking zone and the FlexPlus cooking zone.

Do not use the Teppan Yaki or the griddle plate with the FlexPlus cooking zone.

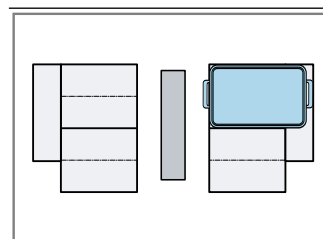

Oblong cookware: Activate the flexible cooking zone as two independent cooking zones.

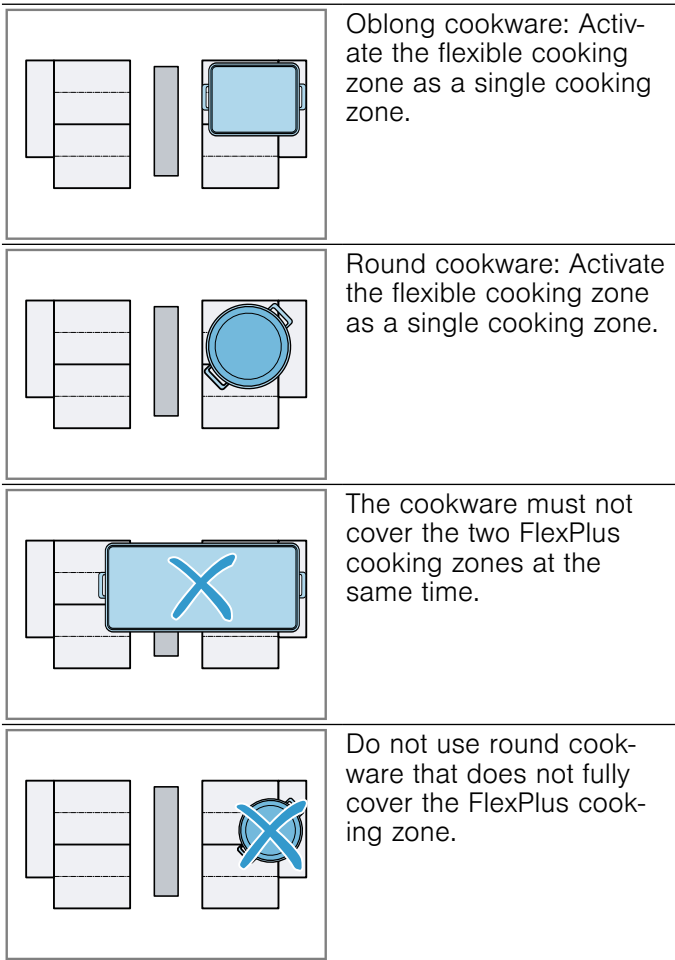

2. Ensure that the cookware covers the FlexPlus cooking zone.

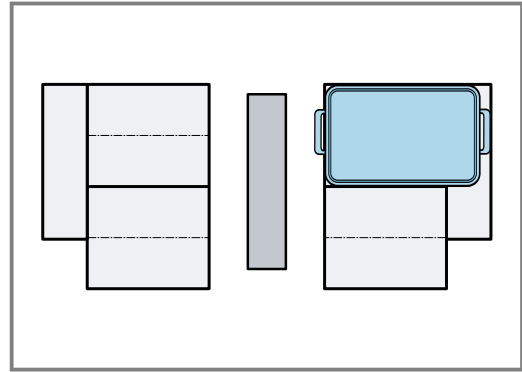

3. Select the cooking zone and the required power level.
 - ✓ The displays for the cooking zone and the FlexPlus cooking zone light up.

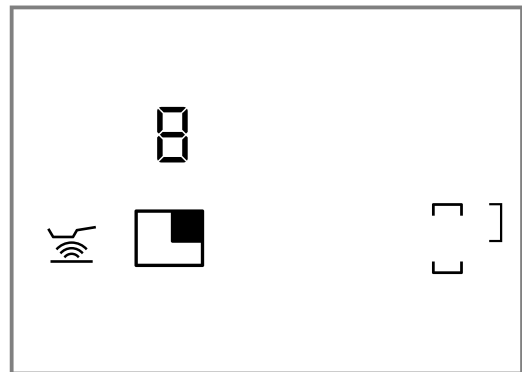

- ✓ The FlexPlus cooking zone is activated.

11.2 Activating the FlexPlus cooking zone

1. Place the cookware on the cooking zone.

11.3 Deactivating FlexPlus Zone

- ▶ Remove the cookware from the cooking zone.
- ✓ *H* or *h* lights up.
- ✓ The display in the FlexPlus cooking zone lights up until the residual heat indicator goes out.
- ✓ The FlexPlus cooking zone is deactivated.

12 Timer function

Your appliance comes with various functions for setting the cooking time.

12.1 Kitchen timer

You can use the kitchen timer to set a time of up to 99 minutes, after which a signal sounds. The kitchen timer runs independently of all other settings and does not automatically switch off a cooking zone.

Setting the kitchen timer

1. Press **⌘**.
 - ✓ **00**, **-** and **+** light up.

2. Within the next 10 seconds, use **-** and **+** to select the desired time.
 - In order to set the time more quickly, press and hold **-** or **+**.

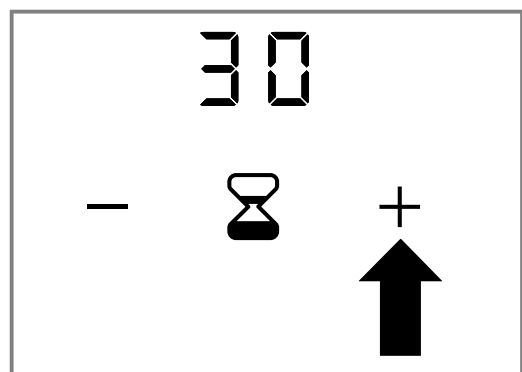

3. Press **⌘**.
 - ✓ The selected time is confirmed.

- ✓ The time begins to count down.

Changing the kitchen timer

1. Press **⌘**.
2. Use **-** and **+** to change the time.
3. Press **⌘**.

- ✓ The selected time is confirmed.

Deleting the kitchen timer

1. Press **⌘**.
2. Use **-** and **+** to set the time to **00**.
3. Press **⌘**.

- ✓ The time is deleted.

Switching off the kitchen timer

Requirement: Once the time has elapsed, an audible signal sounds. **00** flashes.

- ▶ Press **⌘**.
- ✓ The display goes out.
- ✓ The audible signal stops.

12.2 Stopwatch function

The stopwatch function shows the time (in minutes and seconds (mm.ss)) that has elapsed since the function was activated. The stopwatch function operates independently of all the other settings and does not automatically switch off a cooking zone.

13 Booster function

You can use the booster function to heat up large volumes of water more quickly than with power level **i2**.

The booster function is available for all cooking zones, provided the other cooking zone in the same group is not in use.

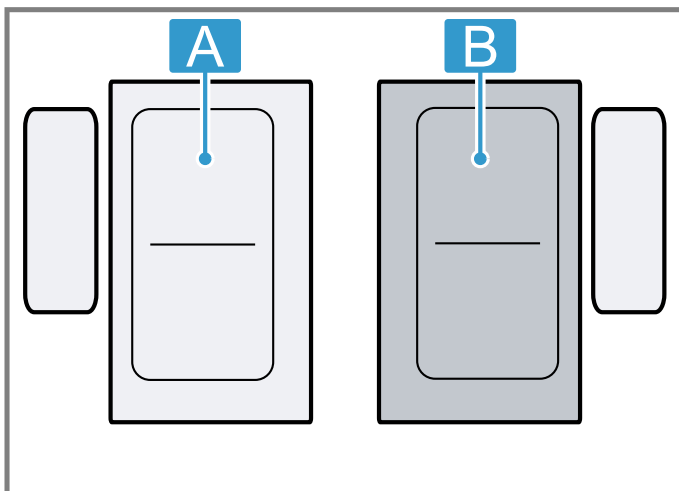

A Group for left-hand hob

B Group for right-hand hob

If the other cooking zone in the same group is operating, **P** and **i2** flash on the display for the selected cooking zone. The appliance then automatically switches on

The maximum time is **99** minutes and **59** seconds (**99.59**). Once this value is reached, the display goes back to **00.00**.

Activating the stopwatch function

1. Select the power level.
 - ✓ **⌘** lights up.
2. Press **⌘**.
 - ✓ **00.00** lights up.
 - ✓ The cooking time counts down.

Interrupting the stopwatch function

1. Press **⌘**.
 - ✓ The stopwatch function is stopped.
 - ✓ The stopwatch displays continue to light up.
2. Press **⌘**.
 - ✓ The time in the display continues to count down.

Deactivating the stopwatch function

- ▶ Press and hold **⌘**.
- ✓ The stopwatch function is stopped.
- ✓ The stopwatch displays go out.
- ✓ The stopwatch function has now been deactivated.

power level **i2** without activating the booster function. In this case, turn the control knob for the other cooking zone to **0**.

Note: For the FlexZone, you can activate the function even if you use this as a single cooking zone.

13.1 Activating the booster function

- ▶ Push in the control knob and turn it to **>>**.

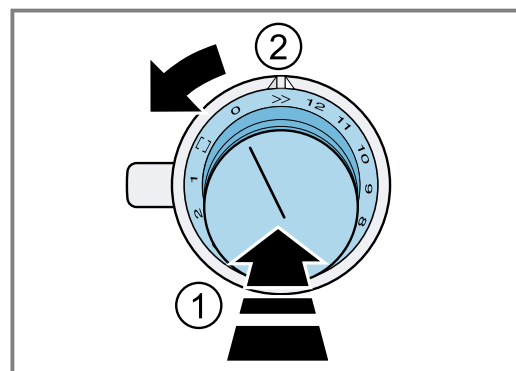

- ✓ **P** and **>>** light up.
- ✓ The function has now been activated.

13.2 Deactivating the booster function

- ▶ Push in the control knob and turn it to the required power level.
 - ✓ **P** and **>>** go out.
 - ✓ The selected power level lights up.
 - ✓ The function has now been deactivated.

Note: In certain circumstances, the booster function automatically switches off in order to protect the electronic elements inside the hob. In this case, the appliance automatically sets power level *i*².
→ "Deactivating the booster function after the safety switch-off", Page 18

13.3 Deactivating the booster function after the safety switch-off

Requirement: The appliance has automatically set power level *i*².

- ▶ Turn the control knob to 0 or a required power level.

14 Frying sensor function

If you are frying food, use this function to maintain the suitable pan temperature. The cooking zones that have this function are identified by the roasting sensor function symbol.

14.1 Advantages when frying

- The cooking zone only continues heating for as long as this is necessary to maintain the temperature. This saves energy and prevents the oil or fat from overheating.
- The frying sensor function reports when the empty pan has reached the optimum temperature for adding oil and then for adding the food.

Notes

- Do not place a lid on the pan. Otherwise, the function is not activated correctly. Use a splatter guard to prevent fat from spitting out.
- Use oil or fat that is suitable for stir fries. If you are using butter, margarine, cold-pressed olive oil or lard, use temperature setting *i* or *2*.
- Never leave a frying pan unattended during heating, regardless of whether or not it contains food.
- If the cooking zone is a higher temperature than the cookware or vice versa, the frying sensor is not activated correctly.

14.2 Temperature levels

| Level | Suitable for |
|----------|--|
| <i>i</i> | Very low Preparing and reducing sauces, stewing vegetables and frying food in extra virgin olive oil, butter or margarine. |
| <i>2</i> | Low Frying food in extra virgin olive oil, butter or margarine, e.g. omelettes. |
| <i>3</i> | Low - Medium Frying fish and thick food such as meatballs and sausages. |
| <i>4</i> | Medium - High Frying steaks (well done), breaded frozen products, and thin food such as schnitzel, strips of meat and vegetables. |
| <i>5</i> | High Frying food at high temperatures, e.g. steaks (rare or medium), potato fritters and fried potatoes |

14.3 Recommended cookware

Special cookware has been developed for this function, which delivers the best results.

The recommended cookware is available from customer service, specialist retailers or our online shop www.gaggenau.com.

Note: You can also use other cookware. Depending on the composition of the cookware, the achieved temperature may differ from the selected temperature level.

14.4 Settings for cooking with the frying sensor

The table shows which temperature level *l* is suitable for which food. The frying time (⌚ min) may vary depending on the type, weight, thickness and quality of the food.

The set temperature level varies depending on the cookware that is used. Preheat the empty pan. Add oil and the food after the signal tone sounds.

| | <i>l</i> | ⌚ min |
|---|----------|---------|
| Meat | | |
| Escalope, plain ¹ | 4 | 6-10 |
| Escalope, breaded ¹ | 4 | 6-10 |
| Fillet ² | 4 | 6-10 |
| Chops ¹ | 3 | 10-15 |
| Cordon bleu ¹ | 4 | 10 - 15 |
| Wiener schnitzel ¹ | 4 | 10-15 |
| Steak, rare, 3 cm thick ² | 5 | 6-8 |
| Steak, medium, 3 cm thick ² | 5 | 8-12 |
| Steak, well done, 3 cm thick ¹ | 4 | 8-12 |
| Poultry breast, 2 cm thick ¹ | 3 | 10-20 |
| Meat cut into strips ³ | 4 | 7-12 |
| Gyros ³ | 4 | 7-12 |
| Bacon ¹ | 2 | 5 - 8 |
| Minced meat ³ | 4 | 6-10 |
| Hamburgers, 1.5 cm thick ¹ | 3 | 6-10 |
| Patties, 2 cm thick ¹ | 3 | 10-20 |
| Filled rissoles ¹ | 3 | 10-20 |
| Boiled sausages ¹ | 3 | 8-20 |
| Fresh sausages ¹ | 3 | 8-20 |

¹ Turn frequently.

² Add oil and the food after the signal tone.

³ Stir regularly.

⁴ Add butter and the food after the signal tone sounds.

⁵ Cooking time per serving. Fry one portion after the other.

⁶ Add water after the signal tone. As soon as the water has boiled, add the food.

⁷ Add the food after the signal tone sounds.

| | ⌘ | ⌚ min |
|---|---|---------|
| Fish | | |
| Fish fillet, plain ¹ | 4 | 10-20 |
| Fish fillet, breaded ¹ | 3 | 10-20 |
| Scampi ¹ | 4 | 4 - 8 |
| Prawns ¹ | 4 | 4 - 8 |
| Fish, fried, whole ¹ | 3 | 10-20 |
| Egg dishes | | |
| Fried eggs in butter ⁴ | 2 | 2-6 |
| Fried eggs ² | 4 | 2-6 |
| Scrambled eggs ³ | 2 | 4-9 |
| Omelette ⁵ | 2 | 3-6 |
| Pancakes ⁵ | 5 | 1,5-2,5 |
| French toast ⁵ | 3 | 4-8 |
| Raisin pancake ⁵ | 3 | 10-15 |
| Vegetables and legumes | | |
| Garlic ³ | 2 | 2-10 |
| Onions, braised ³ | 2 | 2-10 |
| Onion rings ³ | 3 | 5-10 |
| Courgette ¹ | 3 | 4-12 |
| Aubergine ¹ | 3 | 4-12 |
| Peppers ¹ | 3 | 4-15 |
| Green asparagus ¹ | 3 | 4-15 |
| Mushrooms ³ | 4 | 10-15 |
| Vegetables, braised in oil ³ | 1 | 10-20 |
| Vegetables, glazed ³ | 3 | 6-10 |
| Potatoes | | |
| Fried potatoes, boiled in their skin ³ | 5 | 6-12 |
| Chips (made from raw potatoes) ³ | 4 | 15-25 |
| Potato pancakes ⁵ | 5 | 2,5-3,5 |
| Swiss rösti ⁴ | 2 | 50-55 |
| Glazed potatoes ³ | 3 | 10-15 |
| Sauces | | |
| Tomato sauce with vegetables ³ | 1 | 25-35 |
| Béchamel sauce ³ | 1 | 10-20 |
| Cheese sauce ³ | 1 | 10-20 |
| Reducing sauces ³ | 1 | 25-35 |
| Sweet sauces ³ | 1 | 15-25 |
| Frozen products | | |
| Escalope ¹ | 4 | 15-20 |
| Cordon bleu ¹ | 4 | 10 - 30 |

¹ Turn frequently.

² Add oil and the food after the signal tone.

³ Stir regularly.

⁴ Add butter and the food after the signal tone sounds.

⁵ Cooking time per serving. Fry one portion after the other.

⁶ Add water after the signal tone. As soon as the water has boiled, add the food.

⁷ Add the food after the signal tone sounds.

| | ⌘ | ⌚ min |
|---------------------------------------|---|-------|
| Poultry breast ¹ | 4 | 10-30 |
| Chicken nuggets ¹ | 4 | 10-15 |
| Gyros ³ | 4 | 10-15 |
| Kebab ³ | 4 | 10-15 |
| Fish fillet, plain ¹ | 3 | 10-20 |
| Fish fillet, breaded ¹ | 3 | 10-20 |
| Fish fingers ¹ | 4 | 8-12 |
| Chips, in the frying pan ³ | 5 | 4-6 |
| Stir-fries ³ | 3 | 6-10 |
| Spring rolls ¹ | 4 | 10-30 |
| Camembert ¹ | 3 | 10-15 |
| Other | | |
| Fried cheese ¹ | 3 | 7-10 |
| Croutons ³ | 3 | 6-10 |
| Dried ready meals ⁶ | 1 | 5-10 |
| Almonds, roasted ⁷ | 4 | 3-15 |
| Nuts, roasted ⁷ | 4 | 3-15 |
| Pine nuts, toasted ⁷ | 4 | 3-15 |

¹ Turn frequently.

² Add oil and the food after the signal tone.

³ Stir regularly.







⁴ Add butter and the food after the signal tone sounds.

⁵ Cooking time per serving. Fry one portion after the other.

⁶ Add water after the signal tone. As soon as the water has boiled, add the food.

⁷ Add the food after the signal tone sounds.

14.5 Switching on the frying sensor

- Select the appropriate frying setting.
→ "Settings for cooking with the frying sensor", Page 18
- Place the empty cookware on the cooking zone.
- Use the control knob to select the required temperature level.
For this function, the temperature levels 1 to 5 are available.
→ "Temperature levels", Page 18
If you select a temperature setting above 5, the appliance sets the temperature level 5.
- Press .
✓  lights up orange.
✓  and the selected temperature level light up.
✓ The function has now been activated.
✓ ,  and  light up until the selected temperature level is reached. An audible signal then sounds and the temperature display goes out.
- Once the frying temperature has been reached, add the oil and then the food to the pan.
- Turn the food so that it does not burn.

14.6 Switching off the frying sensor

- ▶ Turn the control knob that you used to select the temperature to 0.
- ✓ The cooking zone is switched off.
- ✓ The residual heat indicator lights up.

15 Automatic switch-off

If you operate a cooking zone for an extended period and do not change any settings, the automatic safety shut-off is activated. Depending on which performance level has been selected, the cooking zone switches off automatically after 1 to 10 hours.

An audible signal sounds when this time has elapsed. The illuminated ring on the activated control knob flashes. *FB* lights up. The cooking zone stops heating.

15.1 Switching on the appliance again after the automatic safety switch-off

1. Turn the control knob to 0.
2. Turn the control knob for the required cooking zone to the power level.

15.2 Switch-on time depending on the power levels

The following overview displays the number of hours after which the hob is switched off, depending on the selected power level.

| Power level | Number of hours |
|-------------|-----------------|
| 1 | 10 |
| 2 to 4 | 5 |
| 5 to 7 | 4 |
| 8 | 3 |
| 9 to 10 | 2 |
| 11 to 12 | 1 |

If you activate the frying sensor, the hob switches off at power levels 1 to 5 after three hours.

16 Locking the control panel for cleaning

You can use this function to lock the control panel for cleaning for a short time. You can remove liquids that have boiled over without changing the settings you have selected on the activated hob.

The function has no effect on the control knob. You can switch off the appliance at any time. The power supply to the appliance is interrupted while the lock is on. The cooking zones may still be hot. The ventilation continues.

16.1 Activating the lock on the control panel for cleaning purposes

- ▶ Press .
- ✓ An audible signal sounds.

- ✓ The display for the previously activated functions flashes.
- ✓ The control panel is locked for 10 minutes.
- ✓ The appliance stops heating.
- ✓ The ventilation system continues to run.
- ✓ The timer is paused.
- ✓ The appliance switches off if you do not deactivate the function within the next 10 minutes.

16.2 Deactivating the lock on the control panel for cleaning purposes

- ▶ Press .
- ✓ The function has now been deactivated.

17 Basic settings

You can configure the basic settings for your appliance to meet your needs.

17.1 Overview of the basic settings

This is where you can find an overview of the basic settings and the factory preset values.

| Display | Selection |
|---------|---|
| c1 | Audible signals <i>ON</i> All signal tones are switched on. ¹ <i>OFF</i> Only the fault signal is switched on. |

¹ Factory setting

| Display | Selection |
|---------|---|
| c2 | Power management function. Limit the total power of the hob. The available settings depend on the maximum power of the hob. <i>OFF</i> Deactivated. ¹ <i>1000</i> Lowest level. <i>1500</i> <i>2000</i> ... <i>9500</i> Highest level for the hob. |
| c3 | Check cookware; cooking results → "Cookware test", Page 24 <i>0</i> Not suitable. <i>!</i> Not optimal. <i>2</i> Suitable. |

¹ Factory setting

| Display | Selection |
|---------|---|
| c4 | Setting air recirculation mode or air extraction mode <i>0</i> Air recirculation mode is set. ¹ <i>1</i> Air extraction mode is set. |
| c5 | Automatic ventilation start <i>OFF</i> Switched off. The ventilation must be switched on manually if required. <i>A</i> Switched on in automatic mode. ¹ The ventilation switches itself on when you switch on a cooking zone in automatic mode. <i>1/2/3</i> Switched on in manual mode. The ventilation is switched on with a fixed power level when a cooking zone is switched on. |
| c6 | Fan run-on <i>A</i> Fan run-on in automatic mode. ¹ <i>00</i> Fan run-on with last selected setting. <i>OFF</i> The ventilation system is switched off with the hob. Not recommended for appliances with air recirculation mode. |
| c7 | Setting the sensor sensitivity for the ventilation <i>1</i> Lowest sensor sensitivity setting. <i>2</i> Medium sensor sensitivity setting. ¹ <i>3</i> Highest sensor sensitivity setting. |
| c8 | Restoring to the factory settings <i>OFF</i> Individual settings retained. ¹ <i>00</i> Restore to the factory settings. |

¹ Factory setting

17.2 Opening the basic settings menu

Requirement: The hob is switched off.

1. Push in any control knob. While the control knob is pushed in, carry out the following steps without interruption:
 - Turn the control knob one notch anti-clockwise to position >> ①.
 - Turn the control knob three notches clockwise to position 1 ②.
 - Turn the control knob two notches anti-clockwise to position 0 ③.

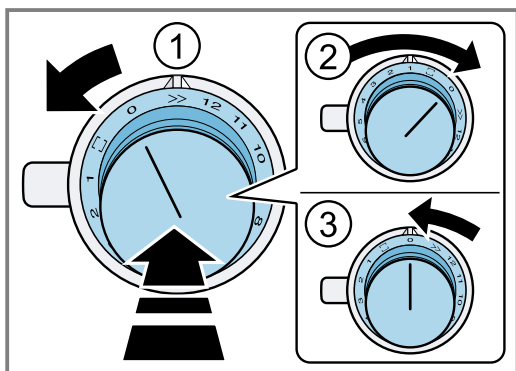

- ✓ *0* lights up.
 - ✓ The illuminated ring on the control knob lights up yellow.
2. Press *0*.
The displays show the product information.

| Product information | Display |
|------------------------|---------|
| Customer Service Index | 01 |
| Production number | Fd |
| Production number 1 | 01 |
| Production number 2 | 05 |

3. Press *0* again.

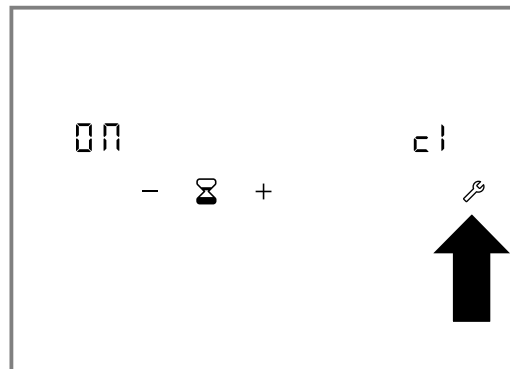

- ✓ The basic settings menu is opened.
 - ✓ *c1* and *00* light up.
4. Press *0* repeatedly until the required function is displayed.
 5. Use + and – to select the required setting.

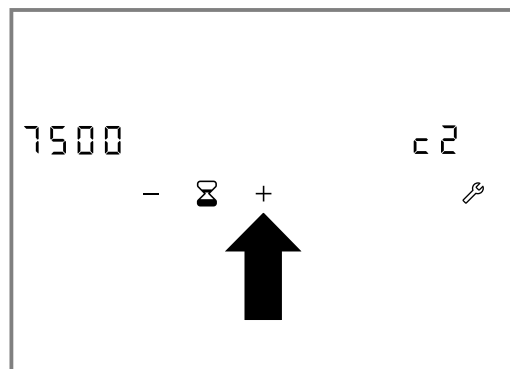

6. Press and hold *0* for at least 4 seconds.
 7. Exit the basic settings menu. → Page 22
- ✓ The settings are saved.

17.3 Exiting the basic settings menu

- ▶ Push the control knob in. While the control knob is pushed in, carry out the following steps without interruption:
 - Turn the control knob one notch anti-clockwise to position >> ①.
 - Turn the control knob three notches clockwise to position 1 ②.
 - Turn the control knob two notches anti-clockwise to position 0 ③.

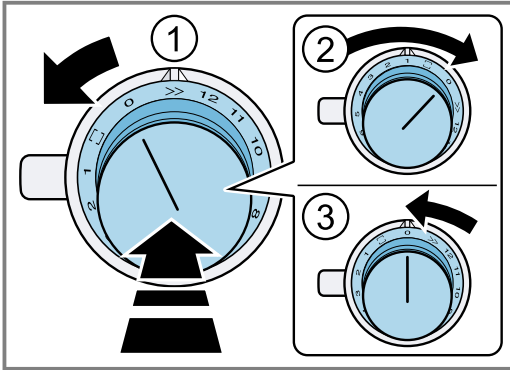

- ✓ The appliance saves the changed settings.
- ✓ 🔑 goes out.
- ✓ The illuminated ring on the control knob goes out.

Note: If you do not carry out the operating steps, the appliance does not save the changed settings.

18 Home Connect

This appliance is network-capable. Connecting your appliance to a mobile device lets you control its functions via the Home Connect app, adjust its basic settings and monitor its operating status.

The Home Connect services are not available in every country. The availability of the Home Connect function depends on the availability of Home Connect services in your country. You can find information about this at: www.home-connect.com.

The Home Connect app guides you through the entire login process. Follow the instructions in the Home Connect app to configure the settings.

Tip: Please also follow the instructions in the Home Connect app.

Notes

- Please note the safety precautions in this instruction manual and make sure that they are also observed when operating the appliance via the Home Connect app.
→ "Safety", Page 3
- Operating the appliance on the appliance itself always takes priority. During this time it is not possible to operate the appliance using the Home Connect app.
- In networked standby mode, the appliance requires a maximum of 2 W.
- Hobs are not designed to be left unattended. Always monitor the cooking process.

18.1 Setting up the Home Connect app

1. Install the Home Connect app on your mobile device.

2. Start the Home Connect app and set up access for Home Connect.
The Home Connect app guides you through the entire login process.

18.2 Setting up Home Connect

Requirements

- The appliance is connected to the power supply and is switched on.
- You have a mobile device with a current version of the iOS or Android operating system, e.g. a smartphone.
- The Home Connect app has been installed on your mobile device.
- The appliance is receiving signals from the WLAN home network (Wi-Fi) at its installation location.
- The mobile device and the appliance are within range of your home network's Wi-Fi signal.

1. Open the Home Connect app and scan the following QR code.



2. Follow the instructions in the Home Connect app.

18.3 Changing the Home Connect settings

In the Home Connect settings menu, you can connect your appliance to Home Connect and implement the setting for connecting to the Wi-Fi home network.

1. Push in any control knob. While the control knob is pushed in, carry out the following steps without interruption:
 - Turn one notch anti-clockwise to >> ①.
 - Turn the control knob two notches clockwise to □ ②.
 - Turn the control knob one notch anti-clockwise to 0 ③.

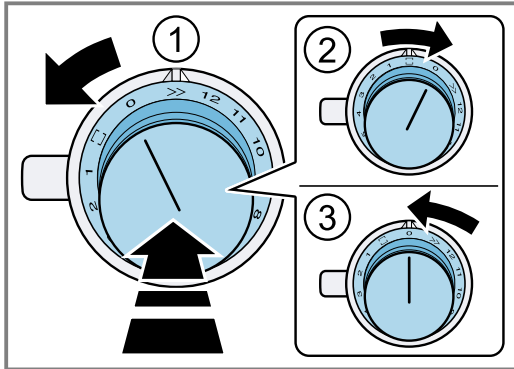

- ✓ The illuminated ring on the control knob lights up blue.

2. In order to implement a setting, turn the control knob to the required position.
→ "Overview of the Home Connect settings", Page 23
3. To save the setting, exit the Home Connect settings menu in the same way.
 - Turn one notch anti-clockwise to >> ①.
 - Turn the control knob two notches clockwise to □ ②.
 - Turn the control knob one notch anti-clockwise to 0 ③.

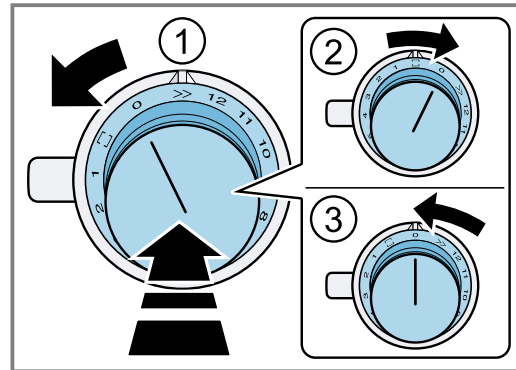



18.4 Overview of the Home Connect settings

In the Home Connect settings, you can adjust settings and network settings for Home Connect.

| Knob position | Setting | Use |
|---------------|---|--|
| | Manual login in the Wi-Fi home network | To log in manually, you require the network name (SSID) and password (key) for your Wi-Fi home network. On your mobile device, the Home Connect Wi-Fi connection is available for approximately 20 minutes. |
| | Automatic login in the Wi-Fi home network | Login to the Wi-Fi home network with a WPS-enabled router |
| | Switching the Wi-Fi on or off | You can switch off the Wi-Fi connection on your hob at any time, e.g. to save energy during a holiday. The connections to the home network remain saved. When you switch the Wi-Fi back on, the saved connections are applied. |
| | Resetting the Home Connect connection | You can delete all of the settings for Home Connect, e.g. if you have new access data for your router. |

18.5 Switching Wi-Fi on or off

1. Open the Home Connect settings menu.
→ *"Changing the Home Connect settings", Page 22*
- ✓ The illuminated ring on the control knob lights up blue.
2. Turn the control knob to the **3** position.
- ✓ The illuminated ring on the control knob lights up green.
- ✓ After approx. 5 seconds, the illuminated ring on the control knob flashes blue.
- ✓ After a few seconds, the illuminated ring on the control knob lights up blue.
- ✓ The  and **WIFI** symbols go out on the control panel. Wi-Fi is deactivated.
3. To save the setting, exit the settings menu in the same way.
4. If you want to switch the Wi-Fi back on, work through the same operating sequence.
- ✓ The illuminated ring on the control knob lights up blue.
- ✓ After approx. 5 seconds, the illuminated ring on the control knob flashes blue and then lights up green.
5. The control panel shows  and **WIFI**.
6. To save the setting, exit the settings menu in the same way.

18.6 Software update

Your appliance's software can be updated using the software update function, e.g. for the purposes of optimisation, troubleshooting or security updates. To do this, you must be a registered Home Connect user, have installed the app on your mobile device and be connected to the Home Connect server. As soon as a software update is available, you will be informed via the Home Connect app and will be able to start the software update via the app. Once the update has been successfully downloaded, you can start installing it via the Home Connect app if you are in your home network (Wi-Fi). The Home Connect app informs you once installation is successful.

Notes

- The software update consists of two steps.
 - The first step is the download.
 - The second step is the installation on your appliance.

- You can continue to use your appliance as normal while updates are downloading. Depending on your personal settings in the app, software updates can also be set to download automatically.
- Installation takes a few minutes. You cannot use your appliance during installation.
- We recommend that you install security updates as soon as possible.

18.7 Remote diagnostics

Customer Service can use Remote Diagnostics to access your appliance if you contact them, have your appliance connected to the Home Connect server and if Remote Diagnostics is available in the country in which you are using the appliance.

Tip: For further information and details about the availability of Remote Diagnostics in your country, please visit the service/support section of your local website: www.home-connect.com.

18.8 Data protection

Please see the information on data protection.

The first time your appliance is registered on a home network connected to the Internet, your appliance will transmit the following types of data to the Home Connect server (initial registration):

- Unique appliance identification (consisting of appliance codes as well as the MAC address of the installed Wi-Fi communication module).
- Security certificate of the Wi-Fi communication module (to ensure a secure data connection).
- The current software and hardware version of your appliance.
- Status of any previous resetting to factory settings.

This initial registration prepares the Home Connect functions for use and is only required when you want to use the Home Connect functions for the first time.

Note: Please note that the Home Connect functions can only be utilised with the Home Connect app. Information on data protection can be retrieved in the Home Connect app.

19 Cookware test

You can use this function to check the speed and quality of the cooking process depending on the cookware. The result is a reference value and depends on the properties of the cookware and the cooking zone being used.

You can find more information about this function under

- *"Basic settings", Page 20* and on the type, size and positioning of the cookware under
- *"Induction cooking", Page 7* and
- *"Flex Zone", Page 14*.

19.1 Checking the cookware

1. At room temperature, place the cookware with approx. 200 ml water in the centre of the cooking zone whose diameter best fits the diameter of the base of the cookware.
2. Open the basic settings menu → *Page 21*.
3. Select the **c3** setting.
 - ✓ **FFF** lights up.
4. Press **+** or **-**.
 - ✓ **07** lights up.
 - ✓ An audible signal sounds.
 - ✓ The displays for the cooking zones light up.
 - ✓ The function has now been activated.

- ✓ *FUN* lights up.
- ✓ After a few seconds, the results for the quality and speed of the cooking process are displayed.

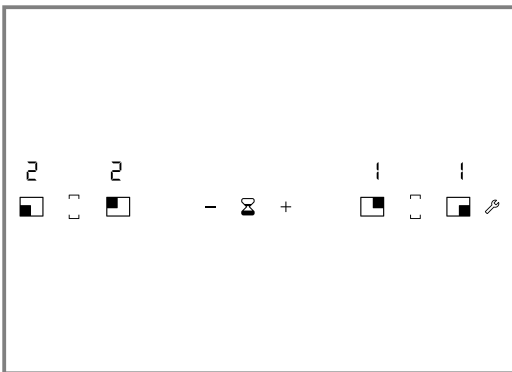

Notes

- If the cooking zone is much smaller than the diameter of the cookware, only the middle of the cookware heats up. The cooking result will not be optimal.

- The flexible cooking zone is set to function as a single cooking zone; check only one item of cookware.
- Do not use the wok and wok accessories for this function.

19.2 Checking the result

- ▶ Check the quality result and the speed of the cooking process using the following overview.

| Display | Result |
|---------|--|
| | The cookware is not suitable for the cooking zone and therefore does not heat up. ¹ |
| | The cookware is taking longer to heat up than expected and cooking is not progressing as well as it ought to. ¹ |
| | The cookware is heating up correctly and cooking is progressing well. |

¹ If there is a smaller cooking zone available, try the cookware again on the smaller cooking zone.

20 Cleaning and servicing

To keep your appliance working efficiently for a long time, it is important to clean and maintain it carefully.

20.1 Cleaning products

You can obtain suitable cleaning products and glass scrapers from customer service, the online shop or a retailer.

ATTENTION!

Unsuitable cleaning products may damage the surfaces of the appliance.

- ▶ Never use unsuitable cleaning products.
- ▶ Do not use cleaning products while the hob is still hot. This may cause marks on the surface.

Unsuitable cleaning products

- Undiluted detergent
- Detergent intended for dishwashers
- Abrasive cleaners
- Aggressive cleaning products such as oven spray or stain remover
- Abrasive sponges
- High-pressure or steam jet cleaners

20.2 Components to be cleaned or replaced

The following overview shows the components of the appliance that you either replace or clean.

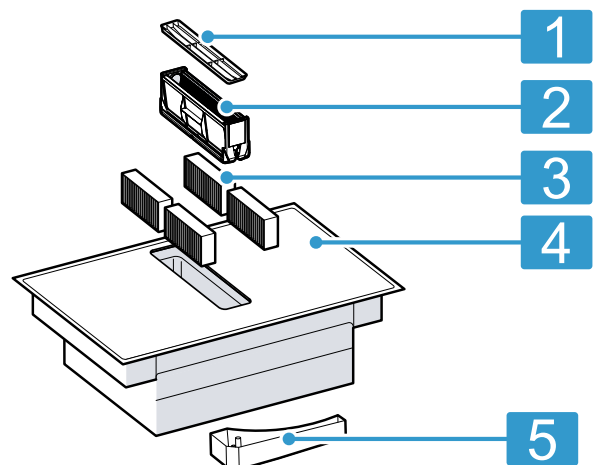

| | |
|--|----------------------------------|
| | Ventilation grille |
| | Grease filter |
| | Odour filter or acoustics filter |
| | Glass ceramic |
| | Overflow container |

20.3 Cleaning the hob

Clean the hob after every use to stop cooking residues from getting burnt on.

Note: Note the information on unsuitable cleaning products. → Page 25

Requirement: The hob has cooled down.

1. Remove heavy dirt using a glass scraper.
2. Clean the hob with a cleaning product for glass ceramic.
Follow the cleaning instructions on the product packaging.

Tip: You can achieve good cleaning results if you use a special sponge for glass ceramic.

20.4 Cleaning the control knob

Note: You cannot remove the knob for cleaning.

1. Clean the control knob with warm soapy water and a soft cloth.
2. Do not use too much water when cleaning.

20.5 Changing the odour filter or acoustics filter

Change the odour filter regularly. Change the acoustics filters if they are dirty.

Note: You can obtain odour filters or acoustics filters from specialist retailers, customer service or in the on-line shop.

1. To keep them in good working order, only use genuine replacement filters.
2. Remove the ventilation grille.

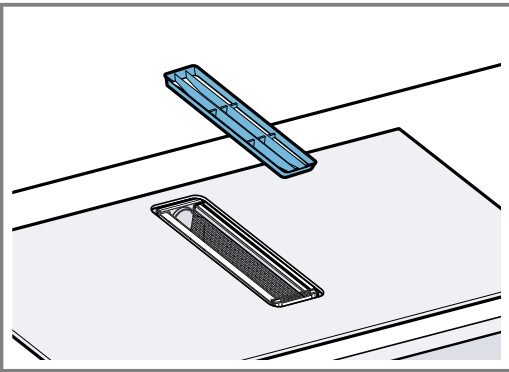

3. ATTENTION!

Falling grease filters may damage the hob below.

- ▶ Grip below the grease filter with one hand.

Remove the grease filter.

- Fat may accumulate in the bottom of the container. Hold the grease filter level to prevent grease from dripping out.

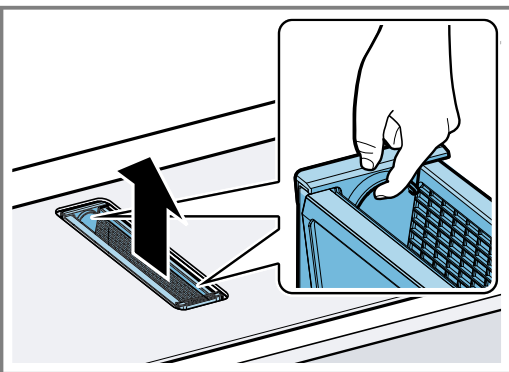

4. Remove the four odour filters or acoustics filters, and dispose of them properly.

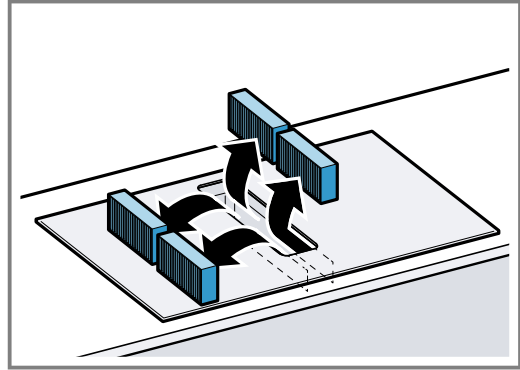

5. Insert two odour filters or acoustics filters into the left and right of the appliance and slide them forwards.

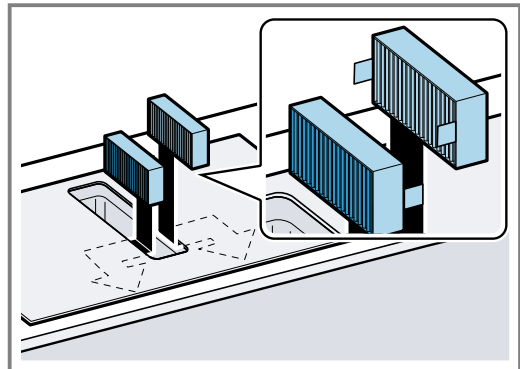

6. Insert the other odour filters or acoustics filters into the left and right of the appliance.

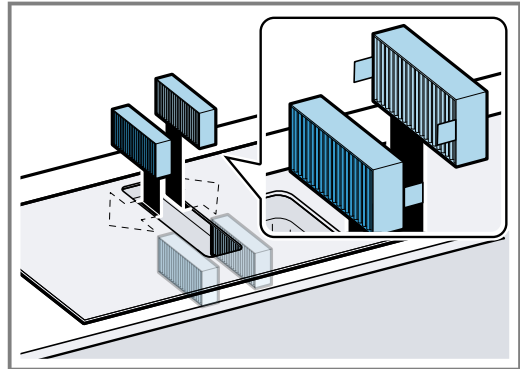

7. Insert the grease filter.

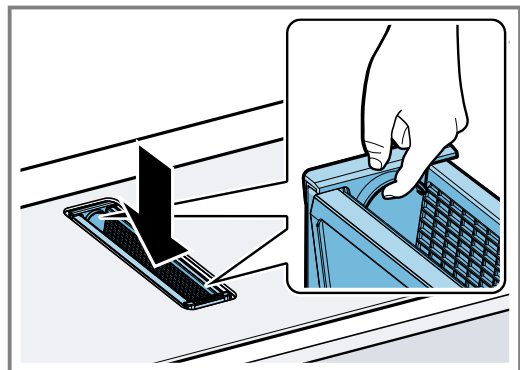

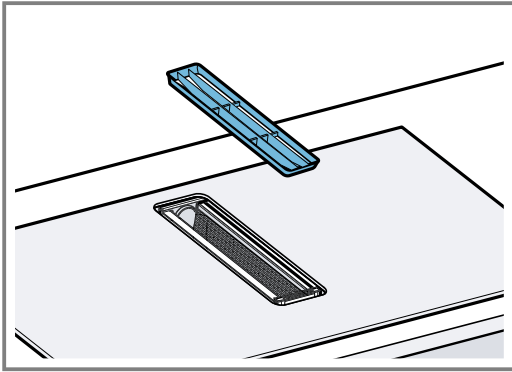

8. Place the ventilation grille on top.



Resetting the saturation indicator

Requirement: After the appliance is switched off,  lights up.

1. Replace the odour filter. → Page 26
 2. Press and hold  for approx. 3 seconds.
- ✓ The  display stops lighting up. The saturation indicator for the odour filters is reset.

20.6 Cleaning the grease filters

Grease filters filter the grease from the cooking vapour. To keep it in good working order, you must clean the grease filter regularly.

WARNING – Risk of fire!

- Fatty deposits in the grease filters may catch fire.
- ▶ Never operate the appliance without a grease filter.
 - ▶ Clean the grease filters regularly.
 - ▶ Never work with naked flames close to the appliance (e.g. flambéing).

1. Remove the ventilation grille.

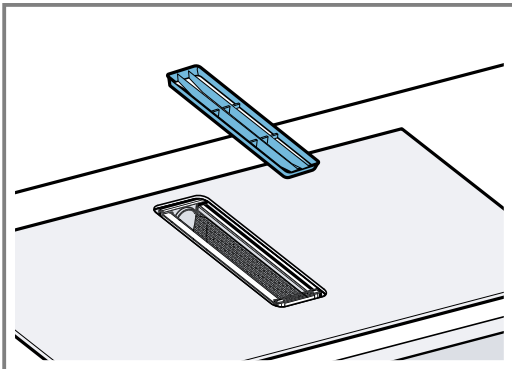

2. **ATTENTION!**

- Falling grease filters may damage the hob below.
- ▶ Grip below the grease filter with one hand.
- Remove the grease filter.
- Fat may accumulate in the bottom of the container. Hold the grease filter level to prevent grease from dripping out.

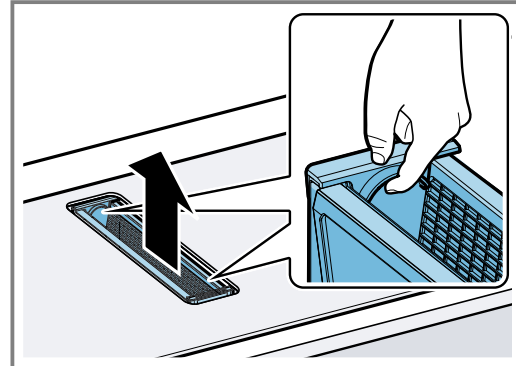

3. Clean the grease filter.
 - → "Cleaning the grease filters manually", Page 27
 - → "Cleaning the grease filter in the dishwasher", Page 28
4. If required, remove the odour filters or acoustics filters and clean the appliance from the inside. → "Changing the odour filter or acoustics filter", Page 26
5. If any objects get into the appliance, remove these objects and ensure that the supply to the overflow container is not blocked.
6. Wipe out the inside of the appliance with soapy water and a dish cloth.
7. After cleaning, reinsert the dried grease filter.
8. Place the ventilation grille on top.

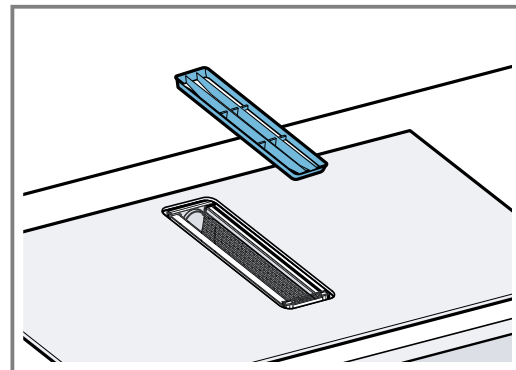

Cleaning the grease filters manually

1. Dismantle the grease filter.

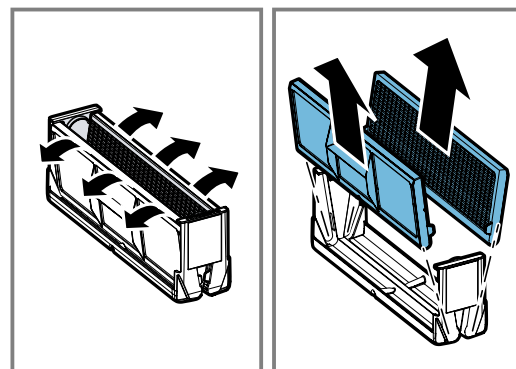

2. Soak the grease filter in hot soapy water.
3. Use a brush to clean the grease filter.
Do not use aggressive, acidic or alkaline cleaning products.
Use special grease solvent for stubborn dirt. You can purchase the grease solvent from the after-sales service, through our online shop or in a specialist shop.
4. Rinse the grease filters thoroughly.
5. Allow the grease filters to drain.

Cleaning the grease filter in the dishwasher

1. For optimum cleaning results, disassemble the grease filter.

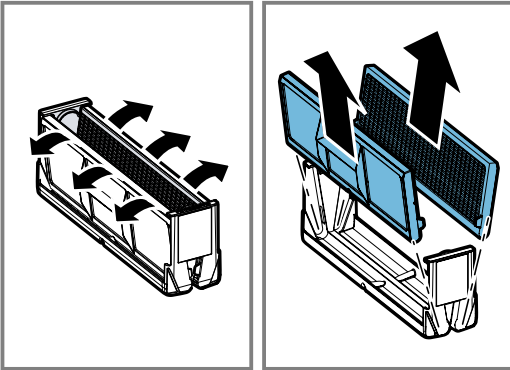

2. Place the individual components of the grease filter loosely in the dishwasher and do not jam them in.

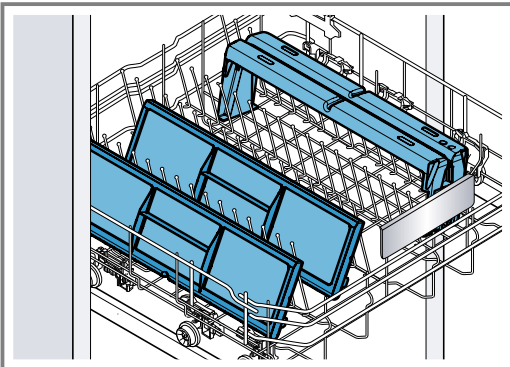

Do not clean heavily soiled grease filters with tableware.
Do not use aggressive, acidic or alkaline cleaning products.

3. Start the dishwasher.
Select a temperature setting below 70 °C.
4. Leave the grease filter to drain.

20.7 Cleaning the ventilation grille

- ▶ Clean the ventilation grille with a damp dish cloth and dry it with a soft cloth, or clean it in the dishwasher.
When cleaning in the dishwasher, the surface may become discoloured. The discolouration does not affect its usability.

20.8 Cleaning the overflow container

The overflow container collects liquids or objects that come into the appliance from above.

Requirement: The appliance has cooled and the residual heat indicator has gone out.

1. Hold the overflow container with one hand and unscrew it with the other hand.
 - Hold the overflow container level to prevent liquid from leaking out.

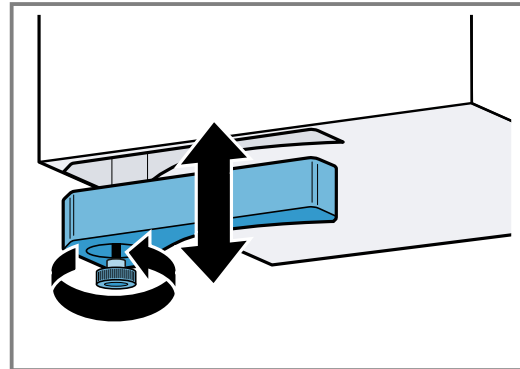

2. Empty the overflow container and rinse it out.
3. If required, unscrew the screw and clean the overflow container without the screw in the dishwasher.
4. Clean the overflow container before screwing it back into place.
5. Ensure that the supply to the overflow container is not blocked.
Remove any objects that have entered the appliance once it has cooled down. To do this, remove the grease filter. → Page 27

21 FAQs

This is where you can find an overview of the frequently asked questions regarding use, noises, cookware and cleaning.

21.1 Using the appliance

| Question | Answer |
|---|--|
| Why are the illuminated displays flashing and why is a signal sounding? | <ul style="list-style-type: none"> ■ Clean the surface of the control panel of any liquids or food residue. Remove any objects that may cover the control panel. You can find further information about deactivating the signal tone under → "Basic settings", Page 20. |

| Question | Answer |
|---|--|
| The ventilation system continues to run even though the cooking zones have been switched off. | <ul style="list-style-type: none"> Manually switch off the ventilation system. You can find additional information about this setting in the section entitled . |
| The air intake is too weak. | <ul style="list-style-type: none"> Ensure that the grease filter is clean. To find out how to clean and replace the filter, refer to the section entitled → <i>"Cleaning and servicing", Page 25.</i> |

21.2 Noise

| Question | Answer |
|---|--|
| Why can I hear noises while I'm cooking? | <ul style="list-style-type: none"> Noises may be generated while using the hob depending on the base material of the cookware. These noises are normal for induction technology. They do not indicate that there is a fault. |
| What noises can occur and what is the significance of the noises? | <ul style="list-style-type: none"> A deep humming noise similar to a transformer: Occurs when cooking at a high power level. This noise disappears or becomes quieter when you reduce the power level. A quiet whistling noise: This can be heard when the cookware is empty. This noise disappears when you add water or food to the cookware. Crackling: This noise occurs when the cookware is made from different multilayer materials, or if you use cookware of different sizes and different materials. The loudness of the noise can vary depending on the quantity of food being cooked or the cooking method. Loud whistling noises: These may arise if you are operating two cooking zones at the same time and at the maximum power level. These whistling noises disappear or become quieter when you reduce the power level. Fan noises: The hob is equipped with a fan that switches on automatically at high temperatures. The fan may also continue to run after you have switched the hob off if the temperature measured is still too high. |

21.3 Cookware

| Question | Answer |
|--|--|
| Which cookware is suitable for the induction hob? | <ul style="list-style-type: none"> You can find more information on which items of cookware are compatible with induction cooking in → <i>"Induction cooking", Page 7.</i> |
| Why is the cooking zone not heating up and why is the heat setting flashing? | <ul style="list-style-type: none"> The cookware is on a different cooking zone to the one that has been switched on. Check that you have switched on the correct cooking zone. The cookware is too small for the cooking zone that is switched on or it is not suitable for induction cooking. Ensure that the cookware is suitable for induction cooking and that it is placed on the cooking zone which best corresponds to its size. You can find more information about this in → <i>"Induction cooking", Page 7</i> |
| Why is it taking so long for the cookware to heat up or why is it not heating up sufficiently despite being on a high power setting? | <ul style="list-style-type: none"> The cookware is too small for the cooking zone that is switched on or it is not suitable for induction cooking. Ensure that the cookware is suitable for induction cooking and that it is placed on the cooking zone which best corresponds to its size. You can find more information about this in → <i>"Induction cooking", Page 7</i> → <i>"Cookware", Page 7</i> |

21.4 Cleaning

| Question | Answer |
|--|--|
| How can I clean the hob? | <ul style="list-style-type: none"> You can achieve the best results by using special glass-ceramic cleaning products. Do not use harsh or abrasive cleaning products, dishwasher detergent (concentrated) or scouring pads. You can find more information about this under → "Cleaning and servicing", Page 25. |
| There is water in the cabinet underneath the hob. | <ul style="list-style-type: none"> Check whether the overflow container is full. You can find further information about cleaning and caring for the hob under → "Cleaning and servicing", Page 25. |
| How often do I need to clean the overflow container? | <ul style="list-style-type: none"> Clean the overflow container frequently. You can find further information about how to clean the overflow container under → "Cleaning and servicing", Page 25. |
| How often do I need to clean the grease filter? | <ul style="list-style-type: none"> Regularly clean the grease filter. To find out how to clean and replace the filter, refer to the section entitled → "Cleaning and servicing", Page 25. |

22 Troubleshooting

You can rectify minor faults on your appliance yourself. Read the troubleshooting information before contacting after-sales service. This will avoid unnecessary costs.

⚠ WARNING – Risk of injury!

Improper repairs are dangerous.

- ▶ Repairs to the appliance should only be carried out by trained specialist staff.
- ▶ If the appliance is defective, call Customer Service. → "Customer Service", Page 33

⚠ WARNING – Risk of electric shock!

Improper repairs are dangerous.

- ▶ Repairs to the appliance should only be carried out by trained specialist staff.
- ▶ Only use genuine spare parts when repairing the appliance.
- ▶ If the power cord or the appliance power cable of this appliance is damaged, it must be replaced with a special power cord or special appliance power cable, which is available from the manufacturer or its Customer Service.

22.1 Warnings

Notes

- If E appears in the displays, press and hold the sensor for the respective cooking zone and read the fault code.
- If the fault code is not listed in the table, disconnect the hob from the power supply and wait 30 seconds before reconnecting it. If this display appears again, contact the technical after-sales service and specify the exact fault code.
- If an error occurs, the appliance does not switch to standby mode.
- In order to protect the appliance's electronic parts from overheating or surge currents, the hob may temporarily reduce the power level.

22.2 Malfunctions

| Fault | Cause and troubleshooting |
|-------------------------------|---|
| The appliance is not working. | The mains plug of the power cord is not plugged in. <ul style="list-style-type: none"> ▶ Connect the appliance to the power supply. |
| | The circuit breaker in the fuse box has tripped. <ul style="list-style-type: none"> ▶ Check the circuit breaker in the fuse box. |
| | There has been a power cut. <ul style="list-style-type: none"> ▶ Check whether the lighting in your room or other appliances are working. |
| No display | The power supply has been disconnected. <ul style="list-style-type: none"> ▶ Use other electrical appliances to check whether a short circuit has occurred in the power supply. |
| | The appliance has not been connected in accordance with the circuit diagram. <ul style="list-style-type: none"> ▶ Ensure that the appliance has been connected in accordance with the circuit diagram. |

| Fault | Cause and troubleshooting |
|---|--|
| No display | Electronics fault. ▶ If the fault cannot be eliminated, inform after-sales service. |
| An audible signal sounds. | The control panel is damp or an object is covering it. ▶ Dry the control panel or remove the object. |
| The appliance has switched off the cooking zone. The illuminated ring on the control knob flashes. | The control knob has not been turned for a long time. The automatic safety cut-out function has been activated. 1. Turn the control knob to 0 . 2. Switch on the cooking zone again. <hr/> The appliance is too hot. ▶ Note the fault message on the control panel. |
| The displays flash. | The appliance does not detect the cookware. 1. Ensure that the cookware is suitable for induction cooking. → "Induction cooking", Page 7 2. Ensure that the diameter of the base of the cookware corresponds to the cooking zone. 3. Turn the control knob to 0 . 4. Switch on the cooking zone again. |
| The selected power level flashes. The illuminated ring on the control knob lights up orange. After approx. nine minutes, the appliance switches the cooking zone off. The illuminated ring on the control knob flashes. | The appliance does not detect the cookware or there is no cookware on the cooking zone. 1. Ensure that the cookware is suitable for induction cooking. → "Induction cooking", Page 7 2. Ensure that cookware is on the selected cooking zone. 3. Turn the control knob to 0 . 4. Switch on the cooking zone again. |
| F2 | The electronics have overheated and have switched off the corresponding cooking zone. 1. Remove the cooking utensils from the cooking zone. ✓ When the fault display goes out, the cooking zone has cooled down sufficiently. 2. Turn the control knob to 0 . 3. Set the heat setting as usual. |
| F4 | The electronics have overheated and all of the cooking zones have been switched off. 1. Remove the cooking utensils from the cooking zone. ✓ When the fault display goes out, the cooking zone has cooled down sufficiently. 2. Turn the control knob to 0 . 3. Set the heat setting as usual. |
| F5 + heat setting and signal tone | There is hot cookware near the control panel. There is a risk that the electronics will overheat. 1. Remove the cookware. 2. Wait a few seconds. ✓ The fault display goes out. 3. Continue cooking as usual. |
| F5+ audible signal | There is hot cookware near the control panel. To protect the electronics, the cooking zones have been switched off. 1. Remove the cookware. 2. Wait a few seconds. ✓ The fault display goes out. 3. Continue cooking as usual. |
| F1/F6 | The cooking zone has overheated and it has been switched off to protect the work surface. 1. Wait until the electronics have cooled sufficiently. 2. Switch on the cooking zone again. |
| F8 | The cooking zone has been operating continuously for an extended period. Automatic switch-off is activated. ▶ Observe the information on automatic switch-off → Page 20. |

| Fault | Cause and troubleshooting |
|---|---|
| <i>F9</i> | The FlexPlus cooking zone cannot be activated. <ol style="list-style-type: none"> 1. Check the fault display by pressing any control. 2. Continue to cook with the remaining cooking zones. 3. Contact the after-sales service. |
| <i>E9000 / E9010</i> | The operating voltage is incorrect, outside of the normal operating range. <ul style="list-style-type: none"> ▶ Contact the electricity supplier. |
| <i>U400</i> | The hob has not been connected correctly. <ol style="list-style-type: none"> 1. Disconnect the hob from the mains. 2. Ensure that the hob has been connected in accordance with the circuit diagram. |
| The illuminated ring colour does not match the illuminated ring colour of other appliances. | The illuminated ring colour is brighter or darker than the illuminated ring colour of other appliances. <ul style="list-style-type: none"> ▶ Change the illuminated ring colour in the basic settings → <i>Page 20</i>. |
| <i>dE07</i> lights up. The appliance does not heat up. | Demo mode is activated. <ul style="list-style-type: none"> ▶ Deactivate the demo mode. → <i>Page 32</i> |
| The touch fields for the ventilation functions do not light up. | The control for the motor does not work. <ul style="list-style-type: none"> ▶ Call → "<i>Customer Service</i>", <i>Page 33</i>. |
| The ventilation is not working. | The motor or the control are defective. <ul style="list-style-type: none"> ▶ Call → "<i>Customer Service</i>", <i>Page 33</i>. |
| The symbol lighting is not working. | The control unit is defective. <ul style="list-style-type: none"> ▶ Call → "<i>Customer Service</i>", <i>Page 33</i>. |
| ☉ lights up. | The odour filters are saturated. <ul style="list-style-type: none"> ▶ Replace the odour filter. → <i>Page 26</i> |
| ☉ lights up. | The saturation indicator lights up even though the odour filter has been replaced. <ul style="list-style-type: none"> ▶ Reset the saturation indicator. → <i>Page 27</i> |
| <i>F2/E8207/E7015</i> | The electronics have overheated and have switched off the corresponding cooking zone. <ol style="list-style-type: none"> 1. Wait until the electronics have cooled sufficiently. 2. Press any of the hob's touch fields. |
| <i>F4/E8208/E7015</i> | The electronics have overheated and all of the cooking zones have been switched off. <ol style="list-style-type: none"> 1. Wait until the electronics have cooled sufficiently. 2. Press any of the hob's touch fields. |
| Home Connect is not working properly. | Different causes are possible. <ul style="list-style-type: none"> ▶ Reset the saved connections to the home network and to Home Connect. ▶ Go to www.home-connect.com. |
| <i>E7010</i> | The hob is unable to connect to your home network. <ol style="list-style-type: none"> 1. Press any touch field to confirm the fault display. 2. Continue cooking as usual without connecting to the home network. |

22.3 Deactivating demo mode

The appliance does not heat up in demo mode. If *dE07* is lit up, demo mode is activated.

1. Disconnect the appliance from the mains power supply.
2. Wait 30 seconds.
3. Reconnect the appliance.
 - Deactivate the demo mode within the next three minutes.
4. Turn one of the control knobs anti-clockwise to >>>.
5. Turn the same control knob clockwise to **1**.
6. Turn the same control knob anti-clockwise to **0**.
 - ✓ The illuminated ring on the control knob lights up yellow.

7. Turn the same control knob clockwise to **1**.
 - ✓ **07** lights up.
 - ✓ The illuminated ring on the control knob lights up green.
8. Wait approx. five seconds.
 - ✓ **OFF** lights up.
 - ✓ The illuminated ring on the control knob lights up yellow.
 - ✓ The demo mode is deactivated.

22.4 Normal noises from your appliance

An induction hob may sometimes cause noises or vibrations, such as buzzing, crackling, hissing noises, fan noises or rhythmic noises.

23 Customer Service

Function-relevant genuine spare parts according to the corresponding Ecodesign Order can be obtained from Customer Service for a period of at least 10 years from the date on which your appliance was placed on the market within the European Economic Area.

Note: Under the terms of the manufacturer's warranty the use of Customer Service is free of charge.

Detailed information on the warranty period and terms of warranty in your country is available from our after-sales service, your retailer or on our website.

If you contact Customer Service, you will require the product number (E-Nr.) and the production number (FD) of your appliance.

The contact details for Customer Service can be found in the enclosed Customer Service directory or on our website.

23.1 Product number (E-Nr.) and production number (FD)

You can find the product number (E-Nr.) and the production number (FD) on the appliance's rating plate. The rating plate is located on the underside of the appliance.

The rating plate can be found:

- On the appliance certificate.
- On the underside of the hob, towards the front.

The product number (E no.) can also be found on the glass ceramic. You can also display the customer service index (KI) and the production number (FD) in the basic settings. → Page 20

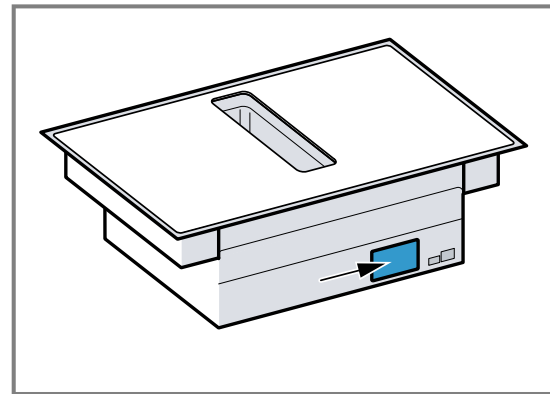

Make a note of your appliance's details and the Customer Service telephone number to find them again quickly.

24 Declaration of Conformity

BSH Hausgeräte GmbH hereby declares that the appliance with Home Connect functionality conforms to the basic requirements and other relevant provisions of Directive 2014/53/EU.

A detailed RED Declaration of Conformity can be found online at www.gaggenau.com among the additional documents on the product page for your appliance.



Hereby, BSH Hausgeräte GmbH declares that the appliance with Home Connect functionality is in compliance with relevant statutory requirements.¹

A detailed Declaration of Conformity can be found online at www.gaggenau.com/gb among the additional documents on the product page for your appliance.¹



2.4 GHz band (2400–2483.5 MHz): Max. 100 mW
5-GHz band (5150–5350 MHz + 5470–5725 MHz): max. 50 mW



| | | | | | | | | |
|----|----|----|----|----|---------|----|----|----|
| BE | BG | CZ | DK | DE | EE | IE | EL | ES |
| FR | HR | IT | CY | LI | LV | LT | LU | HU |
| MT | NL | AT | PL | PT | RO | SI | SK | FI |
| SE | NO | CH | TR | IS | UK (NI) | | | |

5 GHz WLAN (Wi-Fi): For indoor use only.

| | | | | | | | |
|----|----|----|----|----|----|----|----|
| AL | BA | MD | ME | MK | RS | UK | UA |
|----|----|----|----|----|----|----|----|

5 GHz WLAN (Wi-Fi): For indoor use only.

¹ Only applies to Great Britain

24.1 Statement of Compliance for Great Britain

Product type

This statement of compliance covers the products described in this information for use whose model identifier group is seen on the title page. The full model identifier is made up of the characters before the slash in the product number (E no.) which can be found on the rating plate. Alternatively, you can also find the model identifier in the first line of the UK Energy Label.

Name and address of manufacturer

BSH Hausgeräte GmbH, Carl-Wery-Strasse 34, 81739 München, Germany

This statement of compliance is prepared by the manufacturer.

The manufacturer, BSH Hausgeräte GmbH deems that it has complied with

- provision 5.1-1 of ETSI EN 303 645 v2.1.1 and, where relevant, provision 5.1-2 of ETSI EN 303 645 v2.1.1;
- provision 5.2-1 of ETSI EN 303 645 v2.1.1;
- provision 5.3-13 of ETSI EN 303 645 v2.1.1.

Support period

BSH Hausgeräte GmbH will provide security updates that are necessary to maintain the main functions free of charge until at least 28/02/2034.



A series of horizontal lines for writing, consisting of 30 lines in total, spaced evenly down the page.

BSH Hausgeräte GmbH
Carl-Wery-Straße 34
81739 München, GERMANY
www.gaggenau.com

Valid within Great Britain:
Imported to Great Britain by
BSH Home Appliances Ltd.
Grand Union House
Old Wolverton Road
Wolverton, Milton Keynes
MK12 5PT
United Kingdom

GAGGENAU



9001603292 en (040424)