

Gaggenau

en User manual and installation instructions

BSP2201.1, BSP2211.1

Steamer

Table of contents

INFORMATION FOR USE

1	Safety	2
2	Preventing material damage	4
3	Environmental protection and saving energy	5
4	Familiarising yourself with your appliance	6
5	Accessories	9
6	Before using for the first time	10
7	Basic operation	11
8	Timer functions	12
9	Childproof lock	14
10	Home Connect	14
11	Basic settings	16
12	Cleaning and servicing	18
13	Troubleshooting	21
14	Disposal	24
15	How it works	24
16	Customer Service	39
17	Declaration of Conformity	40
18	INSTALLATION INSTRUCTIONS	40
18.1	General installation instructions	40

1 Safety

Observe the following safety instructions.

1.1 General information

- Read this instruction manual carefully.
- Keep the instruction manual and the product information safe for future reference or for the next owner.
- Do not connect the appliance if it has been damaged in transit.

1.2 Intended use

This appliance is designed only to be built into kitchen units. Read the special installation instructions.

Only a licensed professional may connect appliances without plugs. Damage caused by incorrect connection is not covered under the warranty.

Only use this appliance:

- To prepare meals and drinks.
- in private households and in enclosed spaces in a domestic environment.
- up to an altitude of max. 4000 m above sea level.

1.3 Restriction on user group

This appliance may be used by children aged 8 or over and by people who have reduced physical, sensory or mental abilities or inadequate experience and/or knowledge, provided that they are supervised or have been instructed on how to use the appliance safely and have understood the resulting dangers.

Do not let children play with the appliance.

Children must not perform cleaning or user maintenance unless they are at least 15 years old and are being supervised.

Keep children under the age of 8 years away from the appliance and power cable.

1.4 Safe use

Follow these instructions when using a steam function.

WARNING – Risk of burns!

The appliance and its parts that can be touched become hot during use.

- ▶ Caution should be exercised here in order to avoid touching heating elements.
- ▶ Young children under 8 years of age must be kept away from the appliance.
- ▶ Never touch the ventilation openings.

Accessories and cookware get very hot.

- ▶ Always use oven gloves to remove accessories or cookware from the cooking compartment.

WARNING – Risk of scalding!

The accessible parts of the appliance become hot during operation.

- ▶ Never touch these hot parts.
- ▶ Keep children at a safe distance.

Hot steam may escape when you open the appliance door. Steam may not be visible, depending on the temperature.

- ▶ When opening the door, do not stand too close to the appliance.
- ▶ Open the appliance door carefully.
- ▶ Keep children at a safe distance.

If there is water in the cooking compartment when it is hot, this may create hot steam.

- ▶ Never pour water into the cooking compartment when the cooking compartment is hot.

Hot liquid may spill over the sides of the accessory when it is removed from the cooking compartment.

- ▶ Remove hot accessories with care and always wear oven gloves.

⚠ WARNING – Risk of injury!

Scratched glass in the appliance door may develop into a crack.

- ▶ Do not use any harsh or abrasive cleaners or sharp metal scrapers to clean the glass on the oven door, as they may scratch the surface.

The light emitted by LED lights is very dazzling, and can damage the eyes (risk group 1).

- ▶ Do not look directly into the switched on LED lights for longer than 100 seconds.

⚠ WARNING – Risk of fire!

Due to the hot surfaces, vapours from flammable liquids may catch fire in the cooking compartment (explosion). The appliance door may spring open. Hot steam and jets of flame may escape.

- ▶ Do not pour flammable liquids (e.g. alcoholic drinks) into the water tank.
- ▶ Only fill the water tank with water or with the descaling solution we have recommended.

⚠ WARNING – Risk of electric shock!

Improper repairs are dangerous.

- ▶ Repairs to the appliance should only be carried out by trained specialist staff.
- ▶ Only use genuine spare parts when repairing the appliance.

If the insulation of the power cord is damaged, this is dangerous.

- ▶ Never let the power cord come into contact with hot appliance parts or heat sources.
- ▶ Never let the power cord come into contact with sharp points or edges.
- ▶ Never kink, crush or modify the power cord.

An ingress of moisture can cause an electric shock.

- ▶ Do not use steam- or high-pressure cleaners to clean the appliance.

If the appliance or the power cord is damaged, this is dangerous.

- ▶ Never operate a damaged appliance.
- ▶ Never pull on the power cord to unplug the appliance. Always unplug the appliance at the mains.
- ▶ If the appliance or the power cord is damaged, immediately unplug the power cord or switch off the fuse in the fuse box.
- ▶ Call customer services. → *Page 39*

⚠ WARNING – Risk of suffocation!

Children may put packaging material over their heads or wrap themselves up in it and suffocate.

- ▶ Keep packaging material away from children.
- ▶ Do not let children play with packaging material.

Children may breathe in or swallow small parts, causing them to suffocate.

- ▶ Keep small parts away from children.
- ▶ Do not let children play with small parts.

1.5 Cleaning

Follow these safety instructions when cleaning the appliance.

⚠ WARNING – Risk of scalding!

The descaling tablets may cause chemical burns in the mouth, throat, eyes and on the skin.

- ▶ Follow the safety instructions on the packaging of the descaling tablets.
- ▶ Avoid the skin coming into contact with the descaling tablets.
- ▶ Keep children away from the descaling tablets.

The descaling solution may cause chemical burns in the mouth, throat and eyes or on the skin.

- ▶ Avoid the skin coming into contact with the descaling solution.
- ▶ Keep children away from the descaling solution.

- ▶ Do not drink the descaling solution.
- ▶ The descaling solution must not come into contact with food.
- ▶ Clean the water tank in the dishwasher or thoroughly by hand before you next use the appliance.

2 Preventing material damage

2.1 General

ATTENTION!

A build-up of heat may damage the appliance.

- ▶ Do not place anything directly on the cooking compartment floor.
- ▶ Do not line the cooking compartment floor with aluminium foil.
- ▶ Always place cookware in a perforated cooking container or on a wire rack.

Using unsuitable liquids may damage the appliance.

- ▶ Do not use any liquids other than water.
- ▶ Only use cold, fresh tap water, softened water or non-carbonated mineral water.

Chloride and acids may damage the stainless steel surface.

- ▶ Remove any residues of salt, hot sauces, e.g. ketchup or mustard, salted food, e.g. salted roasts, or other foods containing chloride or acid immediately.

Aluminium foil can cause permanent discolouration on the door pane.

- ▶ Ensure that the aluminium foil does not come into contact with the door pane.

Fruit juice can cause permanent stains in the cooking compartment.

- ▶ Always remove fruit juice immediately.
- ▶ Wipe with a damp cloth, followed by a dry cloth.

The prolonged presence of moisture in the cooking compartment leads to corrosion.

- ▶ Do not keep moist food in the cooking compartment for a long time with the door closed.
- ▶ Do not store food in the cooking compartment.

Rusting material may lead to corrosion in the cooking compartment.

- ▶ Only use original accessories in the cooking compartment.
- ▶ Do not use any enamelled baking trays or grill trays.
- ▶ Never use serving plates or cutlery that may rust.

Small parts that are not original may damage the appliance.

- ▶ Only use original small parts, e.g. knurled nuts.
- ▶ If necessary, order small parts from our spare parts service.

Heat can damage stainless steel cooking containers.

- ▶ Only heat stainless steel cooking containers up to 230 °C.
- ▶ Do not use stainless steel cooking containers in the oven.

Leaving the appliance to cool down with the door open will damage the front of adjacent units over time.

- ▶ Always allow the cooking compartment to cool down with the door closed after cooking at high temperatures.
- ▶ Take care not to trap anything in the appliance door.

If the seal is very dirty, the appliance door will no longer close properly during operation. This may damage the front of adjacent kitchen units.

- ▶ Keep the seal clean at all times.
- ▶ Never operate the appliance if the seal is damaged or missing.

Sitting or placing objects on the appliance door may damage it.

- ▶ Do not place, hang or support objects on the appliance door.
- ▶ Do not place cookware or accessories on the appliance door.

Carrying the appliance by the door handle could break it. The door handle cannot support the weight of the appliance.

- ▶ Do not carry or hold the appliance by the door handle.

2.2 Steam

ATTENTION!

Dripping liquids may damage the cooking compartment.

- ▶ To catch any dripping liquids, when steaming using a perforated cooking container, always insert the unperforated cooking container underneath.

Using cookware with rust spots may cause corrosion in the cooking compartment. Even the smallest spots of rust can cause corrosion.

- ▶ Do not use cookware with rust spots.

Hot water in the water tank may damage the steam system.

- ▶ Only fill the water tank with cold water.

If descaling solution comes into contact with the control panel or other delicate surfaces, it will damage them.

- ▶ Remove descaling solution immediately with water.

2.3 Cleaning

ATTENTION!

Limescale may damage the appliance.

- ▶ Descale the appliance regularly.

Using the wrong descaler may damage the appliance.

- ▶ Only use the specified descaling tablets.

Improper care of the appliance can lead to corrosion in the cooking compartment.

- ▶ Follow the care and cleaning instructions for the appliance.
→ *"Cleaning and servicing", Page 18*
- ▶ Clean the cooking compartment each time you use it as soon as the appliance has cooled down.
- ▶ Dry the cooking compartment after cleaning.

The descaling tablet may damage the cooking compartment.

- ▶ Use the descaling tablet for the descaling programme only.
- ▶ Place the descaling tablet into the water tank.
- ▶ Never place the descaling tablet in the cooking compartment or heat it up in the cooking compartment.

Heat damages the water tank.

- ▶ Do not dry the water tank in the hot cooking compartment.

3 Environmental protection and saving energy

3.1 Disposing of packaging

The packaging materials are environmentally compatible and can be recycled.

- ▶ Sort the individual components by type and dispose of them separately.

3.2 Saving energy

If you follow these instructions, your appliance will use less power.

When steaming, you can cook on several levels at the same time.

- With steam, various dishes can be prepared at the same time without the different flavours mixing.
When preparing dishes with different cooking times, those with the longest cooking time should be placed in the oven first.

When cooking multiple dishes, do so in succession or in parallel.

- The cooking compartment is heated after cooking the first dish. This reduces the cooking time for the following dishes.

If the cooking time is relatively long, you can switch the appliance off 10 minutes before the cooking time ends.

- There will be enough residual heat to finish cooking the dish.

Open the appliance door as little as possible during operation.

- This maintains the temperature in the cooking compartment and eliminates the need for the appliance to reheat.

Remove any accessories that are not being used from the cooking compartment.

- Accessories that are not being used do not need to be heated.

Allow frozen food to defrost before cooking.

- This saves the energy that would otherwise be required to defrost it.

4 Familiarising yourself with your appliance

4.1 Appliance

You can find an overview of the parts of your appliance here.

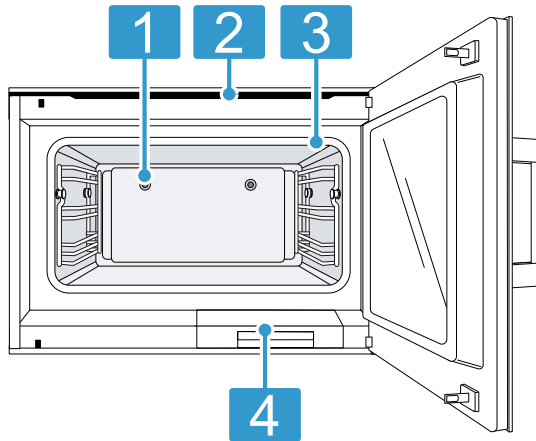

1	Steam outlet
2	Ventilation slots
3	Door seal
4	Water tank

Cooking compartment

The cooking compartment has three shelf levels. Count the shelf levels from the bottom up.

ATTENTION!

A build-up of heat may damage the appliance.

- ▶ Ensure that the cooking compartment floor always remains clear.
- ▶ Do not place anything directly on the cooking compartment floor.
- ▶ Do not line the cooking compartment floor with aluminium foil.
- ▶ Always place cookware in the perforated cooking container or on the wire rack.

The accessories may tip.

- ▶ Do not push the accessories between the shelf positions.

The bottom shelf level has two shelf positions. This means that, when defrosting, for example, you can slide the unperforated cooking container in below the perforated cooking container in order to collect excess liquid.

You can use up to three shelf levels at the same time.

Always open the appliance door as far as it will go. In this position, the open appliance door does not swing back.

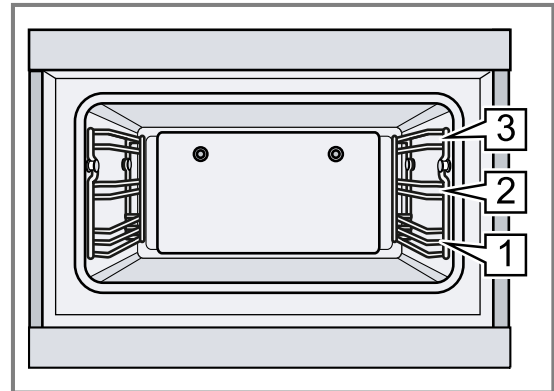

Controls

You can use the control panel to configure all functions of your appliance and to obtain information about the operating status.

On certain models, specific details such as colour and shape may differ from those pictured. All appliance types are operated in an identical manner.

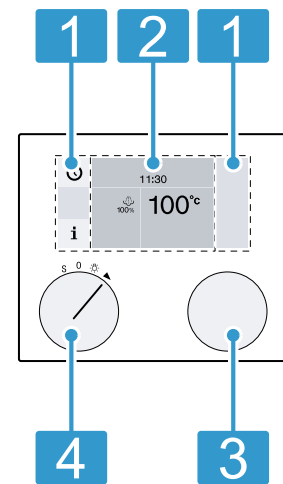

1	Touch fields	These areas are touch-sensitive. Touch a symbol to select the corresponding function.
2	Display	The display shows current settings and selection options, for example.
3	Rotary selector	Use the rotary selector to select the temperature and change additional settings.
4	Function selector	Use the function selector to select the type of heating, cleaning or the basic settings.

Symbols

Use the symbols to start or stop functions, or to navigate in the menu.

Symbol	Function
▶	Start
■	Stop
	Pause or end
X	Cancel
C	Delete
✓	Confirm or save settings
>	Selection arrow
i	Call up additional information
>>	Rapid heating with status display
↘	Edit settings
🔒	Childproof lock
🕒	Call up the timer menu
🔧	Demo mode
📶	Network connection (Home Connect)

Colours

The different colours are used to guide the user in the relevant setting situations.

Orange	<ul style="list-style-type: none"> ■ Initial settings ■ Main functions
--------	--

Position of the function selector

Use the function selector to select the functions or types of heating.

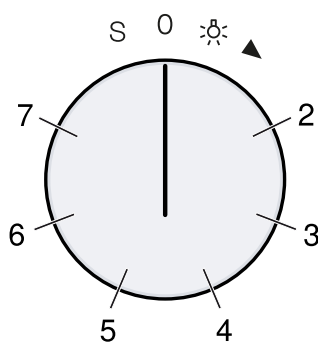









Blue	<ul style="list-style-type: none"> ■ Basic settings ■ Cleaning
White	Adjustable values

Appearance

Depending on the situation, the appearance of symbols, values or the entire display changes.

Zoom	The appliance zooms in on the setting that you have just changed. If you have set a time and it is about to run out, it will appear larger on the display just before it runs out, e.g. if you have set the timer.
Pared-down display	After a short while, the appliance reduces the amount of information shown on the display and only the most important information remains. This function is preset. You can change the setting in the basic settings.

Position	Function/type of heating	Temperature	Application
0	Zero setting		
☀	Light		Switching on the interior lighting
2	 Hot air + 100% humidity	30-100 °C Default temperature 100 °C	Steaming at 70 °C to 100 °C: For vegetables, fish and side dishes The food is completely enveloped by steam.
3	 Sous-vide cooking	50-95 °C Default temperature 60 °C	Cooking food in a vacuum at low temperatures between 50-95 °C and with 100% steam: Suitable for meat, fish, vegetables and desserts A vacuum-sealing machine uses heat to hermetically seal the food in a special heat-resistant cooking bag. The protective envelope retains the nutrients and flavours.

Position	Function/type of heating	Temperature	Application
4	 Dough proving	30-50 °C Default temperature 38 °C	Proving: For yeast dough and sour dough The dough rises considerably more quickly than at room temperature. Hot air and steam are combined so that the surface of the dough does not dry out. The optimal temperature setting for yeast dough is 38 °C.
5	 Defrosting	40-60 °C Default temperature 45 °C	For vegetables, meat, fish and fruit The appliance uses the moisture to gently transfer the heat to the food. The food does not dry out or lose its shape.
6	 Reheating	60-100 °C Default temperature 100 °C	For cooked food and baked goods For gently reheating cooked food. The steam ensures that the food does not dry out.
7	 Low-temperature steaming	70-90 °C Default temperature 70 °C	Low-temperature cooking for meat Gentle slow cooking for a particularly tender result
S	 Basic settings		Adapt the appliance to individual requirements in the basic settings → <i>Page 16</i>
S	 Cleaning aid		Use the cleaning aid → <i>Page 20</i> to remove stubborn dirt in the cooking compartment with steam
S	 Descaling programme		Use the descaling programme → <i>Page 20</i> to remove limescale from the appliance

4.2 Standby

The appliance switches to standby mode if no function is set or the childproof lock is activated. The standby screen appears if you do not implement any settings for a long time.

Different displays can be shown in standby mode. The GAGGENAU logo and the time are preset.

In standby mode, the brightness of the control panel is reduced. The brightness of the display depends on the vertical viewing angle. You can change the display and the brightness at any time in the basic settings → *Page 16*.

When "Off" is selected for the standby display in the basic settings, you must turn the function selector to exit standby mode.

When the door is open, the interior lighting switches off after a short time.



4.3 Additional information

Press **i** to display additional information, e.g. information about the type of heating that is set or the current cooking compartment temperature.

During continuous operation after heating up, slight temperature fluctuations are normal.

The appliance displays the **i** symbol for important information and indicates that an action is required. The appliance also occasionally displays important informa-

tion about safety and the operating status automatically. These messages disappear automatically after a few seconds, or press ✓ to confirm the message. For messages about Home Connect, the appliance also displays the Home Connect status in the **i**[®] symbol.

→ "Home Connect ", Page 14

4.4 Cooling fan

The cooling fan switches on when the appliance is in operation. The hot air escapes above the door. After removing your food from the appliance, keep the door closed until the appliance has cooled down. The appliance door must not be left half open as this may damage adjacent kitchen units. The cooling fan continues running for a certain period of time after the appliance has stopped heating and then it switches itself off automatically. Do not cover the ventilation slots. Otherwise, the appliance will overheat.

4.5 Fan run-on

After operation, the cooking compartment is damp. The fan run-on removes moisture from the appliance and protects the appliance electronics. The cooling fan continues running after the appliance is switched off. The appliance switches the cooling fan off automatically. This may take up to 4 hours depending on the operating mode and temperature that are used. When the appliance has switched off the cooling fan, remove any remaining residual water from the cooking compartment floor and dry the cooking compartment with a soft cloth.

4.6 Safety switch-off function

For your safety, the appliance has a safety switch-off function. The appliance switches off any heating process after 12 hours if the appliance controls are not used during this time. The display shows a message.

5 Accessories

Use original accessories. These have been made especially for your appliance.

Note: Accessories may become deformed if they get hot. Deformation has no effect on function. As the accessory cools down, it will regain its original shape.

The accessories supplied may differ depending on the appliance model.

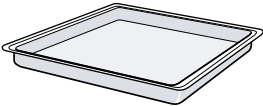
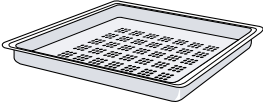
Accessories		Use
Wire rack		<ul style="list-style-type: none"> ■ Cookware ■ Cake tins ■ Ovenproof dishes ■ Frying
Stainless steel cooking container, unperforated		<ul style="list-style-type: none"> ■ Cooking rice ■ Cooking pulses ■ Cooking cereals ■ Baking tray bakes ■ Catching dripping liquid during steaming
Stainless steel cooking container, perforated		<ul style="list-style-type: none"> ■ Steaming vegetables ■ Steaming fish ■ Extracting juice from berries ■ Defrosting

5.1 Other accessories

You can purchase other accessories from our after-sales service, specialist retailers or online. You will find a comprehensive range of products for your appliance in our brochures and online: www.gaggenau.com Accessories vary from one appliance to another. When purchasing accessories, always quote the exact product number (E no.) of your appliance. You can find out which accessories are available for your appliance in our online shop or from our after-sales service.

Other accessories	Order number
Stainless steel cooking container, unperforated, 40 mm deep, 5 l	BA220360
Stainless steel cooking container, perforated, 40 mm deep, 5 l	BA220370
Cooking container, non-stick, unperforated	BA02038.
Cooking container, non-stick	BA020390
Set with 4 descaling tablets	17002490

en Before using for the first time

Other accessories	Order number
GN adapter, for use with GN cooking inserts and roasters	GN010330
Stainless steel cooking container, GN 1/3, unperforated, 40 mm deep, 1.5 l	GN114130
Stainless steel cooking container, GN 2/3, unperforated, 40 mm deep, 3 l	GN114230
Stainless steel cooking container, GN 1/3, perforated, 40 mm deep, 1.5 l	GN124130
Stainless steel cooking container, GN 2/3, perforated, 40 mm deep, 3 l	GN124230

5.2 Locking function

The locking function prevents the accessories from tilting when they are pulled out. You can pull out the accessories approximately halfway without them tipping. The accessories must be inserted into the cooking compartment correctly for the tilt protection to work correctly.

5.3 Sliding accessories into the cooking compartment

The wire rack and the perforated cooking container are fitted with a locking function. For the tilt protection to work correctly, always insert the wire rack and the perforated cooking container into the cooking compartment the right way round.

ATTENTION!

The accessories may tip.

- ▶ Do not push the accessories between the shelf positions.

1. When inserting the wire rack, ensure that the lug  is at the rear and is facing downwards.

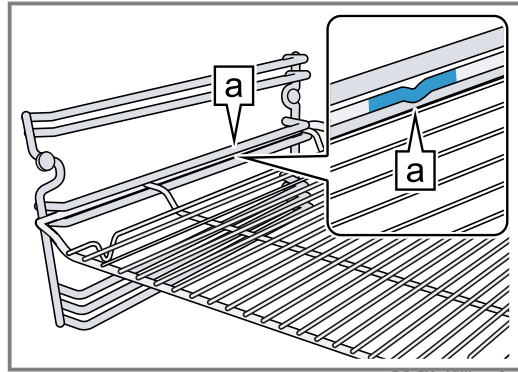

2. Ensure that the safety bracket on the wire rack is located at the rear and is facing upwards.
3. When inserting the perforated cooking container, ensure that the lug  is at the rear.

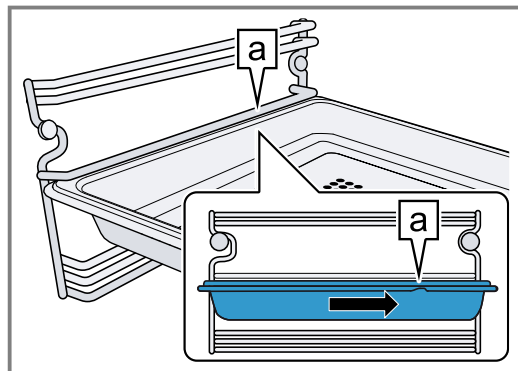

- ✓ The tilt protection is working.

Note: To pull out the accessories, lift them slightly. Remove any accessories that you do not require from the cooking compartment.

6 Before using for the first time

Configure the settings for initial start-up. Clean the appliance and accessories.

6.1 Initial use

Implement the settings for initial use before using your appliance.

First read the information under safety → Page 2.

The appliance must be installed and connected.

After connecting the appliance to the power supply, the GAGGENAU logo appears for approx. 30 seconds and then the appliance displays the "Initial settings" menu.

You can configure your new appliance for initial use.

The "Initial settings" menu appears only after the appliance has been connected to a power supply and switched on for the first time, or if the appliance has not been connected to a power supply for a number of days.

You can change all of the settings in the basic settings → Page 16.

Setting the language

Requirement: The display shows the preset language.

1. Use the rotary selector to select the required display language.
2. Press ✓ to confirm.

Setting the time format

Requirement: The display shows the possible formats 24h and AM/PM. 24h is preset.

1. Use the rotary selector to set the required format.
2. Press ✓ to confirm.

Set the time

Requirement: The display shows the time.

1. Use the rotary selector to set the required time.
2. Press ✓ to confirm.

Setting the date format

Requirement: The display shows the possible formats D.M.Y, D/M/Y and M/D/Y. D.M.Y is preset.

1. Use the rotary selector to set the required format.
2. Press ✓ to confirm.

Setting the date

Requirement: The display shows the preset date. The daily setting is already active.

1. Use the rotary selector to set the required day.
2. Press > to switch to the month setting.
3. Use the rotary selector to set the month.
4. Press > to switch to the year setting.
5. Turn the rotary selector to set the year.
6. Press ✓ to confirm.

Setting the temperature unit

Requirement: The display shows the possible units °C and °F. The unit °C is preset.

1. Turn the rotary selector to set the required unit.
2. Press ✓ to confirm.

Ending the initial use

Requirement: The display shows "Initial set-up complete".

- ▶ Press ✓.
- ✓ The appliance switches to standby mode.
- ✓ The display shows the standby screen.
- ✓ The appliance is ready to use.

Cleaning the door pane

Note: To ensure tightness, the door seal is lubricated at the factory. Residue may remain on the door pane.

- ▶ Before using for the first time, clean the door pane with glass cleaner and a window cloth or a microfibre cloth.
- Do not use a glass scraper.

Cleaning accessories

- ▶ Before first use, clean the accessories thoroughly using hot soapy water and a soft cloth.

7 Basic operation

7.1 Activating the appliance

1. To exit standby mode, open the door and turn the function selector or touch a touch field.
2. Set the required function.

7.2 Opening the appliance door

- ▶ Always open the appliance door as far as it will go. In this position the appliance door does not swing back.

7.3 Fill the water tank

⚠ WARNING – Risk of fire!

Due to the hot surfaces, vapours from flammable liquids may catch fire in the cooking compartment and cause an explosion. The appliance door may spring open. Hot steam and jets of flame may escape.

- ▶ Only fill the water tank with water or with the descaling solution that is recommended by us.

⚠ WARNING – Risk of burns!

The front edge of the cooking compartment becomes very hot during operation.

- ▶ When removing the water tank, only touch its handle.

ATTENTION!

The use of unsuitable liquids may damage the appliance.

- ▶ Only use fresh tap water, softened water or uncarbonated mineral water.
- ▶ If the tap water is very hard, we recommend using softened water.
- ▶ Do not use distilled water, highly chlorinated tap water (above 40 mg/l) or other liquids.

1. Before using the appliance, always fill the water tank.
2. Open the appliance door.

3. Pull the water tank out of the appliance until the fill level indicator is visible, or completely remove the water tank from the appliance.

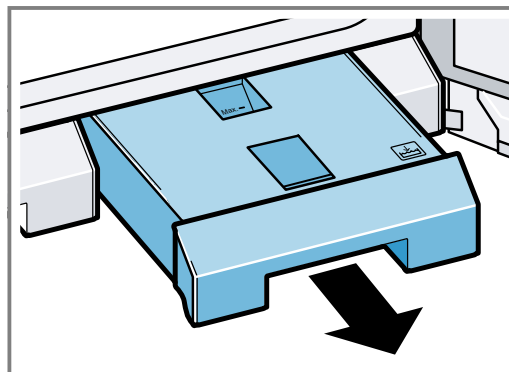

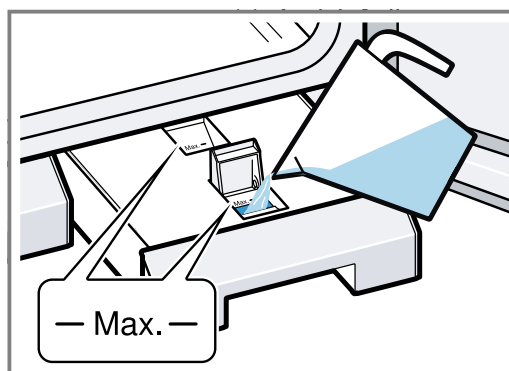

4. Open the valve on the water tank.
5. Fill the water tank with cold water up to the "Max." mark.



6. Close the flap on the water tank.
7. Slide the water tank back in as far as it will go.
8. If you use the appliance multiple times back to back, empty the remaining water from the water tank after each use and refill it with fresh water.

7.4 Switching on the appliance

- Use the function selector to set the required type of heating.
 - ✓ The display shows the selected type of heating and the suggested temperature.
- If required, use the rotary selector to set the desired temperature.
 - ✓ The display shows the heating symbol .
 - ✓ The bar displays the current heating status.
 - ✓ Once the appliance reaches the set temperature, a signal tone sounds and the heating symbol goes out .
- Refill the water tank if necessary.
 - "Fill the water tank", Page 11
 - During operation, the water tank is locked in the appliance. Only if the appliance shows that the water tank is empty can you remove the water tank.

7.5 Switching off the appliance

- ▶ Turn the function selector to 0. Depending on the type of heating, you may hear an automatic rinse cycle running.

7.6 After each use

After using the steam type of heating, dry the cooking compartment to ensure that no moisture remains in the appliance and to prevent odour from building up.

WARNING – Risk of scalding!

Hot steam may escape when you open the appliance door. Steam may not be visible, depending on the temperature.

- ▶ When opening the door, do not stand too close to the appliance.
- ▶ Open the appliance door carefully.
- ▶ Keep children at a safe distance.

Emptying the water tank

ATTENTION!

Heat damages the water tank.

- ▶ Do not dry the water tank in the hot cooking compartment.
- Open the appliance door carefully. Hot steam escapes.
 - Remove and empty the water tank.

Drying the cooking compartment

- Remove food residues and/or dirt from the cooking compartment as soon as the appliance has cooled down. Burnt-on food residue and/or dirt will be much harder to remove later.
- Use a sponge to wipe away any residual water from the cooking compartment once it has cooled down.
- Wipe out and polish the cooking compartment with a soft cloth.
- If necessary, wipe dry any condensation on units or handles.

7.7 Switching on the appliance after a safety switch-off

Requirement: After prolonged operation, the safety switch-off function → Page 9 switches off the appliance.





- Turn the function selector to 0.
- Switch the appliance back on again.

8 Timer functions

Your appliance has different timer functions, with which you can control its operation.

8.1 Overview of the timer functions

Use  to select the different timer functions.

Timer function	Use
	Short-term timer
	Cooking time ¹
	Cooking time end ¹
	Stopwatch

¹ Not available in standby mode.

8.2 Calling up the timer menu

Note: You can call up the timer menu from any operating mode. The timer menu is not available if you turn the function selector to S in the basic settings.

- ▶ Press .
- ✓ The display shows the timer menu.

8.3 Exiting the timer menu





- ▶ Press **X**.
- ✓ The timer menu is closed.
- ✓ Any settings that are not saved are lost.

Note: You can exit the timer menu at any time.

8.4 Short-term timer

The short-term timer runs independently of the other appliance settings. You can enter a maximum of 90 minutes.

Setting the short-term timer

- Press .
 - ✓ The display shows the "Short-term timer"  function.
- Use the rotary selector to set the required cooking time.
- Press  to start.
 - ✓ The appliance closes the timer menu.
 - ✓ The time counts down.
 - ✓ The display shows  and the time that has elapsed.
 - ✓ A signal tone sounds once the time has elapsed.

4. Press ✓.
- ✓ The signal tone stops.

Stopping the short-term timer

1. Press ○.
- ✓ The display shows the "Short-term timer" ⌘ function.
2. Press II.
- ✓ The short-term timer stops.
- ✓ The display shows ▶.
3. To allow the timer to continue counting down, touch ▶.

Switching off the timer early

1. Press ○.
- ✓ The display shows the "Short-term timer" ⌘ function.
2. Press C.

8.5 Stopwatch

The stopwatch runs independently of the other appliance settings. The stopwatch counts from 0 seconds up to 90 minutes.

The stopwatch has a pause function. This allows you to stop the stopwatch from time to time.

Starting the stopwatch

1. Press ○.
2. Use > to select the "Stopwatch" ⌚ function.
3. Press ▶ to start.
- ✓ The appliance closes the timer menu.
- ✓ The time counts down.
- ✓ The display shows ⌚ and the time that has elapsed.

Stopping the stopwatch

1. Press ○.
2. Use > to select the "Stopwatch" ⌚ function.
3. Press II.
- ✓ The time stops.
- ✓ The display shows ▶.
4. To continue to run the stopwatch, press ▶.
- ✓ The time continues to run.
- ✓ Once it has reached 90 minutes, the display flashes and a signal tone sounds.
5. Press ✓.
- ✓ The signal tone stops.

Switching off the stopwatch

1. Press ○.
2. Use > to select the "Stopwatch" ⌚ function.
3. Press C.

8.6 Cooking time

When you set the cooking time for your food, the appliance automatically switches off after this time. You can set a cooking time of between 1 minute and 23:59 hours.

You can change the type of heating and temperature while the cooking time counts down.

Setting the cooking time

Requirements

- The food is in the cooking compartment.
- You have set the type of heating and the temperature.

1. Press ○.
2. Use > to select the "Cooking time" ⌚ function.
3. Use the rotary selector to set the required cooking time.
4. Press ▶ to start.
- ✓ The appliance starts the cooking time.
- ✓ The appliance closes the timer menu.
- ✓ The display shows the temperature, the operating mode, the remaining cooking time and the cooking time end.
- ✓ One minute before the end of the cooking time, the display zooms in on the cooking time.
- ✓ Once the cooking time has elapsed, the appliance switches off.
- ✓ ⌚ flashes and a signal tone sounds.
5. Press ✓, open the appliance door or set the function selector to 0.
- ✓ The signal tone stops.

Changing the cooking time

1. Press ○.
2. Use > to select the "Cooking time" ⌚ function.
3. Use the rotary selector to change the cooking time.
4. Press ▶ to start.

Deleting the cooking time

1. Press ○.
2. Use > to select the "Cooking time" ⌚ function.
3. Use C to cancel the cooking time.
4. Use X to return to normal operation.

Cancelling the entire procedure

- ▶ Turn the function selector to 0.

8.7 Cooking time end

You can move the cooking time end to a later time. Example: It is 14:00. The dish requires a cooking time of 40 minutes. You want the meal to be ready at 15:30. Enter the cooking time of 40 minutes and delay the cooking-time end until 15:30. The electronics system calculates the start time. The appliance starts automatically at 14:50 and switches off at 15:30. Bear in mind that food which spoils easily should not be left in the appliance for too long.

Delaying the cooking time end

Requirements

- The food is in the cooking compartment.
 - You have set the type of heating, temperature and cooking time.
1. Press ○.
 2. Use > to select the "Cooking time end" ⌚ function.
 3. Use the rotary selector to set the required cooking time end.
 - If ⌚ flashes, set the cooking time first.
 4. Press ▶ to start.
 - ✓ The appliance switches to standby.
 - ✓ The display shows the operating mode, temperature, cooking time and cooking time end.
 - ✓ The appliance starts at the calculated time and automatically switches off once the cooking time has elapsed.
 - ✓ After the cooking time has elapsed, ⌚ flashes and a signal tone sounds.

5. Press ✓, open the appliance door or set the function selector to 0.
✓ The signal tone stops.

Changing the cooking time end

1. Press 0.

2. Use > to select the "Cooking time end" 0 function.
3. Use the rotary selector to set the required cooking-time end.
4. Press ▶ to start.

Cancelling the entire procedure

- ▶ Turn the function selector to 0.

9 Childproof lock



Activate the childproof lock so that children cannot accidentally switch the appliance on or change the settings.

If the childproof lock is switched on and the power fails, the childproof lock can be deactivated when the power comes back on.

9.1 Activating the childproof lock

Requirements

- You can set the childproof lock to "available" in the basic settings → *Page 16*.
- The function selector is set to 0.

- ▶ Press and hold  for approx. 6 seconds.
- ✓ The display shows the standby screen and .
- ✓ The childproof lock is activated.

9.2 Deactivating the childproof lock

Requirement: The function selector is set to 0.

1. Press and hold  for approx. 6 seconds.
✓ The childproof lock is deactivated.
2. Set the appliance as normal.

10 Home Connect

This appliance is network-capable. Connecting your appliance to a mobile device lets you control its functions via the Home Connect app, adjust its basic settings and monitor its operating status.

The Home Connect services are not available in every country. The availability of the Home Connect function depends on the availability of Home Connect services in your country. You can find information about this at: www.home-connect.com.

The Home Connect app guides you through the entire login process. Follow the instructions in the Home Connect app to configure the settings.

Tip: Please also follow the instructions in the Home Connect app.

Notes

- Please note the safety precautions in this instruction manual and make sure that they are also observed when operating the appliance via the Home Connect app.
→ *"Safety", Page 2*
- Operating the appliance on the appliance itself always takes priority. During this time it is not possible to operate the appliance using the Home Connect app.
- In networked standby mode, the appliance requires a maximum of 2 W.
- If you want to operate the appliance via the Home Connect app, you must activate the remote control function in the Home Connect settings first. This function is for your own safety. Turn the function selector on the appliance to the light position  to enable the remote control function.

10.1 Setting up the Home Connect app

1. Install the Home Connect app on your mobile device.
2. Start the Home Connect app and set up access for Home Connect.
The Home Connect app guides you through the entire login process.

10.2 Setting up Home Connect

Requirements











- The appliance is connected to the power supply and is switched on.
 - You have a mobile device with a current version of the iOS or Android operating system, e.g. a smartphone.
 - The Home Connect app has been installed on your mobile device.
 - The appliance is receiving signals from the WLAN home network (Wi-Fi) at its installation location.
 - The mobile device and the appliance are within range of your home network's Wi-Fi signal.
1. Open the Home Connect app and scan the following QR code.



2. Follow the instructions in the Home Connect app.

10.3 Home Connect settings

You can adjust the Home Connect settings and network settings in your appliance's basic settings. Which settings the display shows will depend on whether Home Connect has been set up and whether the appliance is connected to your home network.

Symbol	Basic setting	Possible settings	Explanation
	Connection type	LAN Wi-Fi	You can switch between connection types (LAN cable and Wi-Fi). Follow the instructions for setting up the relevant connection type.
	Connection	Connect Disconnect	You can switch the network connection on or off as required. The network information is retained after the appliance is switched off. After switching on the appliance, wait for a few seconds until it reconnects to the network. Note: In networked standby mode, the appliance requires a maximum of 2 W.
	Connect to app		Start the connection process between the app and the appliance.
	Software update		As soon as a new software version is available, a message appears on the display. In the Home Connect menu, you can install the new software using  .
	Remote control	Activate Deactivate	You can use the Home Connect app to access the appliance's functions. If the remote control has been deactivated, only the appliance's operating statuses are displayed in the app. The remote control is only available if you set the rotary selector to light position  . The light goes out after a few minutes.
	Permanent remote start	Activate Deactivate	When permanent remote start is activated, you can start and operate your appliance at any time without prior approval on the appliance. Permanent remote start is only available if you set the rotary selector to light position  . The light goes out after a few minutes.
	Delete network settings		You can delete all network settings from the appliance at any time.
	Appliance information		The display shows: <ul style="list-style-type: none"> ■ MAC address COM module ■ Appliance serial number ■ Software version Depending on the connection type, you can view more information, such as the SSID network name, by touching the arrow button.

10.4 Operating the appliance with the Home Connect app

You can use the Home Connect app to set and start the appliance remotely.



WARNING – Risk of fire!

Combustible objects that are left in the cooking compartment may catch fire.

- ▶ Never store combustible objects in the cooking compartment.
- ▶ If smoke is emitted, the appliance must be switched off or the plug must be pulled out and the door must be held closed in order to stifle any flames.

Requirements

- The appliance is switched on.
- The appliance is connected to the home network and to the Home Connect app.
- In order to be able to set the appliance via the app, the manual or permanent remote start must be selected in the "Remote Control Level" basic setting.

1. Set the function selector to .
2. To activate the remote start, press .
- ✓  appears beside **i**.
3. Configure a setting in the Home Connect app and send it to the appliance.

Notes

- If you open the appliance door within 15 minutes of activating remote start or of the operation ending, the manual remote start is deactivated.

- When you start the oven using the controls on the appliance itself, the remote start function is activated automatically. You can use the Home Connect app to adjust the settings or start a new programme.

10.5 Software update

Your appliance's software can be updated using the software update function, e.g. for the purposes of optimisation, troubleshooting or security updates. To do this, you must be a registered Home Connect user, have installed the app on your mobile device and be connected to the Home Connect server. As soon as a software update is available, you will be informed via the Home Connect app and will be able to start the software update via the app. Once the update has been successfully downloaded, you can start installing it via the Home Connect app if you are in your home network (Wi-Fi). The Home Connect app informs you once installation is successful.

Notes

- The software update consists of two steps.
 - The first step is the download.
 - The second step is the installation on your appliance.
- You can continue to use your appliance as normal while updates are downloading. Depending on your personal settings in the app, software updates can also be set to download automatically.
- Installation takes a few minutes. You cannot use your appliance during installation.
- We recommend that you install security updates as soon as possible.

10.6 Remote diagnostics

Customer Service can use Remote Diagnostics to access your appliance if you contact them, have your appliance connected to the Home Connect server and if Remote Diagnostics is available in the country in which you are using the appliance.

Tip: For further information and details about the availability of Remote Diagnostics in your country, please visit the service/support section of your local website: www.home-connect.com.

10.7 Data protection

Please see the information on data protection.

The first time your appliance is registered on a home network connected to the Internet, your appliance will transmit the following types of data to the Home Connect server (initial registration):

- Unique appliance identification (consisting of appliance codes as well as the MAC address of the Wi-Fi communication module installed).
- Security certificate of the Wi-Fi communication module (to ensure a secure data connection).
- The current software and hardware version of your appliance.
- Status of any previous reset to factory settings.

This initial registration prepares the Home Connect functions for use and is only required when you want to use the Home Connect functions for the first time.



Note: Please note that the Home Connect functions can only be utilised with the Home Connect app. Information on data protection can be retrieved in the Home Connect app.

11 Basic settings















You can configure the basic settings for your appliance to meet your needs.

11.1 Overview of the basic settings



Here you can find an overview of the basic settings and factory settings. The basic settings depend on the features of your appliance.

Display	Basic setting	Selection	Description
	Brightness	Levels 1, 2, 3, 4, 5 ¹ , 6, 7, 8	Set the display brightness
	Standby screen	On ¹ Off <ul style="list-style-type: none"> ▪ Clock ▪ Clock + GAGGENAU logo¹ ▪ Date ▪ Date + GAGGENAU logo ▪ Clock + date ▪ Clock + date + GAGGENAU logo 	Appearance of the standby screen Off: No display. You can use this setting to reduce the standby energy consumption of your appliance. On: Multiple screens can be adjusted. Press ✓ to confirm "On" and use the rotary selector to select the required screen.

¹ Factory setting (may vary according to model)

Display	Basic setting	Selection	Description
	Display screen	Reduced ¹ Standard	"Reduced": After a short time, the display shows only the most important information.
	Touch field colour	Grey ¹ White	Select the colour of the symbols on the touch fields
	Touch field tone type	Tone 1 ¹ Tone 2 Off	Press a touch field to select a signal tone
	Touch field tone volume	Levels 1, 2, 3, 4, 5 ¹ , 6, 7, 8	Set the volume of the touch field tone
	Heating up signal	On ¹ Off	The signal tone sounds when the appliance reaches the required temperature when heating up.
	Signal volume	Levels 1, 2, 3, 4, 5 ¹ , 6, 7, 8	Set the volume of the signal tone
	Time format	AM/PM 24h ¹	Set the 24-hour format set or 12-hour format
	Time	Current time	Set the time
	Clock change	Manual ¹ Automatic	Automatic conversion of the time when changing from summer time to winter time
	Date format	D.M.Y ¹ D/M/Y M/D/Y	Set the date format
	Date	Current date	Set the date. Press ➤ to switch between the year, month and day.
	Temperature unit	°C ¹ °F	Set the temperature unit
	Language	German ¹ French [...] English	Set the language for the text display The system restarts when you change the language. The restart takes a few seconds. After restarting, the appliance closes the basic settings menu.
	Factory settings	Restoring the appliance to the factory settings	The question: "Delete all individual settings made and reset to factory settings?" must be confirmed with ✓ or cancelled with X. When restoring factory settings, the appliance will delete individual recipes. After restoring factory settings, the "Initial settings" menu is displayed.

¹ Factory setting (may vary according to model)

Display	Basic setting	Selection	Description
	Demo mode	On ¹ Off	The demo mode is used for demonstration purposes only. The appliance does not heat up in demo mode. All other functions are available. The "Off" setting must be activated for normal operation. The setting is only possible in the first 3 minutes after connecting the appliance.
	Childproof lock	Not available ¹ Available	Available: You can activate the childproof lock → Page 14.
	Home network	LAN/ WLAN Connection type Connection Connect to app Software update Remote control Permanent remote start Delete network settings Appliance information	Select settings for the connection to the home network and mobile devices. The display shows different setting options depending on the connection status.

¹ Factory setting (may vary according to model)

11.2 Changing the basic settings

1. Turn the function selector to S.
2. Use the rotary selector to select "Basic settings".
3. Press ✓.
4. Use the rotary selector to select the required basic setting.

5. Press _.
6. Use the rotary selector to set the basic setting.
7. Press ✓ to save, or press X to cancel and exit the current basic setting.
8. Turn the function selector to 0 to exit the basic settings menu.
 - ✓ The changes are saved.

12 Cleaning and servicing

To keep your appliance working efficiently for a long time, it is important to clean and maintain it carefully.

12.1 Cleaning agents

To avoid damaging the various surfaces on the appliance, do not use any unsuitable cleaning agents.

WARNING – Risk of electric shock!

An ingress of moisture can cause an electric shock.

- ▶ Do not use steam- or high-pressure cleaners to clean the appliance.

WARNING – Risk of burns!

The appliance and its parts that can be touched become hot during use.

- ▶ Caution should be exercised here in order to avoid touching heating elements.
- ▶ Young children under 8 years of age must be kept away from the appliance.
- ▶ Never touch the ventilation openings.

WARNING – Risk of injury!

Scatched glass in the appliance door may develop into a crack.

- ▶ Do not use any harsh or abrasive cleaners or sharp metal scrapers to clean the glass on the appliance door, as they may scratch the surface.

ATTENTION!

Unsuitable cleaning agents damage the surfaces of the appliance.

- ▶ Do not use harsh or abrasive cleaning products.
- ▶ Do not use cleaning products with a high alcohol content.
- ▶ Do not use hard scouring pads or cleaning sponges.
- ▶ Do not use any special cleaners for cleaning the appliance while it is hot.

Salt contained in new sponge cloths may damage surfaces.

- ▶ Wash new sponge cloths thoroughly before use.
- Using oven cleaner in a hot cooking compartment damages the stainless steel surfaces.
- ▶ Never use oven cleaner in the cooking compartment when it is still warm.
 - ▶ Remove all food remnants from the cooking compartment and the appliance door before you next heat up the appliance.

Suitable cleaning agents

Only use cleaning agents that are suitable for the different surfaces on your appliance.

Appliance door

Area	Suitable cleaning agents	Information
Door panel	<ul style="list-style-type: none"> ▪ Glass cleaner 	Do not use a glass scraper. Clean with a window cloth or a microfibre cloth.
Door seal	<ul style="list-style-type: none"> ▪ Hot soapy water 	Clean with a dishcloth. Do not remove or scrub. Do not use metal scrapers or glass scrapers for cleaning.
Display	<ul style="list-style-type: none"> ▪ Soapy water 	Wipe down using a microfibre cloth or a slightly damp cloth. Do not wipe with a wet cloth

Cooking compartment

Area	Suitable cleaning agents	Information
Cooking compartment inner walls	<ul style="list-style-type: none"> ▪ Hot soapy water 	Clean with a dish cloth and dry with a soft cloth. Stainless steel cleaner that is suitable for the appliance can be obtained from customer service or online. To prevent corrosion, remove any patches of limescale, grease, starch or albumin (e.g. egg white) from stainless steel surfaces immediately. Corrosion may form under such stains. Do not use oven spray or other aggressive oven cleaners or abrasive materials. Scouring pads, rough sponges and pan cleaners are unsuitable. These items scratch the surface. Always dry the cooking compartment after cleaning. Note: Undissolved detergent causes patches to appear when heating up and these patches cannot be removed. Thoroughly remove residues from detergents or care products using clean water before drying the cooking compartment.
Very dirty cooking compartment	<ul style="list-style-type: none"> ▪ Cleaning gel spray for ovens 	Cleaning gel spray for ovens can be obtained from customer service or from the online shop. <ul style="list-style-type: none"> ▪ Do not spray into the steam outlets on the back of the cooking compartment. ▪ The gel must not come into contact with the seals on the door or with the light. ▪ Leave this to work for no more than 12 hours. ▪ Do not use it on hot surfaces. ▪ Rinse off thoroughly with water. ▪ Observe the manufacturer's instructions.
Glass cover for the cooking compartment light	<ul style="list-style-type: none"> ▪ Hot soapy water 	Clean with a dishcloth.
Water tank	<ul style="list-style-type: none"> ▪ Hot soapy water ▪ Dishwasher 	To remove residual detergent after cleaning, rinse thoroughly with clean water. Clean in the dishwasher as necessary. Remove the lid and place the water tank upside down in the dishwasher. Note: Before fitting the lid, ensure that the suction hose is free of residues. → "Check the water tank", Page 23 After cleaning, leave the water tank to dry with the lid open.
Wire racks	<ul style="list-style-type: none"> ▪ Dishwasher ▪ Hot soapy water 	Note: If required, remove the shelf supports for cleaning. → "Removing the shelf supports", Page 21 In the event of heavy soiling, leave to soak and use a brush.
Cooking container, wire rack	<ul style="list-style-type: none"> ▪ Dishwasher ▪ Hot soapy water 	Soak burnt-on remnants and remove with a brush. Light-coloured patches on stainless steel are caused by protein residues. Remove these stains with lemon juice. Rinse thoroughly with clean water.

12.2 Microfibre cloth

The honeycomb microfibre cloth is especially suitable for cleaning easily damaged surfaces, such as glass, glass ceramic, stainless steel or aluminium. The microfibre cloth removes liquid and greasy deposits in one go.

The microfibre cloth can be obtained from customer service or from the online shop.

12.3 Cleaning aid



The cleaning aid loosens stubborn dirt in the cooking compartment and makes cleaning easier.

Always allow the cleaning aid to run to the end. You cannot cancel the cleaning aid.

Preparing the cleaning aid

1. Remove all accessories from the cooking compartment.
2. Remove the shelf supports from the cooking compartment. → Page 21
3. Wipe out the cooking compartment with detergent.
4. Fill the water tank with cold water up to the "Max" mark.
5. Slide the water tank back in as far as it will go.
6. Close the appliance door.

Starting the cleaning aid

1. Set the function selector to S.
 - ✓ The display shows .
2. Press  to confirm.
 - ✓ The appliance displays the cleaning time.
3. Press  to start.
 - ✓ The cleaning time counts down.
 - ✓ The light in the cooking compartment remains switched off.
 - ✓ An audible signal will sound once the cleaning time has elapsed.
 - ✓ The display shows a message.
4. Wipe out the cooking compartment.
5. Empty the water tank and leave it to dry with the lid open.
6. Wipe the cooking compartment dry with a soft cloth.
7. Before using the oven again, remove any detergent residue from the cooking compartment.

Note: If the cleaning aid was cancelled due to a power cut, it must be restarted before using the oven again in order to remove any detergent residues from the appliance.

12.4 Descaling programme

You can use the descaling programme to descale and rinse the appliance fully automatically using special descaling tablets.

ATTENTION!

Limescale may damage the appliance.

- ▶ Descale the appliance regularly.

Using the wrong descaler may damage the appliance.

- ▶ Only use the specified descaling tablets.

The descaling tablet may damage the cooking compartment.

- ▶ Use the descaling tablet for the descaling programme only.
- ▶ Place the descaling tablet into the water tank.
- ▶ Never place the descaling tablet in the cooking compartment or heat it up in the cooking compartment.

The descaling tablets can be obtained from customer service, our website or the online shop.

If you descale the appliance regularly, your appliance will be in a good condition.

Depending on the water hardness and the use of the appliance, a message on the display reminds you to run the descaling programme.

To prevent damage to the appliance, the appliance is disabled after this message has been repeated. You can only use the appliance without any restrictions after you have run the descaling programme.

The descaling programme takes 1 hour 50 minutes from beginning to end. After 1 hour 30 minutes, empty, clean and refill the water tank.

Preparing the descaling programme

WARNING – Risk of scalding!

The descaling tablets may cause chemical burns in the mouth, throat, eyes and on the skin.

- ▶ Follow the safety instructions on the packaging of the descaling tablets.
- ▶ Avoid the skin coming into contact with the descaling tablets.
- ▶ Keep children away from the descaling tablets.



The descaling solution may cause chemical burns in the mouth, throat and eyes or on the skin.

- ▶ Avoid the skin coming into contact with the descaling solution.
- ▶ Keep children away from the descaling solution.
- ▶ Do not drink the descaling solution.
- ▶ The descaling solution must not come into contact with food.
- ▶ Clean the water tank in the dishwasher or thoroughly by hand before you next use the appliance.

ATTENTION!

Using the wrong descaler may damage the appliance.

- ▶ Only use the specified descaling tablets.

1. Set the function selector to S.
2. Use the rotary selector to select the descaling programme.
 - You cannot cancel the descaling programme. Always allow the descaling programme to run to the end.
 - ✓ The display shows .
3. Press  to confirm.
4. Remove all accessories from the cooking compartment.
5. Remove the water tank from the appliance and take off the lid.
6. Remove the descaling tablet from the plastic packaging.

- Place the descaling tablet in the compartment at the back of the water tank.

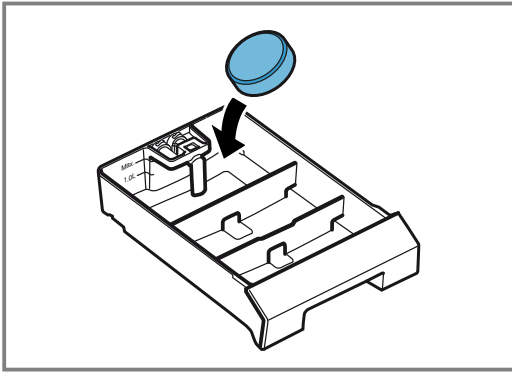

- Position the lid on the tank and click it into place.
- Fill the water tank up to the "Max" mark with 1.7 l cold water.

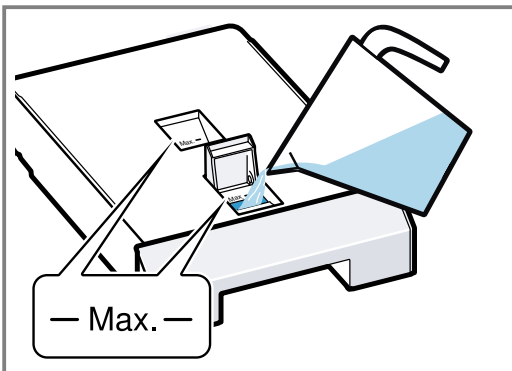

Starting the descaling programme

- Close the appliance door.
- Press ✓ to confirm.
 - ✓ The display shows the descaling time as 1.50 hours.
- Press ▶ to start.
 - ✓ The descaling time counts down on the display.
 - ✓ The light in the cooking compartment remains switched off.
 - ✓ After approx. 1 hour 30 minutes, the display shows a message.

Continuing the descaling programme

⚠ WARNING – Risk of scalding!

- The descaling solution may cause chemical burns in the mouth, throat and eyes or on the skin.
- ▶ Avoid the skin coming into contact with the descaling solution.
 - ▶ Keep children away from the descaling solution.

- ▶ Do not drink the descaling solution.
 - ▶ The descaling solution must not come into contact with food.
 - ▶ Clean the water tank in the dishwasher or thoroughly by hand before you next use the appliance.
- Remove and empty the water tank.
 - Clean the water tank thoroughly.
 - Fill the water tank with 1.7 l water and insert it into the appliance.
 - Press ✓ to confirm.
 - Press ▶ to start the rinsing process.
 - ✓ Once the descaling programme has ended, an audible signal sounds.
 - ✓ The display shows a message.
 - Wipe the cooking compartment dry with a soft cloth.

Cleaning the water tank

- Remove the water tank from the appliance.
- Remove the tank cover.
- Clean the water tank and the tank lid in the dishwasher.

12.5 Removing the shelf supports

The wire racks can be removed for cleaning.

- Place a dishcloth in the cooking compartment to protect the stainless steel from scratches.
- Lift the shelf supports slightly at the front ① and pull them out sideways towards the front ②.

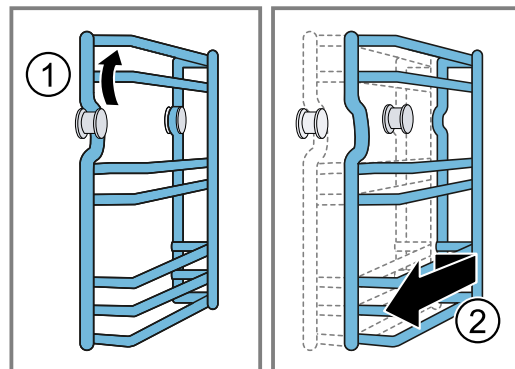

- Clean the shelf supports in hot soapy water or in the dishwasher.

12.6 Fitting the shelf supports

- Fit the shelf supports the right way round.
 - Position the stop position in the rear area of the cooking compartment.
- Slide the back of the shelf supports onto the bolts and attach them at the front.

13 Troubleshooting

You can rectify minor faults on your appliance yourself. Read the troubleshooting information before contacting after-sales service. This will avoid unnecessary costs.



⚠ WARNING – Risk of injury!

- Improper repairs are dangerous.
- ▶ Repairs to the appliance should only be carried out by trained specialist staff.
 - ▶ If the appliance is defective, call Customer Service. → "Customer Service", Page 39

⚠ WARNING – Risk of electric shock!

- Improper repairs are dangerous.
- ▶ Repairs to the appliance should only be carried out by trained specialist staff.
 - ▶ Only use genuine spare parts when repairing the appliance.

13.1 Malfunctions

Fault	Cause and troubleshooting
The appliance is not working.	<p>The mains plug of the power cord is not plugged in.</p> <ul style="list-style-type: none"> ▶ Connect the appliance to the power supply. <hr/> <p>The circuit breaker in the fuse box has tripped.</p> <ul style="list-style-type: none"> ▶ Check the circuit breaker in the fuse box. <hr/> <p>There has been a power cut.</p> <ul style="list-style-type: none"> ▶ Check whether the lighting in your room or other appliances are working. <hr/> <p>Operating error.</p> <ul style="list-style-type: none"> ▶ Switch off the circuit-breaker for the appliance in the fuse box and switch it back on after approx. 60 seconds.
The appliance does not work. Display shows "Appliance locked. Descaling required."	<p>Build-up of limescale in the appliance.</p> <ul style="list-style-type: none"> ▶ Start the descaling programme → <i>Page 20</i>.
Despite descaling, "Please descale" appears on the display.	<p>Build-up of limescale in the appliance, incorrect descaler used.</p> <ol style="list-style-type: none"> 1. Use the specified descaling tablets. 2. Start the descaling programme → <i>Page 20</i>.
The appliance does not start.	<p>The appliance door is not fully closed.</p> <ul style="list-style-type: none"> ▶ Close the appliance door.
The appliance cannot be started via the Home Connect app.	<p>The appliance is not connected to the Home Connect app.</p> <ul style="list-style-type: none"> ▶ Start the connection between the appliance and the Home Connect app. → <i>"Setting up Home Connect", Page 14</i> <hr/> <p>The appliance is connected to the Home Connect app but the remote control function is not activated.</p> <ul style="list-style-type: none"> ▶ Activate the remote control function in the Home Connect settings. → <i>"Home Connect settings", Page 15</i> <hr/> <p>The function selector is not located at the light position.</p> <ul style="list-style-type: none"> ▶ Turn the function selector to the light position.
The appliance does not work. The display shows E182.	<p>The appliance does not receive water.</p> <ol style="list-style-type: none"> 1. Check the water tank. → <i>Page 23</i> 2. If the display shows the error message again, contact customer service → <i>Page 39</i>.
The appliance does not work. The display does not respond. The display shows the symbol for the childproof lock  .	<p>Childproof lock is activated.</p> <ul style="list-style-type: none"> ▶ Deactivate the childproof lock. → <i>Page 14</i>
The appliance cannot be started; the display shows a message.	<p>The water tank is empty.</p> <ul style="list-style-type: none"> ▶ Fill the water tank. → <i>"Fill the water tank", Page 11</i>
The appliance automatically switches off.	<p>Safety switch-off function: No operation for more than 12 hours.</p> <ol style="list-style-type: none"> 1. Press  to confirm the message. 2. Switch off the appliance. 3. Implement the settings again.
The appliance does not heat up; the display shows the symbol for demo mode  .	<p>The appliance is in demo mode.</p> <ul style="list-style-type: none"> ▶ Deactivate the demo mode in the basic settings → <i>Page 16</i>.
Powerful steam release at the top of the door.	<p>You have changed the operating mode.</p> <ul style="list-style-type: none"> ▶ This is normal. <p>No action required.</p>

Fault	Cause and troubleshooting
Powerful steam release at the side of the door.	The door seal is dirty or loose. <ol style="list-style-type: none"> 1. Clean the door seal. 2. Insert the door seal into the groove.
A whistling noise occurs during heating.	Noises may occur during steam generation. <ul style="list-style-type: none"> ▶ This is normal. No action required.
A "plop" sound can be heard during cooking.	Voltage expansion when the temperature difference is large. <ul style="list-style-type: none"> ▶ This is normal. No action required.
Steaming is not possible.	Build-up of limescale in the appliance. The appliance must be descaled to avoid damage to the appliance. <ul style="list-style-type: none"> ▶ Start the descaling programme → <i>Page 20</i>.
The appliance is no longer producing steam correctly.	Build-up of limescale in the appliance. <ul style="list-style-type: none"> ▶ Start the descaling programme → <i>Page 20</i>.
The lighting does not work.	The lighting is defective. <ul style="list-style-type: none"> ▶ Call → "<i>Customer Service</i>", <i>Page 39</i>.
The cooling fan continues running after the appliance is switched off.	The fan run-on removes moisture from the appliance and protects the appliance electronics. The cooling fan may run on for up to 4 hours. <ul style="list-style-type: none"> ▶ This is normal.
The display shows the error message "Exx".	An error occurred. <ol style="list-style-type: none"> 1. If the display shows an error message, turn the function selector to 0. ✓ If the display no longer shows the error message, it was a one-off problem. 2. If the display continues to show or repeatedly shows the error message, contact customer service → <i>Page 39</i> and provide them with the error code.
Water drips out when you open the appliance door.	The collecting channel on the underside of the door panel is full. <ul style="list-style-type: none"> ▶ Dry the collecting channel with a sponge.

13.2 Power failure

Your appliance can bridge a power failure of a few seconds. The operation continues. If the power failure lasts longer and the appliance was operating, the display shows a message. The operation is interrupted.

Switch the appliance back on again after a power failure

1. Turn the function selector to **0**.
2. Switch the appliance back on again as usual.

13.3 Check the water tank

1. Turn the function selector to **0**.
2. Remove the water tank.
3. Remove the tank lid.

4. Remove the suction hose **[a]** and clean it under running water.

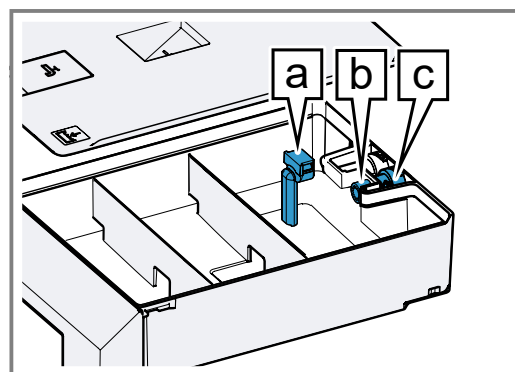

5. Check whether the suction hose is free of residues.
6. Check whether the filter **[b]** is free of residues at the discharge valve **[c]**.

7. Fully fit the suction hose .
 - Ensure that the suction hose is not kinked.

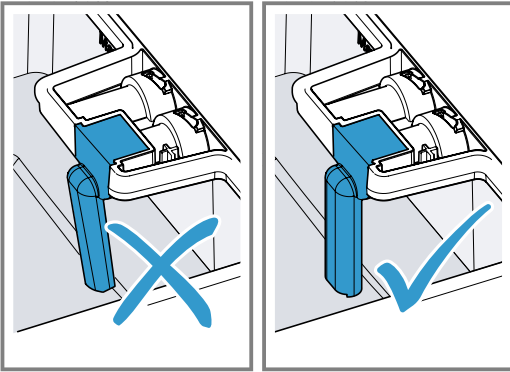

8. Fit the tank lid.

13.4 Demo mode

If the display shows , demo mode is activated. The appliance does not heat up.

Deactivate demo mode

1. To briefly disconnect the appliance from the mains, switch off the household fuse or the circuit breaker in the fuse box.
2. Deactivate demo mode within 3 minutes in the basic settings → Page 16.

14 Disposal

14.1 Disposing of old appliance

Valuable raw materials can be reused by recycling.

1. Unplug the appliance from the mains.
2. Cut through the power cord.
3. Dispose of the appliance in an environmentally friendly manner.
Information about current disposal methods are available from your specialist dealer or local authority.



This appliance is labelled in accordance with European Directive 2012/19/EU concerning used electrical and electronic appliances (waste electrical and electronic equipment - WEEE). The guideline determines the framework for the return and recycling of used appliances as applicable throughout the EU.

15 How it works

Here, you can find the ideal settings for various types of food as well as the best accessories and cookware. We have perfectly tailored these recommendations to your appliance.

15.1 General cooking tips

Take note of the following information when cooking all types of food.

- The cooking times specified are intended as a guide. The actual cooking time depends on the quality and temperature of the food before cooking, as well as its weight and thickness.
- The values given refer to average quantities for 4 people. If you want to prepare a larger amount, expect a longer cooking time.
- Use the cookware specified. If you use other cookware, the cooking time may be longer or shorter.
- If you have not made a particular dish before, start with the shortest specified time. If required, you can continue to cook the food.
- If you are using only one cooking container, slide the cooking container in at the second level from the bottom.
- If you are using the perforated cooking insert or wire rack directly without additional cookware, place the unperforated cooking insert on the first level from the bottom to ensure that the cooking compartment floor does not become too dirty.

- You can use up to three shelf levels at the same time. You can prepare fish, vegetables and desserts simultaneously on different shelf levels without different flavours mixing. The specified cooking times may need to be extended for large quantities of food.
- Ensure that the food does not come into contact with the cooking compartment.
- The appliance door must shut properly. Keep the seal surfaces clean at all times.
- To ensure optimal steam circulation, do not position the racks and containers too closely.
- When cooking very cold foods and when cooking at high temperatures, the cooking container may deform. This deformation has no effect on the function. When the cooking container cools down again, it returns to its original shape.
- When steaming at temperatures up to 100 °C, no preheating is necessary. Place the food in the cold cooking compartment and then switch on the appliance.



















15.2 Vegetables







Take note of the recommended settings for vegetables.

- Vegetables are prepared better in steam than in boiling water: The taste, colour, and consistency are retained better. Virtually none of the water-soluble vitamins and nutrients are washed out.
- All of the information refers to 1 kg washed vegetables.

- To steam vegetables, use the perforated cooking container. Slide the perforated cooking container in at the second level from the bottom. Slide the unperforated cooking into the level below this. This prevents heavy soiling of the cooking compartment. You can use the vegetable broth that is collected here as the basis for a sauce or a vegetable stock.
- Blanch for 4 minutes in the preheated appliance. If you are not serving the vegetables or fruit immediately, chill them in ice water to prevent continued cooking due to residual heat.

Vegetables

Food	Accessory/cookware	Temperature in °C	Type of heating	Humidity in %	Cooking time in min.	Comments
Artichokes, large	Perforated steaming tray	100	 100%	100	35-40	
Artichokes, small	Perforated steaming tray	100	 100%	100	25-30	
Cauliflower, whole	Perforated steaming tray	100	 100%	100	25-30	
Cauliflower, in florets	Perforated steaming tray	100	 100%	100	20-25	
Beans, green	Perforated steaming tray	100	 100%	100	25-30	
Broccoli, in florets, in accordance with EN 60350-1	Perforated steaming tray	90-100	 100%	100	20-25	
Thin vegetable strips and vegetable slices, 1-2 mm	Perforated steaming tray	100	 100%	100	12-15	
Fennel, sliced	Perforated steaming tray	100	 100%	100	20-25	
Vegetable terrine	Perforated steaming tray or Terrine mould	90	 100%	100	50-60	
Peas, frozen, in accordance with EN 60350-1, 3 kg	Perforated steaming tray	100	 100%	100	35-40	
Carrots, in 0.5 cm slices	Perforated steaming tray	100	 100%	100	20-25	
Potatoes, peeled and quartered	Perforated steaming tray	100	 100%	100	30-35	
Kohlrabi, sliced	Perforated steaming tray	100	 100%	100	25-30	
Leeks, sliced	Perforated steaming tray	100	 100%	100	15-20	
Chard	Perforated steaming tray	90	 100%	100	12	
Pak choi	Perforated steaming tray	90	 100%	100	11	
Potatoes boiled in the skin, approx. 50 g each	Perforated steaming tray	100	 100%	100	30-35	
Potatoes boiled in the skin, approx. 100 g each	Perforated steaming tray	100	 100%	100	35-40	
Brussels sprouts	Perforated steaming tray	100	 100%	100	25-30	

Food	Accessory/cookware	Temperature in °C	Type of heating	Humidity in %	Cooking time in min.	Comments
Asparagus, green	Perforated steaming tray	100	 100%	100	15-20	
Asparagus, white	Perforated steaming tray	100	 100%	100	15-30	
Spinach	Perforated steaming tray	100	 100%	100	11	Then sweat in a pan with onions and garlic.
Peeling tomatoes	Perforated steaming tray	100	 100%	100	3-4	Preheat. Cut the tomatoes, and rinse with ice-cold water after steaming.
Courgette blossoms	Perforated steaming tray	100	 100%	100	12	
Mangetouts	Perforated steaming tray	100	 100%	100	10-15	









15.3 Fish

Take note of the recommended settings for fish.

- Steaming is a cooking method that does not use any fat and does not allow the fish to dry out.
- For food hygiene reasons, ensure that fish has a core temperature of at least 62 to 65 °C after cooking. This is also the ideal cooking temperature.
- To ensure that the natural flavour is retained and that less water is removed from the fish, do not season the fish with salt until after cooking.

- When using the perforated cooking container: You can grease the container if the fish sticks too much.
- Slide the unperforated cooking insert into the first level from the bottom to avoid getting fish stock on the cooking compartment surfaces.
- For fillets with skin: Place the fish on the rack or tray with the skin side up – this helps to retain its texture and flavour.

Fish – steaming fish

Food	Accessory/cookware	Temperature in °C	Type of heating	Humidity in %	Cooking time in min.	Comments
Sea bream, whole, 500 g each	Perforated steaming tray	100	 100%	100	20-30	Can be cooked in the swimming position if placed on half a potato.
Fish dumplings, 20-40 g each	Unperforated steam container	90-100	 100%	100	8-12	Line the cooking container with greaseproof paper.
Lobster, cooked, removed from the shell, reheating	Perforated steaming tray	70-80	 100%	100	10-15	
Carp, rare, whole, 1.5 kg	Unperforated steam container	90-100	 100%	100	35-45	In stock
Salmon fillet, 150 g each	Perforated steaming tray	80	 100%	100	20-25	
Salmon, whole, 2.5 kg	Perforated steaming tray	100	 100%	100	65-75	
Blue mussels, 1.5 kg	Perforated steaming tray	100	 100%	100	12-15	Blue mussels are cooked once the shell has opened up.
Pollock, whole, 800 g	Perforated steaming tray	90-100	 100%	100	20-25	
Sea bass, whole, 400 g each	Perforated steaming tray	90-100	 100%	100	20-25	

















15.4 Fish – low-temperature steaming

Use low-temperature steaming to cook fish.

- If you steam the fish at between 70 and 90 °C, it is less likely to be overcooked or to fall apart. Steaming at these temperatures is particularly advantageous for delicate fish.
- The values given for the different types of fish refer to fillets.

- Slide the unperforated cooking insert into the first level from the bottom to avoid getting fish stock on the cooking compartment surfaces.
- Serve on a pre-warmed dish.
- With low-temperature steaming, no preheating is necessary. Place the food in the cold oven and then switch on the appliance.

Fish

Food	Accessory/cookware	Temperature in °C	Type of heating	Humidity in %	Cooking time in min.	Comments
Oysters, 10 pcs	Unperforated steam container	80-90		-	7-10	In stock
Tilapia, 150 g each	Perforated steaming tray	80-90		-	15-17	
Sea bream, 200 g each	Perforated steaming tray	80-90		-	17-20	
Fish fillet, 200-300 g each	Perforated steaming tray	80-90		-	17-20	
Fish terrine	Terrine mould	80-90		-	50-90	
Trout, whole, 250 g each	Perforated steaming tray	80-90		-	17-20	
Halibut, 300 g each	Perforated steaming tray	80-90		-	17-20	
Scallops, 15-30 g each	Unperforated steam container	80-90		-	9-13	The more the scallops weigh, the longer the chosen cooking time should be.
Cod, 250 g	Perforated steaming tray	80-90		-	15-17	
Red snapper, 200 g each	Perforated steaming tray	80-90		-	17-20	
Ocean perch, 120 g each	Perforated steaming tray	80-90		-	15-17	
Monkfish, 200 g each	Perforated steaming tray	80-90		-	15-17	
Sole rolls, stuffed, 150 g each	Perforated steaming tray	80-90		-	17-20	
Turbot, 300 g each	Perforated steaming tray	80-90		-	17-20	
Sea bass, 150 g each	Perforated steaming tray	80-90		-	15-17	
Pikeperch, 250 g each	Perforated steaming tray	80-90		-	17-20	

15.5 Fish and poultry - low-temperature steaming

Take note of the recommended settings for meat and poultry for low-temperature steaming.







- Meat seared at a high temperature develops as it cooks for an extended period at a low temperature. Heating it up gently gives the meat an even, delicate

pink colour throughout (other than a very thin edge) and makes it extraordinarily succulent. No turning or basting is required.

- The cooking times listed are intended as a guide only and depend heavily on the temperature of the meat at the start of cooking and on how long the meat was seared for.
- Take the meat out of the refrigerator 1 hour before you begin preparing it.

- For food hygiene reasons, sear the meat briefly on all sides at a high temperature in the frying pan before cooking it. This gives the meat a crust, which prevents the meat juices from escaping and produces the kind of flavour characteristic of a roast.
- So that the crust formed during searing is not softened by the steam, wrap the seared meat in an oven bag or heat-resistant cling film before you place the meat in the pre-preheated appliance to develop. The meat therefore cooks in its own humidity.
- Season with care: Because the meat develops as it cooks slowly, all of the flavours become more intense.
- When game and horse meat is cooked at low temperatures, its flavour becomes stronger than when prepared the conventional way.
- Use the "Low-temperature steaming" mode .
- Note that the core temperature of the food cannot be higher than the temperature inside the cooking compartment. As a rule of thumb, select an interior temperature that is 10 to 15 °C higher than the required core temperature.
- If your guests arrive late, towards the end of the cooking time, you can reduce the temperature to 60 °C to extend the cooking time. If you want to pause cooking, the temperature in the cooking compartment must be no higher than the required core temperature. Large items can remain in the cooking compartment for 1–1.5 hours, and small items can remain in there for 30–45 minutes.
- Serve on a pre-warmed dish.

Meat/poultry



Food	Accessory/cookware	Temperature in °C	Type of heating	Humidity in %	Cooking time in min.	Comments
Duck breast, medium rare, 350 g each	Unperforated steam container	70-80		100	30-50	After cooking, you can crisp up the skin side quickly in the frying pan.
Entrecôte, medium rare, 350 g each	Unperforated steam container	70		100	20-30	
Leg of lamb, boned, tied, medium rare, 1.5 kg	Unperforated steam container	70-80		100	150-180	Turn in garlic and herbs before cooking in oil
Beef steaks, medium rare, 200 g each	Unperforated steam container	70		100	20-35	
Sirloin, medium rare, 1-1.5 kg	Unperforated steam container	70-80		100	120-180	
Pork medallions, well done, 70 g each	Unperforated steam container	80		100	30-40	

15.6 Meat or sausage - heating

Heat meat or sausage with your appliance.

Meat or sausage



Recommended settings for cooking meat or sausage.

Food	Accessory/cookware	Temperature in °C	Type of heating	Humidity in %	Cooking time in min.	Comments
Smoked pork, cooked, sliced	Unperforated steam container	100	 100%	100	15-20	
Sausages, boiled, e.g. Bologna sausages, Bavarian veal sausages	Unperforated steam container	85-90	 100%	100	10-20	

15.7 Poultry - steaming

Take note of the recommended settings for poultry.

Poultry

Food	Accessory/cookware	Temperature in °C	Type of heating	Humidity in %	Cooking time in min.	Comments
Chicken breast, stuffed, steamed, 200 g each	Perforated steaming tray	100	 100%	100	25-30	Recipe tip: Fill with spinach and sheep's cheese.
Turkey breast fillet, steamed, 300 g each	Perforated steaming tray	100	 100%	100	17-25	
Poussin, quail, pigeon, 300 g each	Perforated steaming tray	100	 100%	100	25-30	

15.8 Sous-vide cooking

When sous-vide cooking, you cook the food under a vacuum at low temperatures between 50 and 95 °C and at 100% steam.

WARNING – Risk of harm to health!

Due to the low sous-vide cooking temperatures, there is a risk to health if you do not follow the instructions for use and hygiene instructions below.

- ▶ Use only fresh, good-quality food.
- ▶ Wash and disinfect your hands. Use disposable gloves or grill tongs.
- ▶ Take extra care when preparing critical food, such as poultry, eggs and fish.
- ▶ Always thoroughly rinse and/or peel fruit and vegetables where necessary.
- ▶ Always keep work surfaces and chopping boards clean. Use different chopping boards for different types of food.
- ▶ Maintain the cold chain. Only interrupt the cold chain briefly to prepare the food. Store vacuum-sealed food back in the refrigerator until it is ready to be cooked.
- ▶ The food is suitable for immediate consumption only. Once the food is cooked, consume it immediately. Do not store it after cooking. Do not store the food in the refrigerator either. The food is not suitable for reheating.
- With this operating mode, no preheating is necessary.
- Sous-vide cooking is a gentle, low-fat method of cooking meat, fish, vegetables and desserts. A vacuum-sealing machine uses heat to hermetically seal the food in a special heat-resistant cooking bag.
- The protective envelope retains the nutrients and flavours. The low temperatures and the direct heat transfer help you to achieve precisely controlled cooking in order to achieve the desired cooking results. It is almost impossible to overcook the food.
- Use the portion sizes listed in the cooking table. For larger quantities and items, adjust the cooking time accordingly. The portions specified for fish, meat and poultry correspond to a single serving. The portions specified for vegetables and desserts correspond to servings for 4 people.

- You can cook on up to two levels. Slide the cooking containers in at levels 1 and 3 to achieve the best cooking results. If you are cooking on just one level, use level 2.
- When using the sous-vide cooking method, only use heat-resistant vacuum-sealing bags designed for this purpose. Do not cook the food in the vacuum-sealing bag in which you bought the food, e.g. portioned fish. These bags are not suitable for sous-vide cooking.
- To ensure an even transfer of heat and a perfect cooking result, use a chamber vacuum-sealing machine that can create a 99% vacuum when vacuum-sealing food.

Vacuum-sealing

When vacuuming, heat-seal the food in a special plastic bag so that it is airtight.

Note the following points when vacuum-sealing:

- There is no/hardly any air in the vacuum-sealing bag.
- The heat-sealed seam is perfectly sealed.
- The vacuum-sealing bag has no holes in it. Do not use a core temperature probe.
- Pieces of meat or fish that have been vacuum-sealed together are not pressed directly against one another.
- You have vacuum-sealed vegetables and desserts as flat as possible.

Before cooking the food, check whether the vacuum in the bag is intact.

If in doubt, place the food into a new bag and vacuum-seal it again. Vacuum-seal food no more than one day before the cooking process. This is the only way to prevent the escape of gases from the food (e.g. from vegetables) which inhibit the transfer of heat, or to prevent the texture of the food from changing, and thus altering how it cooks, as a result of the vacuum pressure.

Quality of the food

The quality of the cooking result is 100% influenced by the quality of the ingredients you use.

Use only fresh, top-quality food. This is the only way to guarantee a consistent cooking result that delivers impeccable flavour.

Cooking

Sous-vide cooking prevents flavours from escaping, intensifying the food's natural flavour. Note that the usual quantities of seasoning and condiments, such as herbs, spices and garlic, will have a much greater effect on the flavour. Start off by halving the quantities you usually use.

If the ingredients are of high quality, it is often sufficient to enclose them in the bag with just a small knob of butter and a little salt and pepper. Generally, the fact that the food's natural flavours intensify during cooking is sufficient on its own to produce a flavourful cooking result.

Do not place the vacuum-sealed food items on top of one another or too close together in the cooking containers. In order to ensure even heat distribution, make sure that you do not touch the food. If you have more than one vacuum-sealing bag, cook on two levels. Remove the vacuum-sealing bags with care after cooking, as hot water accumulates on the bags. Place the unperforated cooking container into the cooking compartment at the level below the perforated cooking container containing the hot food.

Dry the outside of the bag, place it into a clean, unperforated cooking container and cut it open with scissors. Place all of the food, along with its juices, into the cooking container.



The food can be finished off as follows once the sous-vide cooking stage is complete:





- **Vegetables:** Flash fry in a frying pan or on the teppan yaki to give them the flavours you would expect from frying. In doing so, you can effortlessly season the vegetables or mix them with other ingredients without the vegetables cooling down.
- **Fish:** Season and coat with hot butter. Since many types of fish fall apart easily after cooking using the sous-vide method, if you want to flash fry fish, this should be done before the sous-vide cooking stage. Fry the food for longer if has not been sufficiently well cooked during the sous-vide cooking stage.
- **Meat:** Flash fry at a very high temperature for a few seconds only on each side. This gives the meat a nice crust and the flavours you would expect from frying, without overcooking it. You can achieve a particularly good result using a teppan yaki or under the grill.



Note: Dab the meat with a tea towel before placing it into hot oil, in order to avoid fat spitting out of the pan.

Serve the food on pre-heated plates and, if possible, with a hot sauce or butter as sous-vide cooking takes place at relatively low temperatures.



Sous-vide – meat

Food	Accessory/cook-ware	Temperature in °C	Heating function	Cooking time in min.	Comments
Entrecôte, rare, 180 g each	Perforated steaming tray	58		100	Once the meat is cooked, sear it on a teppan yaki or grill it briefly at a high temperature on both sides. This gives the meat a nice crust and the flavours you would expect from frying, without overcooking it.
Entrecôte, medium rare, 180 g each	Perforated steaming tray	63		90	Once the meat is cooked, sear it on a teppan yaki or grill it briefly at a high temperature on both sides. This gives the meat a nice crust and the flavours you would expect from frying, without overcooking it.



Food	Accessory/cook-ware	Temperature in °C	Heating function	Cooking time in min.	Comments
Entrecôte, well done, 180 g each	Perforated steaming tray	70		85	Once the meat is cooked, sear it on a teppan yaki or grill it briefly at a high temperature on both sides. This gives the meat a nice crust and the flavours you would expect from frying, without overcooking it
Veal topside steaks, 160 g each	Perforated steaming tray	60		80	Once the meat is cooked, sear it on a teppan yaki or grill it briefly at a high temperature on both sides. This gives the meat a nice crust and the flavours you would expect from frying, without overcooking it.
Beef steaks, rare, 180 g each	Perforated steaming tray	58		60	Once the meat is cooked, sear it on a teppan yaki or grill it briefly at a high temperature on both sides. This gives the meat a nice crust and the flavours you would expect from frying, without overcooking it.
Beef steaks, medium rare, 180 g each	Perforated steaming tray	63		50	Once the meat is cooked, sear it on a teppan yaki or grill it briefly at a high temperature on both sides. This gives the meat a nice crust and the flavours you would expect from frying, without overcooking it.



Food	Accessory/cookware	Temperature in °C	Heating function	Cooking time in min.	Comments
Beef steaks, well done, 180 g each	Perforated steaming tray	70		45	Once the meat is cooked, sear it on a teppan yaki or grill it briefly at a high temperature on both sides. This gives the meat a nice crust and the flavours you would expect from frying, without overcooking it.
Pork medallions, 80 g each	Perforated steaming tray	63		75	Once the meat is cooked, sear it on a teppan yaki or grill it briefly at a high temperature on both sides. This gives the meat a nice crust and the flavours you would expect from frying, without overcooking it.

Sous-vide – poultry







Food	Accessory/cookware	Temperature in °C	Heating function	Cooking time in min.	Comments
Duck breast, 350 g each	Perforated steaming tray	58		70	Once the breast is cooked, fry the skin side in a hot frying pan until it is crispy.
Foie gras, 1 roll, 300 g each	Perforated steaming tray	80		30	Recipe tip: Prepare the goose liver and mix it with other ingredients. Roll it in foil and prick it several times. Vacuum-seal the roll and leave it to chill for several hours in the refrigerator before cooking it using the sous-vide method.
Chicken breast, 250 g each	Perforated steaming tray	65		60	





Sous-vide – fish/seafood

Food	Accessory/cookware	Temperature in °C	Heating function	Cooking time in min.	Comments
Prawns, 125 g each	Perforated steaming tray	60		30	Recipe tip: Vacuum-seal along with some olive oil, salt and garlic.
Scallops, 20-50 g each	Perforated steaming tray	60		6-10	The more the scallops weigh, the longer the chosen cooking time should be.
Cod, 140 g each	Perforated steaming tray	59		25	







Food	Accessory/cookware	Temperature in °C	Heating function	Cooking time in min.	Comments
Salmon fillet, 140 g each	Perforated steaming tray	58		30	If you wish, you can flash fry the salmon fillet in a hot frying pan once it is cooked.
Pikeperch, 140 g each	Perforated steaming tray	60		20	

Sous-vidé – vegetables

Food	Accessory/cookware	Temperature in °C	Heating function	Cooking time in min.	Comments
Mushrooms, quartered, 500 g	Perforated steaming tray	85		20	Recipe tip: Vacuum-seal along with some butter, rosemary, garlic and salt.
Chicory, halved, 4-6 pieces	Perforated steaming tray	85		40	Recipe tip: Cut the chicory in half. Vacuum-seal along with some orange juice, sugar, salt, butter and thyme.
White asparagus, whole, 500 g	Perforated steaming tray	88		45	Recipe tip: Vacuum-seal along with some butter, salt and a little sugar.
Green asparagus, whole, 600 g	Perforated steaming tray	85		15-20	Recipe tip: Blanch before vacuum-sealing to retain the colour. Vacuum-seal along with some butter, salt and pepper.
Carrots, in 0.5 cm slices, 600 g	Perforated steaming tray	95		35-40	Recipe tip: Vacuum-seal along with some orange juice, curry powder/paste and butter.
Potatoes, peeled, in 2 x 2 cm cubes, 800 g	Perforated steaming tray	95		40	Recipe tip: Vacuum-seal along with some butter and salt. Can easily be used for making dishes such as salad.
Potatoes, skin on, whole or halved, 800 g	Perforated steaming tray	95		50	Recipe tip: Vacuum-seal along with some butter and salt. Wash thoroughly beforehand.

Food	Accessory/cookware	Temperature in °C	Heating function	Cooking time in min.	Comments
Cherry tomatoes, whole or halved, 500 g	Perforated steaming tray	85		15	Recipe tip: Vacuum-seal along with some olive oil, salt and sugar. Mix red and yellow cherry tomatoes together.
Squash, in 2 x 2 cm cubes, 600 g	Perforated steaming tray	90		20-25	The cooking time may vary depending on the type of squash.
Courgettes, in 1 cm slices, 600 g	Perforated steaming tray	85		30	Recipe tip: Vacuum-seal along with some olive oil, salt and thyme.
Mangetouts, whole, 500 g	Perforated steaming tray	85		5-10	Recipe tip: Vacuum-seal along with some butter and salt.

Sous-vide – dessert

Food	Accessory/cookware	Temperature in °C	Heating function	Cooking time in min.	Comments
Pineapple, in 1.5 cm slices, 400 g	Perforated steaming tray	85		70	Recipe tip: Vacuum-seal along with some butter, honey and vanilla.
Apples, peeled, in 0.5 cm slices, 2-4 pcs	Perforated steaming tray	85		10-15	Recipe tip: Vacuum-seal along with some caramel sauce.
Bananas, whole, 2-4 pcs	Perforated steaming tray	65		15-20	Recipe tip: Vacuum-seal along with some butter, honey and a vanilla pod.
Pear, peeled, sliced, 2-4 pcs	Perforated steaming tray	85		30	Recipe tip: Add honey or sugar to sweeten.
Kumquats, halved, 12-16 pcs	Perforated steaming tray	85		75	Recipe tip: Vacuum-seal along with some butter, a vanilla pod, honey and apricot jam. Rinse under warm water, cut in half and deseed.
Vanilla sauce, 0.5 l	Perforated steaming tray	82		18-20	









15.9 Side dishes

Also follow the instructions on the packaging.

Take note of the recommended settings for side dishes.

Side dishes







Food	Accessory/cookware	Temperature in °C	Type of heating	Humidity in %	Cooking time in min.	Comments
Basmati rice, 250 g + 500 ml water	Unperforated steam container	100		100	20-25	







Food	Accessory/cookware	Temperature in °C	Type of heating	Humidity in %	Cooking time in min.	Comments
Bulgur wheat, 250 g + 250 ml water	Unperforated steam container	100	 100%	100	10-15	
Couscous, 250 g + 250 ml water	Unperforated steam container	100	 100%	100	10-15	
Dumplings, 90 g each	Perforated steaming tray or Unperforated steam container	95-100	 100%	100	25-30	
Long-grain rice, 250 g + 500 ml water	Unperforated steam container	100	 100%	100	25-30	
Brown rice, 250 g,+ 375 ml water	Unperforated steam container	100	 100%	100	30-35	
Lentils, 250 g + 375 ml water	Unperforated steam container	100	 100%	100	30-35	
Pasta, fresh, refrigerated, 250 g + 1 l water	Unperforated steam container	100	 100%	100	8-12	
Pasta, stuffed, fresh, refrigerated, 250 g + 1 l water	Unperforated steam container	100	 100%	100	10-15	
White beans, pre-soaked, 250 g + 1 l water	Unperforated steam container	100	 100%	100	55-65	

15.10 Desserts

Note the recommended settings for desserts.

Desserts





Food	Accessory/cookware	Temperature in °C	Type of heating	Humidity in %	Cooking time in min.	Comments
Apple cake with caramel	Springform tin	100	 100%	100	50	
Baked apples	Unperforated steam container	100	 100%	100	20	Peel the apples.
Clafoutis	Springform tin	100	 100%	100	40	
Crème brûlée, 130 g each	Perforated steaming tray + Soufflé dishes	90-95	 100%	100	45-50	
Steamed dumplings or yeast dumplings, 100 g each	Unperforated steam container	100	 100%	100	20-30	Allow steamed dumplings to rise for 30 minutes before steaming. → "Dough proving - leaving to rise", Page 37
Flan or crème caramel, 130 g each	Perforated steaming tray + Soufflé dishes	90-95	 100%	100	35-40	
Semolina pudding, 20 g + 200 ml milk	Unperforated steam container	100	 100%	100	20	

Food	Accessory/cookware	Temperature in °C	Type of heating	Humidity in %	Cooking time in min.	Comments
Yoghurt cake	Loaf tin	100	 100%	100	60	
Compote	Unperforated steam container	100	 100%	100	20-25	E.g. apples, pears, rhubarb Recipe tip: Add sugar, vanilla sugar, cinnamon or lemon juice.
Rice pudding, 200 g rice + 800 ml milk	Unperforated steam container	100	 100%	100	55-60	Allow to cool down for 10 minutes and stir. Recipe tip: Add fruit, sugar or cinnamon.
Muffins	Unperforated steam container	100	 100%	100	30	
Porridge, 40 g + 200 ml milk	Unperforated steam container	100	 100%	100	15-20	
Chocolate cake	Loaf tin	100	 100%	100	40	

15.11 Other

Note the recommended settings.

Other

Food	Accessory/cookware	Temperature in °C	Type of heating	Humidity in %	Cooking time in min.	Comments
Sterilising, e.g. baby bottles, jam jars	Pan support	100	 100%	100	20-25	
Eggs, medium, 5 pcs	Perforated steaming tray	100	 100%	100	12-19	
Royale, 500 g	Glass dish or Pan support	90	 100%	100	25-30	Insert in level 1
Semolina dumplings	Unperforated steam container	90-100	 100%	100	12-15	
Melting chocolate	Heat-resistant cookware	60	 100%	100	15-20	Cover with heat-resistant cling film.

15.12 Reheating – warming



You can use steam assistance to gently warm up food. The food tastes and looks as though it has been freshly cooked. You can even warm and crisp up baked goods from the day before.

- In the combi-steam oven, you can create the perfect conditions for warming cooked food without drying it out. This retains the flavour and quality; the food tastes as though it has been freshly prepared.

- To do this, use the "Reheat" mode .
- Do not cover the food. Do not use any aluminium foil or cling film.
- The figures listed are for portions for one person. Larger quantities of food can also be warmed up in the unperforated cooking insert. This increases the specified cooking times.

Reheating

Food	Accessory/cookware	Temperature in °C	Type of heating	Humidity in %	Cooking time in min.	Comments
Vegetables	Plates	90-100		-	10-15	

Food	Accessory/cookware	Temperature in °C	Type of heating	Humidity in %	Cooking time in min.	Comments
Starchy side dishes	Plates	100		-	10-14	E.g. pasta, quartered potatoes, rice; baked or fried food such as chips or croquettes are not suitable
Plated meals	Plates	100		-	15-20	



15.13 Dough proving - leaving to rise

Your appliance provides the ideal conditions for proving dough and dough mixtures or raw pastries without them drying out.

- To do this, use the "Dough proving" operating mode .

- You do not have to cover the bowl with a damp cloth. Proving only takes half as long as it usually does.
- The cooking time specified is intended as a guide only. Leave the dough to rise until it has doubled its volume.

Dough proving

Food	Accessory/cookware	Temperature in °C	Type of heating	Humidity in %	Cooking time in min.	Comments
Dough mixture, pizza	Bowl	38		-	25	E.g. yeast dough, natural fermentation starter, sourdough
Dough mixture, bread	Bowl	45		-	40	E.g. yeast dough, natural fermentation starter, sourdough
Dough mixture, brioche	Bowl	45		-	55	E.g. yeast dough, natural fermentation starter, sourdough

15.14 Defrosting

In your appliance, you can defrost frozen food gently and faster than in the refrigerator and more evenly than in the microwave.

WARNING – Risk of serious harm to health!

There is a risk of salmonella from meat and poultry. Meat and poultry may transmit germs.

- ▶ When defrosting food from animal sources, you must remove the liquid that escapes during defrosting. Ensure that the liquid that escapes during defrosting never comes into contact with other foods.
- ▶ Slide the unperforated cooking insert under the food. Pour away the liquid that collects in the dish or tray as the meat and poultry defrosts. Then clean the sink and rinse it with plenty of water. Clean the cooking insert in hot soapy water or in the dishwasher.
- ▶ After defrosting, operate the combi-steam oven for 15 minutes with 100% humidity at 100 °C.

- To do this, use the  "Defrost" operating mode.
- The defrosting times specified are intended as a guide only. The defrosting time depends on the size, weight and shape of the frozen food. To reduce the defrosting time, freeze your food flat and in individual pieces.
- Remove the food from the packaging before defrosting.
- Do not defrost more food than you intend to eat on this occasion.
- Remember: Food that has been defrosted may not keep for as long as fresh food and it will spoil more quickly. Prepare defrosted food immediately and cook it thoroughly.
- After half of the defrosting time, turn fish or meat and separate pieces of frozen food, such as berries or pieces of meat. Fish does not need to be fully defrosted. When the surface is soft enough to absorb the spices, the fish is sufficiently defrosted.

Defrosting

Food	Accessory/cookware	Temperature in °C	Type of heating	Humidity in %	Cooking time in min.	Comments
Berries, 300 g	Perforated steaming tray	45-50		-	8-12	

Food	Accessory/cookware	Temperature in °C	Type of heating	Humidity in %	Cooking time in min.	Comments
Roast joint, 1 kg	Perforated steaming tray	45-50	☼	-	90-120	
Fish fillet, 150 g each	Perforated steaming tray	45-50	☼	-	15-20	
Vegetables, 400 g	Perforated steaming tray	45-50	☼	-	12-15	
Goulash, 600 g	Perforated steaming tray	45-50	☼	-	40-55	
Chicken, 1 kg	Perforated steaming tray	45-50	☼	-	60-70	
Chicken thighs, 400 g each	Perforated steaming tray	45-50	☼	-	40-50	

15.15 Preserving food

Preserve fruit and vegetables in jars.

- You can easily preserve fruit and vegetables in your appliance.
- Cook food as soon as possible after purchase or after it has been harvested. Prolonged storage reduces the vitamin content and means that food is on the verge of fermenting.
- Only use fruit and vegetables that are in good condition.
- The appliance is not suitable for preserving meat.

- Carefully check and clean the preserving jars, rubber sealing rings, clips and springs.
- Sterilise the washed jars in your combi-steam oven for 20 to 25 minutes at 100 °C and 100% humidity before preserving.
- Place the sealed preserving jars in the perforated cooking container. They must not be in contact with each other.
- Once the cooking time has elapsed, open the oven door. Do not remove the preserving jars from the cooking compartment until they have completely cooled down.

Preserving food

Food	Accessory/cookware	Temperature in °C	Type of heating	Humidity in %	Cooking time in min.	Comments
Fruit, vegetables, in sealed 0.75 l preserving jars	Perforated steaming tray	100	☼ 100%	100	35-40	
Beans, peas, in sealed 0.75 l preserving jars	Perforated steaming tray	100	☼ 100%	100	120	

15.16 Juicing – berries

Your appliance lets you extract juice from berries effortlessly and cleanly.

- Place the berries into the perforated cooking insert and slide it into the 2nd level from the bottom. Slide the unperforated cooking insert one level underneath to catch any liquid that drips down.

- Leave the berries in the appliance until all of the juice has been extracted.
- You can then place the berries in a tea towel and squeeze to extract the remaining juice.

Juicing (berries)

Food	Accessory/cookware	Temperature in °C	Type of heating	Humidity in %	Cooking time in min.	Comments
Berries	Perforated steaming tray or Unperforated steam container	100	☼ 100%	100	60-120	

15.17 Preparing yoghurt

Use your appliance to make yoghurt.

- You can prepare yogurt using your appliance.
- Allow the milk in the water bath to cool to 40 °C so that the yoghurt cultures are not destroyed.
- Stir some natural yoghurt with identified yoghurt cultures into the milk. Use one to two teaspoons of yoghurt per 100 ml milk.
- When using yoghurt ferment, follow the instructions on the packet.

- Pour the yoghurt into washed jars.
- You can sterilise the washed jars in your appliance at 100 °C and 100% humidity for 20 to 25 minutes. Leave the jars and the cooking compartment to cool down before you pour the yoghurt into the disinfected jars, and place the jars in the appliance.
- Once you have finished making the yoghurt, place it in the refrigerator.
- To make thick yoghurt, add skimmed milk powder to the milk before heating it. Use one to two tablespoons of skimmed milk powder per litre of milk.

Preparing yoghurt

Food	Accessory/cookware	Temperature in °C	Type of heating	Humidity in %	Cooking time in min.	Comments
Yoghurt starter, in sealed jars	Perforated steaming tray	45	 100%	100	300	Recipe tip: Flavour the yoghurt starter with fruit purée, marmalade, honey, vanilla or chocolate, and then increase the preparation time if necessary.

15.18 Preparing bulky food

Recommendation for preparing bulky food.

- To prepare bulky food items, you can remove the side slide-in rack.
- Lift the shelf supports slightly in the cooking compartment at the front and pull them out sideways towards the front.

- Place the rack directly onto the bottom of the cooking compartment and place the food or roasting dish onto the rack. Do not place the food or roasting dish directly onto the bottom of the cooking compartment.

16 Customer Service

Function-relevant genuine spare parts according to the corresponding Ecodesign Order can be obtained from Customer Service for a period of at least 10 years from the date on which your appliance was placed on the market within the European Economic Area.

Note: Under the terms of the manufacturer's warranty the use of Customer Service is free of charge.

Detailed information on the warranty period and terms of warranty in your country is available from our after-sales service, your retailer or on our website.

If you contact Customer Service, you will require the product number (E-Nr.) and the production number (FD) of your appliance.

The contact details for Customer Service can be found in the enclosed Customer Service directory or on our website.

This product contains light sources from energy efficiency class G. These light sources are available as a spare part and should only be replaced by trained specialist staff.

16.1 Product number (E-Nr.) and production number (FD)

You can find the product number (E-Nr.) and the production number (FD) on the appliance's rating plate. You will see the rating plate with these numbers if you open the appliance door.

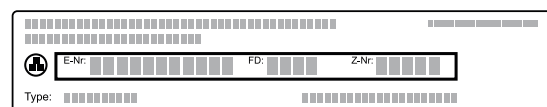

Make a note of your appliance's details and the Customer Service telephone number to find them again quickly.

17 Declaration of Conformity

BSH Hausgeräte GmbH hereby declares that the appliance with Home Connect functionality conforms to the basic requirements and other relevant provisions of Directive 2014/53/EU.

A detailed RED Declaration of Conformity can be found online at www.gaggenau.com among the additional documents on the product page for your appliance.



Hereby, BSH Hausgeräte GmbH declares that the appliance with Home Connect functionality is in compliance with relevant statutory requirements.¹

A detailed Declaration of Conformity can be found online at www.gaggenau.com/gb among the additional documents on the product page for your appliance.¹



2.4 GHz band (2400–2483.5 MHz): Max. 100 mW
5-GHz band (5150–5350 MHz + 5470–5725 MHz): max. 50 mW

	BE	BG	CZ	DK	DE	EE	IE	EL	ES
	FR	HR	IT	CY	LI	LV	LT	LU	HU
	MT	NL	AT	PL	PT	RO	SI	SK	FI
	SE	NO	CH	TR	IS	UK (NI)			

5 GHz WLAN (Wi-Fi): For indoor use only.

AL	BA	MD	ME	MK	RS	UK	UA
----	----	----	----	----	----	----	----

5 GHz WLAN (Wi-Fi): For indoor use only.

17.1 Statement of Compliance for Great Britain

The full Statement of Compliance according to the Product Security and Telecommunications Infrastructure (Security Requirements for Relevant Connectable Products) Regulations 2023 can be found online at www.gaggenau.com/gb/ among the additional documents on the product page for your appliance.

Product type

This statement of compliance covers the products described in this information for use whose model identifier group is seen on the title page. The full model identifier is made up of the characters before the slash in the product number (E no.) which can be found on the rating plate. Alternatively, you can also find the model identifier in the first line of the UK Energy Label.

Name and address of manufacturer

BSH Hausgeräte GmbH, Carl-Wery-Strasse 34, 81739 München, Germany

This statement of compliance is prepared by the manufacturer.

The manufacturer, BSH Hausgeräte GmbH deems that it has complied with

- provision 5.1-1 of ETSI EN 303 645 v2.1.1 and, where relevant, provision 5.1-2 of ETSI EN 303 645 v2.1.1;
- provision 5.2-1 of ETSI EN 303 645 v2.1.1;
- provision 5.3-13 of ETSI EN 303 645 v2.1.1.

Support period

BSH Hausgeräte GmbH will provide security updates that are necessary to maintain the main functions free of charge until at least 28/02/2034.

18 Installation instructions

Observe this information when installing the appliance.



18.1 General installation instructions

Follow these instructions before you start installing the appliance.

WARNING – Risk of injury!

The appliance is heavy.

- ▶ To move the appliance, two people are required.
- ▶ Use only suitable tools and equipment. Sharp-edged parts may be accessible during installation.
- ▶ Wear protective gloves.
- Read this instruction manual carefully.

¹ Only applies to Great Britain

- The safe operation of this appliance can only be guaranteed if it has been installed to a professional standard in accordance with these installation instructions. The installer shall be liable for damages incurred as a result of incorrect installation.
- Switch off the power supply before carrying out any work.
- Check the appliance for damage after unpacking it. Do not connect the appliance if it has been damaged in transit.
- Do not use the door handle for transport or installation.
- When installing, observe the current, valid building regulations as well as the regional power company's regulations.
- Install the appliance in accordance with the installation diagram. Observe the minimum clearances.
- Installation behind cabinet doors: Suitable measures should be taken to ensure these types of doors cannot close during operation. There is a risk of overheating if the door does not remain open during operation or during cooling (fan operation).
- Before starting up the appliance, remove any packaging material and adhesive film from the cooking compartment and the door.
- The dimensions in the figures are in mm.

18.2 Planning notes

Observe the following planning notes before installing the appliance.

- The door direction cannot be reversed.
- The distance from the furniture cavity to the door panel surface is 21 mm.
- The distance from the furniture cavity to the outer edge of the door handle is 72 mm.
- Consider the overhang, including the door handle, when planning to open drawers next to the appliance.
- When planning a corner solution, consider a door opening angle of at least 110°.
- Do not install any other electrical appliance in the cupboard above this appliance.
- This appliance is intended for front flush installation. Even with a minor protrusion of the cabinet panel above the appliance, there is a risk of damage to the cabinet by escaping steam.

18.3 Appliance dimensions

You will find the dimensions of the appliance here

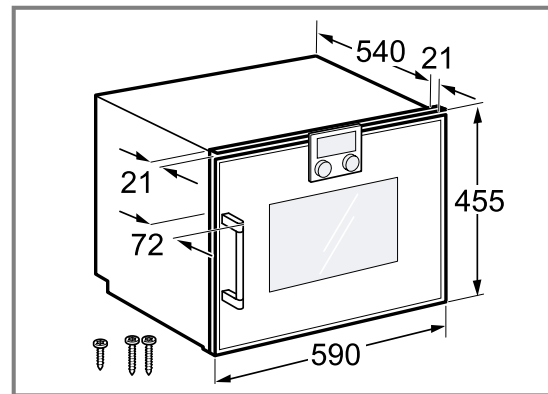

18.4 Preparing the units

Requirement: Fitted units must be heat-resistant up to 90 °C, and adjacent unit fronts up to 70 °C.

1. Ensure that the mains socket is located outside of the built-in niche.
2. Carry out cut-out work on the units and then insert the appliance.
3. After making the cut-outs, remove any shavings. Shavings may impair the function of electrical components.
4. Secure any unsecured units to the wall using a standard bracket.
5. Install the appliance only so high that the customer can remove any accessories effortlessly.

18.5 Electrical connection

In order to safely connect the appliance to the electrical system, follow these instructions.

- The appliance corresponds to protection class I and must only be operated with a protective earth connection.
- The fuse protection must correspond to the power rating specified on the appliance's rating plate and to the local regulations.
- The appliance must be disconnected from the power supply whenever installation work is being carried out.
- The appliance must only be connected using the power cable provided. Plug the power cable fully into the back of the appliance.
- The power cable must only be replaced with a cable from the original manufacturer. The power cable can be obtained from customer service.
- Contact protection must be guaranteed by the installation.

Power cable with a plug with earthing contact

For an appliance with a plug with earthing contact, follow these instructions.

- Connect the appliance only to a correctly installed, earthed socket.
- If the plug with earthing contact can no longer be accessed after installation, an energy-isolating device in the phases must be provided in the permanent electrical installation in accordance with the installation regulations.

18.6 LAN connection to the home network

This appliance can be networked. You can connect the appliance to the home network using a LAN cable. The scope of delivery does not include a LAN cable.

Establishing the LAN connection

1. Before installing the appliance, insert a LAN cable into the socket on the back of the appliance.
2. Use the strain relief to secure the LAN cable in place.

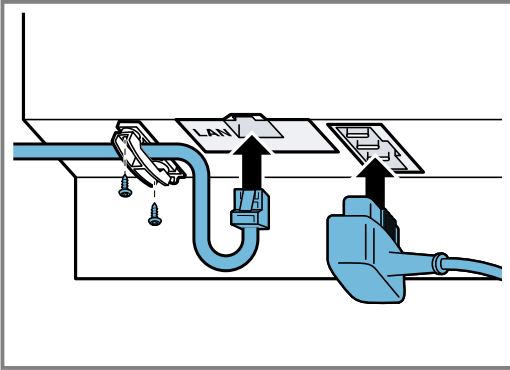

3. Connect the LAN cable to a network connection.

18.7 Installing the appliance in a tall unit

1. Remove the red plastic transport lock from the upper door catch.
 - Undo the screws from behind.
 - Remove the transit bolts.

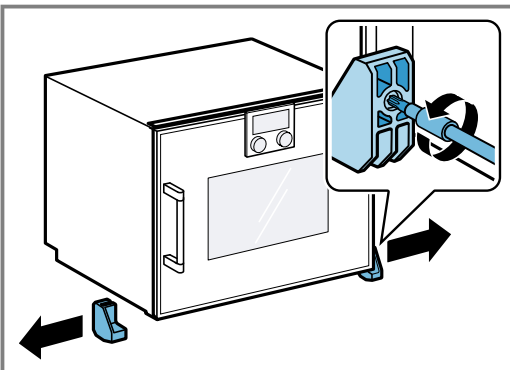

2. When installing 2 appliances next to each other, align both door handles to the centre.

3. When installing 2 appliances on top of each other, observe the clearances.

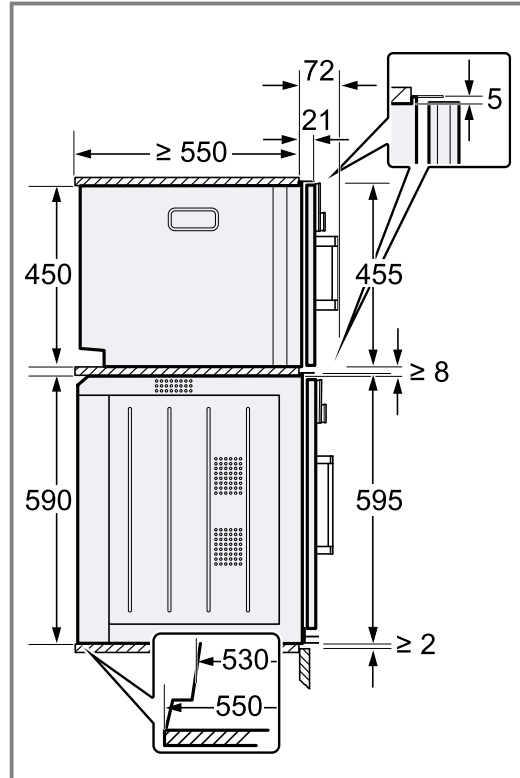

4. Observe the clearances when installing in a tall unit.

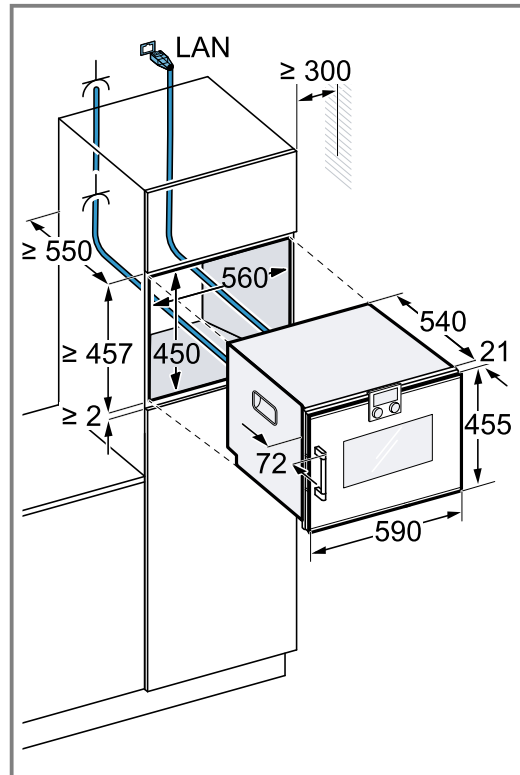

5. If there is no intermediate floor above the appliance, secure the appliance against tipping in the unit. Secure 2 commercially available brackets on both sides in the unit at a depth of 450 mm, 5 mm above the height of the appliance.

6. Push the appliance all the way into the built-in unit.
 - Do not kink or trap the connection cable.

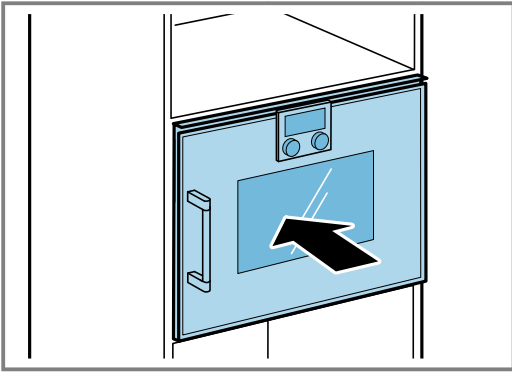

7. Centre the appliance.
8. Use a spirit level to adjust the appliance so that it is perfectly level.

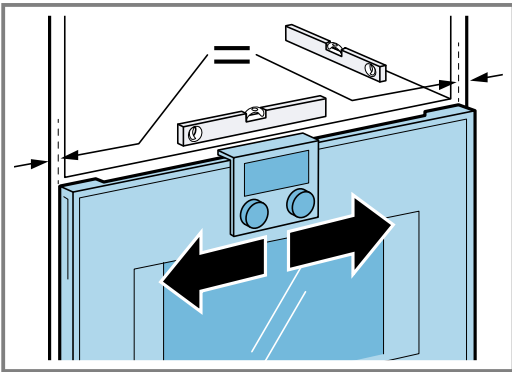

9. Open the appliance door.
10. Secure the appliance using the enclosed screws.
 - First, secure the appliance in place in the unit using the lower screw ①.
 - Tighten the two upper screws ②.

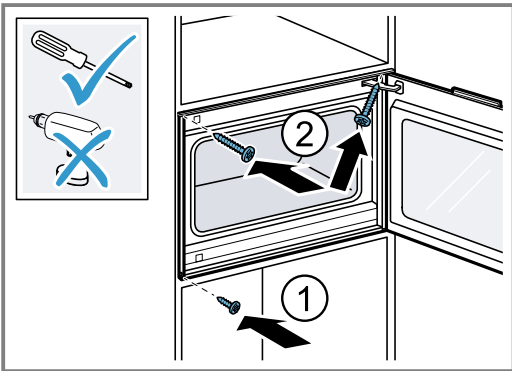

18.8 Aligning the appliance door

The device door is already aligned when the appliance is delivered. Alignment is not normally required. If required, you can adjust the appliance door's alignment at the hinge in order to achieve a precise gap. You cannot adjust the appliance door's height.

Aligning the appliance door

1. Pull the appliance out slightly from its built-in recess.

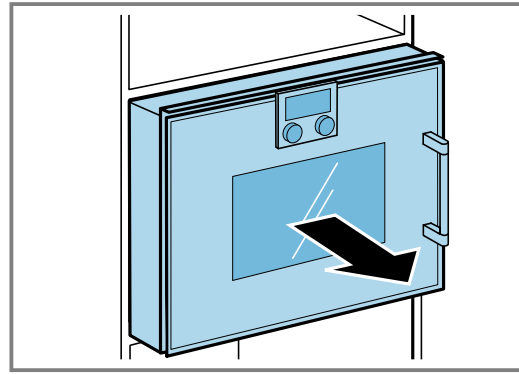

2. Undo the side screw.

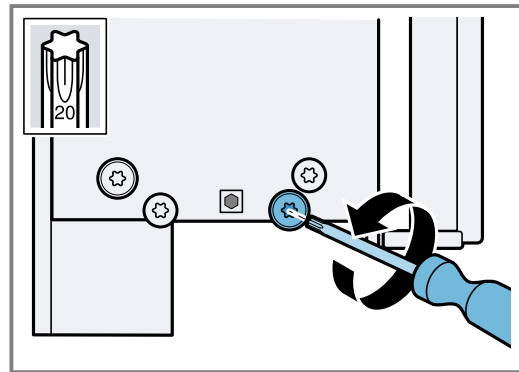

3. Adjust the appliance door using the grub screw. Open the appliance door and then close it again if necessary.

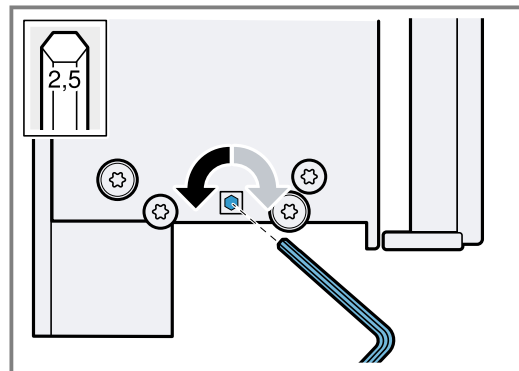
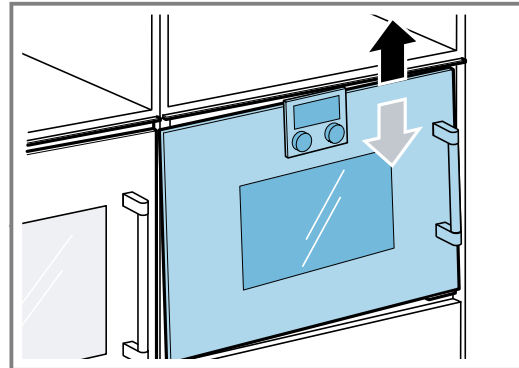

4. Check the alignment.

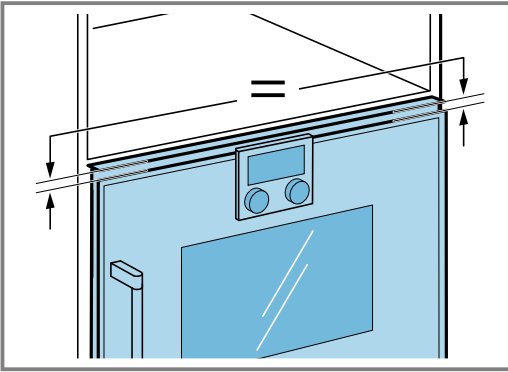

5. Tighten the side screw firmly.

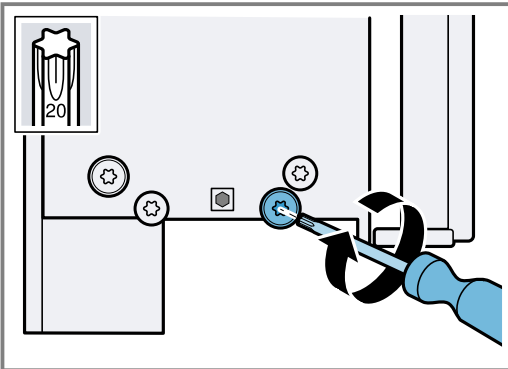

6. Slide the appliance into the built-in recess.

18.9 Combining the appliance with an oven

1. Only combine suitable appliances of the same brand and series.
2. Fit the combi-steam oven first, then the oven.
3. If you want to install the appliance next to an oven, the door handles of both appliances must be in the centre.

18.10 Combining the appliance with a warming drawer

ATTENTION!

Sharp edges on the appliance may damage the panel of the warming drawer.

- ▶ Do not damage the warming drawer cover when sliding the appliance in.

1. Only combine suitable appliances of the same brand and series.
2. Install the warming drawer first.
3. Follow the installation instructions for the warming drawer.
4. Slide the appliance, on the warming drawer, into the built-in cabinet.

18.11 Removing the appliance

1. Disconnect the appliance from the power supply
2. Undo the fastening screws.
3. Lift the appliance slightly and pull it out completely.



A series of horizontal lines for writing, starting from the top right of the pencil icon and extending across the width of the page. There are 25 lines in total, providing a template for text entry.



A series of horizontal lines extending across the page, providing a template for writing. The lines are evenly spaced and cover the majority of the page's vertical space.



A series of horizontal lines spanning the width of the page, providing a structured area for writing. The lines are evenly spaced and extend across the entire width of the page.

BSH Hausgeräte GmbH
Carl-Wery-Straße 34
81739 München, GERMANY
www.gaggenau.com

Valid within Great Britain:
Imported to Great Britain by
BSH Home Appliances Ltd.
Grand Union House
Old Wolverton Road
Wolverton, Milton Keynes
MK12 5PT
United Kingdom

GAGGENAU



9001698463 en (040313)