



WSP 221 710

Glass front in Gaggenau Metallic
Width 24" (60 cm), Height 5 1/2" (14 cm)

200 series warming drawer

WSP 221

- Flush installation
- Handleless drawer
- Push-to-open system
- Hygienic stainless steel interior with glass bottom
- 4 temperature levels ranging 100°F – 175°F
- Keeps food and drinks warm, also for preparing and cooking meals
- Net volume 0.7 cu.ft.

Cooking modes

Defrosting of meals/proofing of yeast dough.
Preheating of small beverage containers.
Keeping meals warm/slow cooking meals.
Warming ovenware

Operation

Rotary knob operation.

Features

Volume capacity: Dinner service for 6 people including ø 9 1/2" plates and soup bowls, additional bowls and a serving dish, depending on size.
Max. load 55 lbs.
Usable interior dimensions: H 3 5/8" x W 18 7/16" x D 18".
Heating under glass bottom for easy cleaning.
Fan for fast, even heat distribution when warming dishes.
Status display, visible in the glass front.
Glass bottom made of safety glass.

Planning notes

Necessary lateral gap between appliance front and cabinet panel of min. 3/16".
The door panel front of the appliance extends 1 3/8" from the cabinet front.
Install BMP/CMP directly above WSP in 23 1/4" cut-out without an intermediate shelf in between.
The power outlet can be planned behind the appliance.

Rating

Total rating: 810 W.
Total Amps: 10 A.
120 V / 60 Hz
Connecting cable 71" with plug.

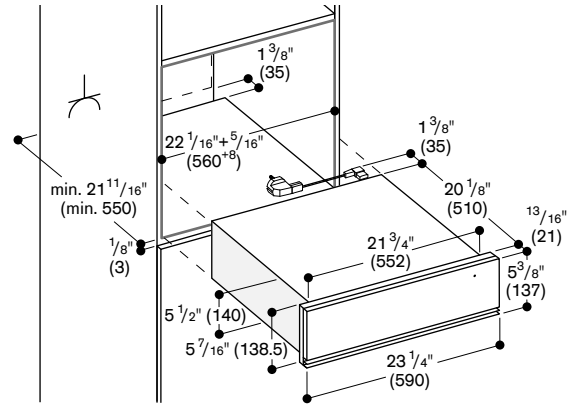

Side view WSP 221 below BSP Combi-steam oven, BMP Combi-microwave oven, CMP espresso machine

