



VP414110
Vario Teppan Yaki 400 series
Stainless steel
Width 38 cm

Precision crafting of 3 mm stainless steel
Cooking directly on the hard-chromed metal surface, without any pots or pans
Solid stainless steel control knob
For surface mounting with a visible edge or for flush mounting
Exact temperature control up to 240 °C
Optimum heat distribution
Can be combined perfectly with other Vario appliances of the 400 series

Cooking zones
 Usable area 31 x 44cm (WxD)

Handling
 Control knobs with illuminated ring, cooking zone and temperature markings.
 Electronic temperature control from 120 °C to 240 °C.

Features
 Two zones, each 1500 W, can be operated together as a complete surface or each half separately. Keep warm setting.
 Easy to clean, similar to a cast pan.

Safety
 Safety shut-off.

Planning notes
 Depending on the type of installation (surface-mounted or flush-mounted, with or without an appliance cover), the specific location of the cut-out and the knob positions may vary.
 If installing with the appliance cover VA 440 or filler strip VA 450 take into account the additional space required for the depth.
 If combining several appliances with at least one appliance cover, the filler strip VA 450 is required to compensate for the depth of the appliance without the appliance cover.
 If combining several Vario appliances of the 400 series, a connection strip VA 420 must be placed between the appliances. Depending on the type of installation, the corresponding connection strip must be provided.
 In the cut-out, the installation system requires the side edge to be at least 10 mm for surface mounting and at least 13 mm for flush mounting. Ensure a continuous cut surface of 90°.
 The bearing capacity and stability, in the case of thin worktops in particular, must be supported using suitable substructures. Take into account the appliance weight and additional loads. Additional instructions for flush mounting:
 Installation is possible in worktops made of stone, synthetics or solid wood. Heat resistance and watertight sealing of the cut edges must be observed. Concerning other materials please consult the worktop manufacturer.
 The groove must be continuous and even, so that uniform placing of the appliance on the gasket is ensured. Do not use discontinuous lining.
 The joint width may vary due to size tolerances of the combinations and of the worktop cut-out.
 If installing several appliances in individual cut-outs allow for a division bar of minimum 50 mm between the individual cut-outs.

Characteristics
Product name/family
 Vario/Domino Teppan Yaki
Built-in / Free-standing
 Built-in
Energy input
 Electric
Type of control
 Electronic
Grill grating material
Required niche size for installation (HxWxD)
 72 x 360 x 490
Width of the product (mm)
 380
Dimensions of the product (mm)
 72 x 380 x 520
Dimensions of the packed product (HxWxD) (mm)
 232 x 455 x 593
Net weight (kg)
 13.562
Grass weight (kg)
 14.8
Residual heat indicator
 Separate
Location of control panel
 Hob front
Basic surface material
Color of surface
 Stainless steel, Stainless steel
Color of frame
 Stainless steel
Approval certificates
 Australia Standards, CCC, CE, China, China ROHS 20, Eurasian, G-Mark, Ukraine, VDE
Length electrical supply cord (cm)
EAN code
 4242006213510

Consumption and connection features
Electrical connection rating (W)
 3000
Gas connection rating (W)
Current (A)
 16
Voltage (V)
 220-240
Frequency (Hz)
 60; 50
2020-07-25
Page 1

Built-in control panel to be integrated in the bottom cabinet at drawer level.
 Panel thickness 16 - 26 mm.
 The drawing "Installation of the control knob" must be observed if the panel is more than 26 mm thick (there must be a recess at the rear).
 A minimum lateral clearance of at least 40 mm from adjacent heat-sensitive furniture or contact surfaces must be observed or thermal insulation fitted.
 Appliance can be snapped into the worktop from above.
 Appliance weight: approx. 14.

Connection
 Total connected load 3.0 KW.
 Plan a connection cable.

Color Variants

VP414110
Stainless steel
Width 38 cm

Included accessories

2 x spatula.

Installation Accessories

VA420000
 Connection strip for combination with other Vario appliances of the 400 series for flush mounting
VA420001
 Connection strip for combination with other Vario appliances of the 400 series for flush mounting with appliance cover/filler strip
VA420010
 Connection strip for combination with other Vario appliances of the 400 series for surface mounting
VA420011
 Connection strip for combination with other Vario appliances of the 400 series for surface mounting with appliance cover/filler strip
VA440010
 Stainless steel appliance cover with mounting strip
VA450400
 Stainless steel filler strip 38 cm

Installation of the control knob; surface mounting

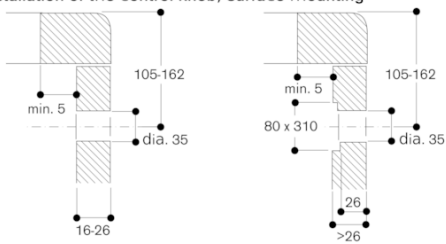

Installation of the control knob; flush installation

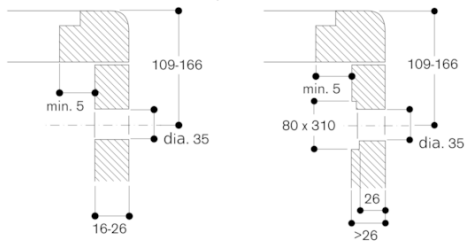

Installation with appliance cover/spacer batten;
 installation standing proud of surrounding surfaces

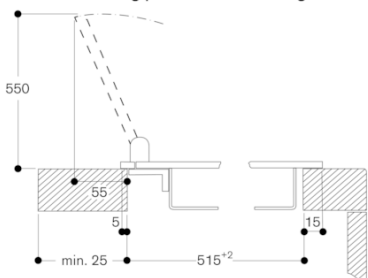

Installation with appliance cover/spacer batten;
 installation flush with surrounding surfaces

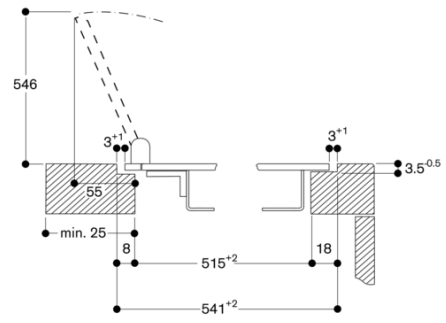

Cross-section

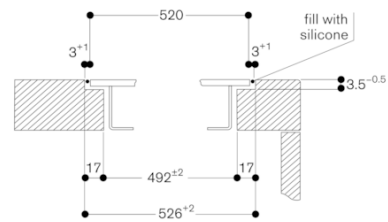

When installing with appliance cover or filler strip, pay attention to the deeper cut-out and the front and rear groove width.

View from above

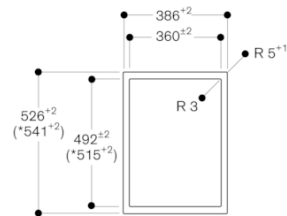

* with appliance cover or filler strip (observe the front and rear asymmetrical support, see separate notes "Installation with appliance cover/filler strip").

Longitudinal section

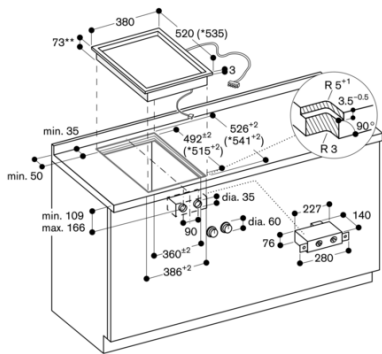
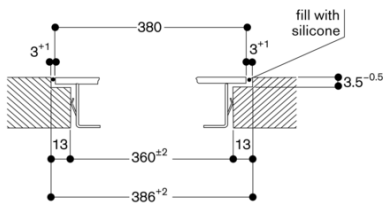

* with appliance cover or filler strip.
 See separate planning notes.
 ** 83 mm in the area of the cable clamp (right, centre).

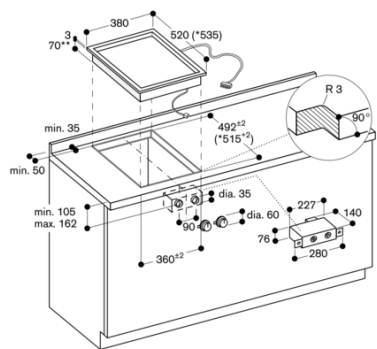

* with appliance cover or filler strip.
 See separate planning notes.
 ** 80 mm in the area of the cable clamp (right, centre).



380	Appliance
3	Connection strip
804	Appliance
1192	Appliance
250	Overhang
1192±2	Cut-out



Without cover

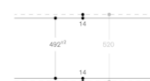

With cover/spacer bottom

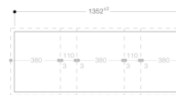

380	Appliance
3	Connection strip
110	VL
3	Connection strip
380	Appliance
3	Connection strip
110	VL
3	Connection strip
380	Appliance
1372	Appliance
250	Overhang
1302±2	Cut-out

VP414110
Vario Teppan Yaki 400 series

Stainless steel

Width 38 cm

2020-07-25

Page 4

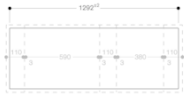

110	VL
3	Connection strip
380	Appliance
3	Connection strip
110	VL
3	Connection strip
380	Appliance
3	Connection strip
110	VL
1292	VL
-20	Overhang
1292	Cut-out

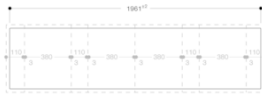

110	VL
3	Connection strip
380	Appliance
3	Connection strip
110	VL
3	Connection strip
380	Appliance
3	Connection strip
110	VL
3	Connection strip
380	Appliance
3	Connection strip
110	VL
1981	VL
-20	Overhang
1981	Cut-out

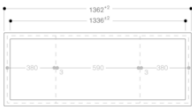

380	Appliance
3	Connection strip
550	Appliance
3	Connection strip
380	Appliance
1362	VL
-20	Overhang
1362	Cut-out
+20	Overhang
-6	Silicone joint
1362	Cut-out with groove

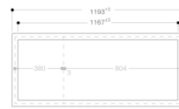

380	Appliance
3	Connection strip
804	Appliance
1183	VL
-20	Overhang
1183	Cut-out
+20	Overhang
-6	Silicone joint
1183	Cut-out with groove



Without cover



With cover/spacer batten

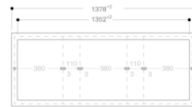

380	Appliance
3	Connection strip
110	VL
3	Connection strip
380	Appliance
3	Connection strip
110	VL
3	Connection strip
380	Appliance
1328	VL
-20	Overhang
1328	Cut-out
+20	Overhang
-6	Silicone joint
1328	Cut-out with groove

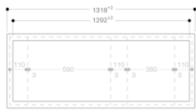

- 110 VL
- 3 Connection strip
- 380 Appliance
- 3 Connection strip
- 110 VL
- 3 Connection strip
- 380 Appliance
- 3 Connection strip
- 110 VL
- 1312
- 20 Overhang
- 1292 Cutout
- +20 Overhang
- 48 Silicone joint
- 1318 Cutout with groove

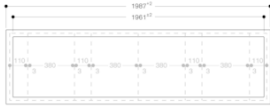

- 110 VL
- 3 Connection strip
- 380 Appliance
- 3 Connection strip
- 110 VL
- 3 Connection strip
- 380 Appliance
- 3 Connection strip
- 110 VL
- 3 Connection strip
- 380 Appliance
- 3 Connection strip
- 110 VL
- 1981
- 20 Overhang
- 1961 Cutout
- +20 Overhang
- 48 Silicone joint
- 1981 Cutout with groove

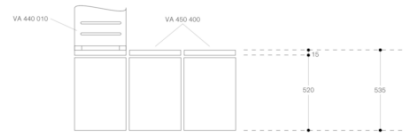

VP414110
 Vario Teppan Yaki 400 series

Stainless steel

Width 38 cm

2020-07-25

Page 6

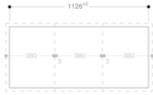

380	Appliance
3	Connection strip
380	Appliance
3	Connection strip
380	Appliance
1146	Appliance
-20	Overhang
1126 ^{±0}	Cutout

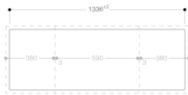

380	Appliance
3	Connection strip
590	Appliance
3	Connection strip
590	Appliance
1306	Appliance
-20	Overhang
1336 ^{±0}	Cutout



Without cover

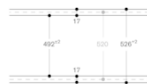

With cover/spacer bottom

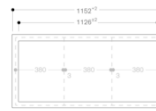

380	Appliance
3	Connection strip
380	Appliance
3	Connection strip
380	Appliance
1146	Appliance
-20	Overhang
1126 ^{±0}	Cutout
+20	Overhang
-45	Slitcut part
1152 ^{±0}	Cut-out with groove

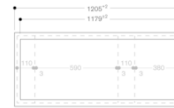

110	VL
3	Connection strip
590	Appliance
3	Connection strip
110	VL
3	Connection strip
380	Appliance
1196	Appliance
-20	Overhang
1176 ^{±0}	Cutout
+20	Overhang
-45	Slitcut part
1200 ^{±0}	Cut-out with groove



110	VL
3	Connection strip
380	Appliance
3	Connection strip
110	VL
3	Connection strip
380	Appliance
1196	Appliance
-20	Overhang
1179 ^{±0}	Cutout

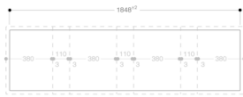

- 380 Appliance
- 3 Connection strip
- 110 VL
- 3 Connection strip
- 380 Appliance
- 3 Connection strip
- 110 VL
- 3 Connection strip
- 380 Appliance
- 3 Connection strip
- 110 VL
- 3 Connection strip
- 380 Appliance
- 1848 Cut-out

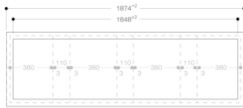

- 380 Appliance
- 3 Connection strip
- 110 VL
- 3 Connection strip
- 380 Appliance
- 3 Connection strip
- 110 VL
- 3 Connection strip
- 380 Appliance
- 3 Connection strip
- 110 VL
- 3 Connection strip
- 380 Appliance
- 1874 Cut-out
- 20 Overhang
- 1848 Cut-out
- 20 Overhang
- 46 Silicone joint
- 1874 Cut-out with groove

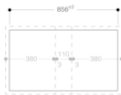

- 380 Appliance
- 3 Appliance
- 110 VL
- 3 Connection strip
- 380 Appliance
- 876 Appliance
- 20 Overhang
- 892 Cut-out

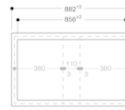

- 380 Appliance
- 3 Connection strip
- 110 VL
- 3 Connection strip
- 380 Appliance
- 876 Appliance
- 20 Overhang
- 892 Cut-out
- 20 Overhang
- 46 Silicone joint
- 892 Cut-out with groove