

AA012811

Recirculation module

AA012811

- For air recirculation.
- Can be combined with ceiling ventilation AC 250 and AC 402.
- Highly efficient odour reduction for cooking applications with complex odour molecules (e.g. fish and seafood).
- The filter retains an extremely high amount of airborne pollen and deactivates allergens, which are retained by the filter.
- Connection piece DN 150 cylindrical.

- For air recirculation.

Can be combined with ceiling ventilation AC 250 and AC 402.

Highly efficient odour reduction for cooking applications with complex odour molecules (e.g. fish and seafood).

The filter retains an extremely high amount of airborne pollen and deactivates allergens, which are retained by the filter.

Connection piece DN 150 cylindrical.

Pipe connection to the front, sideways or at the top.

Recommended minimum gap between filter openings and wall: 100 cm.

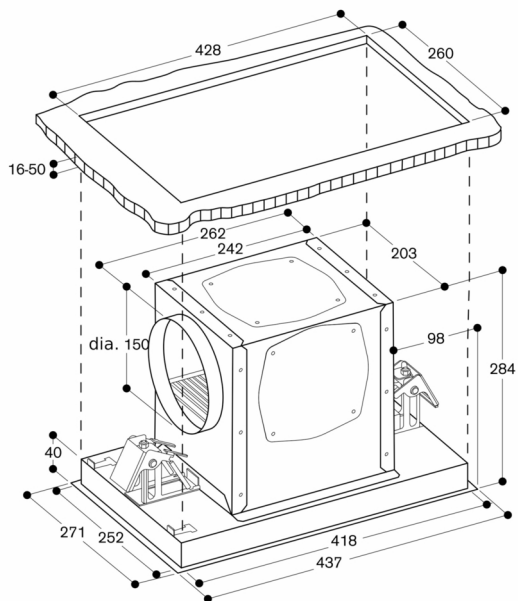

AC 250 with air recirculation module

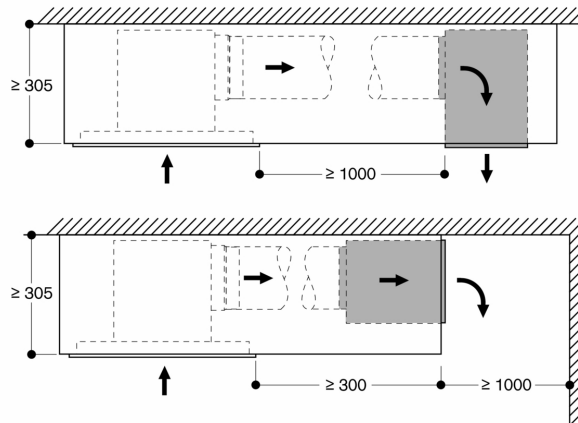

measurements in mm

AC 402 with air recirculation module

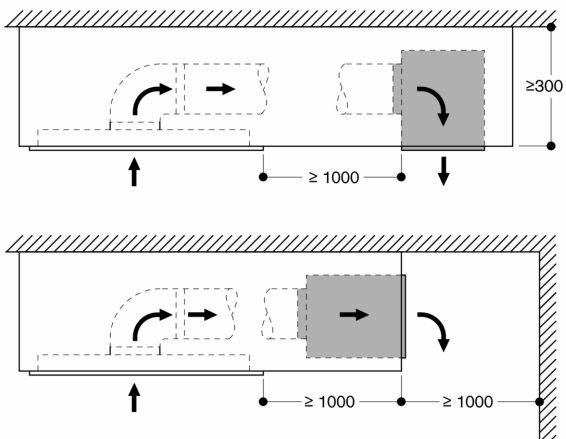

measurements in mm