



BS485111
Combi-steam oven 400 series
Stainless steel-backed full glass door
Width 76 cm
Controls at the bottom

Handleless door / automatic door opening
 Fixed inlet and outlet water connection
 Cleaning system, fully automatic
 Hot air 30 °C to 230 °C can be combined with chosen humidity level of 0%, 30%, 60%, 80% or 100%
 Sous-vide cooking with accurate temperature regulation
 Full surface grill behind glass ceramic, combinable with circulated air up to 230 °C and steam
 TFT touch display
 Panel-free appliance with surface control module
 Steaming without pressure
 Electronic temperature control from 30 °C to 230 °C
 Core temperature probe, removable
 Net volume 44 litres

Heating methods
 Hot air + 100 % humidity.
 Hot air + 80 % humidity.
 Hot air + 60 % humidity.
 Hot air + 30 % humidity.
 Hot air + 0 % humidity.
 Low temperature cooking.
 Sous-vide cooking.
 Full surface grill level 1 + humidity.
 Full surface grill level 2 + humidity.
 Full surface grill + circulated air.
 Full surface grill.
 Defrosting.
 Regenerating.

Handling
 Automatic door opening.
 Rotary knob and TFT touch display operation.
 Option to save individual recipes (incl. core temperature probe).
 Information key with use indications.
 Side-opening door opens up to 180° angle.

Features
 Full surface grill 2000 W behind glass ceramic.
 Steam removal.
 Core temperature probe with automatic shut-off.
 Actual temperature display.
 Timer functions: cooking time, cooking time end, timer, stopwatch, long-term timer.
 Electronic boiling point detection.
 Capacity display for filter cartridge (if connected to GF 111 100 descaling system).
 60 W halogen light on the side.
 Hygienic stainless steel cooking interior.
 3 tray levels.

Safety
 Child lock.
 Safety shut-off.
 Cooled housing with temperature protection.

Cleaning
 Cleaning programme, fully automatic.
 Descaling programme, fully automatic.
 Drying programme.
 Strainer filter, removable.
 Demo cleaning programme.

Planning notes
 Door hinge not reversible.
 No other electrical appliances should be installed above the BS.

Characteristics
Color / Material Front
Construction type
 Built-in
Door opening
 Lateral
Required niche size for installation (HxWxD)
 450-450 x 724-724 x 550
Dimensions
 455 x 752 x 535
Dimensions of the packed product (HxWxD) (mm)
 580 x 820 x 695
Control Panel Material
Door Material
 Stainless steel behind glass
Net weight (kg)
 53.113
Approval certificates
 Australia Standards, CE, Eurasian, G-Mark, Ukraine, VDE
Length of electrical supply cord (cm)
EAN code
 4242006240332
Electrical connection rating (W)
Current (A)
 12
Voltage (V)
 220-240
Frequency (Hz)
 50
Plug type
 fixed connection, no plug
Approval certificates
 Australia Standards, CE, Eurasian, G-Mark, Ukraine, VDE
Number of cavities (2010/30/EC)
 1
Usable volume (of cavity) - NEW (2010/30/EC)
 44
Energy efficiency rating
 A
Energy consumption per cycle conventional (2010/30/EC)
Energy consumption gas oven per cycle conventional (2010/30/EC)
Energy consumption per cycle forced air convection (2010/30/EC)
 0.70
Energy consumption gas oven per cycle forced air convection (2010/30/EC)
Energy efficiency index (2010/30/EC)
 95.9

Consumption and connection features
 created on 2021-02-05
 Page 1

At no point may the outlet hose be positioned higher than the bottom edge of the appliance. The outlet hose must also be at least 100 mm lower than the appliance outlet (see drawing "drain connection").
 Inlet hose can be extended once. The outlet hose must not be longer than a maximum of 5 m.
 The water connection (1) for the inlet hose must always be accessible and not located directly behind the appliance.
 The connection of the outlet hose to the siphon (2) must not be directly behind the appliance and should be accessible.
 The descaling system GF 111 100 (3) must be installed when connecting the appliance if the water hardness exceeds 7° dH.
 The door panel surface of the appliance extends 47 mm from the furniture cavity.
 If the handle (optional accessory) is retrofitted, the outer edge of the door handle extends 94 mm from the furniture cavity.
 Consider the overhang, incl. the door handle where applicable, when planning to open drawers next to the appliance.
 When planning a corner solution, pay attention to the 90° door opening angle.
 To achieve the 550 mm installation depth, the water hoses and connection cable needs to follow the slanted edge on the corner of the housing.
 The mains socket needs to be planned outside of the built-in niche.

Connection
 Total connected load 2.9 KW.
 Only cold water connection.
 Inlet hose 3.0 m with 3/4" (26,4 mm) connection, extendable.
 Outlet hose (ø 25 mm) 3.0 m (HT-Hose).
 Plan a connection cable.

Color Variants
BS485111
Stainless steel-backed full glass door
Width 76 cm

Included accessories
 1 x outlet hose 3m.
 1 x STS tray-GN2/3-punched-40 mm deep.
 1 x STS tray-GN2/3-unpunched-40 mm deep.
 1 x grid.
 1 x pluggable meat probe.
 1 x water inlet hose 3m.
 4 x cleaning cartridge.

Optional accessories
CLS10040
Cleaning cartridges, set of 4
GN114130
Gastronorm insert, stainless steel, GN 1/3
GN114230
Gastronorm insert, stainless steel, GN 2/3
GN124130
Gastronorm insert, stainless steel, GN 1/3
GN124230
Gastronorm insert, stainless steel, GN 2/3
GN340230
Gastronorm roaster in cast aluminium

Installation Accessories
GF111100
Descaling and neutralising filter
GF121110
Filter cartridges
GZ010011
Aqua stop extension (2 m long)

Product Variants
BS484111
Combi-steam oven 400 series
Stainless steel-backed full glass door
Width 76 cm
Controls at the bottom

BS485111
 Combi-steam oven 400 series
 Stainless steel-backed full glass door
 Width 76 cm
 Controls at the bottom
 created on 2021-02-05
 Page 2

View from the back

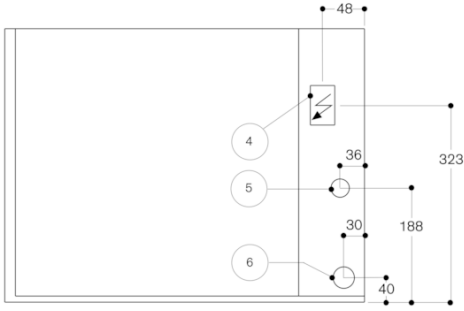

- (4) electric terminal box
- (5) cold-water connection
- (6) water outlet

Drainage connection

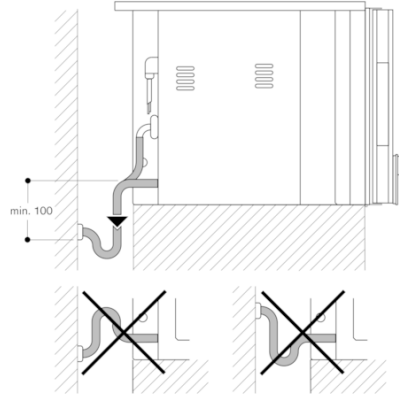

Side view of BS 484/485 above BO

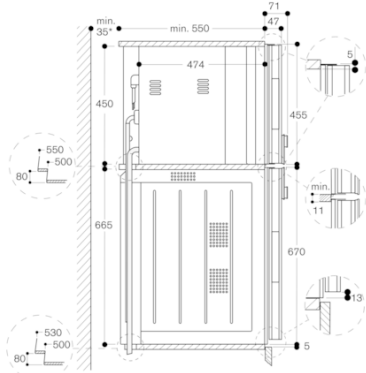

* Only required if the water hoses for the BS steam oven cannot be accommodated in the corner recesses of the appliances.

