



**BSP221111**  
**Steam oven 200 Series**  
**Full glass door in Gaggenau Metallic**  
**Width 60 cm**  
**controls at the top**

#### Color Variants

**BSP221111**  
**Full glass door in Gaggenau Metallic**  
**Width 60 cm**  
**BSP221101**  
**Full glass door in Gaggenau Anthracite**  
**Width 60 cm**  
**BSP221131**  
**Full glass door in Gaggenau Silver**  
**Width 60 cm**

#### Included accessories

1 x grid.  
 1 x STS tray.  
 punched.  
 40 mm deep.  
 1 x STS tray.  
 unpunched.  
 40 mm deep.

#### Optional accessories

**BA046117**  
**Glass tray**  
**BA220360**  
**Cooking container, stainless steel,**  
**unperforated, 35 mm deep, 5 l.**  
**BA220370**  
**Cooking container, stainless steel,**  
**perforated, 35 mm deep, 5 l.**  
**GN114130**  
**Gastronorm insert, stainless steel, GN**  
**1/3**  
**GN114230**  
**Gastronorm insert, stainless steel, GN**  
**2/3**  
**GN124130**  
**Gastronorm insert, stainless steel, GN**  
**1/3**  
**GN124230**  
**Gastronorm insert, stainless steel, GN**  
**2/3**

#### Product Variants

**BSP220111**  
**Steam oven 200 Series**  
**Full glass door in Gaggenau Metallic**  
**Width 60 cm**  
**controls at the top**

Flush installation  
 Water tank  
 Large cavity  
 LED light source  
 External steam generation  
 Steaming without pressure with 100% humidity from 30 °C to 100 °C  
 Sous-vide cooking with accurate temperature regulation  
 TFT touch display  
 Panel-free appliance with surface control module  
 Electronic temperature control from 30 °C to 100 °C  
 59 litres net volume

#### Heating methods

100 % humidity.  
 Sous-vide cooking. Dough proofing.  
 Defrosting. Regenerating. Low temperature steaming.

#### Handling

Rotary knob and TFT touch display operation.  
 Clear text display.  
 Personalisation of automatic programmes.  
 Information key with use indications.  
 Side-opening door opens up to 110° angle.

#### Features

Removable 1.7 litre water tank.  
 Water level warning.  
 Actual temperature display.  
 Timer functions: cooking time, cooking time end, timer, stopwatch, long-term timer (certified by Star-K).  
 Automatic boiling point detection.  
 LED light on the side.  
 Hygienic stainless steel cooking interior.  
 3 tray levels.  
 Home network integration for digital services (Home Connect) either via cable connection LAN (recommended) or wireless via WiFi.  
 The availability of the Home Connect functionality depends on the availability of the Home Connect Services in your country. Home Connect Services are not available in every country – for further information please check: [www.home-connect.com](http://www.home-connect.com)

#### Safety

Child lock.  
 Safety shut-off.  
 Cooled housing with temperature protection.

#### Cleaning

Cleaning aid.  
 Descaling programme for the steam generator.

#### Planning notes

Door hinge not reversible.  
 No other electrical appliances should be installed above the BS.  
 The door panel surface of the appliance extends 21 mm from the furniture cavity.  
 The outer edge of the door handle extends 72 mm from the furniture cavity.  
 Necessary lateral gap between appliance door and furniture panel of min. 5 mm.  
 Consider the overhang, incl. the door handle, when planning to open drawers next to the appliance.

#### Characteristics

**Color / Material Front**  
**Construction type**  
 Built-in  
**Door opening**  
 Lateral  
**Required niche size for installation (HxWxD)**  
 450-450 x 560-560 x 550  
**Dimensions**  
**Dimensions of the packed product (HxWxD)**  
 590 x 660 x 700  
**Control Panel Material**  
 without panel  
**Door Material**  
 Glass  
**Net weight**  
 36.0  
**Approval certificates**  
 Australia Standards, CCC, CE, China, China ROHS 20, Eurasian, G-Mark, Ukraine, VDE  
**Length of electrical supply cord**  
 175  
**EAN code**  
 4242006278236  
**Connection rating**  
 2750  
**Fuse protection**  
 16  
**Voltage**  
 220-240  
**Frequency**  
 50-60  
**Plug type**  
 Gardy plug w/ earthing  
**Approval certificates**  
 Australia Standards, CCC, CE, China, China ROHS 20, Eurasian, G-Mark, Ukraine, VDE

#### Consumption and connection features

created on 2022-08-03  
 Page 1

When planning a corner solution, pay attention to the 110° door opening angle.  
 The main socket needs to be planned outside of the niche.  
 The LAN port can be found at the back on the lower left side.  
 Special accessories (order as spare part):  
 Part No. 17002490 Descaling tablets.

#### Connection

Total connected load 2.8 KW.  
 Connecting cable 1.8 m with plug.  
 Plan a LAN cable.  
 Power consumption standby/display on 0.8 W.  
 Power consumption standby/display off 0.5 W.  
 Power consumption standby/network 1.8 W.  
 Time auto-standby/display on 20 min.  
 Time auto-standby/display off 20 min.#  
 Time auto-standby/network 20 min.  
 Please check the user manual for how to switch off the WiFi module.

BSP221111

Steam oven 200 Series

Full glass door in Gaggenau Metallic

Width 60 cm

controls at the top

created on 2022-08-03

Page 2

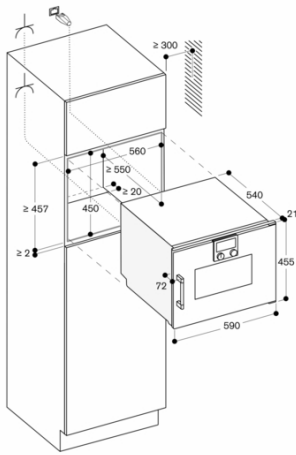

Socket  
measurements in mm

Side view of BSP 220/250 above BOP

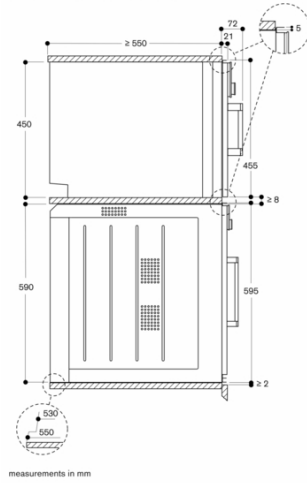

measurements in mm

**GAGGENAU**