



AI442160

AA400510:

Window contact switch with cable

AA442110:

Active charcoal filter for AA 442 810

AA442810:

Recirculation module w.active charcoal

AD442396:

Ceiling Collar Stainless Steel Island

AD442016:

Chimney exhaust air stainless steel

AD442026:

Chimney exhaust air stainless steel

AD442116:

Chimney recirculation stainless steel

AD442126:

Chimney recirculation stainless steel

Island cooker hood 400 series

160 cm, Stainless steel

AI442160

Professional technology hood combined with classic Gaggenau design

Highly efficient extraction of cooking vapours due to large vapour collection area

Motorless, can be combined with Gaggenau BLDC remote fan units

Angled baffle filter with high grease absorption
Function for automatic, sensor-controlled power adjustment depending on the build-up of cooking vapours

Dimmable, neutral white surface LED light for ideal illumination of the whole cooktop

Air extraction or air recirculation system

Air recirculation module with activated charcoal filter: quiet and highly efficient air recirculation solution with odour reduction as in air extraction mode and long replacement intervals

Output

Power levels depend on the remote fan unit.

Features

3 electronically controlled power levels and 1 intensive mode.

Automatic function with sensor-controlled run-on function.

Grease filter saturation indicator.

Baffle filter, dishwasher-safe.

Neutral white surface LED light (3500 K), continuously dimmable.

Lamp output 4 x LED light bars 10W.

Illuminance 1390 lx.

Consumption Rates

Sound level min/max (intensive) according to EN 61591: 45 / 72 dB(A)

Performance

Refer to the table on page XX for the matching remote fan units for air recirculation or air extraction mode.

The two-part chimney including the mounting kit must be ordered as an installation accessory.

Connection to the respective appliances via network cable.

Clearance above gas appliances min. 70 cm.

Clearance above electric appliances min. 60 cm.

Air recirculation module with 2 activated charcoal filters is installed in the inner chimney.

Special air recirculation chimneys are available for this.

When installing a ventilation hood with air extraction mode and a chimney-vented fireplace, the power supply line of the ventilation appliance needs a suitable safety switch.

Connection

Total connected load 50 W.

Connecting cable 1.8 m, pluggable.

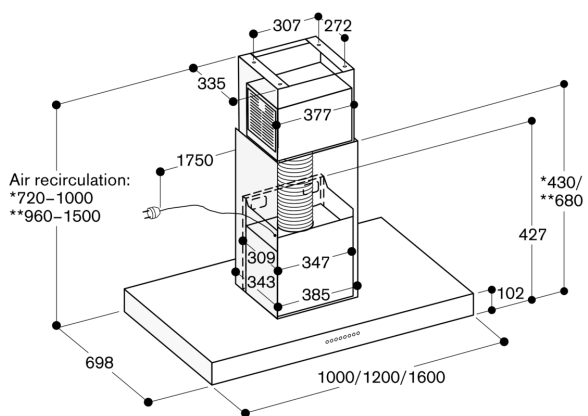

- * With air recirculation chimney AD 442 116, suitable for ceiling heights from 2.35 m to 2.60 m.
- ** With air recirculation chimney AD 442 126, suitable for ceiling heights from 2.60 m to 3.10 m; Specifications refer to the distance of 1.60 m from the floor to the lower edge of the hood.

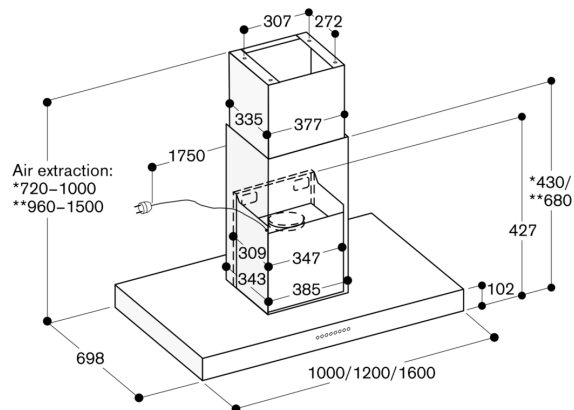

- * With air extraction chimney 442 016, suitable for ceiling heights from 2.35 m to 2.60 m.
- ** With air extraction chimney AD 442 026, suitable for ceiling heights from 2.60 m to 3.10 m; Specifications refer to the distance of 1.60 m from the floor to the lower edge of the hood.