



BS455110

GN114130:

GN insert unperf, st. steel, GN1/3, 40mm

GN114230:

GN insert unperf, st. steel, GN2/3, 40mm

GN124130:

GN insert perf, st. steel, GN1/3, 40mm

GN124230:

GN insert perf, st. steel, GN2/3, 40mm

GN144130:

GN insert 1/3 unperf, non-stick, 40mm

GN144230:

GN insert 2/3 unperf, non-stick, 40mm

GN154130:

GN insert 1/3 perf, non-stick, 40mm

GN154230:

GN insert 2/3 perf, non-stick, 40mm

GN340230:

Gastronorm roaster GN 2/3

GN410130:

GN lid stainless steel 1/3

GN410230:

GN lid stainless steel 2/3

GR220046:

Grid for steam oven

BA476310:

Accessory 400series, handle60cm BS/BM ss

Built-in compact oven with steam function 400 series

60 x 45 cm, Door hinge: Left, Stainless steel behind glass

BS455110

- Handleless door / automatic door opening
- Water tank
- Hot air 30 °C to 230 °C can be combined with chosen humidity level of 0%, 30%, 60%, 80% or 100%
- TFT touch display
- Panel-free appliance with surface control module

- Handleless door / automatic door opening
Water tank
Hot air 30 °C to 230 °C can be combined with chosen humidity level of 0%, 30%, 60%, 80% or 100%

TFT touch display
Panel-free appliance with surface control module
Steaming without pressure
Electronic temperature control from 30 °C to 230 °C
Core temperature probe, removable
Net volume 42 litres

Heating methods

Hot air + 100 % humidity.
Hot air + 80 % humidity. Hot air + 60 % humidity.
Hot air + 30 % humidity. Hot air + 0 % humidity.
Dough proofing. Defrosting. Regenerating. Low temperature cooking.

Capacity

Automatic door opening.
Rotary knob and TFT touch display operation.
Clear text display.
Option to save individual recipes (incl. core temperature probe).
Information key with use indicators.
Side-opening door opens up to 180° angle.

Features

Removable 1.3 litre water tank.
Water level warning.
Core temperature probe with automatic shut-off.
Actual temperature display.
Timer functions: cooking time, cooking time end, timer, stopwatch, long-term timer.
Electronic boiling point detection.
48 W halogen light on the side.
Hygienic stainless steel cooking interior.
4 tray levels.

Safety

Child lock.
Safety shut-off.
Cooled housing with temperature protection.

Cleaning

Cleaning aid.
Drying program.
Descaling programme.
Grease filter, dishwasher-safe.

Performance

Door hinge not reversible.
No other electrical appliances should be installed above the BS.

The door panel surface of the appliance extends 47 mm from the furniture cavity.

If the handle (optional accessory) is retrofitted, the outer edge of the door handle extends 94 mm from the furniture cavity.

Consider the overhang, incl. the door handle where applicable, when planning to open drawers next to the appliance.

When planning a corner solution, pay attention to the 90° door opening angle.

To achieve the 550 mm installation depth, the connection cable needs to follow the slanted edge on the corner of the housing.

The mains socket needs to be planned outside of the built-in niche.

Connection

EU 65/2014

Total connected load 1.9 KW.

Plan a connection cable.

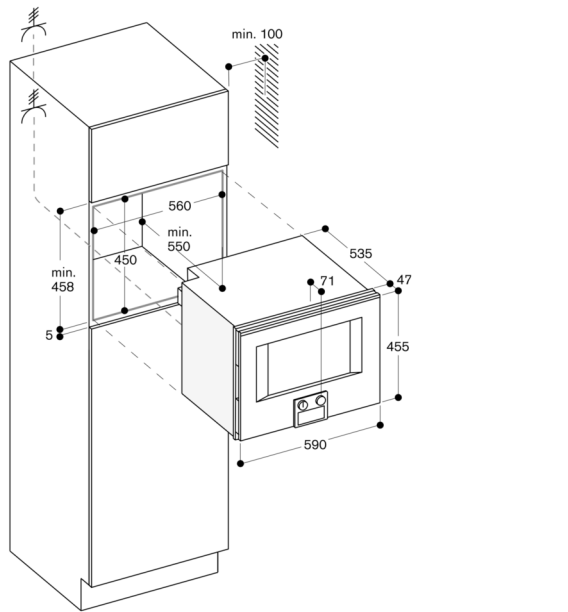

Side view of BS 454/455, BM 454/455 above BO

