



VL414111
Vario downdraft ventilation 400 series
stainless steel
Width 11 cm
Air extraction / Air recirculation
Without motor and control knob



Highly efficient ventilation system at the cooktop
 Flexible power distribution, precise extraction of cooking vapours only at the open ventilation elements
 Can be combined perfectly with other Vario appliances of the 400 series
 Precision crafting of 3 mm stainless steel
 For surface mounting with a visible edge or for flush mounting
 Motorless, can be combined with Gaggenau BLDC remote fan units

Output
 Power levels depend on the remote fan unit, see table on page XX.

Features
 Manual opening of the ventilation element.
 Closing element made of stainless steel, dishwasher-safe.
 Metal grease filter, dishwasher-safe.
 No connecting piece included.

Consumption data
 Consumption data is referred to a configuration with the remote fan unit AR 403 122.
 Energy consumption 53.2 kWh/year.
 Ventilation efficiency class A.
 Illumination efficiency class -.
 Grease filter efficiency class C.
 Sound level min. 56 dB / max. 68 dB normal mode.

Planning notes
 Refer to the table on page XX for the matching remote fan units for air recirculation or air extraction mode.
 Secure the control unit to the side panel of the cabinet, not to the base of the cabinet or the kitchen floor.
 For each VL one remote fan unit is recommended.
 Maximum cooktop width between two VL: 60 cm.
 Appliance can be snapped into the worktop from above. Additional fixing by clamps accessible from bottom up, clamping range 30-50 mm.
 If combining several Vario appliances of the 400 series, a connection strip VA 420 must be placed between the appliances. Depending on the type of installation, the corresponding connection strip must be provided.
 The bearing capacity and stability, in the case of thin worktops in particular, must be supported using suitable substructures. Take into account the appliance weight and additional loads.
 Additional instructions for flush mounting:
 Installation is possible in worktops made of stone, synthetics or solid wood. Heat resistance and watertight sealing of the cut edges must be observed. Concerning other materials please consult the worktop manufacturer.
 The groove must be continuous and even, so that uniform placing of the appliance on the gasket is ensured. Do not use discontinuous lining.
 The joint width may vary due to size tolerances of the combinations and of the worktop cut-out.

Characteristics
Product name/family
Color chimney
Typology Downdraft
Approval certificates , CE, Eurasian, G-Mark, Ukraine, VDE
Length electrical supply cord
Required niche size for installation (HxWxD) 170mm x 90.0mm x 492mm
Height of the chimney
Height of product, without chimney
Net weight 2.2
Type of control Electronic
Number of speed settings
Maximum output air extraction 540
Boost position output recirculating
Maximum output recirculating air 470
Boost position air extraction
Number of lights
Noise level 68
Diameter of air outlet 150
Grease filter material Washable stainless steel
Odour filter No
Operating Mode Convertible
Delay Shut off modes
Required accessories
Optional accessories AA414010
Type of lamps used
Total power of the lamps
Grease filter type Kassette
Clean filter reminders
Connection Rating
Fuse protection
Voltage 220-240
Frequency 60; 50
Plug type
Installation typology Built-in
Universal Product Code 825225921349
Material body Stainless steel
Approval certificates , CE, Eurasian, G-Mark, Ukraine, VDE
Length of electrical supply cord (in)
Plug type
Dimensions of the product, with chimney (if exists) (in) / x 4 5/16 x 20 15/32
Dimensions of the packed product 6.88 x 15.55 x 23.62
Height of the chimney (in)
Vertical rise height
Required distance above cooktop/ ranges
Net weight 5.000
Gross weight 15.000
Motor location without motor
Maximum output recirculating air
Diameter of air duct (in) top
Diameter of air duct (in) back
Discharge direction downward
No-return airflow flap No
Length electrical supply cord
Dimensions of the product, with chimney (if exists) x 110.0 x 520.0
Dimensions of the packed product (HxWxD) 175 x 395 x 600
Height of the chimney (in)

If installing several appliances in individual cut-outs allow for a division bar of minimum 50 mm between the individual cut-outs.
 If operated next to gas appliances, the ventilation moulding AA 414 010 is recommended to ensure maximum performance of the cooktop.
 If installed next to gas appliances, flat ducts must not be used for the piping up to the fan unit.
 If installed next to VP 414, the flat duct must not be positioned underneath the VP 414.

Connection
 Connection cable 2.0 m between ventilation element VL 414 and control knob AA 490.

Color Variants

VL414111
 stainless steel
 Width 11 cm

Optional accessories

AA414010
 Air baffle for combination with gas cooktops

Installation Accessories

VA420000
 Connection strip for combination with other Vario appliances of the 400 series for flush installation

VA420010
 Connection strip for combination with other Vario appliances of the 400 series for surface installation

VL414111
 Vario downdraft ventilation 400 series
 stainless steel
 Width 11 cm
 Air extraction / Air recirculation
 Without motor and control knob
 2022-05-16
 Page 2

AS 070 001

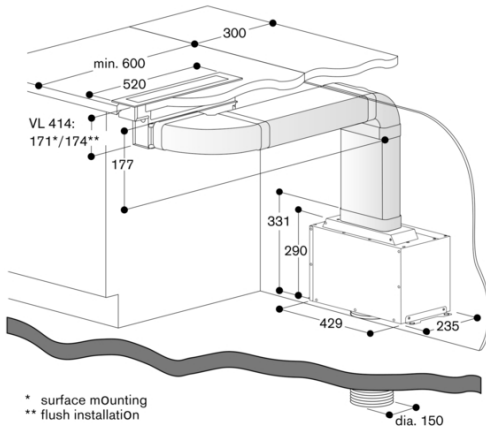
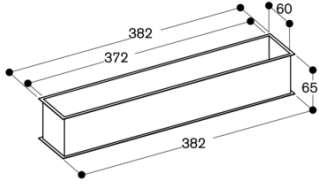

VL 414 with AD 724 040/041

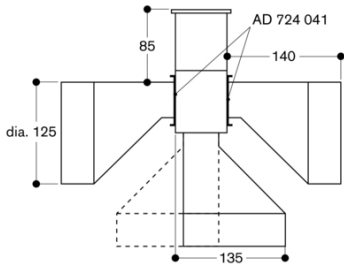

Longitudinal section

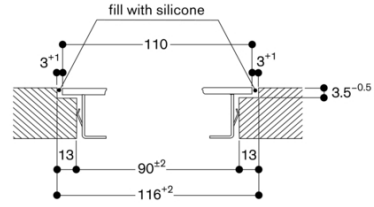

View from above

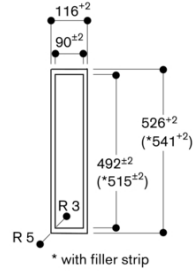

AS 070 000

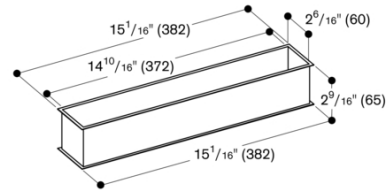

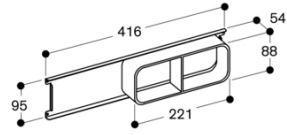

Cross-section

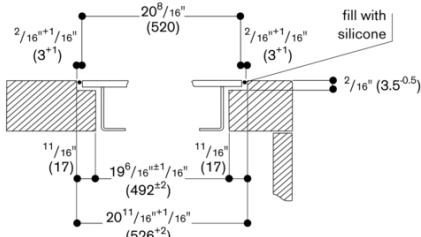

When installing with appliance cover or spacer batten, pay attention to the deeper cut-out and the front and rear groove width.

View from above

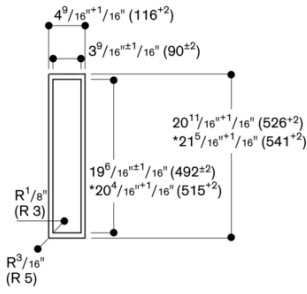

* With spacer batten

Longitudinal section

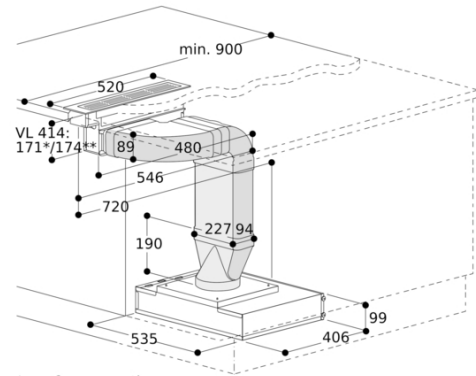
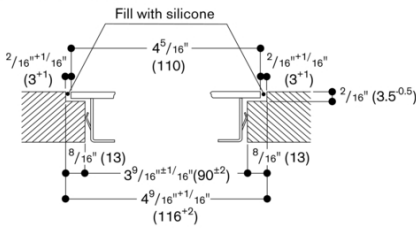

* surface mounting
 ** flush mounting

VL 414 with AD 724 042/041

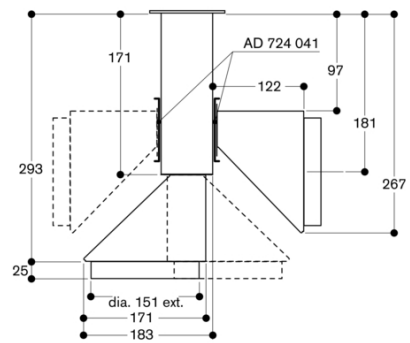

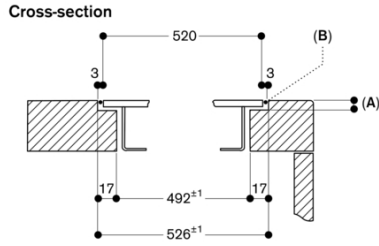

A: 3.5^{0.5}
 B: Fill with silicone
 measurements in mm

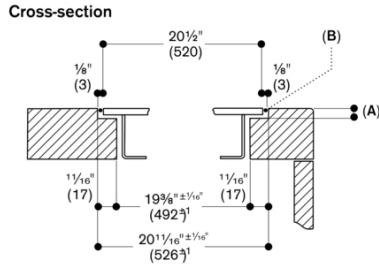

A: 1/8" (3.5^{0.5})
 B: Fill with silicone
 measurements in inches (mm)

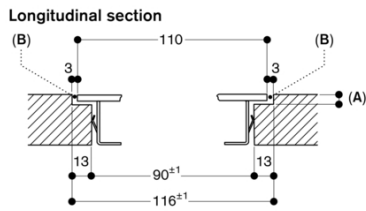

A: 3.5^{0.5}
 B: Fill with silicone
 measurements in mm

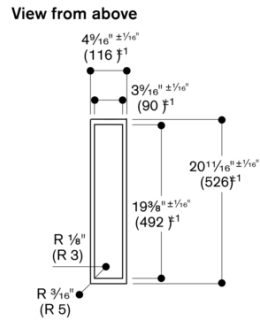

measurements in inches (mm)

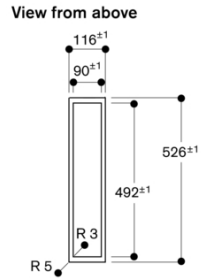

measurements in mm

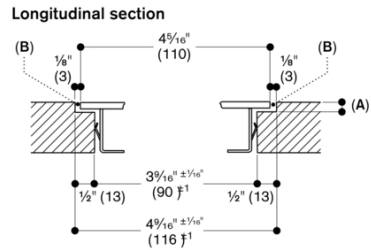

A: 1/8" (3.5^{0.5})
 B: Fill with silicone
 measurements in inches (mm)

VL414111
 Vario downdraft ventilation 400 series
 stainless steel
 Width 11 cm
 Air extraction / Air recirculation
 Without motor and control knob
 2022-05-16
 Page 6

