



BO470112

- 2 x enamel baking tray, suit. pyrolytic clean
- 1 x rotary spit
- 1 x glass pan
- 1 x grill shelf
- 1 x grill tub with grid
- 1 x pluggable meat probe

BA016105:

1 telescopic shelf rail, for 60cm oven

BA026105:

Grill tray, for oven BO47*

BA026115:

Baking tray, for 60cm oven

BA036105:

wire rack, for 60cm oven

BA046117:

Glass tray, for 60cm oven

BA056115:

Heating elem. 230 V, for 60cm oven

BA056133:

Baking stone for 60 cm oven

BS020002:

Set of 2 pizza paddles

GN340230:

Gastronorm roaster GN 2/3

oven 400 series

60 x 60 cm, door hinge: right, Stainless steel behind glass

BO470112

Handleless door / automatic door opening / door opening via voice assistant possible
 Pyrolytic system
 17 heating methods with core temperature probe, rotisserie spit and baking stone function
 Automatic programmes
 Core temperature probe with estimation of cooking time
 TFT touch display
 Panel-free appliance with surface control module
 Electronic temperature control from 30 °C to 300 °C
 Net volume 76 litres

Heating methods

Hot air.
 Eco hot air. Top + bottom heat. Top + 1/3 bottom heat. Top heat. 1/3 top + bottom heat. Bottom heat. Hot air + bottom heat. Hot air + 1/3 bottom heat. Full surface grill + circulated air. Full surface grill. Compact grill. Baking stone function. Roaster function. Dough proofing. Defrosting. Keeping warm.

Handling

Automatic door opening.
 Rotary knob and TFT touch display operation.
 Clear text display.
 Option to save individual recipes (incl. core temperature probe).
 Personalisation of automatic programmes.
 Information key with use indicators.
 Side-opening door opens up to 180° angle.

Features

Three-point core temperature probe with automatic shut-off and estimation of cooking time.
 Automatic programmes.
 Rotisserie function.
 Baking stone socket.
 Actual temperature display.
 Rapid heating.
 Timer functions: cooking time, cooking time end, timer, stopwatch, long-term timer (certified by Star-K).
 60 W halogen light on the top.
 2 x 10 W halogen light on the side.
 Enamelled side shelf supports with 4 tray levels, pyrolysis-safe.

Selected digital services (Home Connect)

Door opening via voice assistant.
 Automatic programmes.
 Remote control and monitoring.
 Recipes.
 Home network integration for digital services (Home Connect) either via cable connection LAN (recommended) or wireless via WiFi.
 The use of the Home Connect functionality depends on the Home Connect services, which are not available in every country. For further information please check: home-connect.com.

Safety

Thermally insulated door with quadruple glazing.

Child lock.
 Safety shut-off.
 Cooled housing with temperature protection.

Cleaning

Pyrolytic system.
 Gaggenau enamel.
 Heated catalyser to clean the oven air.

Planning notes

Door hinge not reversible.
 The facade of the appliance extends 47 mm from the furniture cavity.
 Consider the overhang when planning to open drawers next to the appliance.
 When planning a corner solution, pay attention to the side-opening door and the minimum required distance to the wall.
 To achieve the 550 mm installation depth, the connection cable needs to follow the slanted edge on the lower right hand corner of the housing.
 The mains socket needs to be planned outside the built-in niche.
 The LAN port can be found at the back on the upper right side.

Connection

Energy efficiency class A at a range of energy efficiency classes from A+++ to D.
 Total connected load 3.7 KW.
 Plan a connection cable.
 Plan a LAN cable.
 Power consumption standby/display on 0.7 W.
 Power consumption standby/display off 0.5 W.
 Power consumption standby/network 1.4 W.
 Time auto-standby/display on 20 min.
 Time auto-standby/display off 20 min.
 Time auto-standby/network 20 min.
 Please check the user manual for how to switch off the WiFi module.

When installed next to each other

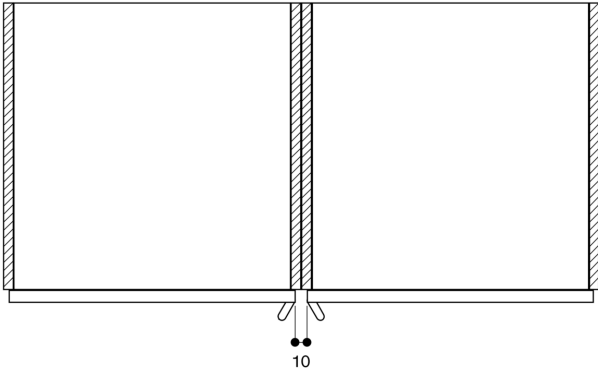

Cross section of the top/bottom door edge gaps

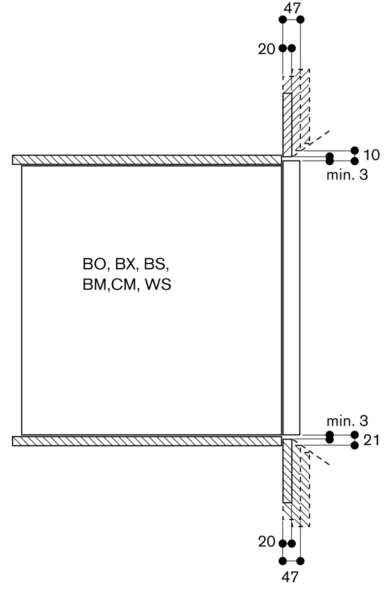

Air inlet cross section at the door edges

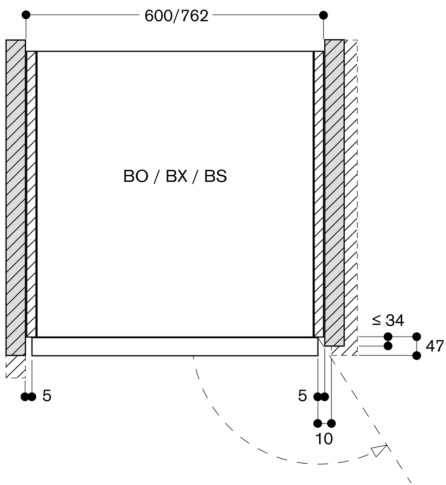

Measurements in mm

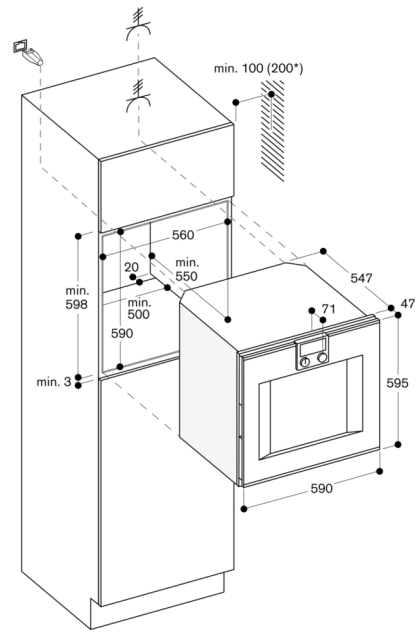

* 200 mm in conjunction with BA 016